

US00D761910S

(12) **United States Design Patent**  
**Beeler**

(10) **Patent No.:** **US D761,910 S**  
(45) **Date of Patent:** **\*\* Jul. 19, 2016**

- (54) **MEMORIAL BOOK**
- (71) Applicant: **Joseph D. Beeler**, Irving, IL (US)
- (72) Inventor: **Joseph D. Beeler**, Irving, IL (US)
- (73) Assignee: **Beeler & Sons Customs, LLC**, Irving, IL (US)
- (\*\*) Term: **14 Years**
- (21) Appl. No.: **29/496,671**
- (22) Filed: **Jul. 16, 2014**
- (51) **LOC (10) Cl.** ..... **19-04**
- (52) **U.S. Cl.**  
USPC ..... **D19/26**
- (58) **Field of Classification Search**  
USPC ..... D5/21, 41; D19/26, 27, 28; D21/485, D21/491  
CPC ..... B42D 1/003; B42D 1/007; B42D 1/06; B42D 1/08; B42D 3/00; B42D 3/04; B42D 3/08; B42D 3/12; B42D 3/18; B42F 5/04  
See application file for complete search history.

- 5,213,370 A \* 5/1993 Hood ..... B42D 3/00 281/29
- 5,490,739 A \* 2/1996 Olson ..... B42D 1/08 281/15.1
- 5,509,746 A \* 4/1996 Ho ..... B42D 1/08 281/33
- 5,662,447 A \* 9/1997 Tsai ..... B42D 3/08 281/222
- D407,432 S \* 3/1999 Tell ..... D19/26
- D413,922 S \* 9/1999 Thomas ..... D19/26

(Continued)

*Primary Examiner* — Celia Murphy  
*Assistant Examiner* — Clare Ann Gannon  
(74) *Attorney, Agent, or Firm* — Polsinelli PC

(57) **CLAIM**

The ornamental design for a memorial book, as shown and described.

**DESCRIPTION**

FIG. 1 is a perspective view of a memorial book showing my new design;  
FIG. 2 is a front elevational view thereof;  
FIG. 3 is a rear elevational view thereof;  
FIG. 4 is a left side elevational view thereof;  
FIG. 5 is a right side elevational view thereof;  
FIG. 6 is a top plan view thereof;  
FIG. 7 is a bottom plan view thereof; and,  
FIG. 8 is an exploded perspective view thereof; shown in an opened position.  
The broken lines showing hinges in FIGS. 2-4; 6 and 7; and an internal block in FIG. 8, are included for the purpose of illustrating portions of the memorial book that form no part of the claimed design.

**1 Claim, 4 Drawing Sheets**

(56) **References Cited**

U.S. PATENT DOCUMENTS

- 43,135 A \* 6/1864 Safford ..... B42D 1/08 281/38
- D159,614 S \* 8/1950 Hersh ..... D19/26
- 4,001,960 A \* 1/1977 Holson ..... B42F 5/00 281/31
- 4,164,085 A \* 8/1979 Steeb ..... B42C 7/00 281/31
- D273,796 S \* 5/1984 Milden ..... D19/27
- D293,335 S \* 12/1987 Egly ..... D19/27
- 4,822,195 A \* 4/1989 Lu ..... A47G 1/14 40/726
- 4,825,573 A \* 5/1989 Roberts ..... B42F 5/04 40/733
- 4,830,404 A \* 5/1989 Lu ..... B42D 1/08 281/2
- 4,890,872 A \* 1/1990 Parrotta ..... A45D 40/0087 132/317

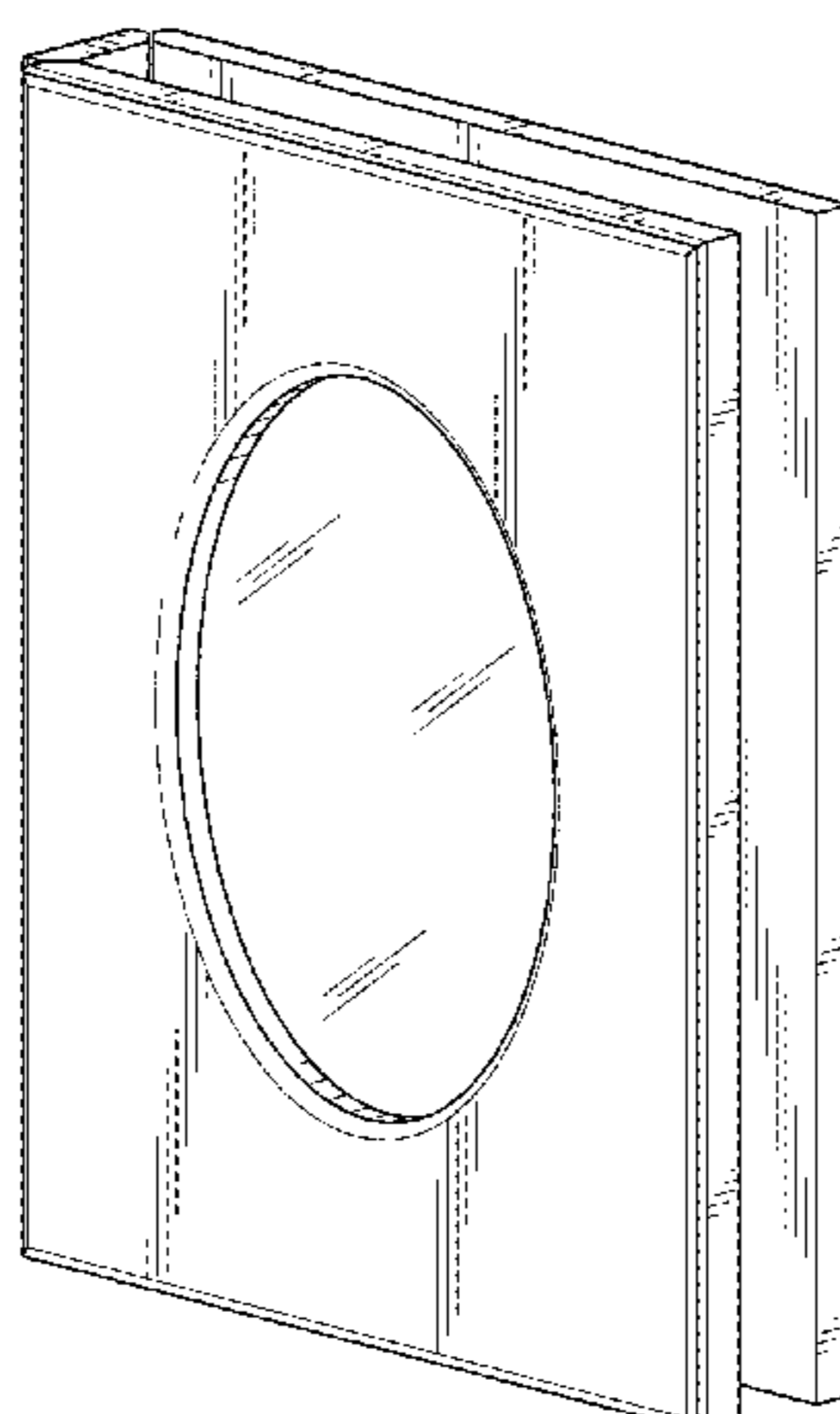

# US D761,910 S

Page 2

(56)

## References Cited

### U.S. PATENT DOCUMENTS

6,142,696 A *	11/2000	Tan	.....	B42D 1/08 281/21.1
6,145,882 A *	11/2000	Fu	.....	B29C 65/02 156/201
D559,906 S *	1/2008	Sakaguchi	.....	D19/26
7,487,999 B1 *	2/2009	Broyles	.....	B42F 3/00 281/19.2
D726,817 S *	4/2015	Lovern	.....	D19/28
2007/0200334 A1 *	8/2007	Thomsen	.....	B42D 3/08 281/15.1
2008/0211220 A1 *	9/2008	Boxer	.....	B42D 3/18 281/21.1
2009/0284002 A1 *	11/2009	Miranti	.....	B42F 7/06 281/22
2010/0026915 A1 *	2/2010	Pozin	.....	B42D 1/08 348/838
2012/0043748 A1 *	2/2012	Huang	.....	B42D 3/08 283/64

\* cited by examiner

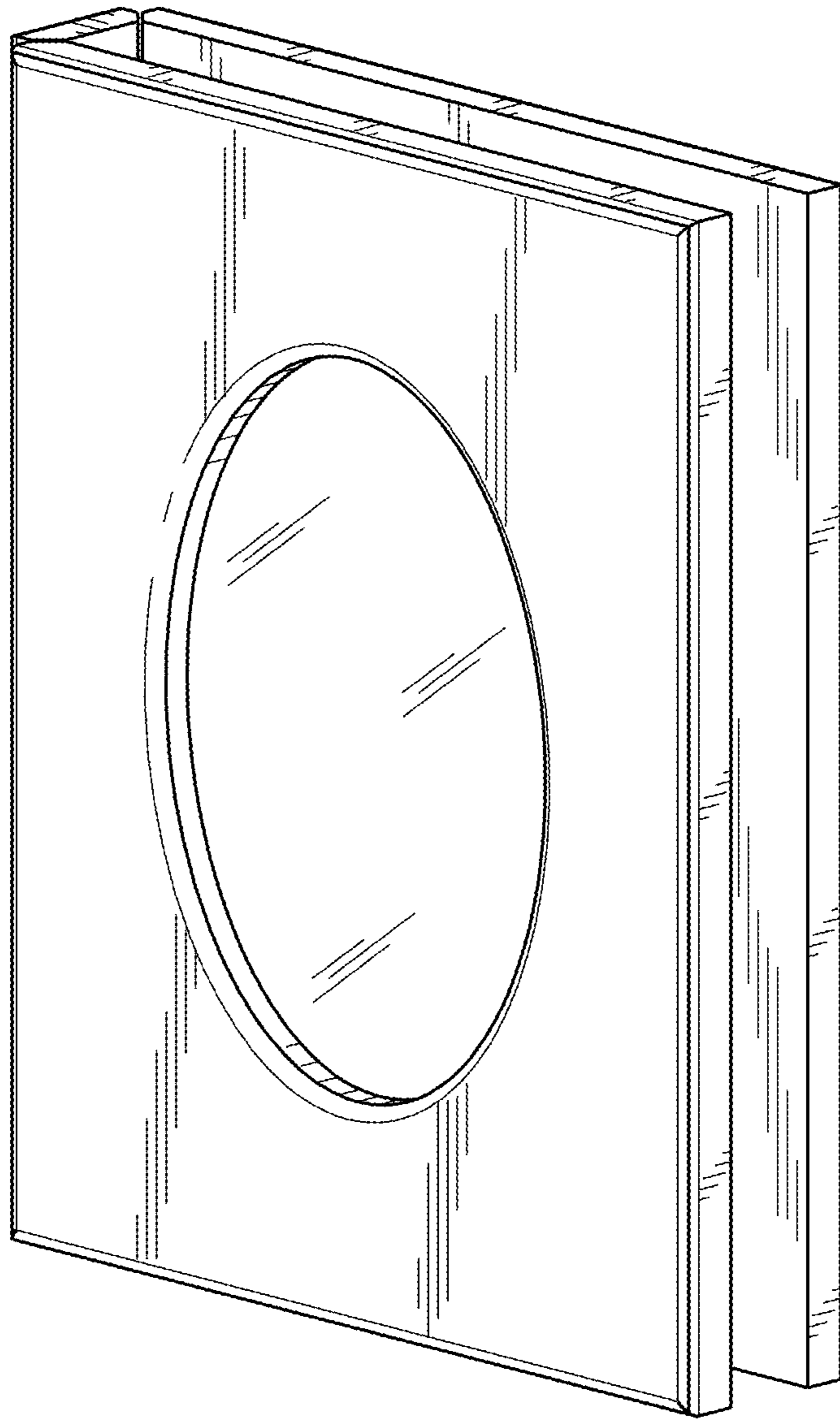

FIG. 1

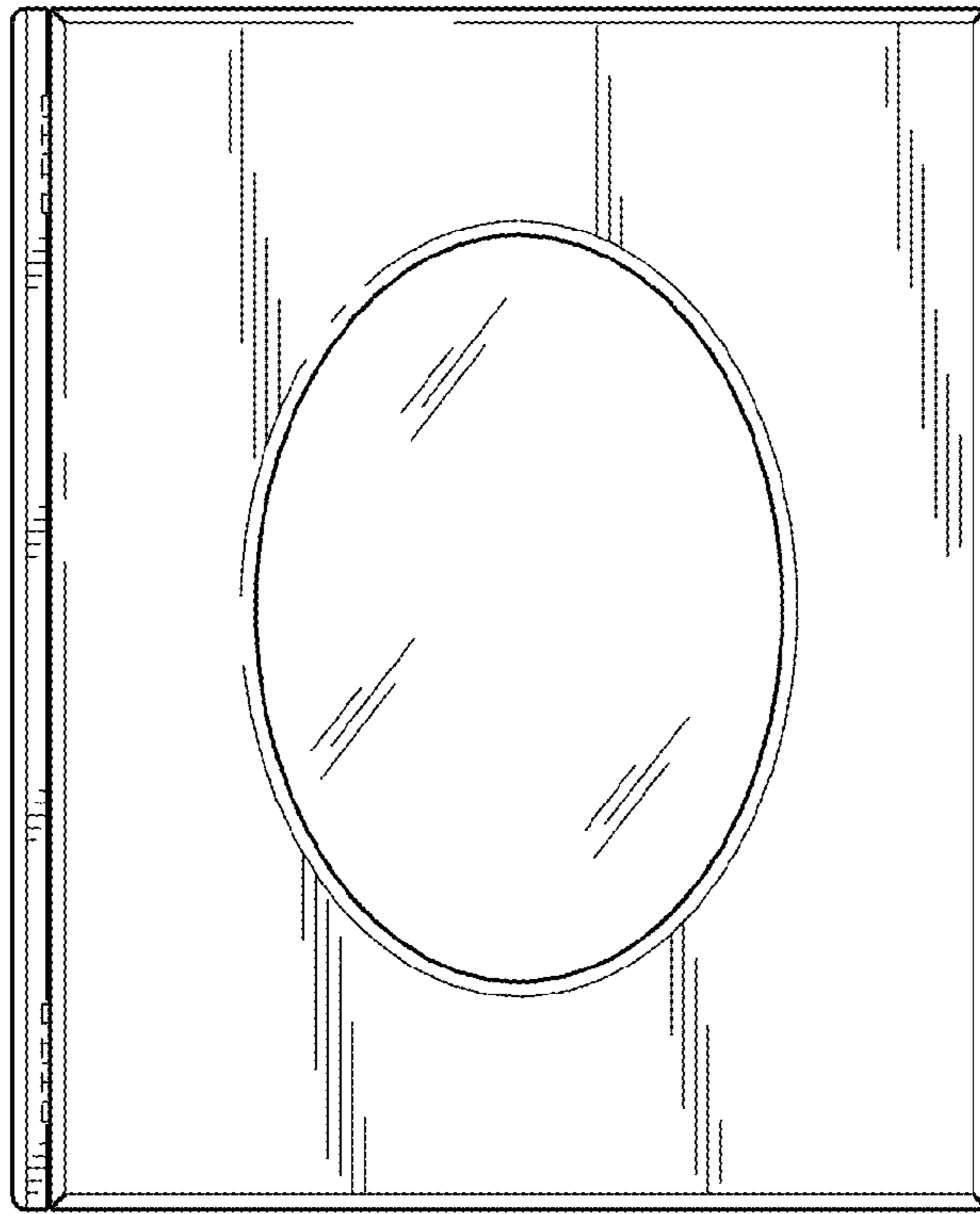

FIG. 2

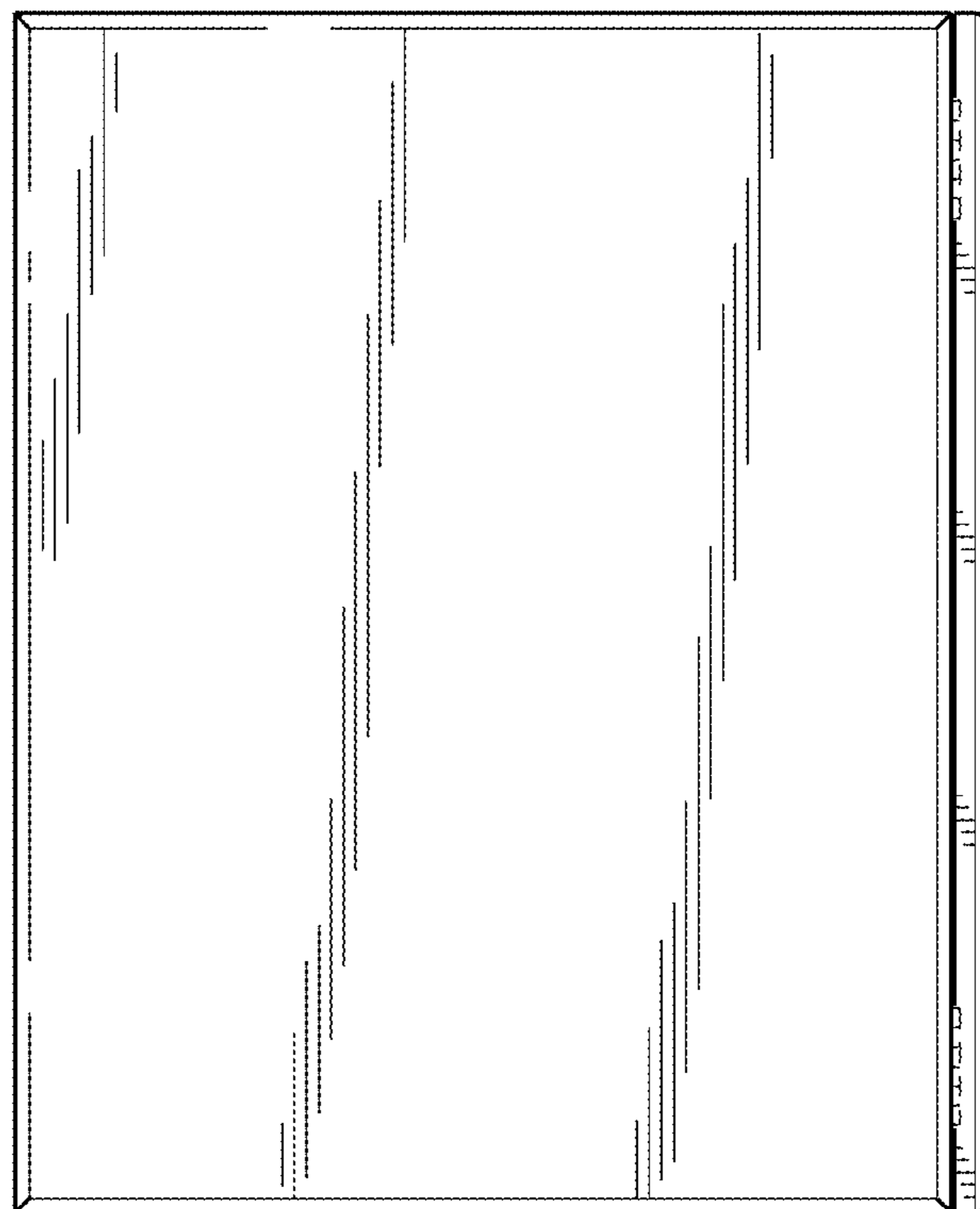

FIG. 3

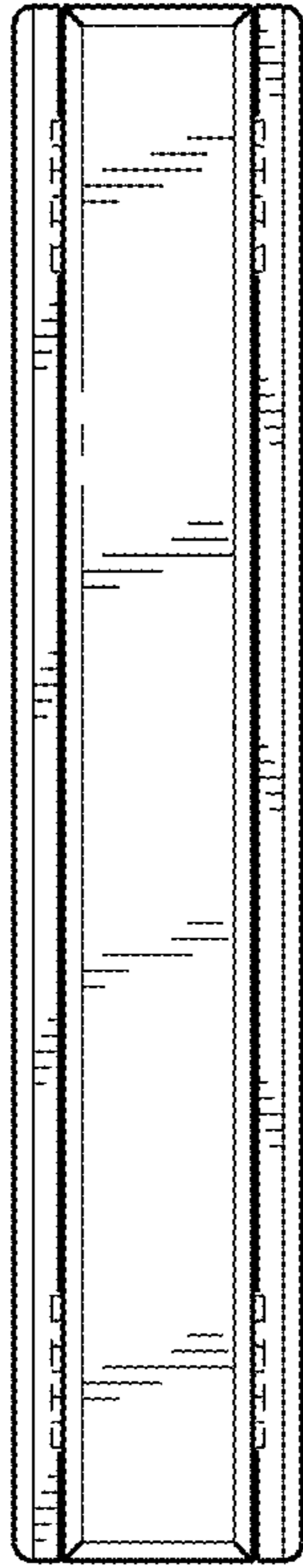

FIG. 4

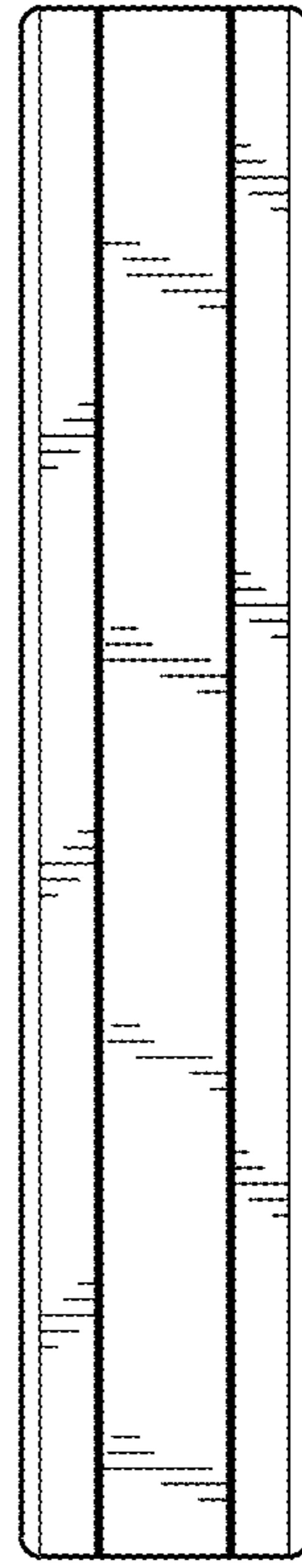

FIG. 5

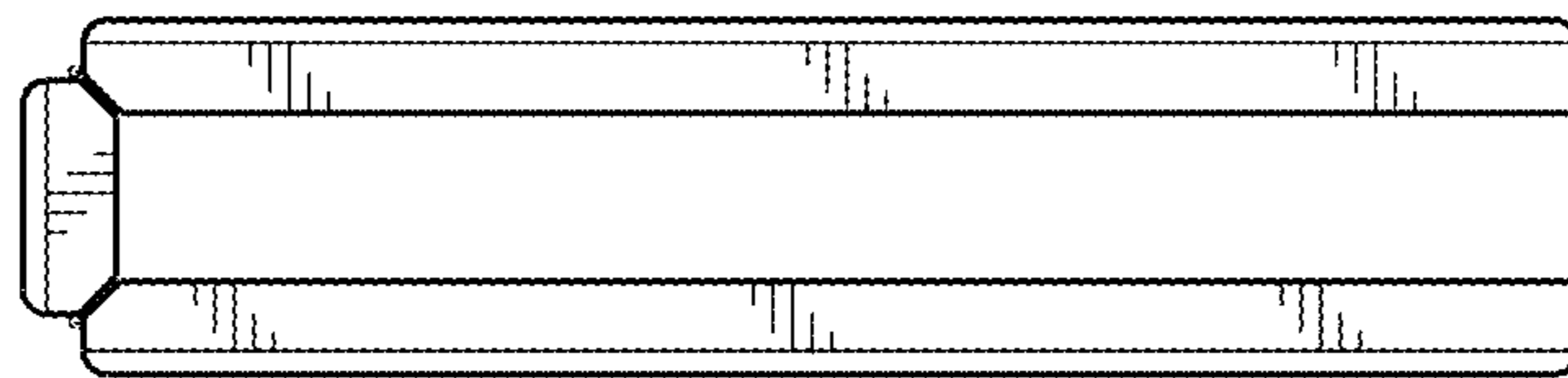

FIG. 6

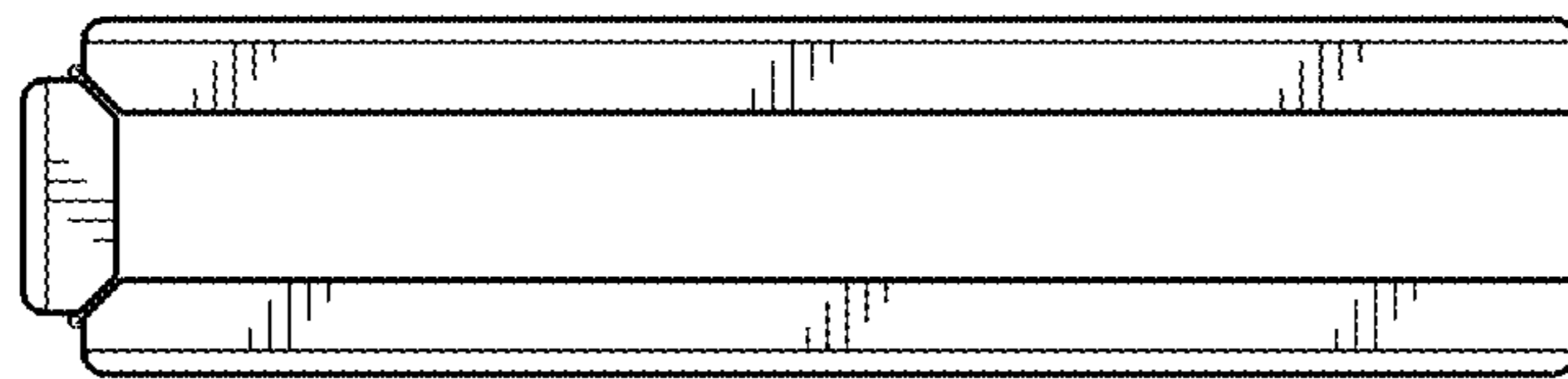

FIG. 7

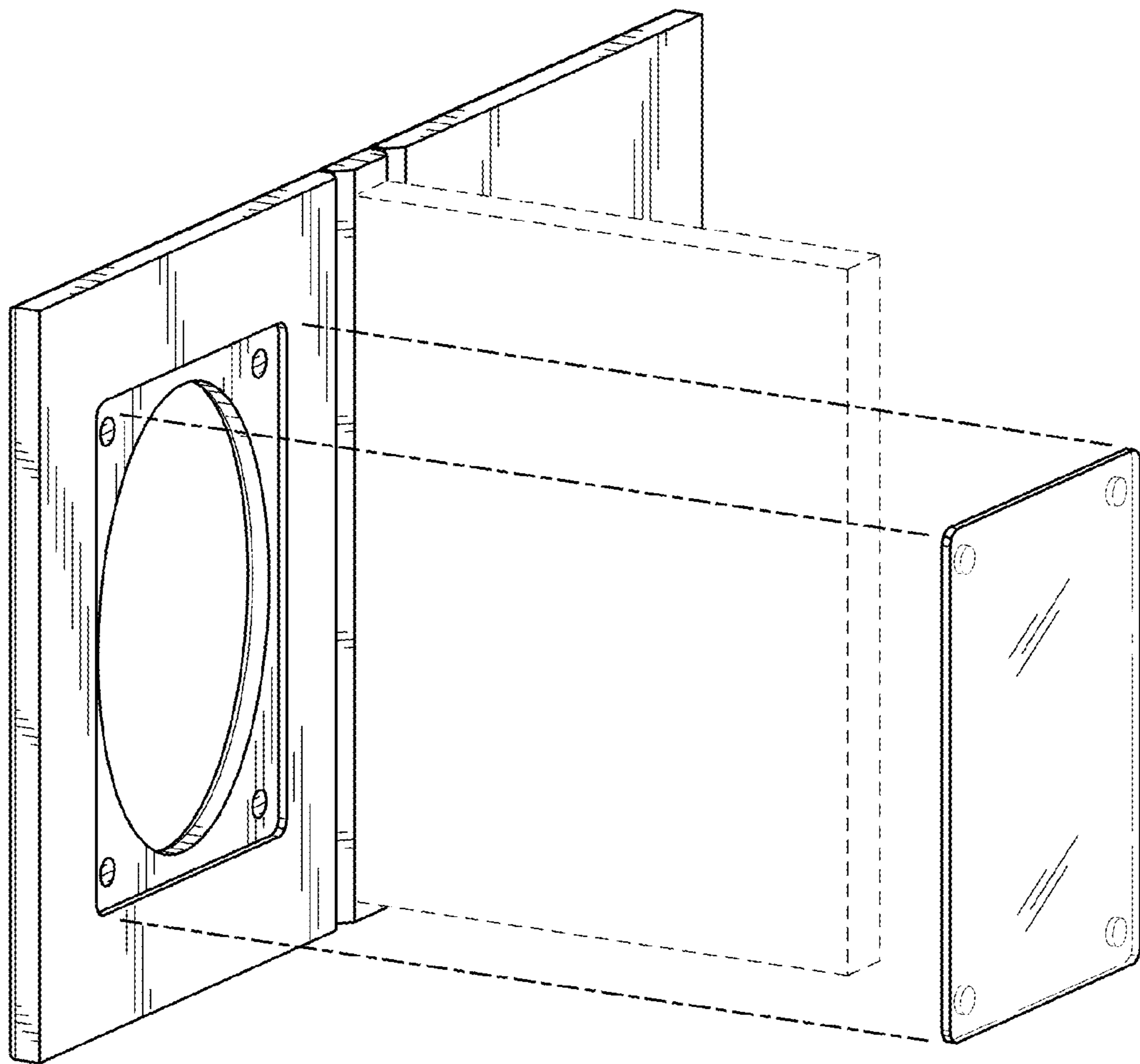

FIG. 8