



US00D761567S

(12) **United States Design Patent**
Uchida

(10) **Patent No.:** **US D761,567 S**
(45) **Date of Patent:** **** Jul. 19, 2016**

(54) **ELECTRIC TOOTHBRUSH**
(71) Applicant: **Panasonic Intellectual Property Management Co., Ltd., Osaka (JP)**
(72) Inventor: **Ryota Uchida, Shiga (JP)**
(73) Assignee: **Panasonic Intellectual Property Management Co., Ltd., Osaka (JP)**

D353,490 S * 12/1994 Hartwein D13/108
D388,958 S * 1/1998 Hartwein D4/101
D500,208 S * 12/2004 Vu D4/101
D533,720 S * 12/2006 Vu D4/101
D636,604 S * 4/2011 Zhuan D4/101
D688,464 S * 8/2013 Hara D4/101
D696,023 S * 12/2013 Gebski D4/101
D696,517 S * 12/2013 Gebski D4/101
D701,388 S * 3/2014 Chuanzhou D4/101
D718,056 S * 11/2014 Masee D4/101
D740,792 S * 10/2015 Jobetto D14/225

(**) Term: **15 Years**

FOREIGN PATENT DOCUMENTS

(21) Appl. No.: **29/527,623**

JP D1212183 7/2004
JP D1269845 5/2006
JP D1432629 1/2012

(22) Filed: **May 20, 2015**

* cited by examiner

(30) **Foreign Application Priority Data**

Mar. 16, 2015 (JP) 2015-005573

Primary Examiner — Catheri Oliver-Garcia

(51) **LOC (10) Cl.** **04-02**

Assistant Examiner — Rebekah Caruso

(52) **U.S. Cl.**

(74) *Attorney, Agent, or Firm* — PIPM; Kerry S. Culpepper

USPC **D4/101**

(57) **CLAIM**

(58) **Field of Classification Search**

USPC D4/100–102, 104–118, 124–125,
D4/127–132, 136, 138

I claim the ornamental design for an electric toothbrush, as shown and described.

CPC A46B 5/00; A46B 5/0004; A46B 5/0008;
A46B 5/0012; A46B 5/002; A46B 5/0095;
A46B 9/04; A46B 11/0006; A46B 2200/1066;
A61B 17/24; A61C 17/16

DESCRIPTION

See application file for complete search history.

FIG. 1 is a front perspective view of an electric toothbrush of the present invention;
FIG. 2 is a front view thereof;
FIG. 3 is a first side view thereof;
FIG. 4 is a second side view thereof;
FIG. 5 is a rear view thereof;
FIG. 6 is a top view thereof; and,
FIG. 7 is a bottom view thereof.

(56) **References Cited**

U.S. PATENT DOCUMENTS

D203,927 S * 3/1966 Rogers D4/101
D324,774 S * 3/1992 Elkerbout D4/101

1 Claim, 7 Drawing Sheets

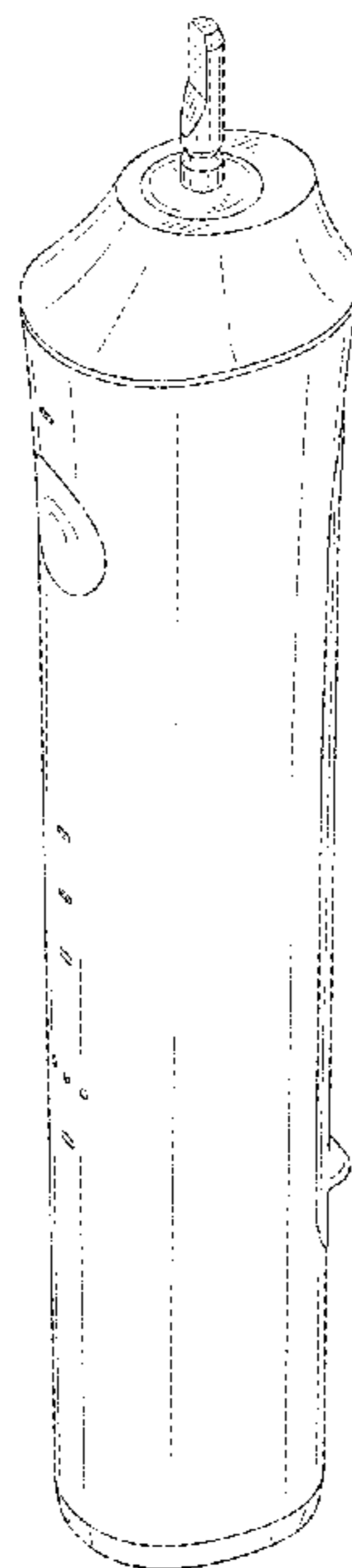

FIG. 1

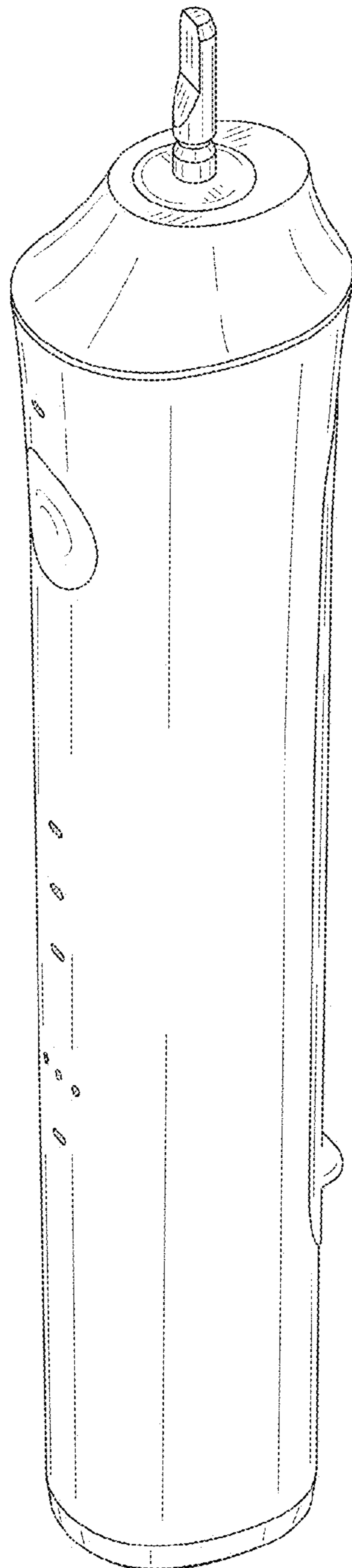

FIG. 2

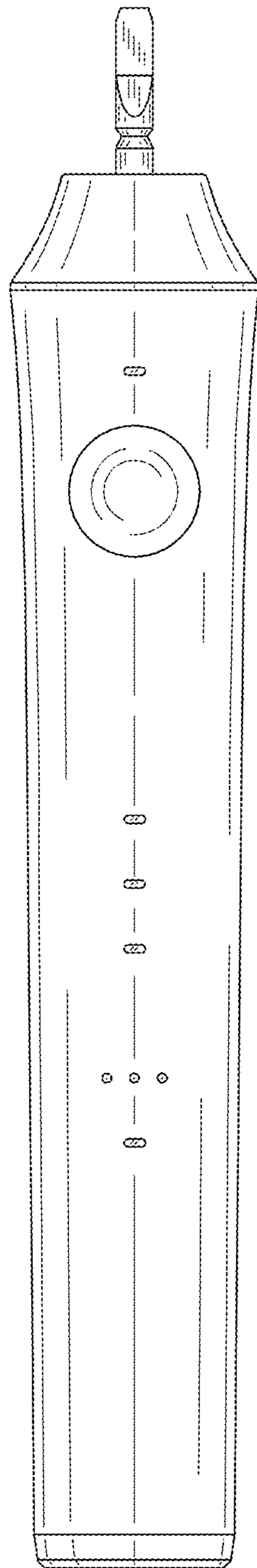

FIG. 3

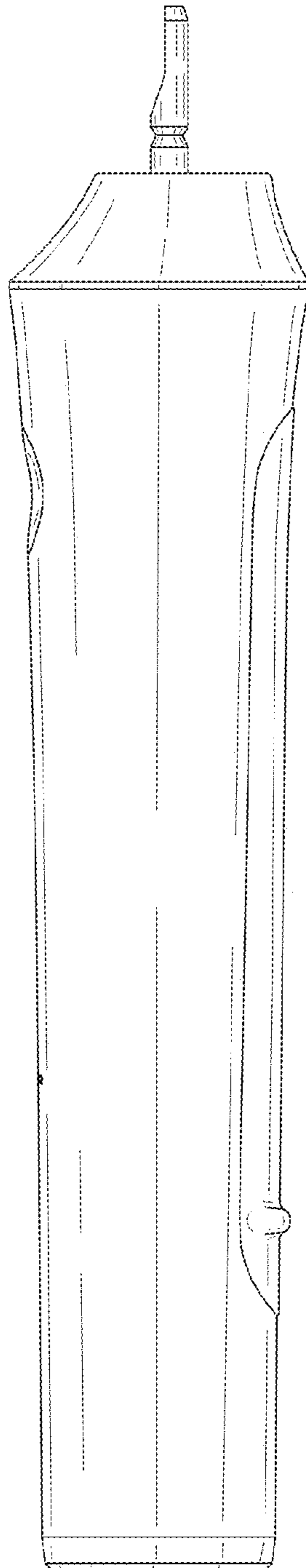

FIG. 4

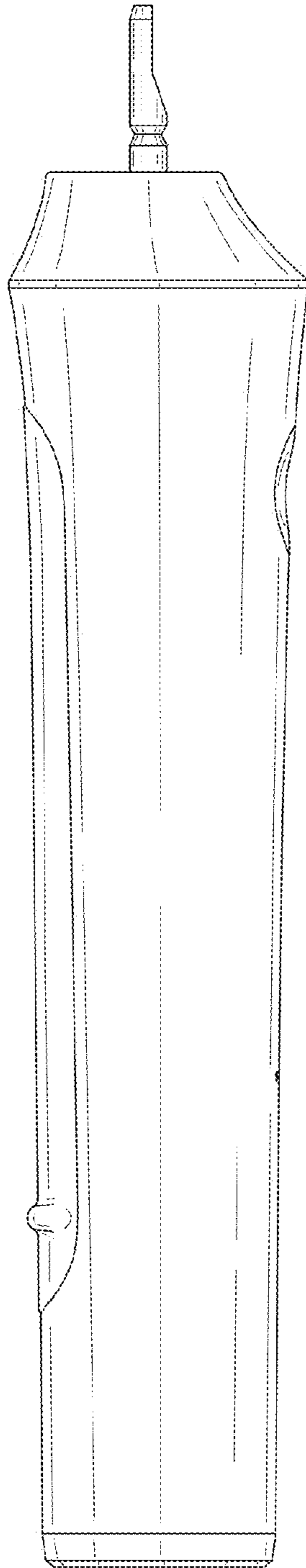

FIG. 5

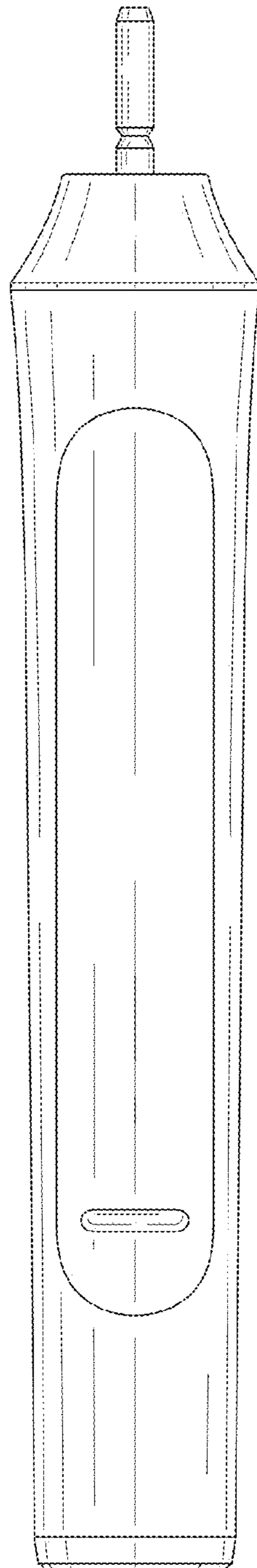

FIG. 6

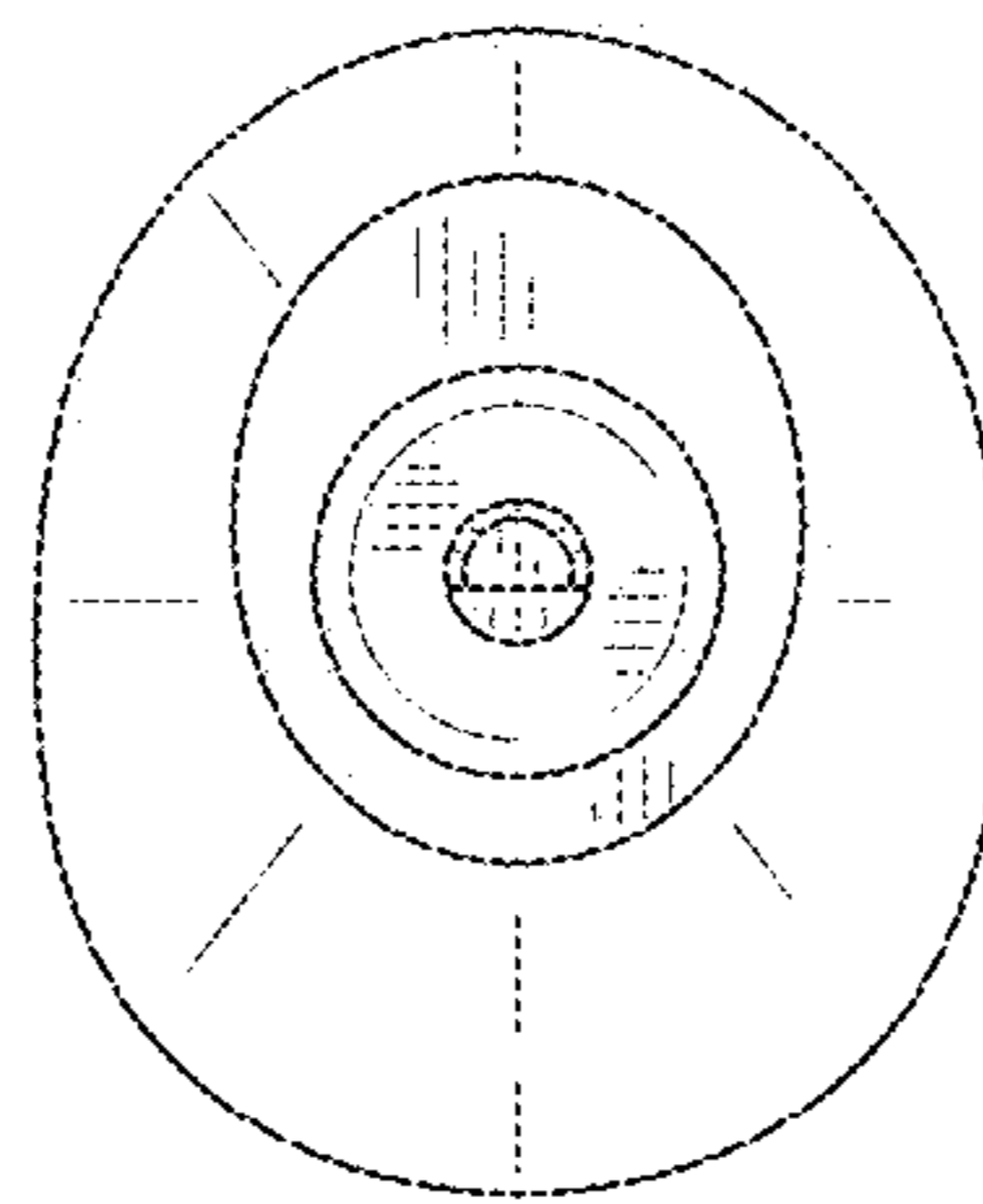

FIG. 7

