



US00D761535S

(12) **United States Design Patent**
Gavrieli et al.

(10) **Patent No.:** **US D761,535 S**
(45) **Date of Patent:** **** Jul. 19, 2016**

- (54) **SINGLE-SOLE SHOE**
- (71) Applicant: **Gavrieli Brands, LLC**, Beverly Hills, CA (US)
- (72) Inventors: **Kfir Gavrieli**, Los Angeles, CA (US);
Dikla Gavrieli, Los Angeles, CA (US)
- (73) Assignee: **Gavrieli Brands LLC**, Beverly Hills, CA (US)
- (**) Term: **14 Years**
- (21) Appl. No.: **29/493,456**
- (22) Filed: **Jun. 10, 2014**
- (51) **LOC (10) Cl.** **02-04**
- (52) **U.S. Cl.**
USPC **D2/939**
- (58) **Field of Classification Search**
USPC D2/896, 900, 919-921, 925, 939, 947,
D2/950, 969, 971; 36/1, 83, 8.1-8.3, 9 R,
36/45-58, 104, 108, 76 R
CPC A43B 21/00; A43B 21/02; A43B 21/06;
A43B 9/14; A43B 1/0045; A43B 13/10;
A43B 13/12; A43B 23/06; A43B 23/07;
A43B 1/0036; A43B 5/12
See application file for complete search history.

- 2,268,777 A 1/1942 Scholl
- D133,819 S * 9/1942 Harris D2/939
- D135,791 S 6/1943 Beebe
- 2,323,563 A 7/1943 Nugent
- 2,342,882 A 2/1944 Meltzer
- D141,871 S 7/1945 Braun

(Continued)

FOREIGN PATENT DOCUMENTS

- DE 20 2006 000230 U1 5/2007
- GB 2443937 A 5/2008
- GB 2 446 205 A 8/2008
- TW D119165 10/2007

OTHER PUBLICATIONS

Examination Report for AU 341324, 3 pgs., dated Oct. 24, 2012.

(Continued)

Primary Examiner — Dominic Simone
(74) *Attorney, Agent, or Firm* — Morgan, Lewis & Bockius LLP

(57) **CLAIM**
The ornamental design for a single-sole shoe, as shown and described.

DESCRIPTION

FIG. 1 is a perspective view of our new design of a single-sole shoe;
FIG. 2 is a first side view thereof;
FIG. 3 is a second side view thereof;
FIG. 4 is a top view thereof;
FIG. 5 is a bottom view thereof;
FIG. 6 is a front view thereof; and,
FIG. 7 is a back view thereof.
The broken lines illustrating half-moon patch, the heel stripe, and the channel on the sole in the above described Figures are for illustrative purposes only and form no part of the claimed design.

1 Claim, 6 Drawing Sheets

- (56) **References Cited**
U.S. PATENT DOCUMENTS

249,086 A 11/1881 Pienovi
773,850 A 11/1904 Cooper et al.
830,941 A 9/1906 Walden
1,208,209 A 12/1916 Prince
1,214,666 A 2/1917 Ford
1,519,009 A 12/1924 Reina
1,525,848 A * 2/1925 Bonaventure A43B 5/12
36/113

1,587,377 A 6/1926 Grosjean
1,650,466 A 11/1927 Righter
2,224,590 A 12/1940 Boivin

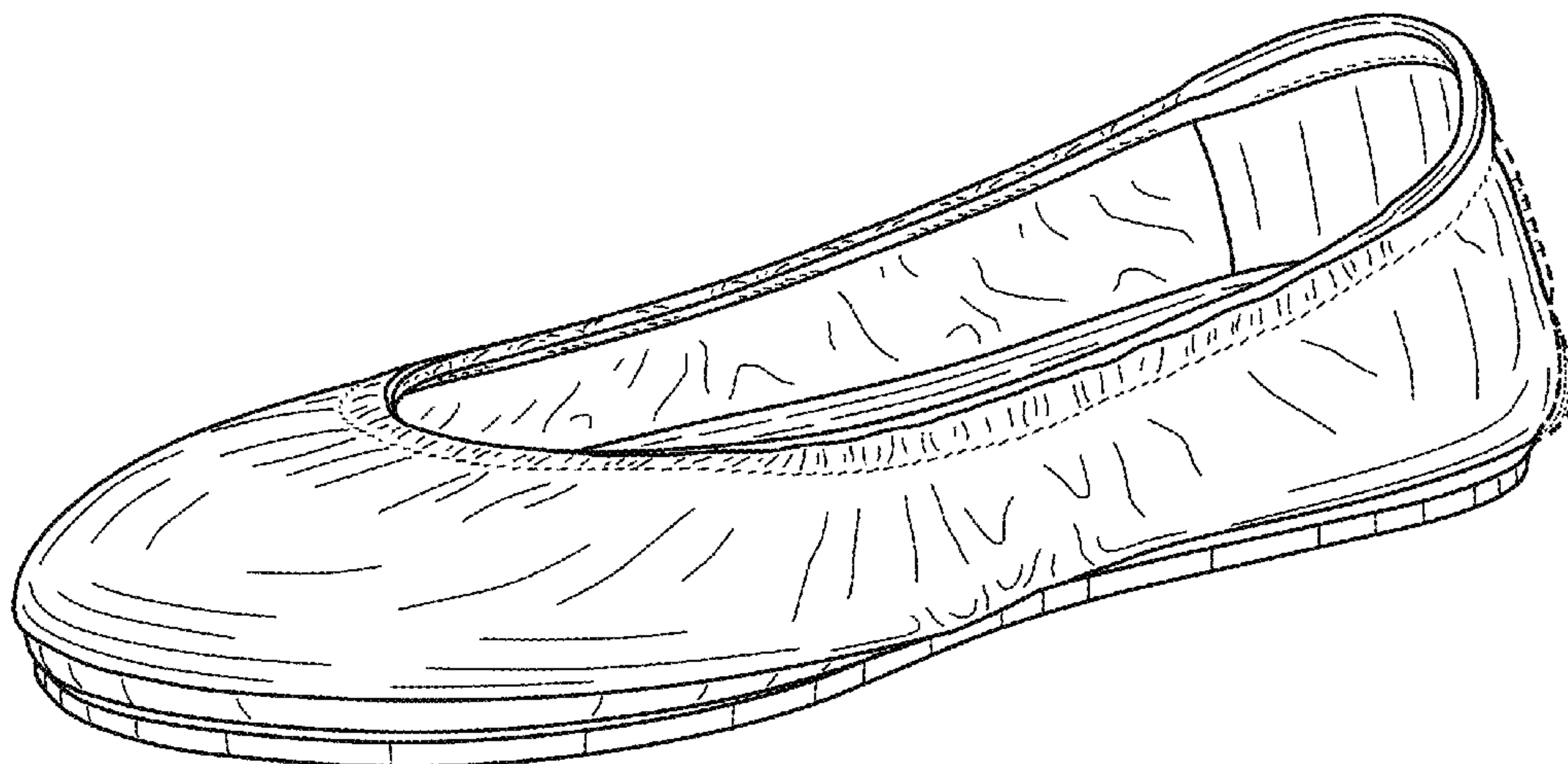

(56)

References Cited

U.S. PATENT DOCUMENTS

2,383,585 A	8/1945	Bindner		D612,140 S	3/2010	Moon	
D149,685 S *	5/1948	Sandler	D2/935	D612,141 S	3/2010	Moon	
D150,729 S *	8/1948	Sandler	D2/923	7,694,435 B1	4/2010	Kiser et al.	
D166,090 S *	3/1952	Maling	D2/897	D615,737 S	5/2010	Feller	
2,772,488 A	12/1956	Meltzer		7,735,244 B1	6/2010	Ameche	
2,904,814 A	9/1959	Scholl		7,743,530 B2	6/2010	Truelsen	
3,148,378 A	9/1964	Tibbitts		D618,891 S	7/2010	McClaskie	
D200,897 S *	4/1965	Mitchell	D2/919	7,757,408 B2	7/2010	McClaskie	
D220,464 S	4/1971	Hayashi		D630,829 S	1/2011	Weisner	
D247,396 S *	3/1978	Schlerth	D2/939	D632,881 S	2/2011	Rosenberg	
4,412,393 A	11/1983	Terlizzi, Jr. et al.		7,926,203 B2	4/2011	Wilkenfeld	
D275,525 S	9/1984	Nakao		7,966,747 B2	6/2011	Wilkenfeld et al.	
4,674,206 A	6/1987	Lyden		D640,861 S	7/2011	Wilkenfeld	
D295,692 S *	5/1988	Zuidema	D2/950	8,020,320 B2	9/2011	Gillespie	
D300,085 S	3/1989	Ito et al.		8,127,468 B2	3/2012	Morgan	
RE33,018 E	8/1989	Ostrander		D657,543 S	4/2012	Bove	
4,899,412 A	2/1990	Ganon		D659,960 S	5/2012	Bizzo	
D316,773 S	5/1991	Valle		8,230,619 B2	7/2012	Salvatelli	
5,012,541 A	5/1991	Ganon		D664,755 S	8/2012	Gavrieli et al.	
D339,669 S *	9/1993	Miller	D2/919	D665,157 S	8/2012	Wu	
5,282,326 A	2/1994	Schroer, Jr. et al.		8,240,067 B2	8/2012	Sussmann	
5,421,050 A	6/1995	Laganas		8,245,420 B2	8/2012	Wilson	
5,699,629 A	12/1997	Munschy		D668,027 S	10/2012	Millieret	
5,746,014 A	5/1998	Tanemoto		D668,438 S	10/2012	Millieret	
D420,785 S	2/2000	Perez		D668,847 S *	10/2012	Gavrieli	D2/925
6,055,745 A	5/2000	Endoh		D668,848 S *	10/2012	Gavrieli	D2/925
6,076,284 A	6/2000	Terlizzi		D668,849 S	10/2012	Pozzi	
6,189,239 B1	2/2001	Gasparovic et al.		D668,850 S	10/2012	Pozzi	
6,338,207 B1	1/2002	Chang		D672,542 S	12/2012	Gray et al.	
D457,292 S *	5/2002	Sessa	D2/949	D676,634 S *	2/2013	Gavrieli	D2/925
D461,947 S	8/2002	Merceron		D681,927 S *	5/2013	Gavrieli	D2/925
D476,798 S	7/2003	Reynolds et al.		D681,928 S *	5/2013	Gavrieli	D2/925
6,588,124 B2	7/2003	Morrone		D681,929 S *	5/2013	Gavrieli	D2/925
D498,041 S	11/2004	McClaskie		D683,936 S *	6/2013	Gavrieli	D2/925
D500,191 S *	12/2004	Belley	D2/969	8,468,723 B2	6/2013	Malka-Harari	
D501,706 S	2/2005	McClaskie		8,510,975 B2	8/2013	Krikelis	
6,857,203 B2	2/2005	Minden		D688,853 S *	9/2013	Gavrieli	D2/925
6,895,693 B2	5/2005	Baruck		D688,854 S *	9/2013	Gavrieli	D2/925
6,978,557 B2	12/2005	Lee		D688,855 S *	9/2013	Gavrieli	D2/925
7,032,327 B1	4/2006	Tartaglia et al.		D689,270 S *	9/2013	Gavrieli	D2/925
7,036,244 B1	5/2006	Finch		D689,271 S *	9/2013	Gavrieli	D2/925
D527,513 S	9/2006	Della Valle		D689,272 S *	9/2013	Gavrieli	D2/925
D529,513 S *	10/2006	Aketa	D15/5	D690,914 S *	10/2013	Gavrieli	D2/925
D531,790 S	11/2006	Wurzburg		D690,915 S *	10/2013	Gavrieli	D2/925
D534,341 S *	1/2007	Choi	D2/896	D696,500 S	12/2013	Hunt	
D542,513 S	5/2007	Amado et al.		D699,424 S	2/2014	Hamm	
D556,990 S	12/2007	Cabados		8,661,714 B2	3/2014	Sussmann	
7,337,558 B2	3/2008	Terlizzi et al.		8,973,287 B2	3/2015	Shibata	
D567,485 S	4/2008	James		2002/0078591 A1	6/2002	Morrone	
D570,488 S	6/2008	Kirksey et al.		2002/0129519 A1	9/2002	Cahan	
D571,084 S	6/2008	Comeau		2003/0070319 A1	4/2003	Minden	
D571,548 S	6/2008	Seamans		2003/0121176 A1	7/2003	Baruck	
D571,989 S	7/2008	Siegal		2004/0025377 A1	2/2004	Brannon	
D580,640 S	11/2008	Wurzburg		2005/0022421 A1	2/2005	Bruckner	
D582,638 S	12/2008	Ringholz		2005/0115115 A1	6/2005	Lacey	
7,496,982 B2	3/2009	Clark et al.		2005/0217148 A1	10/2005	Connolly et al.	
7,506,459 B2	3/2009	Grisoni et al.		2005/0262734 A1	12/2005	Cheng	
D591,031 S	4/2009	Cofinco		2006/0086005 A1	4/2006	Yerian	
D593,295 S *	6/2009	Belley	D2/969	2006/0156576 A1	7/2006	Sloan	
D593,297 S *	6/2009	Belley	D2/969	2007/0074424 A1	4/2007	Lin	
D593,307 S *	6/2009	Belley	D2/969	2007/0204482 A1	9/2007	Gibson-Collinson	
D599,093 S *	9/2009	Issler	D2/925	2007/0204483 A1	9/2007	Kirsch et al.	
D604,030 S	11/2009	Wilson		2008/0052964 A1	3/2008	Taylor	
D607,194 S	1/2010	Zagula		2008/0086912 A1	4/2008	Wilkenfeld	
D610,332 S	2/2010	Raichle		2008/0110059 A1	5/2008	Kuramoto et al.	
D610,785 S	3/2010	Smith		2009/0019732 A1	1/2009	Sussmann	
				2009/0193685 A1	8/2009	Wilson	
				2009/0205222 A1	8/2009	Mclinden	
				2009/0272009 A1	11/2009	Weisner et al.	
				2010/0011625 A1	1/2010	Percival	
				2010/0018080 A1	1/2010	Smith	
				2010/0050469 A1	3/2010	Chen	
				2010/0095557 A1	4/2010	Jarvis	
				2010/0115793 A1	5/2010	Kraisosky	
				2010/0122475 A1	5/2010	Purrington	
				2010/0146822 A1	6/2010	MacGregor	
				2010/0212186 A1	8/2010	Cheng	

(56)

References Cited

U.S. PATENT DOCUMENTS

2010/0275462 A1 11/2010 Pucci
 2010/0281713 A1 11/2010 Pantazes
 2015/0089843 A1 4/2015 Gavrieli

OTHER PUBLICATIONS

Letter from TMI and Associates with Office Action, 2 pgs, dated Sep. 19, 2012 <http://www.payless.com/store/?&TLC=Womens&SLC=WomensNewArrivals&BLC=WomensNewArrivalsNewArrivals&With+Regular&ItemCode=601318&LotNumber=062642&Type=Adult&Popularity=637&Descriptvein>.

Taiwanese Office Action for TW 101300726, 10 pgs., dated Sep. 6, 2012.

“The Love List, Tieks by Gavrieli—Foldable Ballet Flats,” <http://thelovelist-carly.blogspot.com.au/2010/09/tieks-by-gavrieli-foldable-ballet.html>, 3 pgs., Sep. 12, 2010.

“Tieks by Gavrieli,” <http://tieks.com>, 1 pg., retrieved Mar. 13, 2013 from URL.

“Try It Mummy!, Tieks by Gavrieli,” <http://tryitmummy.blogspot.com.au/2010/12/tieks-by-gavrieli.html>, 4 pgs., Dec. 9, 2010.

“Wearability—Real People Style, What came first, the City Flat or the Tieks,” <http://wearability.posterous.com/what-came-first-the-city-flat-or-the-tieks>, 4 pgs., Aug. 29, 2010.

“The Ballet Flat . . . Reinvented; Ballet Flats . . . with a Bonus; Step Into Tieks; Going Places? Take Tieks,” <http://web.archive.org/web/2010052004346/http://www.tieks.com/>; 4 pgs., May 24, 2010.

“Tieks—Comfortable designer flats you can fit in your purse and wear all day, every day,” <http://web.archive.org/web/20110731151555/http://tieks.com>; 6 pgs., Jul. 31, 2011.

“58th Annual Emmy Awards,” http://spoonsforksandfashion.blogspot.com/2006_08_01_archive.html, depicting Nine West flats, 11 pgs., Aug. 1, 2006.

Pictures of Nine West flats sold in 2006, 3 pgs.

“I Love a Good Ballet Flat!,” <http://dressupfiles.com/i-love-a-good-ballet-flat>, depicting Sue London flats, 4 pgs., Sep. 3, 2010.

Pictures of Sue London flats sold in 2010, 2 pgs.

“Miss Cathie Reviews: The Yosi Samra Foldable Ballet Flat . . .,” <http://www.misscathie.com/2010/01/miss-cathie-reviews-the-yosi-samra-foldable-ballet-flat/>, depicting Yosi Samra flats, 7 pgs., Jan. 2010.

Pictures of Yosi Samra flats sold in 2010, 2 pgs.

“Goodbye two thousand ten,” http://emmajoyrussell.blogspot.com/2010_12_01_archive.html, depicting Gap flats, 39 pgs., Dec. 1, 2010.

Pictures of Gap flats available for sale in 2010, 9 pgs.

“Our newest design of folding flats-Pink,” <https://fitinclouds.wordpress.com/2010/05/16/our-newest-design-of-folding-flats-pink/>, depicting Fit in Clouds flats, 1 pg., May 16, 2010.

“Fit in Clouds Satin Folding Shoes,” <http://www.goodhousekeeping.com/product-reviews/clothing/best-ballet-flats/fit-in-clouds-satin-foldable-ballet-flats>, depicting Fit in Clouds flats, 1 pg., Aug. 2013.

Pictures of Fit in Clouds flats available for sale in 2011, 4 pgs.

“Shoes for Standing,” <https://truthinshoes.wordpress.com/2008/07/depicting-Sam-&Libby-flats>, 2 pgs., Jul. 31, 2008.

“Target Designer Collaboration: Announcing Sam & Libby Shoes for Target,” <http://www.therecessionita.com/2012/11/target-designer-collaboration-announcing-sam-libby-shoes-for-target.html>, depicting Sam & Libby flats, 1 pg., Nov. 26, 2012.

Pictures of Sam & Libby flats available for purchase in 2011, 5 pgs.
 “Save your soles with Citisoles ballet flats,” <http://glamazondiaries.com/2009/07/save-your-soles-with-citisoles-ballet-flats>, depicting Citisoles flats, 3 pgs., Jul. 2009.

Pictures of Citisoles flats available for purchase in 2009, 3 pgs.

“#16 Corso Como Delicious Pumps Review and Giveaway!,” <http://www.mommatoldmeblog.com/2011/01/16-corso-como-deleicious-pumps-review.html>, depicting Corso Como flats, 8 pgs., Jan. 16, 2011.

Pictures of Corso Como flats available for sale in 2011, 3 pgs.

“jil-sander-navy-lead-ballet-flats-product . . .,” www.ebay.com, depicting Jil Sander flats, 4 pgs., Nov. 2013.

Pictures of Jil Sander flats available for sale in 2011, 3 pgs.

“Spare Soles: Shoes That Roll-up & Fold-up,” <http://herpackinglist.com/2011/01/spare-soles-shoes/>, depicting Spare Soles flats, 2 pgs., Jan. 2011.

Pictures of Spare Soles flats available for sale in 2011, 5 pgs.

The Original Rollable, Foldable ballet flats with matching wristlet—Spare Soles, <http://herpackinglist.com/2011/01/spare-soles-shoes/>, depicting Roll-Upz Spare Soles flats, 2 pgs., Jan. 2011.

Pictures of Roll-Upz by Spare Soles flats available for sale in 2011, 6 pgs.

“The Cutest Blog, Preppy 50 and Loving Lilly, Ballet Flat Delight,” <http://preppy50andlovinglilly.blog.spot.com/2011/02/ballet-flat-delight.html>, depicting Henri Bendel flats, 13 pgs., Feb. 19, 2011.

Pictures of Henri Bendel flats available for sale in 2011, 4 pgs.

“Mumsnet by parents for parents,” http://www.mumsnet.com/Talk/style_and_beauty/a1612000-Anyone-tried-Redfoot-Flatmates-foldable-ballet-pumps, depicting Redfoot Flatmates flats, 1 pg, Nov. 14, 2012.

Pictures of Redfoot Flatmates flats available for sale in 2011, 6 pgs.

“Amazon.com: Customer Reviews: Bloch London Women’s Lux Ballet Flat,” <http://www.amazon.com/Bloch-London-Womens-Ballet-Flat/product-reviews/B004LWP7YW>, depicting Bloch London flats, 4 pgs., Dec. 11, 2011.

Pictures of Bloch London flats offered for sale in 2011, 11 pgs.

“h&m foldable leopard print flat,” <http://845shops.wordpress.com/2011/06/16/flats-for-7-bucks/shoe1/>, depicting h&m flats, 3 pgs., Jun. 16, 2011.

Pictures of h&m foldable flats offered for sale in 2011, 4 pgs.

“Seekyt—Juicy Couture Ballet Flats-Are They Worth the Money?,” <http://seekyt.com/juicy-couture-ballet-flats-are-they-worth-the-money/>, 14 pgs., Jun. 3, 2011.

Pictures of Juicy Couture flats offered for sale in 2011, 3 pgs.

“Purse Flats,” <http://purseflats.wordpress.com>, depicting Purse Flats by Erica Wilson, 3 pgs., Jul. 12, 2012.

Pictures of Purse Flats by Erica Wilson offered for sale in 2011, 6 pgs.

“Splash Page” <http://web.archive.org/web/20100524004346/http://www.tieks.com/>, 4 pgs., May 24, 2010.

“Tieks—Comfortable, designer flats you can fit in your purse and wear all day, every day,” <http://web.archive.org/web/20110731151555/http://tieks.com>, 6 pgs., Jul. 31, 2011.

“Tieks by Gavrieli—Comfortable, designer flats you can fit in your purse and wear all day . . .,” <http://web.archive.org/web/20110202210649/http://www.tieks.com/>, 8 pgs., Feb. 2, 2011.

“Carolina M. M. Gonzalez > Tieks by Gavrieli,” http://m2.facebook.com/Tieks?v=timeline&filter=2&timecutoff=1406427986&page=17§ionLoadingID=m_timeline_loading_div_1293868799_1262332800_8_17&timeend=1293868799×tart=1262332800&tm=AQDOvqhWQPN_Nbwm&refid=17, 1 pg. Jan. 26, 2010.

“The Shoes Oprah Would Wear to Work (if She Had to Walk),” <http://www.inc.com/30under30/christina-desmarais/kfir-gavrieli-and-elram-gavrieli-founders-of-tieks.html>, 8 pgs., Jul. 2, 2012.

“Tieks by Gavrieli,” http://m2.facebook.com/Tieks?v=timeline&filter=2&timecutoff=1406427986&page=14§ionLoadingID=m_timeline_loading_div_1293868799_1262332800_8_14&timeend=1293868799×tart=1262332800&tm=AQDOvqhWQPN_Nbwm&refid=17, 4 pgs., Jan. 26, 2010.

“Mighty Life List, Sensible Shoes,” <http://mightygirl.com/2010/08/24/sensible-shoes/>, 10 pgs., Aug. 24, 2010.

“Find! Tieks: Fab & sexy flats for fall,” <http://thefabmon.com/2013/08/29/find-tieks-fab-sexy-flats-for-fall/>, 3 pgs. Aug. 29, 2013.

“Step into Tieks,” <http://sliceofpink.typepad.com/blog/2010/09/tieks-1.html>, 5 pgs., Sep. 22, 2010.

“In Need of Flat-Soled Shoes,” <http://sliceofpink.typepad.com/blog/2010/09/tieks-1.html>, 7 pgs., Oct. 2010.

* cited by examiner

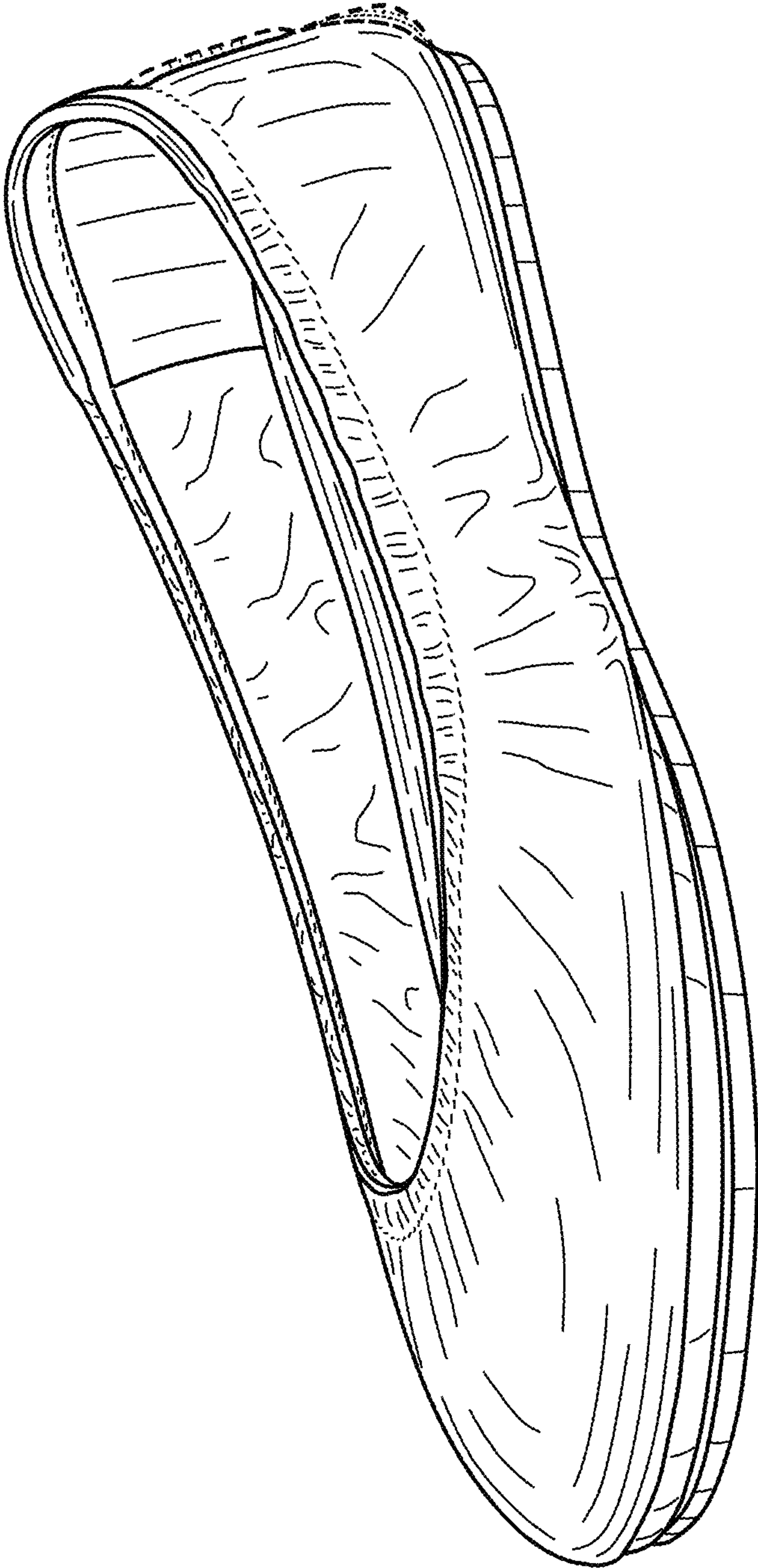

FIG. 1

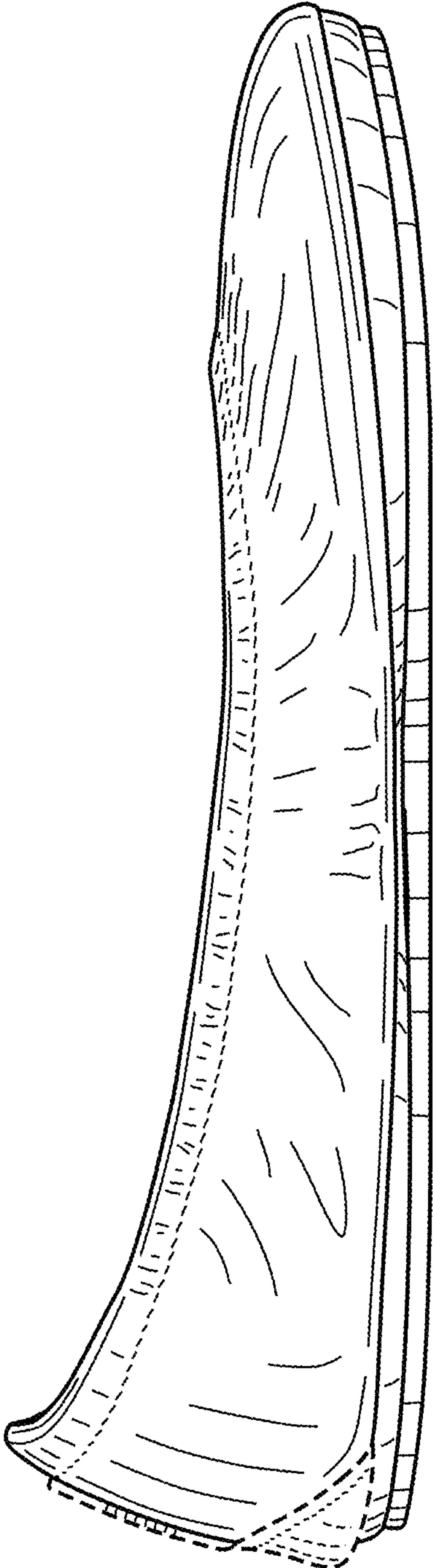

FIG. 2

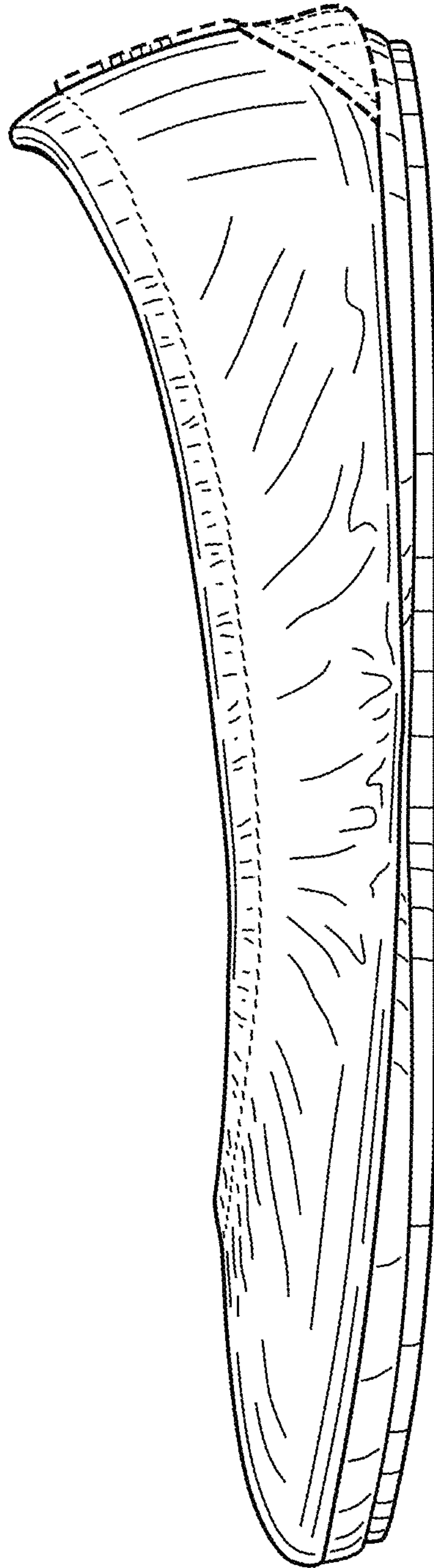

FIG. 3

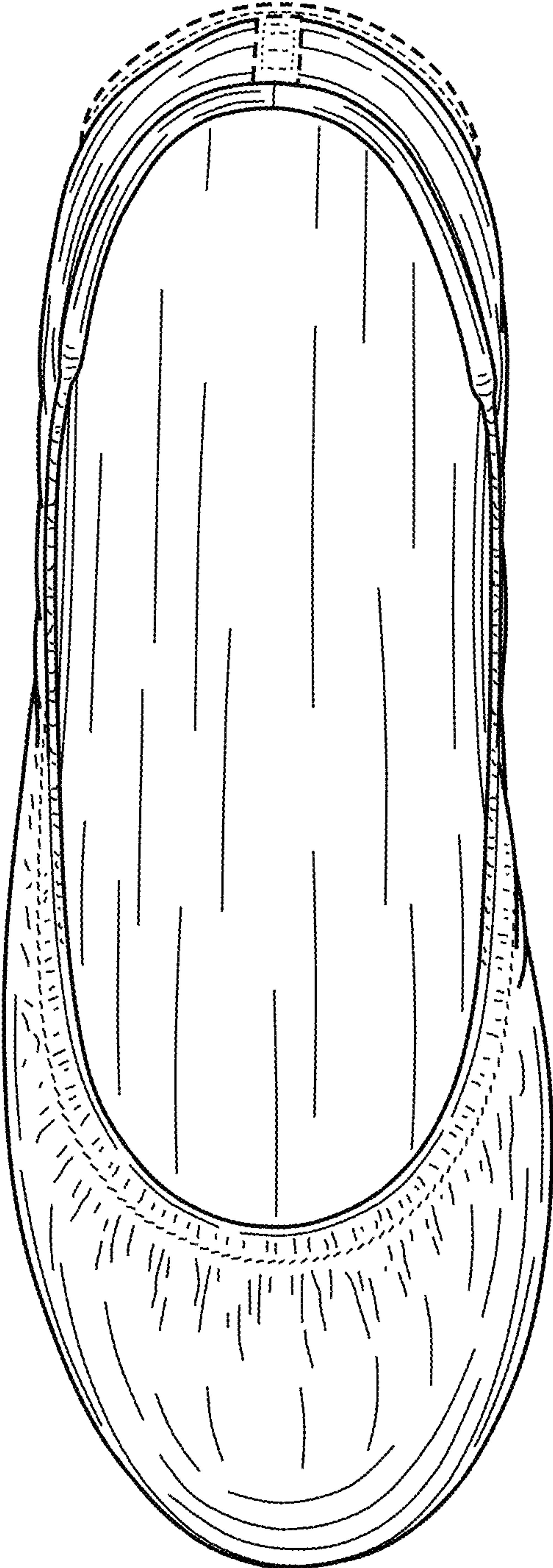

FIG. 4

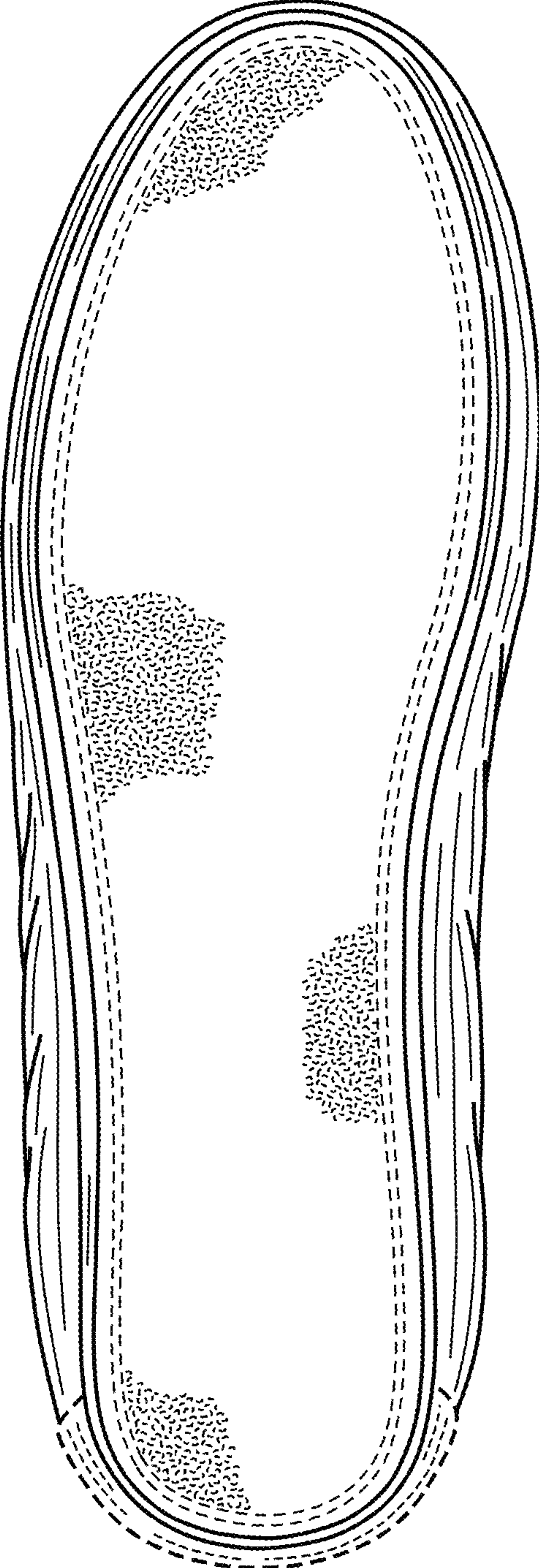

FIG. 5

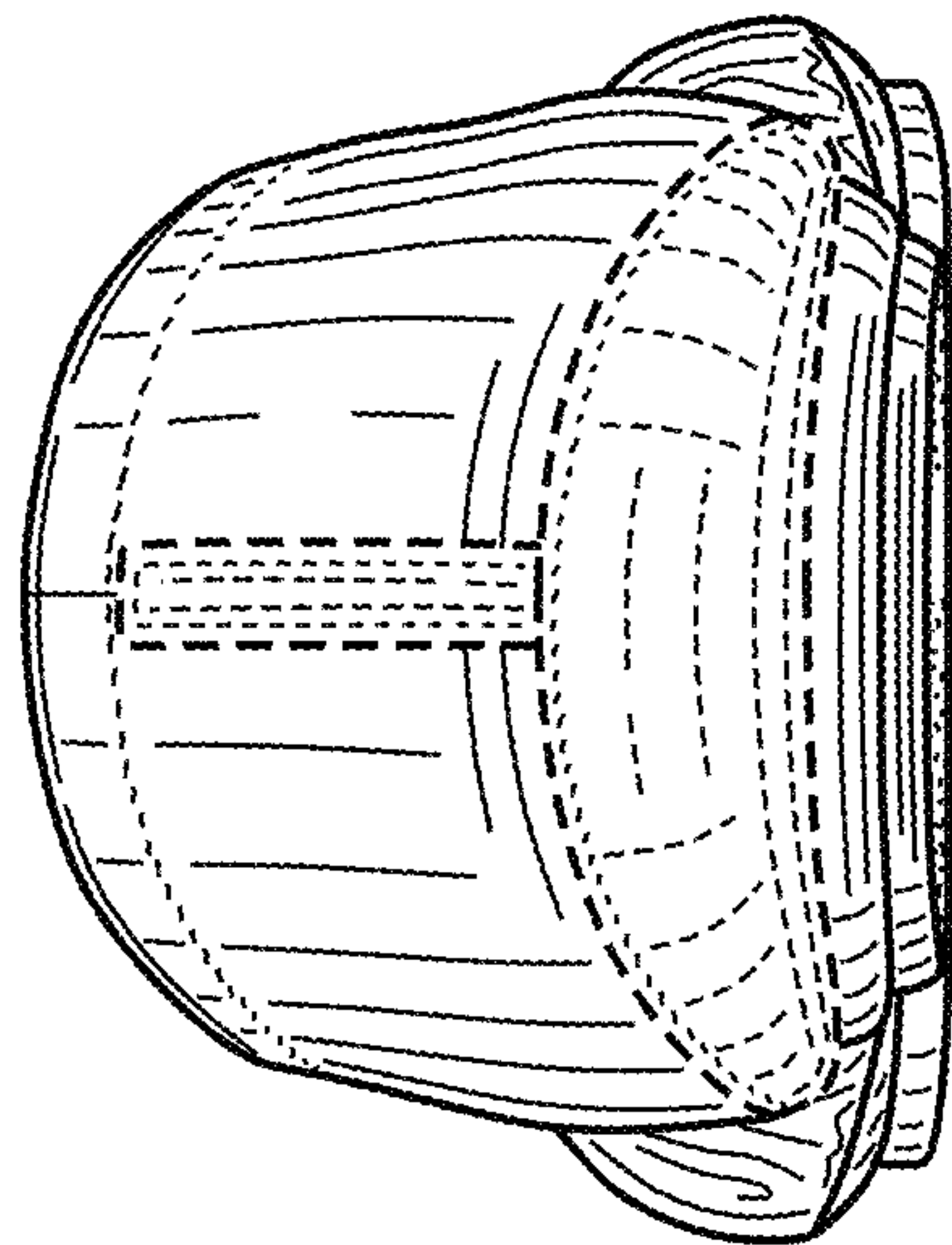

FIG. 7

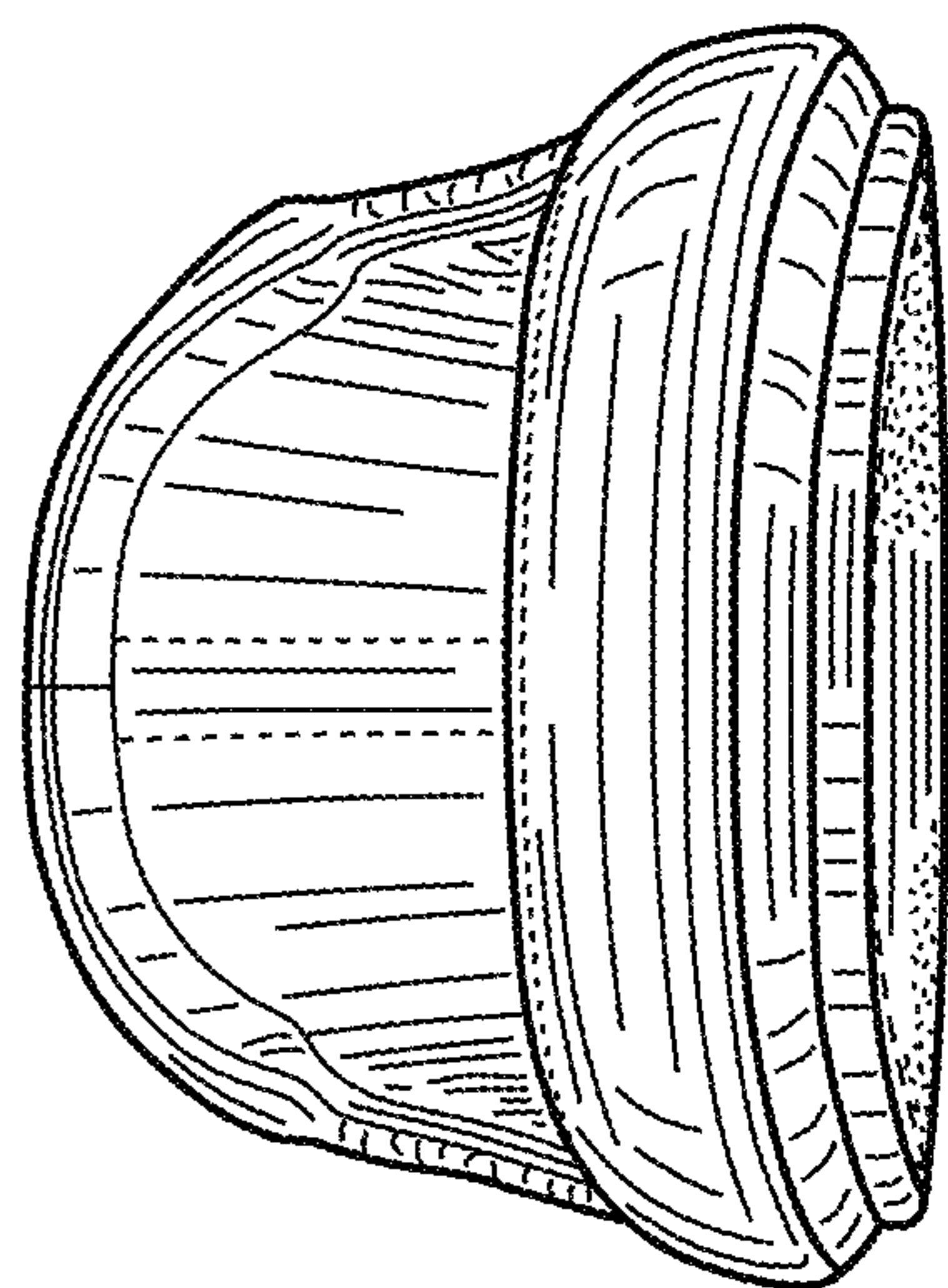

FIG. 6