



US00D761525S

(12) **United States Design Patent**  
**Mariosov**

(10) **Patent No.:** **US D761,525 S**  
(45) **Date of Patent:** **\*\* Jul. 19, 2016**

(54) **HAT WITH A NOVELTY FEATURE**

(71) Applicant: **Alexander Mariosov**, Las Vegas, NV  
(US)

(72) Inventor: **Alexander Mariosov**, Las Vegas, NV  
(US)

(\*\*) Term: **14 Years**

(21) Appl. No.: **29/485,868**

(22) Filed: **Mar. 24, 2014**

(51) **LOC (10) CI.** ..... **02-03**

(52) **U.S. CI.**

USPC ..... **D2/882**

(58) **Field of Classification Search**

USPC ..... D2/865, 866, 878, 879, 880, 881, 882,  
D2/883, 884, 886, 888, 891, 893, 894,  
D2/895; D24/110.3, 110.4; 2/171, 183,  
2/175.1, 175.3, 175.7, 195.1, 195.2,  
2/195.3, 195.4, 195.7, 200.1, 209.11,  
2/209.12, 209.13, 209.3, 209.4, 209.7;  
128/207.11

CPC ..... A42B 1/006; A42B 1/02  
See application file for complete search history.

(56) **References Cited**

**U.S. PATENT DOCUMENTS**

D160,404 S \* 10/1950 Levine ..... D2/866  
4,985,935 A \* 1/1991 Hur ..... 446/27

D336,969 S \* 7/1993 Mullendore et al. .... D2/866  
5,359,733 A \* 11/1994 Brannon et al. .... 2/195.1  
5,437,062 A \* 8/1995 Douglas ..... 2/195.1  
5,465,426 A \* 11/1995 Beaton ..... 2/195.1  
5,581,813 A \* 12/1996 Henschel ..... 2/195.1  
D442,355 S \* 5/2001 Rose ..... D2/882  
8,234,721 B1 \* 8/2012 Cestare et al. .... 2/171.1  
D671,716 S \* 12/2012 Lam et al. .... D2/882  
2002/0095715 A1 \* 7/2002 Hong ..... 2/209.11  
2003/0233696 A1 \* 12/2003 Lee ..... 2/195.2  
2004/0187191 A1 \* 9/2004 Lee ..... 2/171  
2011/0219508 A1 \* 9/2011 Hill ..... 2/10  
2011/0314580 A1 \* 12/2011 Vach ..... 2/10

\* cited by examiner

*Primary Examiner* — Karen E Eldridge Powers

(57) **CLAIM**

The ornamental design for a hat with a novelty feature, as shown and described.

**DESCRIPTION**

FIG. 1 is a front elevation view thereof;  
FIG. 2 is a rear elevation view thereof;  
FIG. 3 is a left side elevation view thereof;  
FIG. 4 is a top plan view thereof;  
FIG. 5 is a bottom plan view thereof; and,  
FIG. 6 is a perspective view thereof.  
The broken lines shown in the drawings illustrate portions of the article of manufacture that form no part of the claimed design.

**1 Claim, 6 Drawing Sheets**

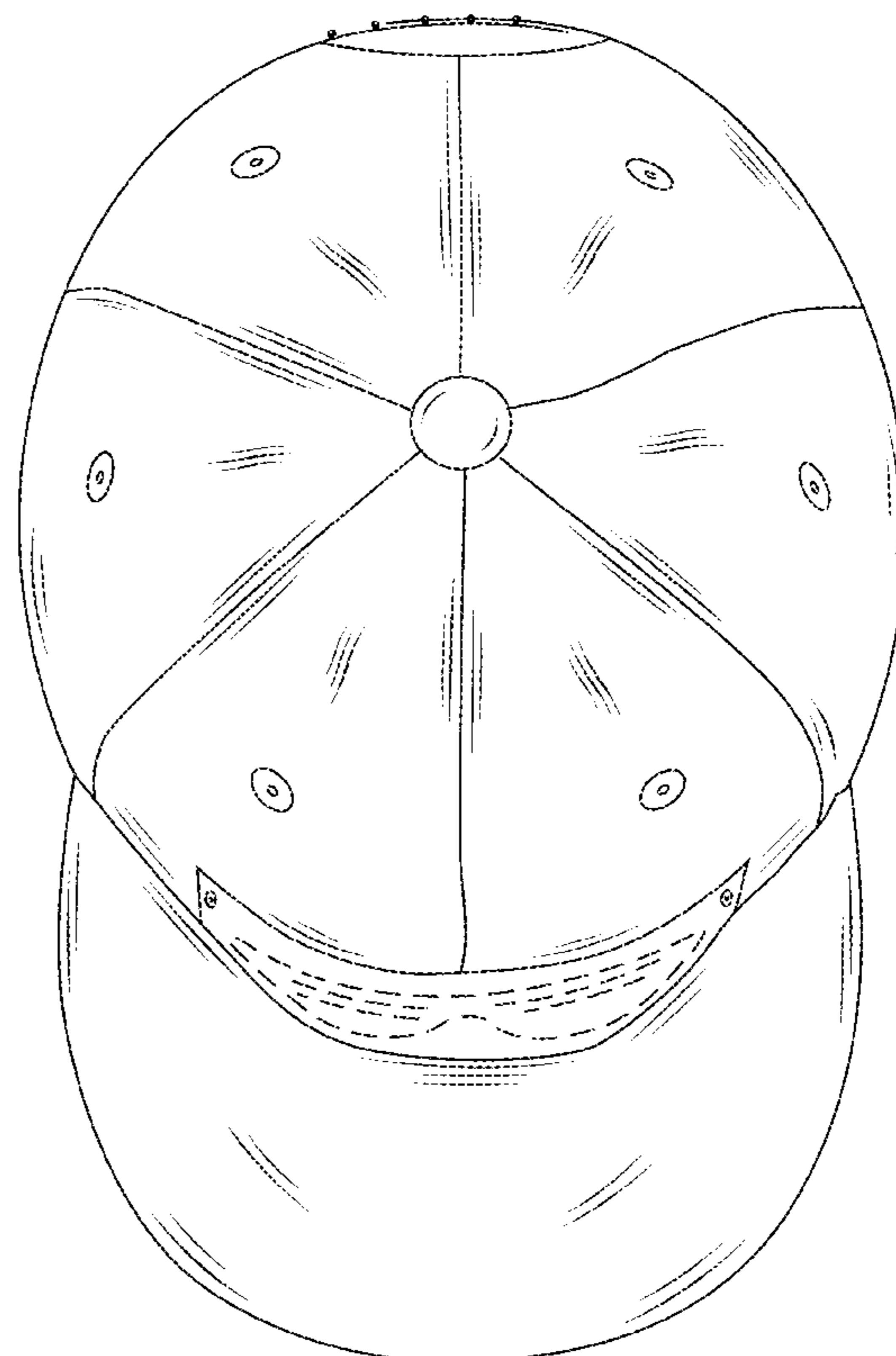
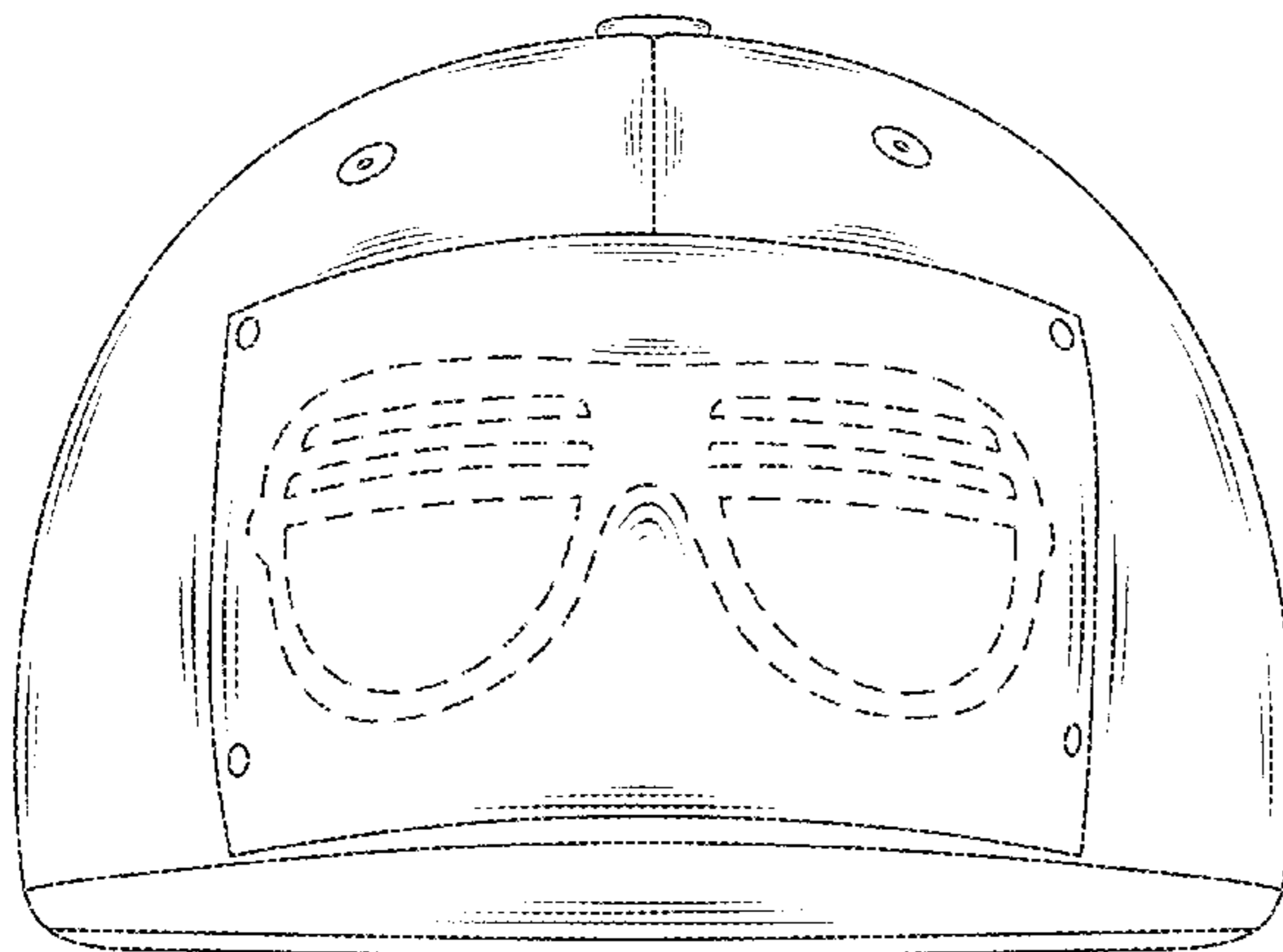

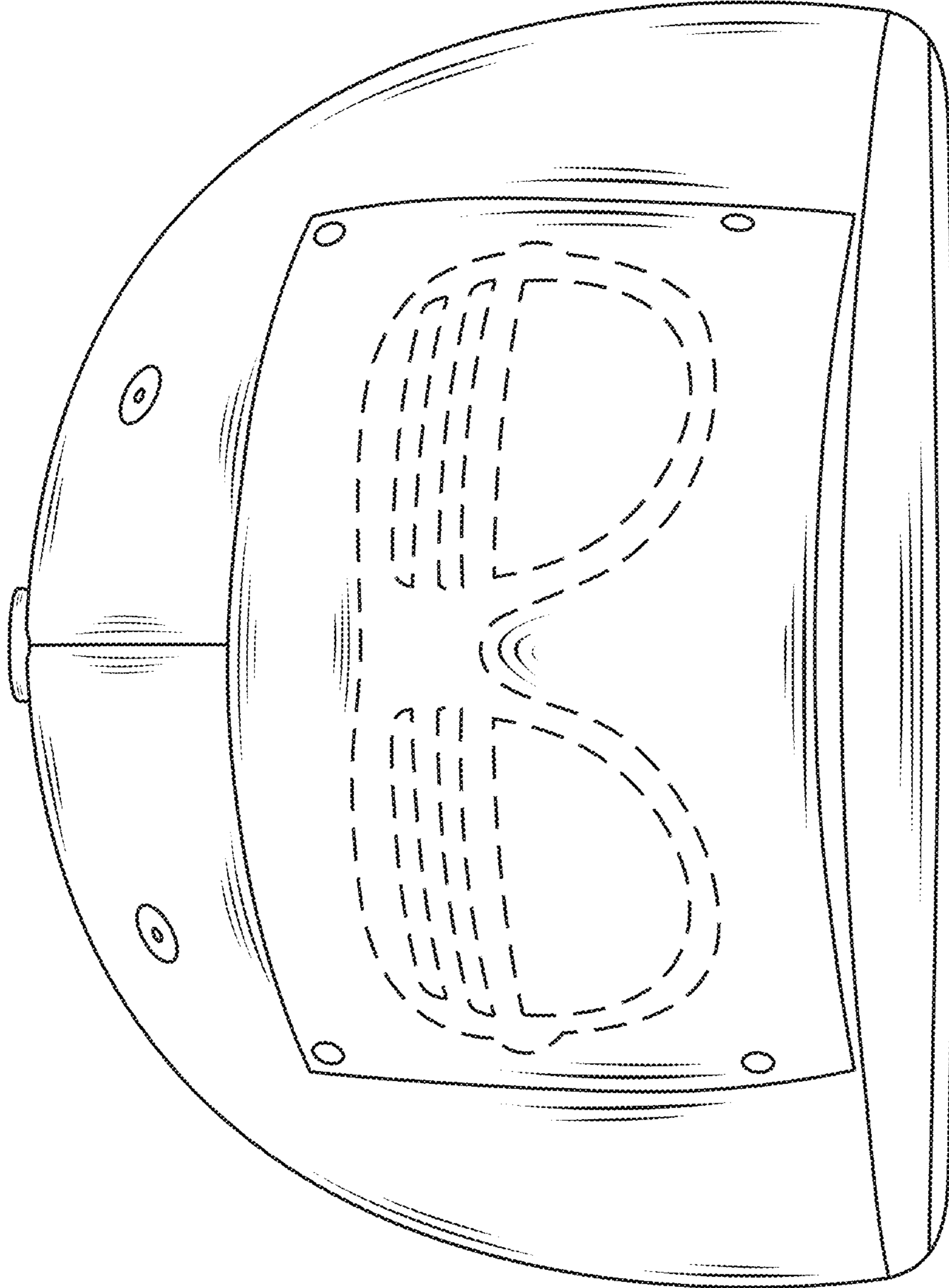

FIG. 1

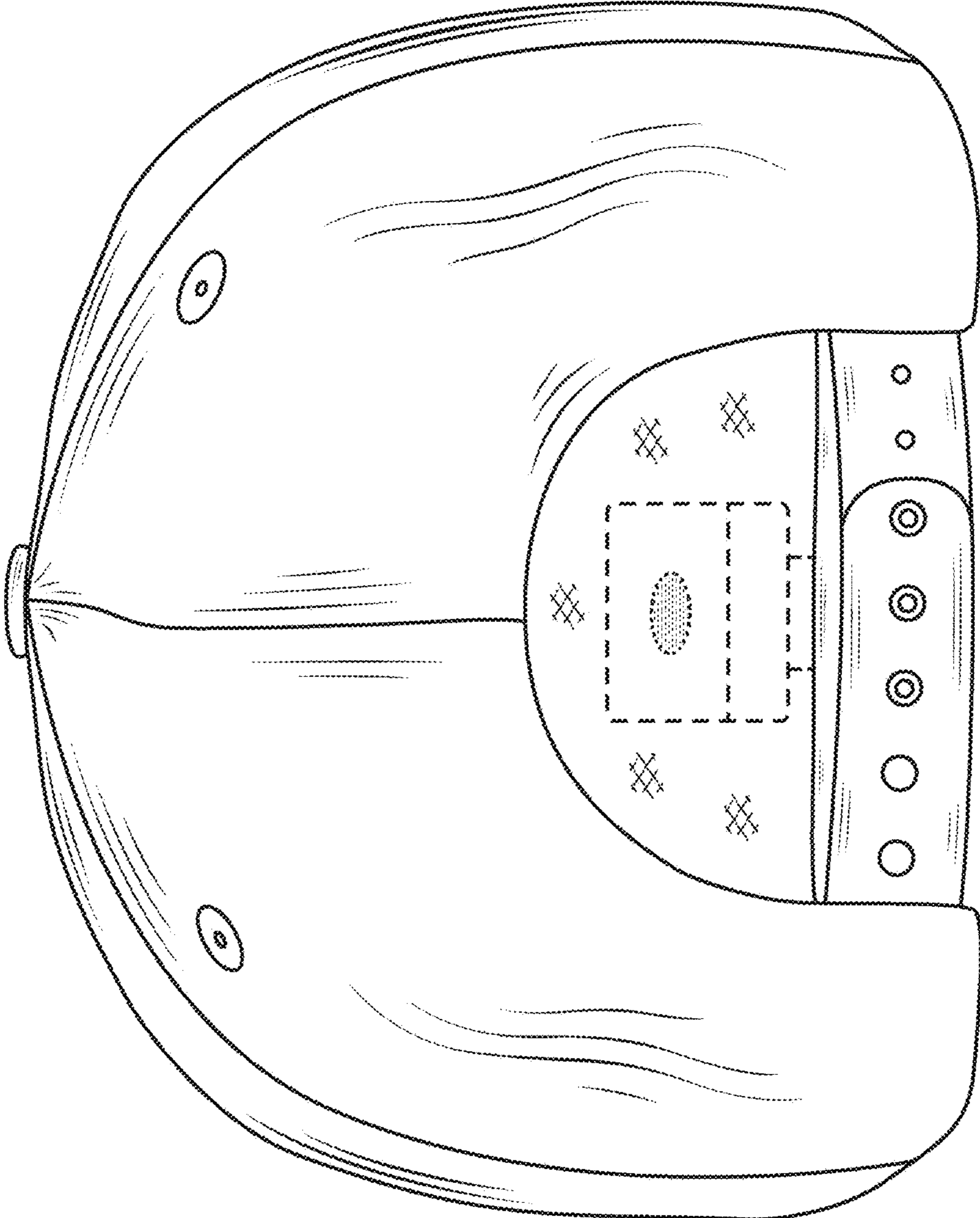

FIG. 2

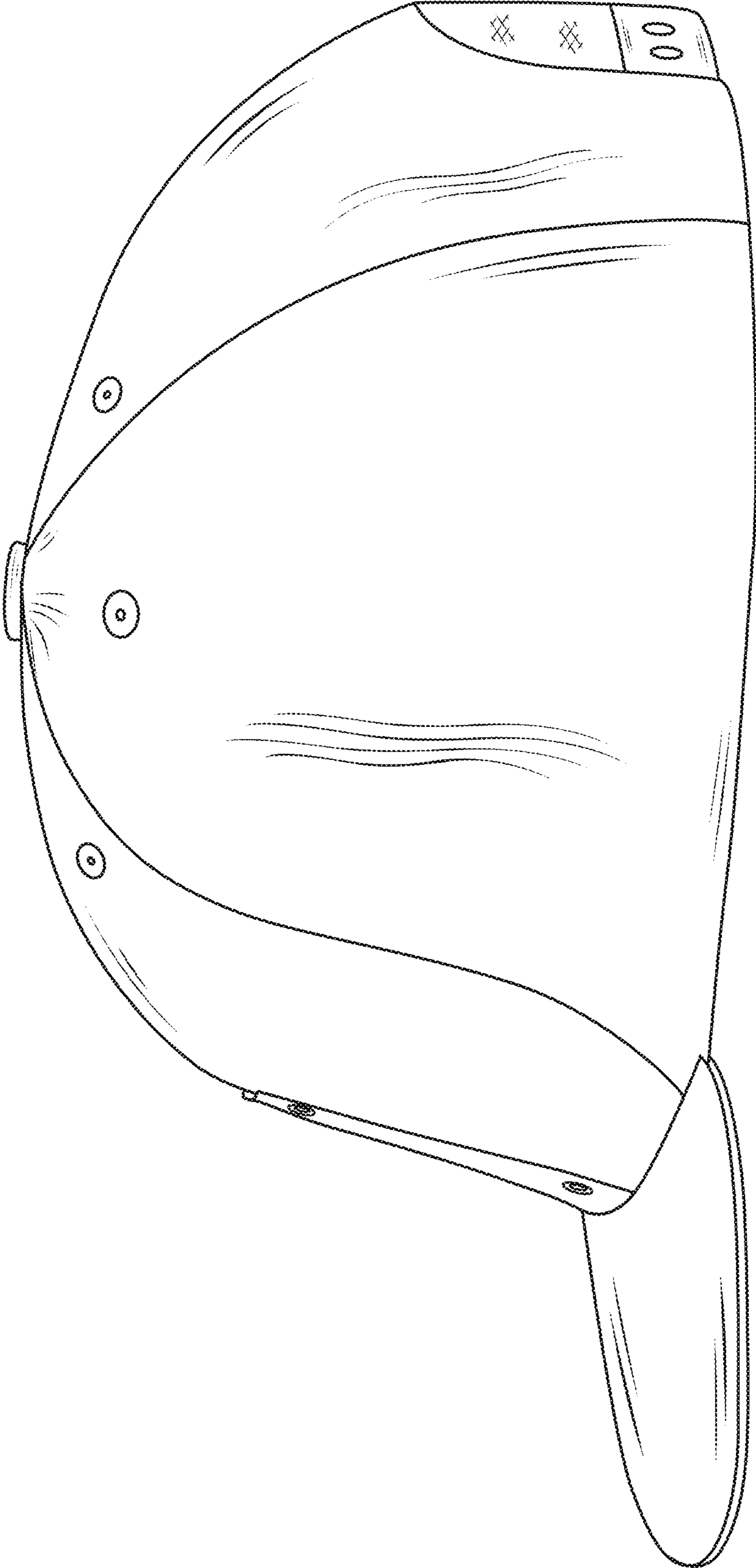

FIG. 3

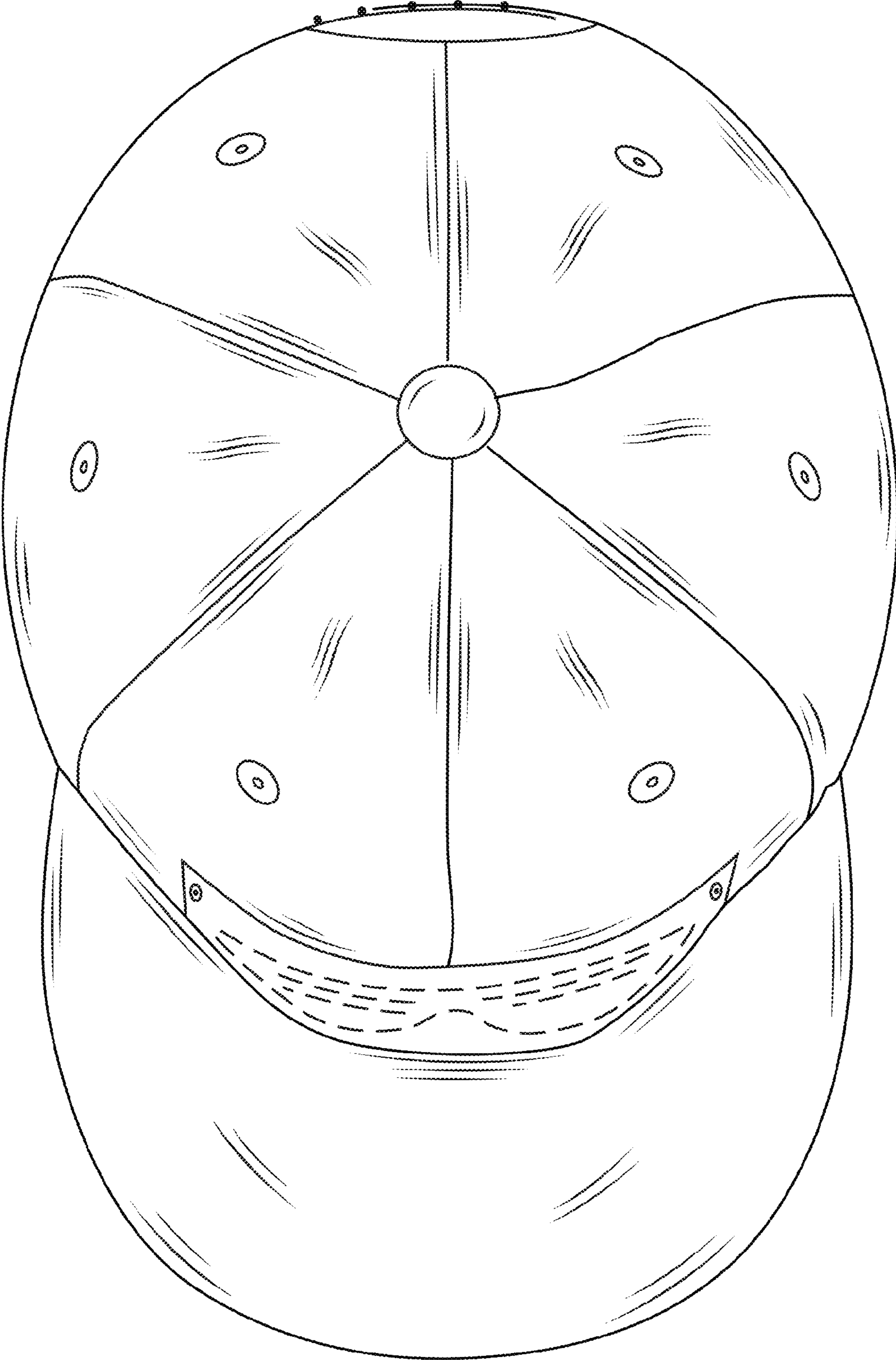

FIG. 4

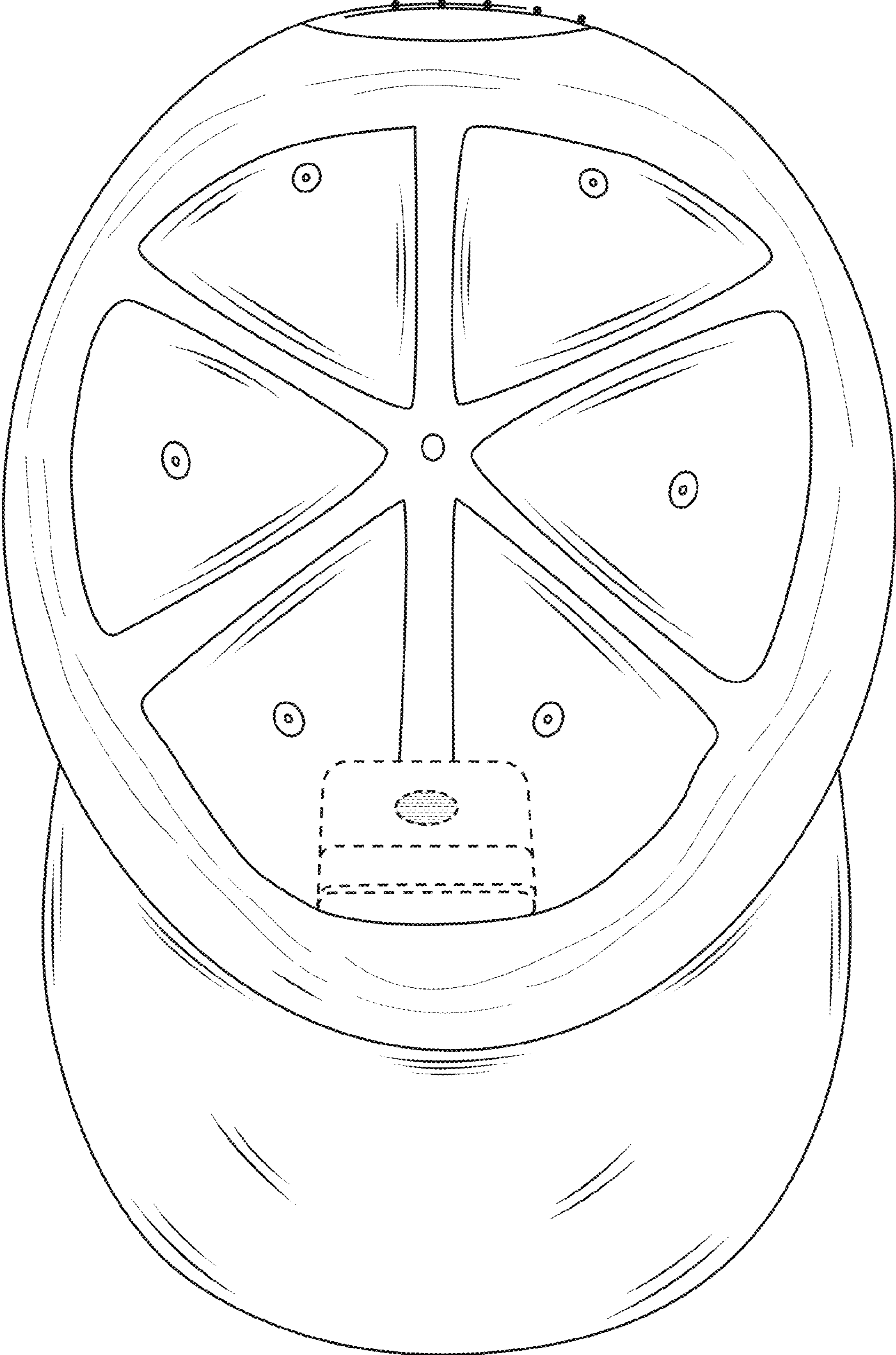

FIG. 5

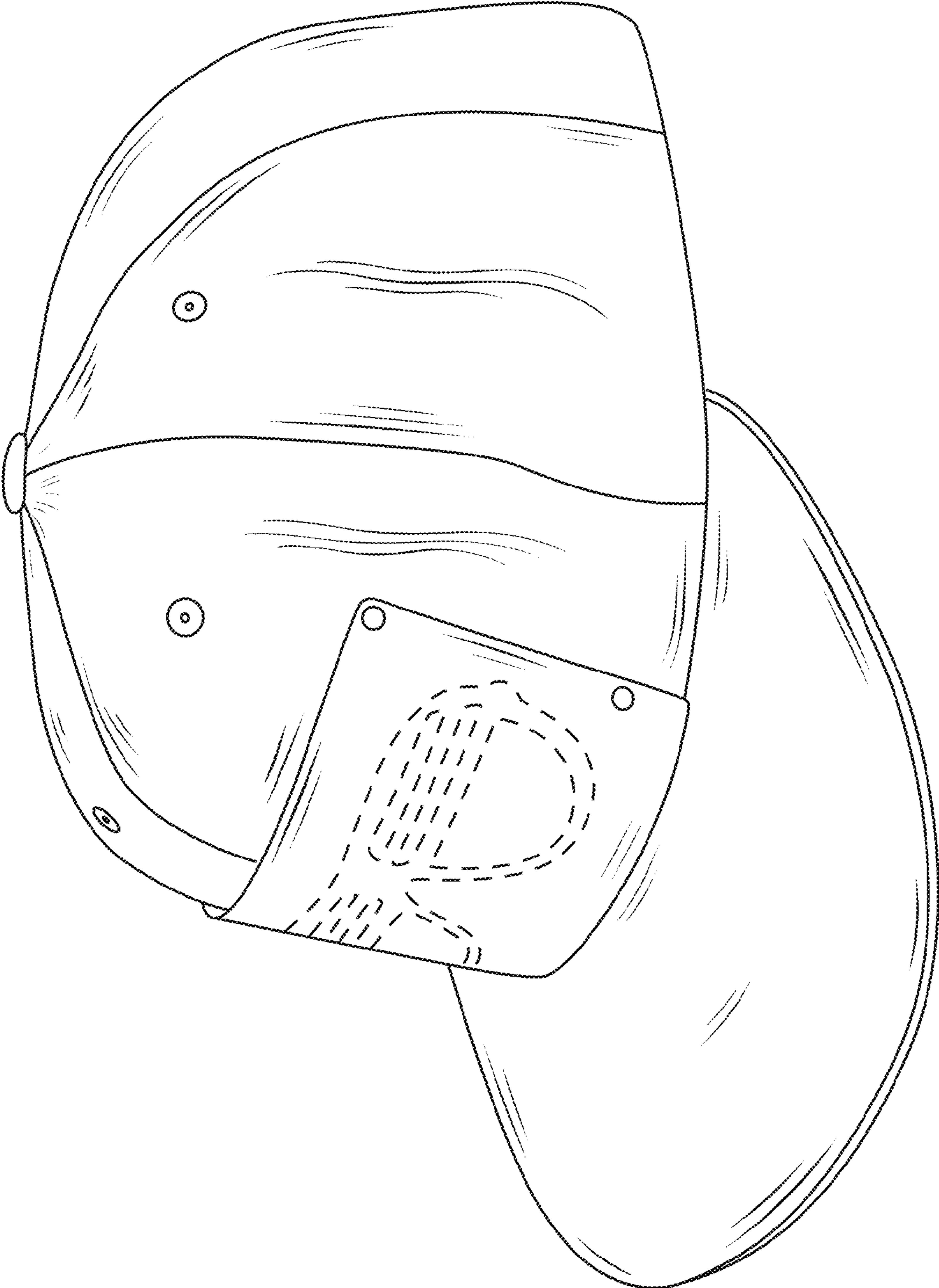

FIG. 6