



US00D761465S

(12) **United States Design Patent**  
**Sugesawa et al.**

(10) **Patent No.:** **US D761,465 S**  
(45) **Date of Patent:** **\*\* Jul. 12, 2016**

(54) **LIGHT BAR FOR A MOTOR VEHICLE**

(56) **References Cited**

(71) Applicants: **CENTRAL JAPAN RAILWAY COMPANY**, Nagoya-shi, Aichi (JP);  
**NIPPON SHARYO, LTD.**, Nagoya-shi, Aichi (JP)

U.S. PATENT DOCUMENTS

D526,430 S \* 8/2006 Hernandez ..... D26/31  
D576,754 S \* 9/2008 Wang ..... D26/31  
D653,783 S \* 2/2012 Biro ..... D26/31

(72) Inventors: **Masahiro Sugesawa**, Nagoya (JP);  
**Tomoyuki Fukunaga**, Nagoya (JP);  
**Yoshikazu Sumi**, Motosu (JP);  
**Masayuki Hattori**, Motosu (JP);  
**Kuniharu Matsuda**, Osaka (JP); **Akira Nishikawa**, Osaka (JP); **Hiroki Tanaka**, Nagoya (JP); **Hiroyuki Ishikura**, Nagoya (JP)

*Primary Examiner* — Marcus Jackson  
(74) *Attorney, Agent, or Firm* — Oliff PLC

(73) Assignees: **NIPPON SHARYO, LTD.**, Nagoya (JP); **CENTRAL JAPAN RAILWAY COMPANY**, Nagoya (JP)

(57) **CLAIM**  
The ornamental design for a light bar for a motor vehicle, as shown and described.

(\*\*) Term: **14 Years**

**DESCRIPTION**

(21) Appl. No.: **29/521,009**

(22) Filed: **Mar. 19, 2015**

(30) **Foreign Application Priority Data**

Sep. 19, 2014 (JP) ..... 2014-020847  
Sep. 19, 2014 (JP) ..... 2014-020848  
Sep. 19, 2014 (JP) ..... 2014-020849  
Sep. 19, 2014 (JP) ..... 2014-020852  
Sep. 19, 2014 (JP) ..... 2014-020853  
Sep. 19, 2014 (JP) ..... 2014-020854  
Sep. 19, 2014 (JP) ..... 2014-020855

FIG. 1 is a front elevational view of the light bar for a motor vehicle, with the center portions broken away to indicate indeterminate length;  
FIG. 2 is a rear elevational view thereof;  
FIG. 3 is a right elevational view thereof;  
FIG. 4 is a left elevational view thereof;  
FIG. 5 is a top plan view thereof;  
FIG. 6 is a bottom plan view thereof;  
FIG. 7 is an enlarged view of the area 7 in FIG. 1;  
FIG. 8 is an enlarged view of the area 8 in FIG. 1;  
FIG. 9 is an enlarged view of the area 9 in FIG. 1;  
FIG. 10 is an enlarged view of the area 10 in FIG. 2;  
FIG. 11 is an enlarged view of the area 11 in FIG. 2;  
FIG. 12 is an enlarged view of the area 12 in FIG. 5;  
FIG. 13 is a cross-sectional view along line 13 in FIG. 7;  
FIG. 14 is a cross-sectional view along line 14 in FIG. 9; and,  
FIG. 15 is a cross-sectional view along line 15 in FIG. 7.  
The broken lines depict environmental subject matter only and form no part of the claimed design. The dot-dot-dash chain lines indicate enlargement areas and form no part of the claimed design. The appearance of the portion of the article between the bracketed break forms no part of the claimed design.

(51) **LOC (10) Cl.** ..... **26-06**

(52) **U.S. Cl.**  
USPC ..... **D26/28**

(58) **Field of Classification Search**  
USPC ..... D26/28-36; 362/61, 80-83, 267-269, 362/459-468, 475-478, 485-487  
CPC ..... F21S 48/00; F21S 48/10; F21S 48/115; F21S 48/225; F21S 48/1233; F21S 48/1266; F21S 48/1388; F21S 48/2268; F21V 21/04  
See application file for complete search history.

**1 Claim, 10 Drawing Sheets**

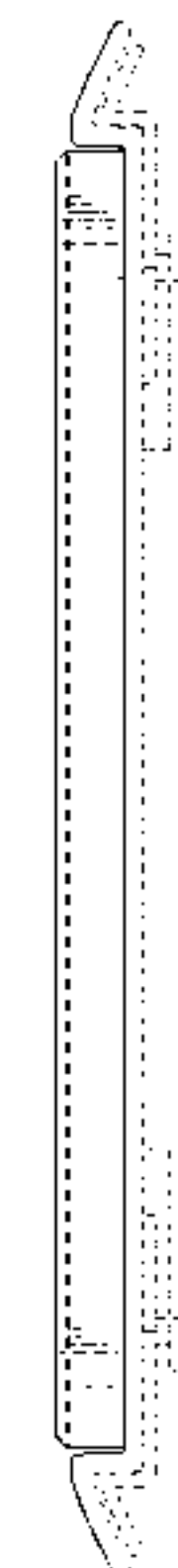
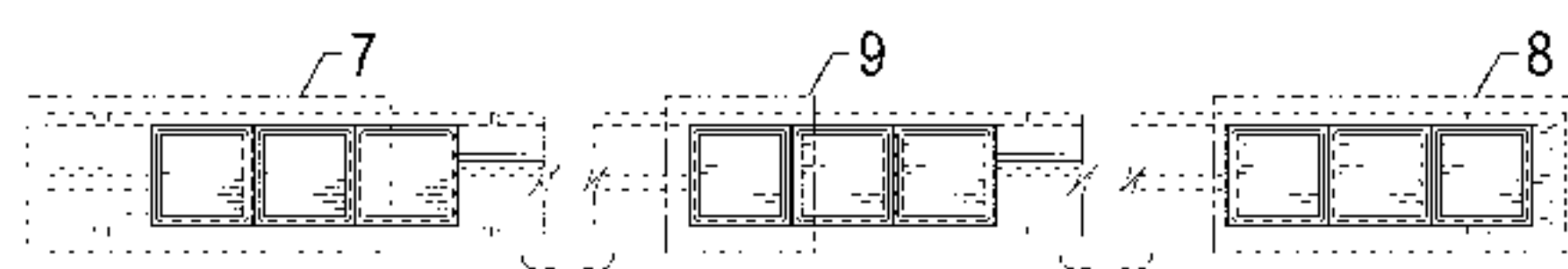

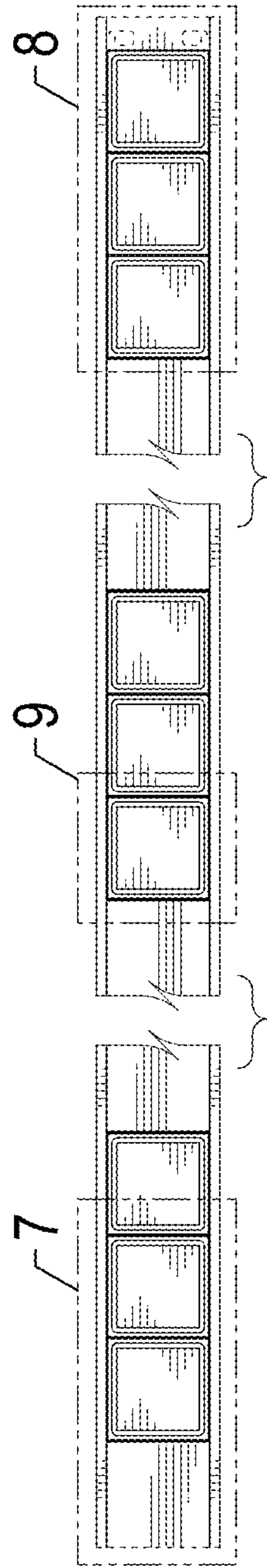

FIG. 1

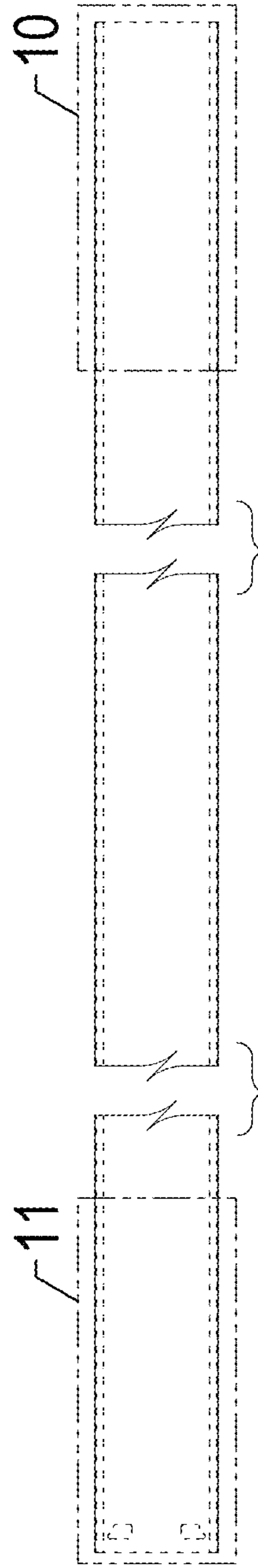

FIG. 2

FIG. 4

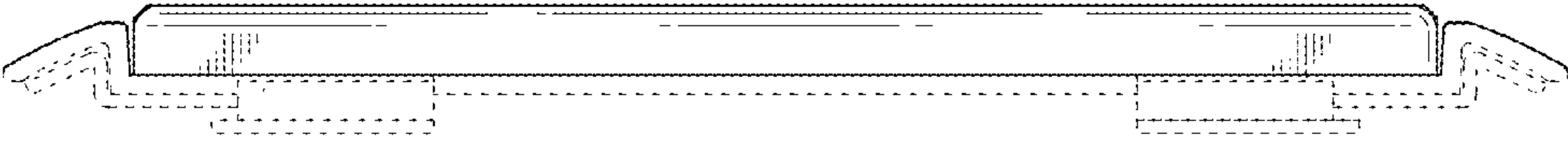
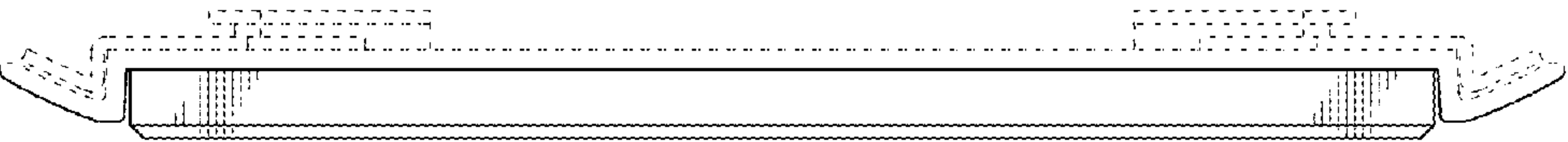

FIG. 3



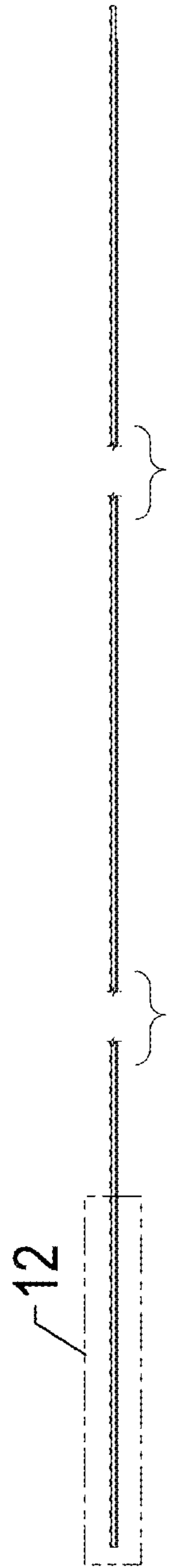

FIG. 5



FIG. 6

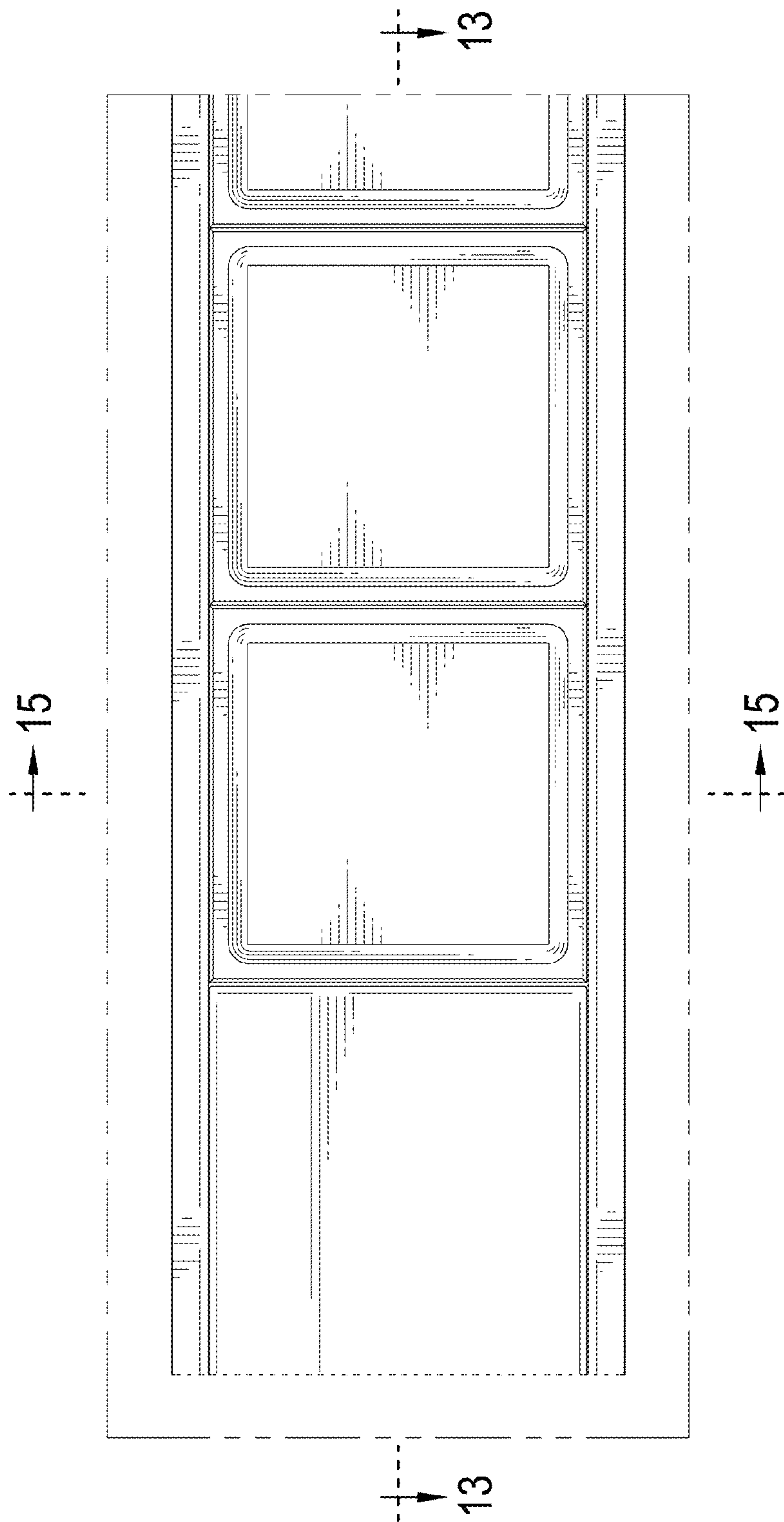

FIG. 7

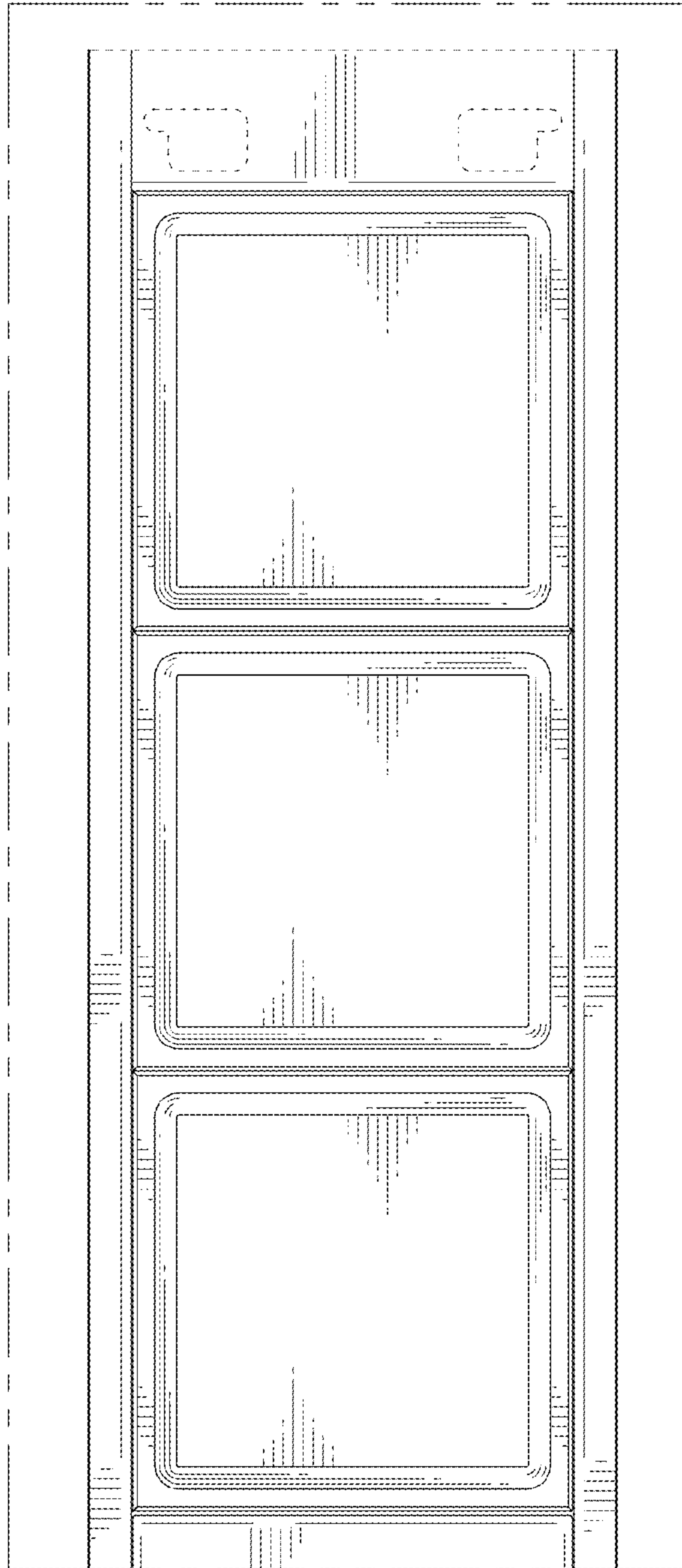

FIG. 8



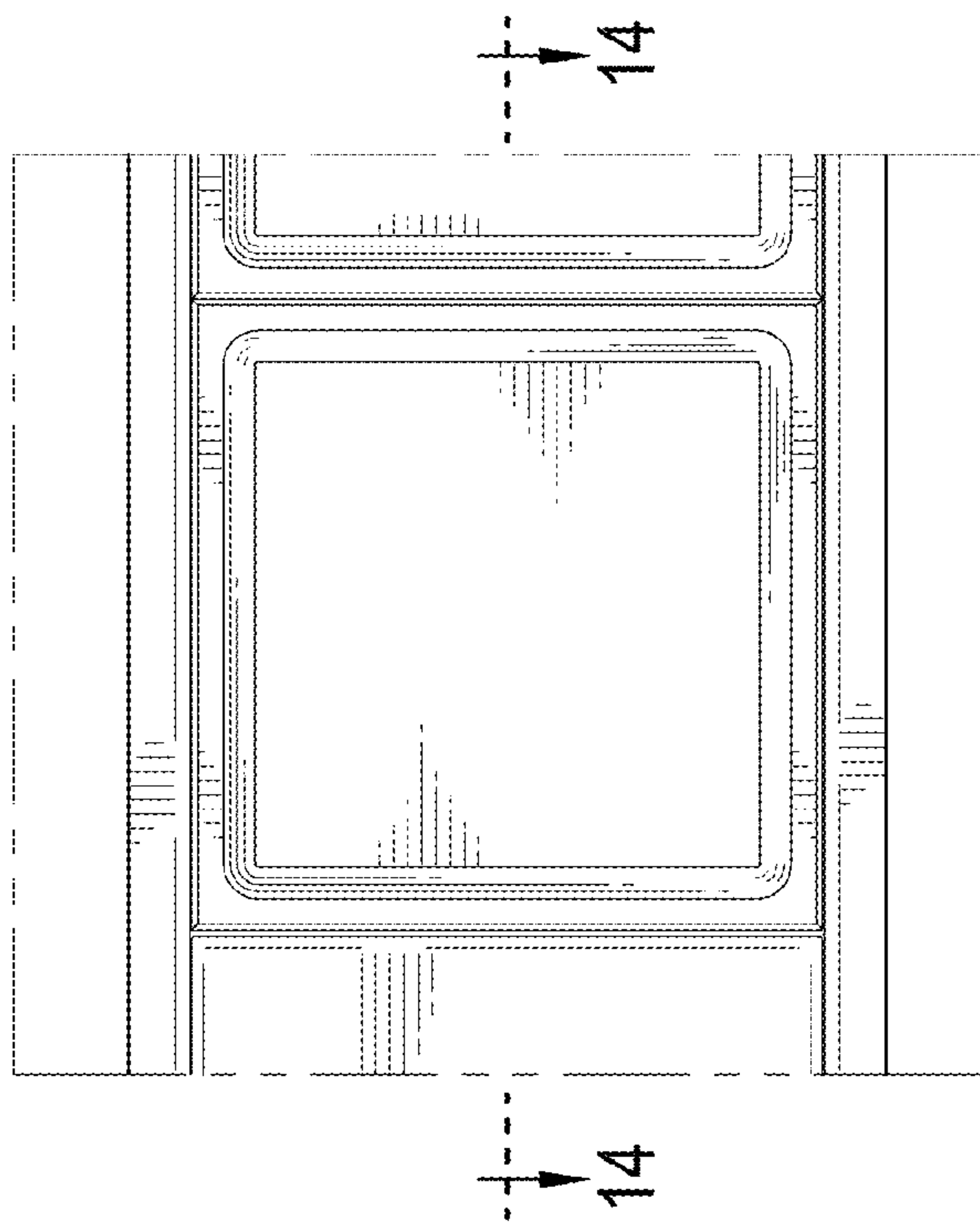

FIG. 9

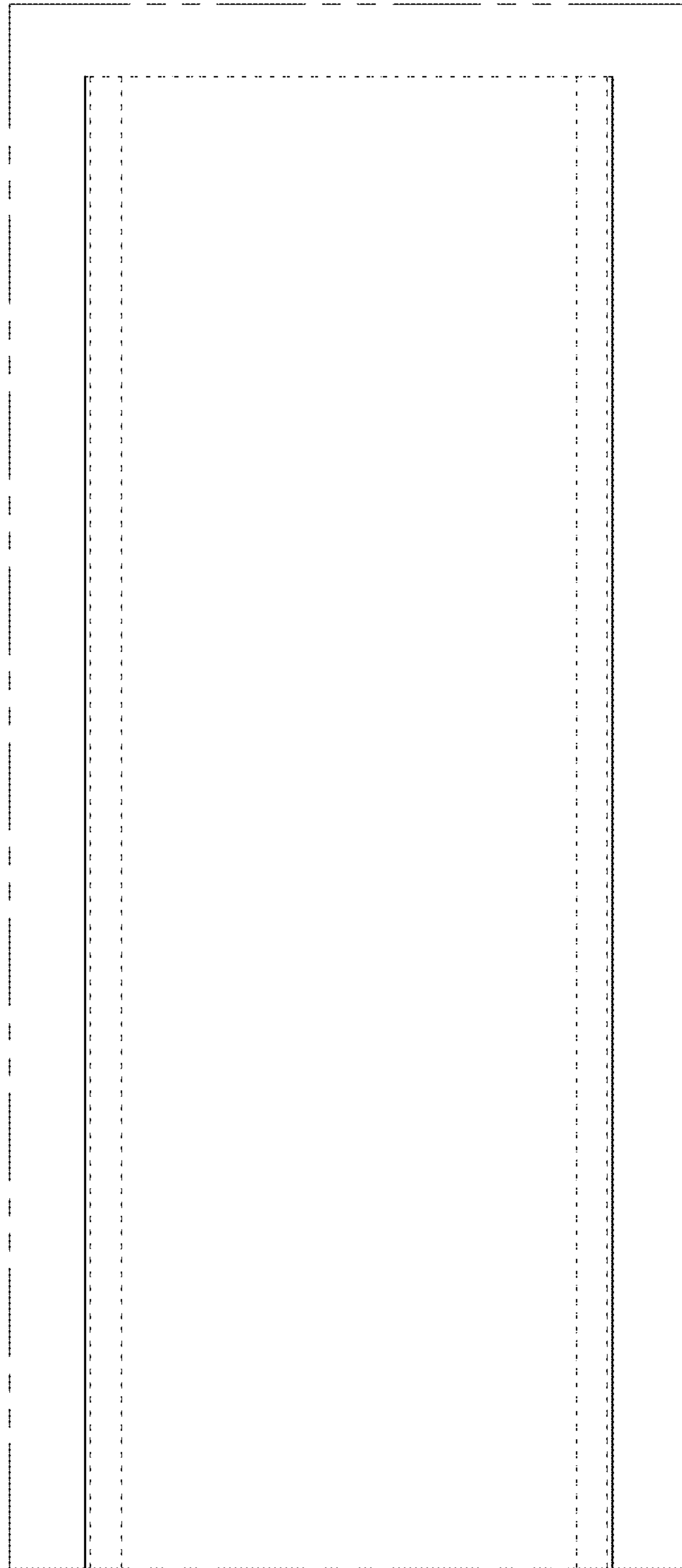

FIG. 10



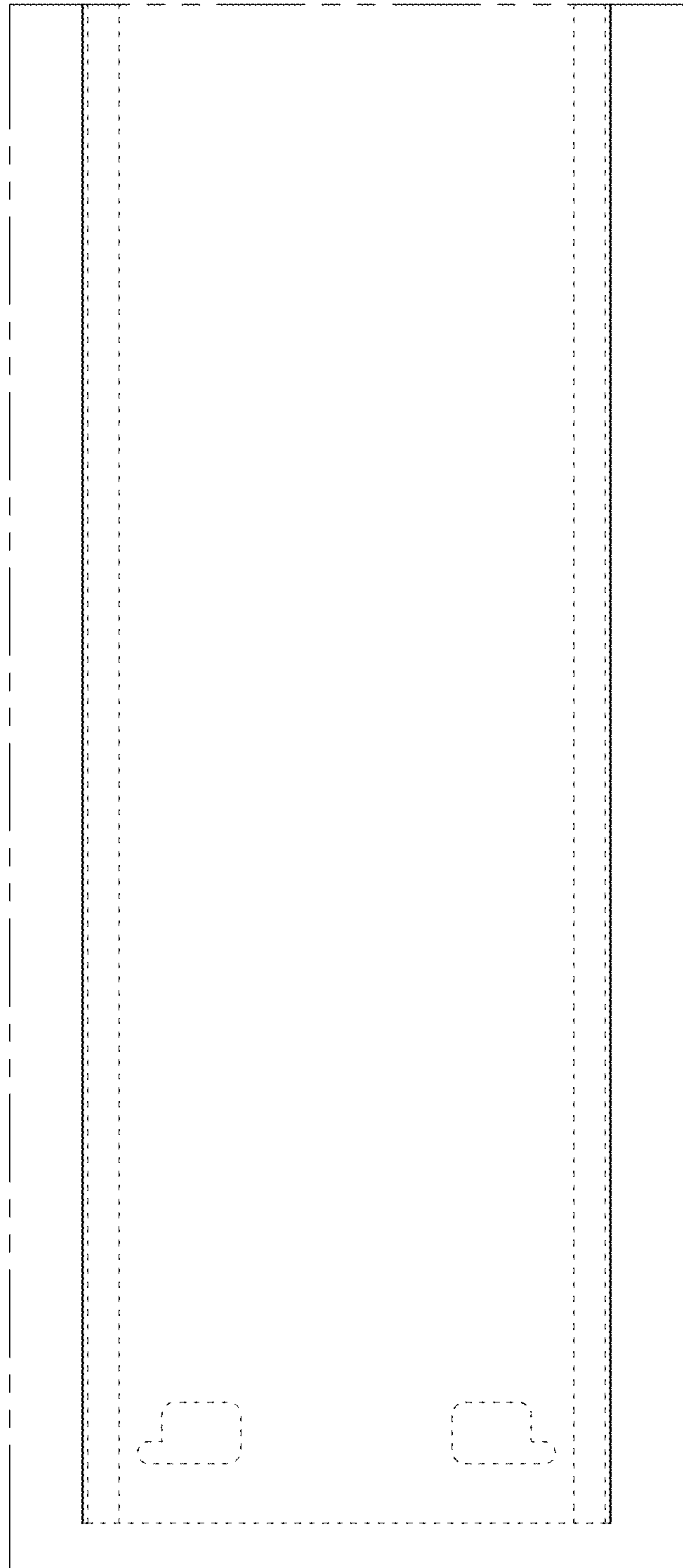

FIG. 11

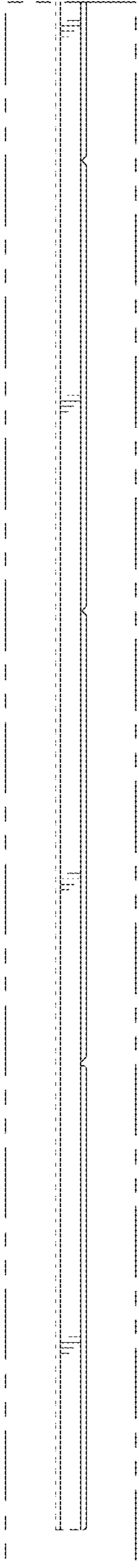

FIG. 12

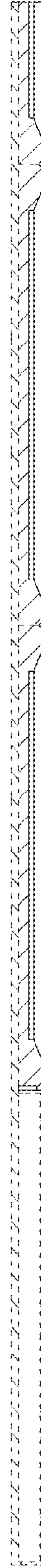

FIG. 13

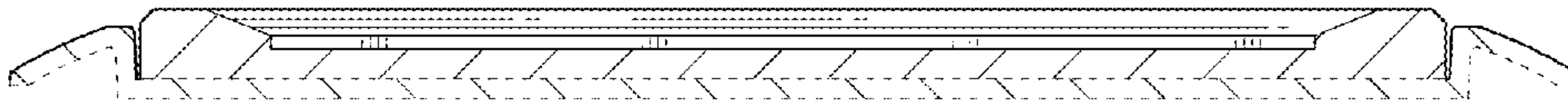

FIG. 15

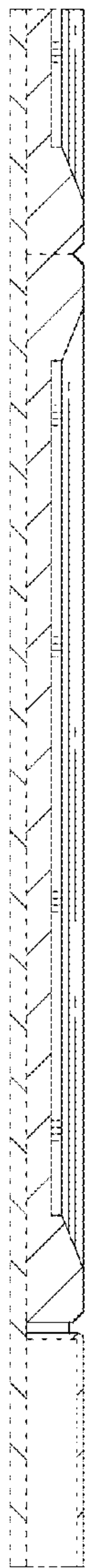

FIG. 14