



US00D761452S

(12) **United States Design Patent**  
Su

(10) **Patent No.:** US D761,452 S  
(45) **Date of Patent:** \*\* Jul. 12, 2016

(54) **PORTION OF A LED BULB**

(71) Applicants: **CAL-COMP ELECTRONICS & COMMUNICATIONS COMPANY LIMITED**, New Taipei (TW); **KINPO ELECTRONICS, INC.**, New Taipei (TW)

(72) Inventor: **Ching-Yu Su**, New Taipei (TW)

(73) Assignees: **CAL-COMP ELECTRONICS & COMMUNICATIONS COMPANY LIMITED**, New Taipei (TW); **KINPO ELECTRONICS, INC.**, New Taipei (TW)

(\*\*) Term: **15 Years**

(21) Appl. No.: **29/527,983**

(22) Filed: **May 22, 2015**

(51) **LOC (10) Cl.** ..... **26-04**

(52) **U.S. Cl.**  
USPC ..... **D26/2**

(58) **Field of Classification Search**  
USPC ..... D26/1-4; 313/313, 315, 316, 317, 318, 313/493; 315/52, 53, 56, 57, 58  
CPC ..... H01J 5/48; H01J 5/50; H01J 19/54; F21V 5/00; F21K 9/13; F21K 9/135; F21K 9/1375

See application file for complete search history.

(56) **References Cited**

U.S. PATENT DOCUMENTS

D656,252 S *	3/2012	Engl	.....	D26/2
D679,035 S *	3/2013	Le	.....	D26/2
D696,437 S *	12/2013	Webb	.....	D26/2

\* cited by examiner

*Primary Examiner* — Marcus Jackson

(74) *Attorney, Agent, or Firm* — Chun-Ming Shih; HDLS IPR Services

(57) **CLAIM**

The ornamental design for a portion of a LED bulb, as shown and described.

**DESCRIPTION**

FIG. 1 is a perspective view of a portion of a LED bulb showing my new design;  
FIG. 2 is a front view thereof;  
FIG. 3 is a rear view thereof;  
FIG. 4 is a left side view thereof;  
FIG. 5 is a right side view thereof;  
FIG. 6 is a top view thereof;  
FIG. 7 is a bottom view thereof; and,  
FIG. 8 is second perspective view showing the portion of a LED bulb.

The broken lines shown represent unclaimed subject matter and form no part of the claimed design.

**1 Claim, 8 Drawing Sheets**

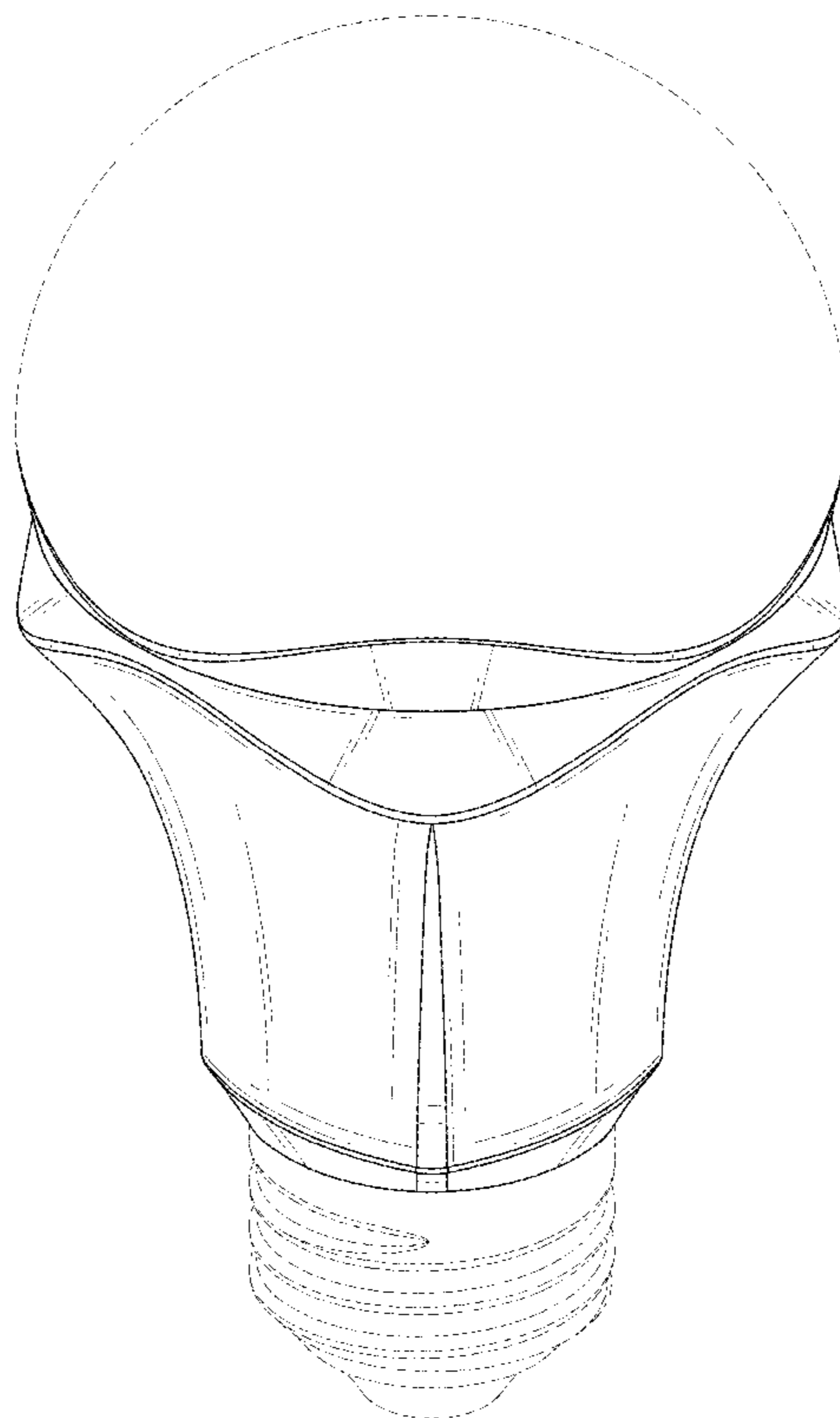

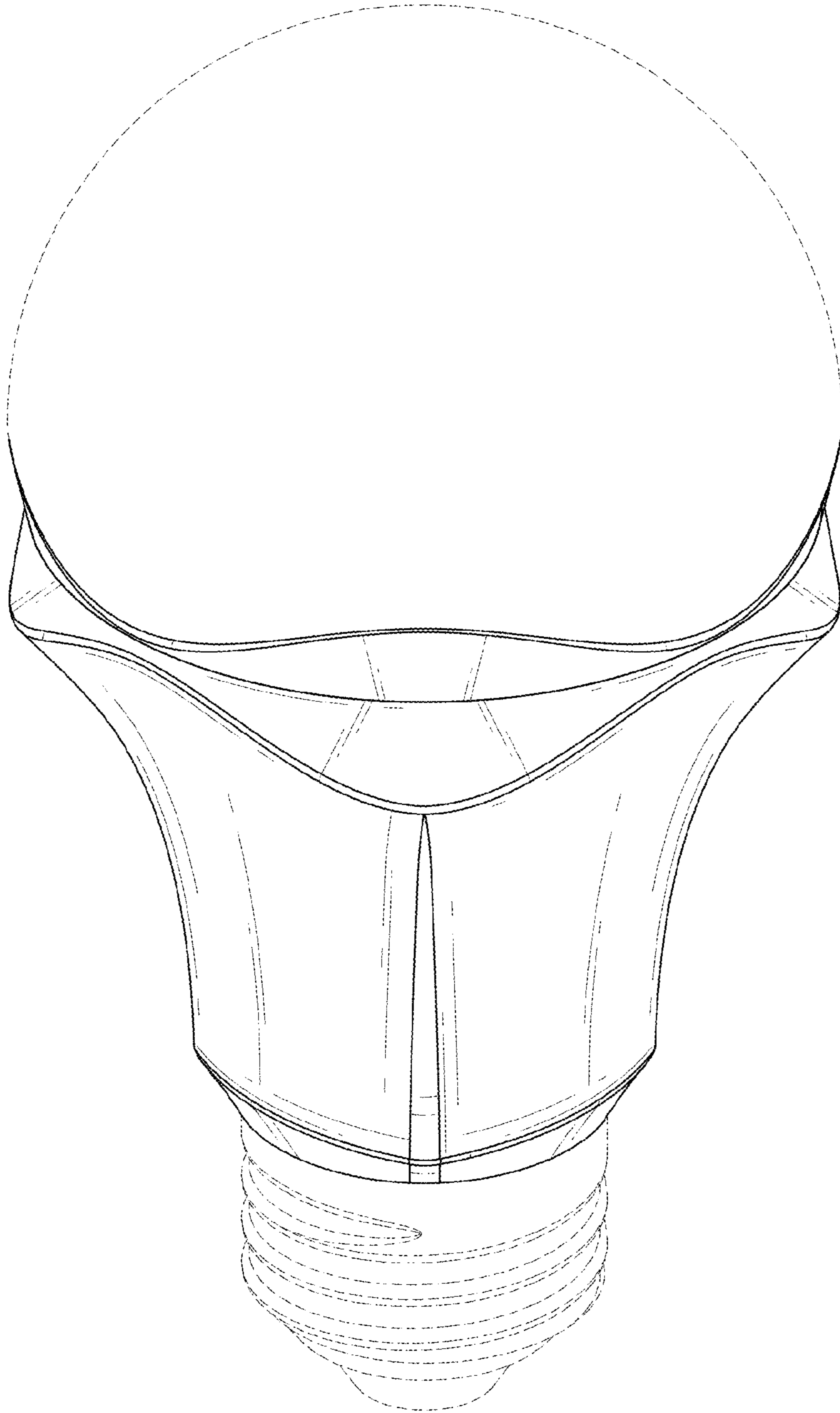

FIG. 1

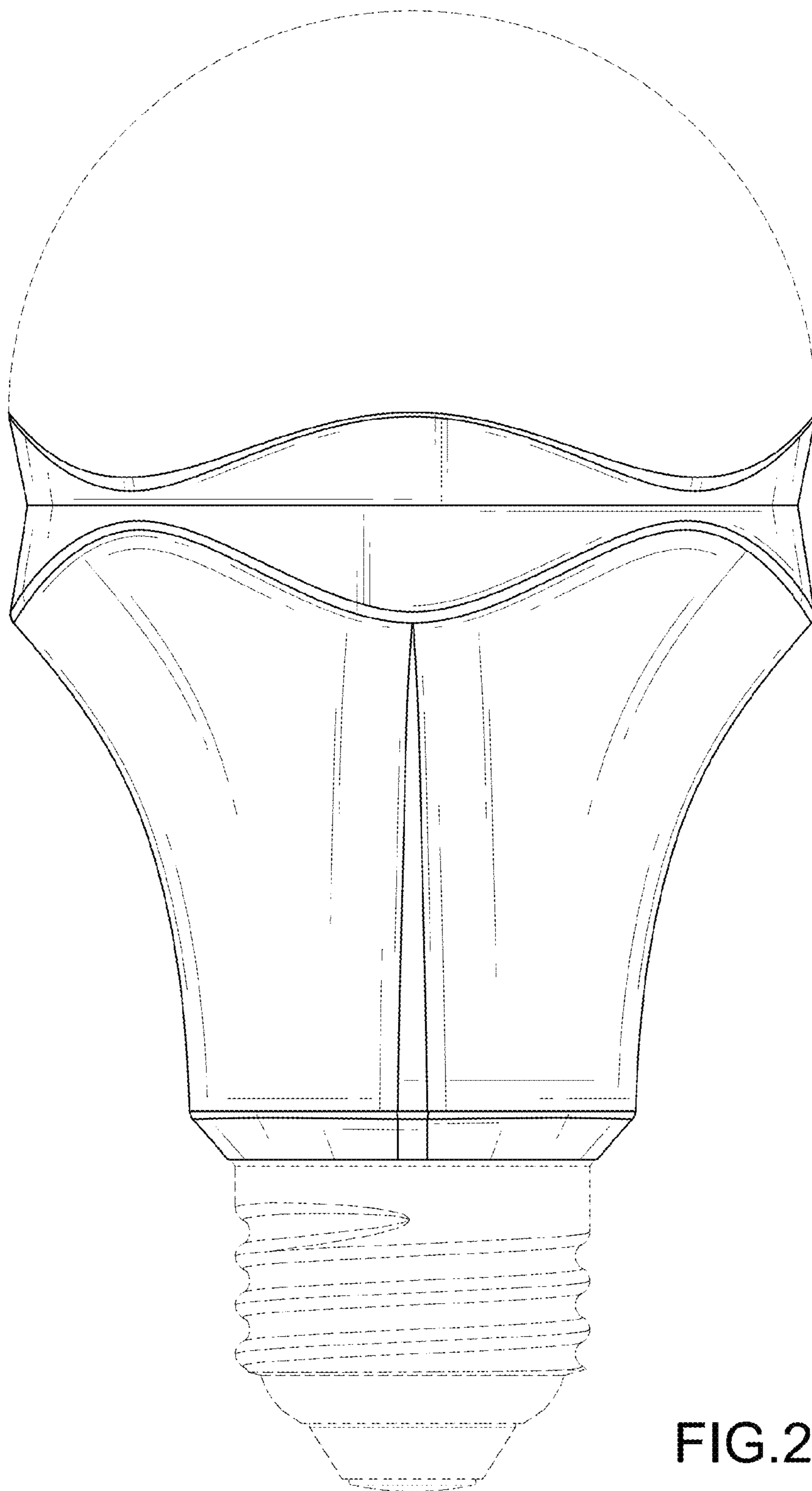

FIG. 2

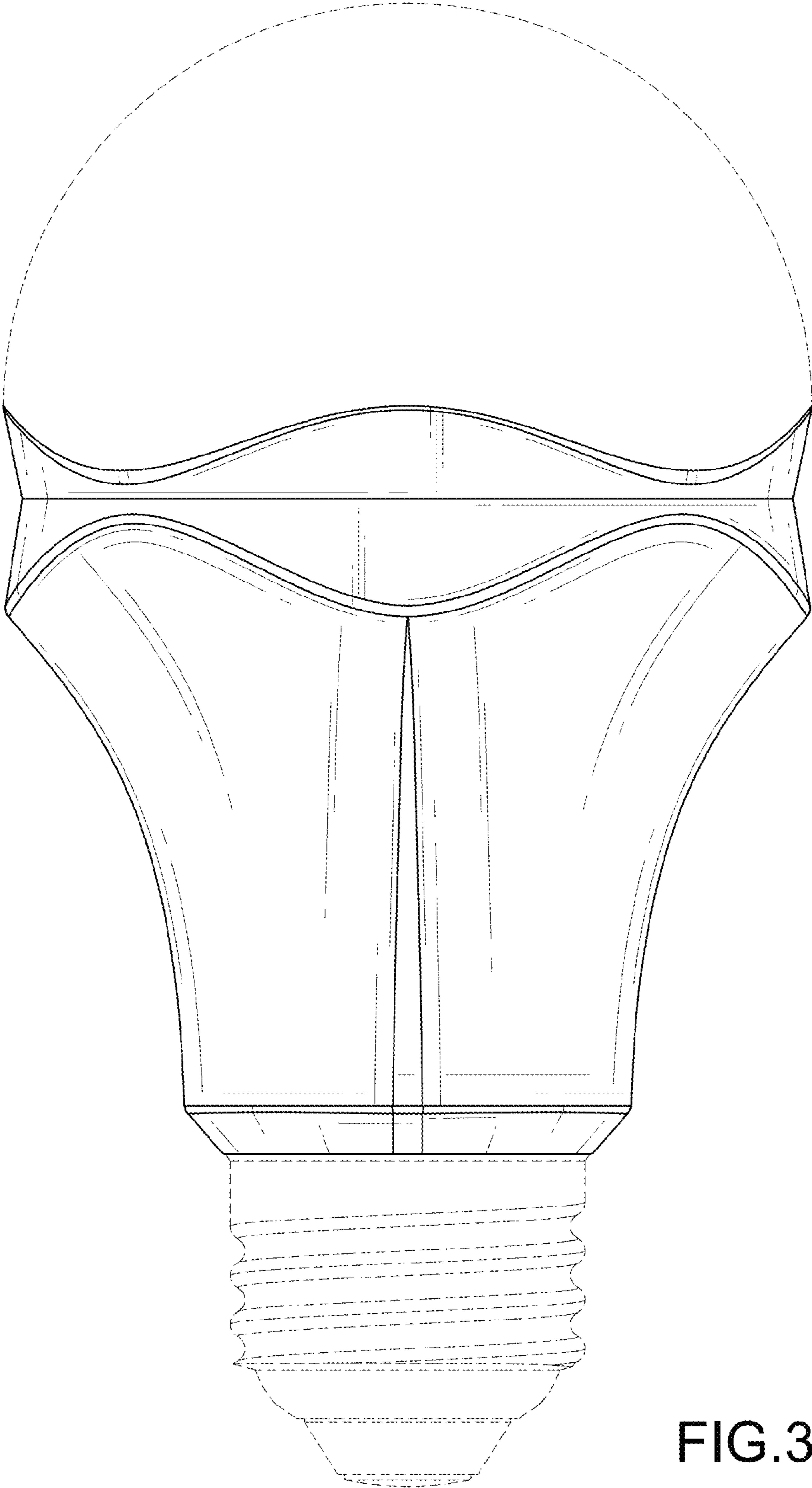

FIG. 3

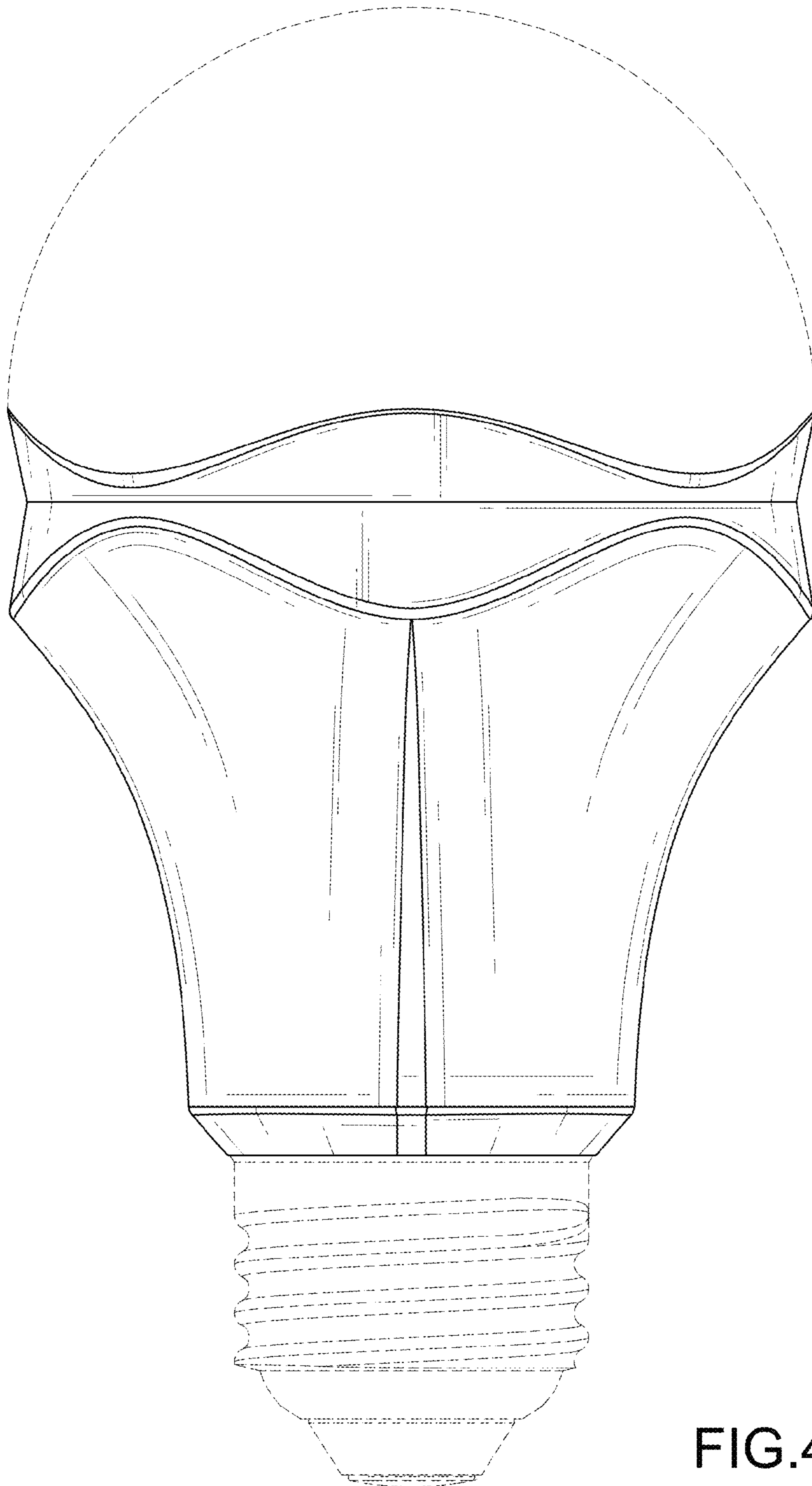

FIG. 4

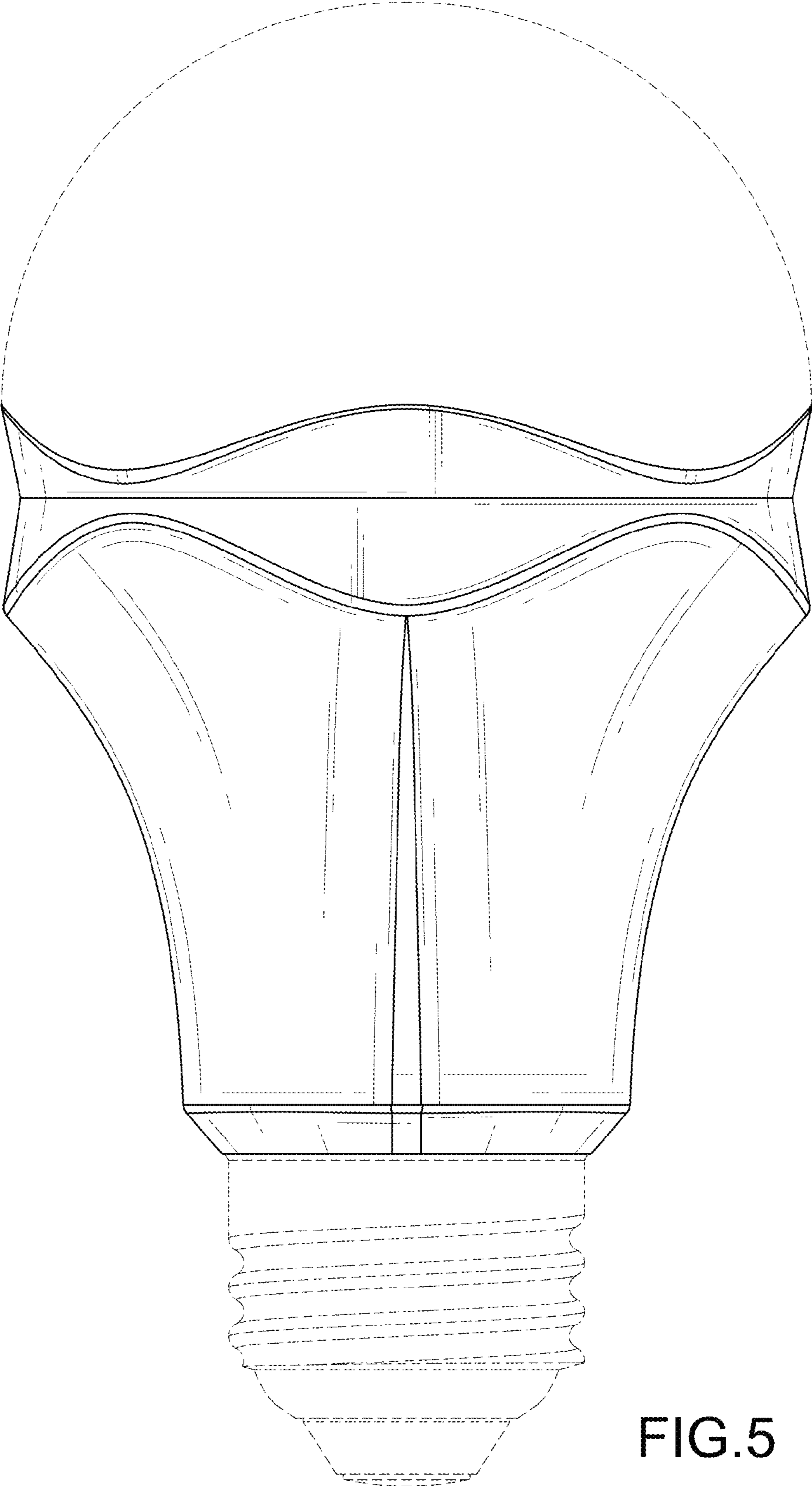
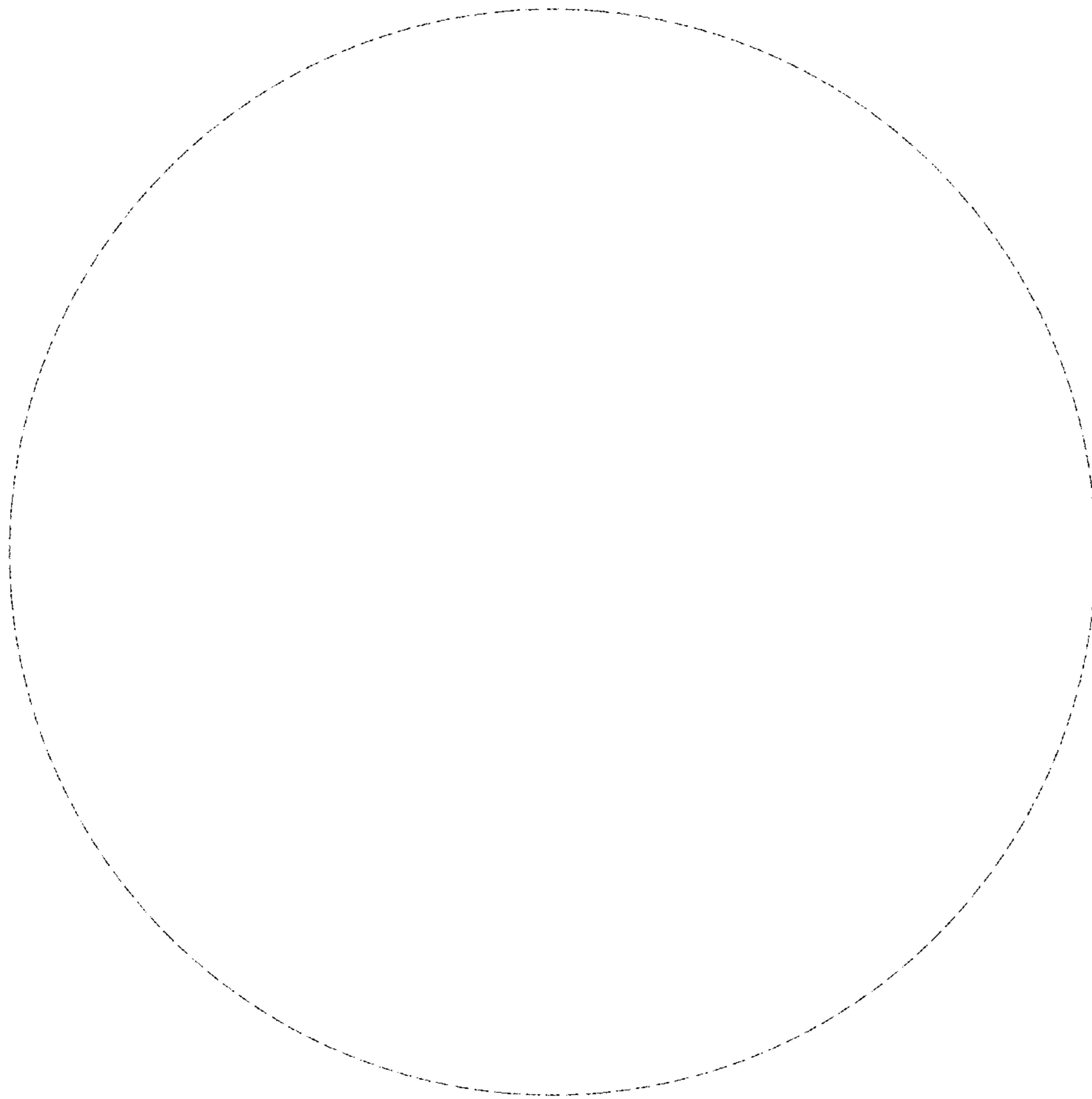

FIG.5



**FIG.6**

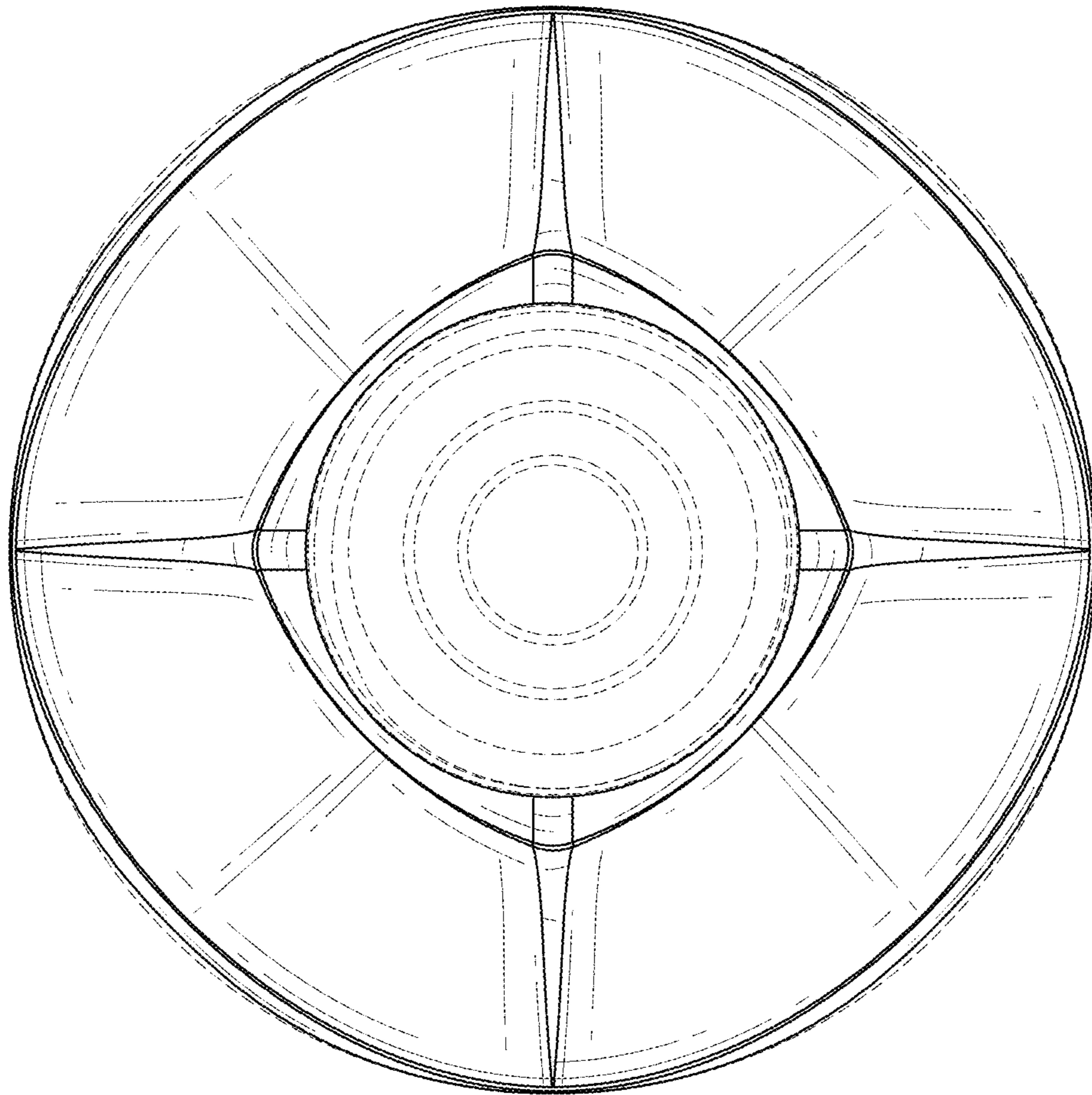

FIG.7



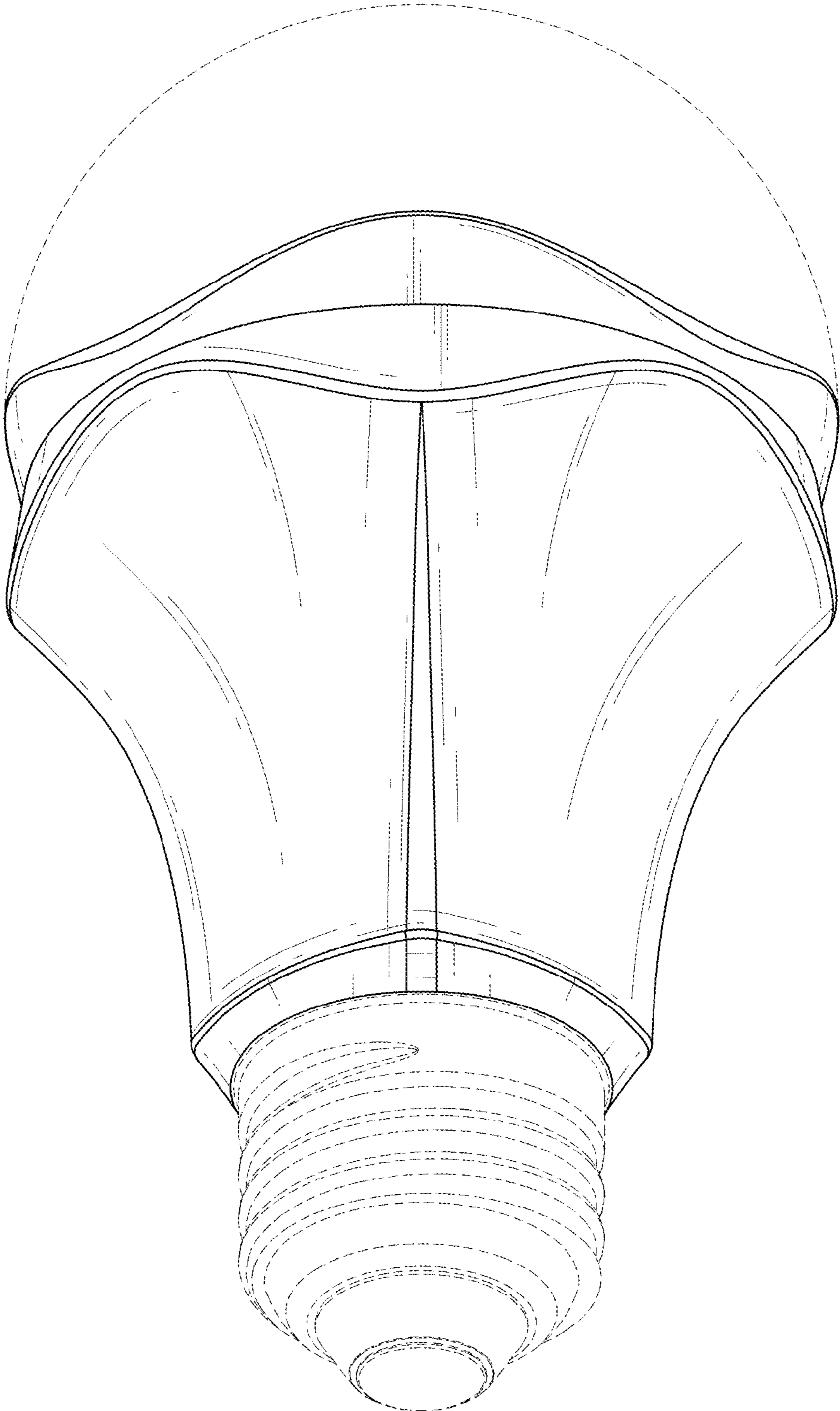

FIG.8