



US00D761439S

(12) **United States Design Patent**  
**Ruiz Robles**

(10) **Patent No.:** **US D761,439 S**  
(45) **Date of Patent:** **\*\* Jul. 12, 2016**

(54) **APPARATUS AND EQUIPMENT FOR DOCTORS, HOSPITALS AND LABORATORIES**

- (71) Applicant: **Especialidades Medicas Myr, S.L.**, El Vendrell (ES)
- (72) Inventor: **Francisco Ruiz Robles**, El Vendrell (ES)
- (73) Assignee: **Especialidades Médicas Myr, S.L.**, El Vendrell (Tarragona) (ES)
- (\*\*) Term: **14 Years**
- (21) Appl. No.: **29/491,047**
- (22) Filed: **May 16, 2014**

(30) **Foreign Application Priority Data**

Nov. 18, 2013 (EM) ..... 002347302-0001

(51) **LOC (10) Cl.** ..... **24-01**

(52) **U.S. Cl.**  
USPC ..... **D24/232**

(58) **Field of Classification Search**

USPC ..... D24/231-232, 216, 234, 186; D10/81; 422/50, 67, 62, 68.1, 145, 147, 146, 422/500, 565-566

CPC ..... C12Q 2527/125; C12Q 1/6806; C12Q 1/6809; C12A 1/6869; C12A 1/686; G01N 1/31; G01N 33/54366; G01N 35/10; G01N 35/00029; G01N 1/28; G01N 1/44; G01N 2035/00306

See application file for complete search history.

(56) **References Cited**

U.S. PATENT DOCUMENTS

4,626,684	A	*	12/1986	Landa	.....	250/328
D338,419	S	*	8/1993	Frenkel et al.	.....	D10/81
D380,273	S	*	6/1997	Emerson et al.	.....	D24/232
D381,756	S	*	7/1997	Ohnuma et al.	.....	D24/232
D471,988	S	*	3/2003	Lueth et al.	.....	D24/232
D479,879	S	*	9/2003	Dickinson	.....	D24/232
D584,975	S	*	1/2009	Haberstroh	.....	D10/81
D693,020	S	*	11/2013	Degn	.....	D24/216

\* cited by examiner

*Primary Examiner* — Wan Laymon

(74) *Attorney, Agent, or Firm* — Davis & Bujold PLLC; Michael J. Bujold

(57) **CLAIM**

The ornamental design for an apparatus and equipment for doctors, hospitals and laboratories, as shown and described.

**DESCRIPTION**

FIG. 1 is a front and top perspective view of an apparatus and equipment for doctors, hospitals and laboratories showing my new design;

FIG. 2 is a right side elevational view thereof;

FIG. 3 is a left side elevational view thereof;

FIG. 4 is a bottom plan view thereof;

FIG. 5 is a top plan view thereof;

FIG. 6 is a perspective view thereof from the front, top and right side; and,

FIG. 7 is a rear elevational view thereof.

The broken lines shown in the figures are included for the purpose of illustrating portions of the apparatus and equipment for doctors, hospitals and laboratories and form no part of the claimed design.

**1 Claim, 7 Drawing Sheets**

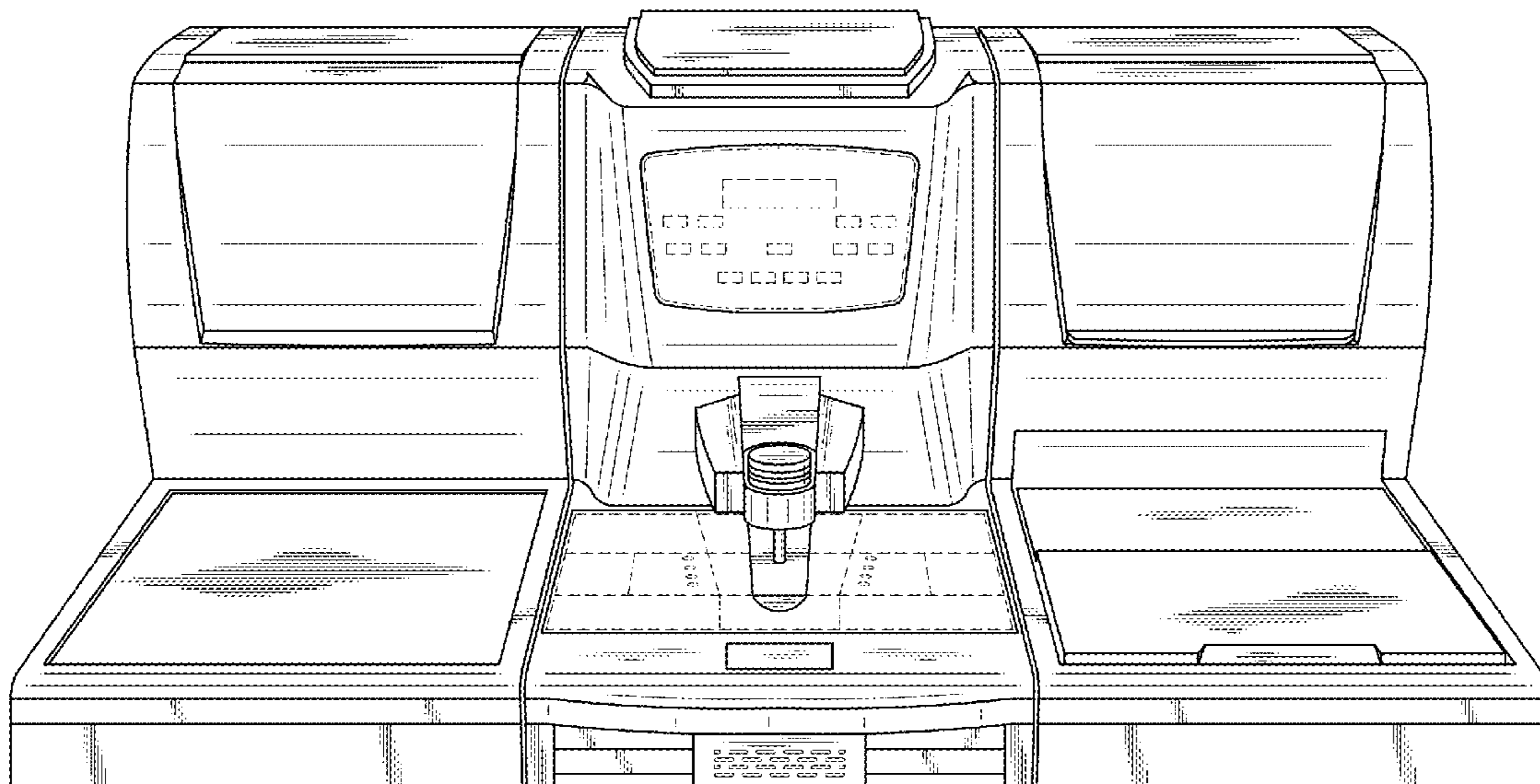

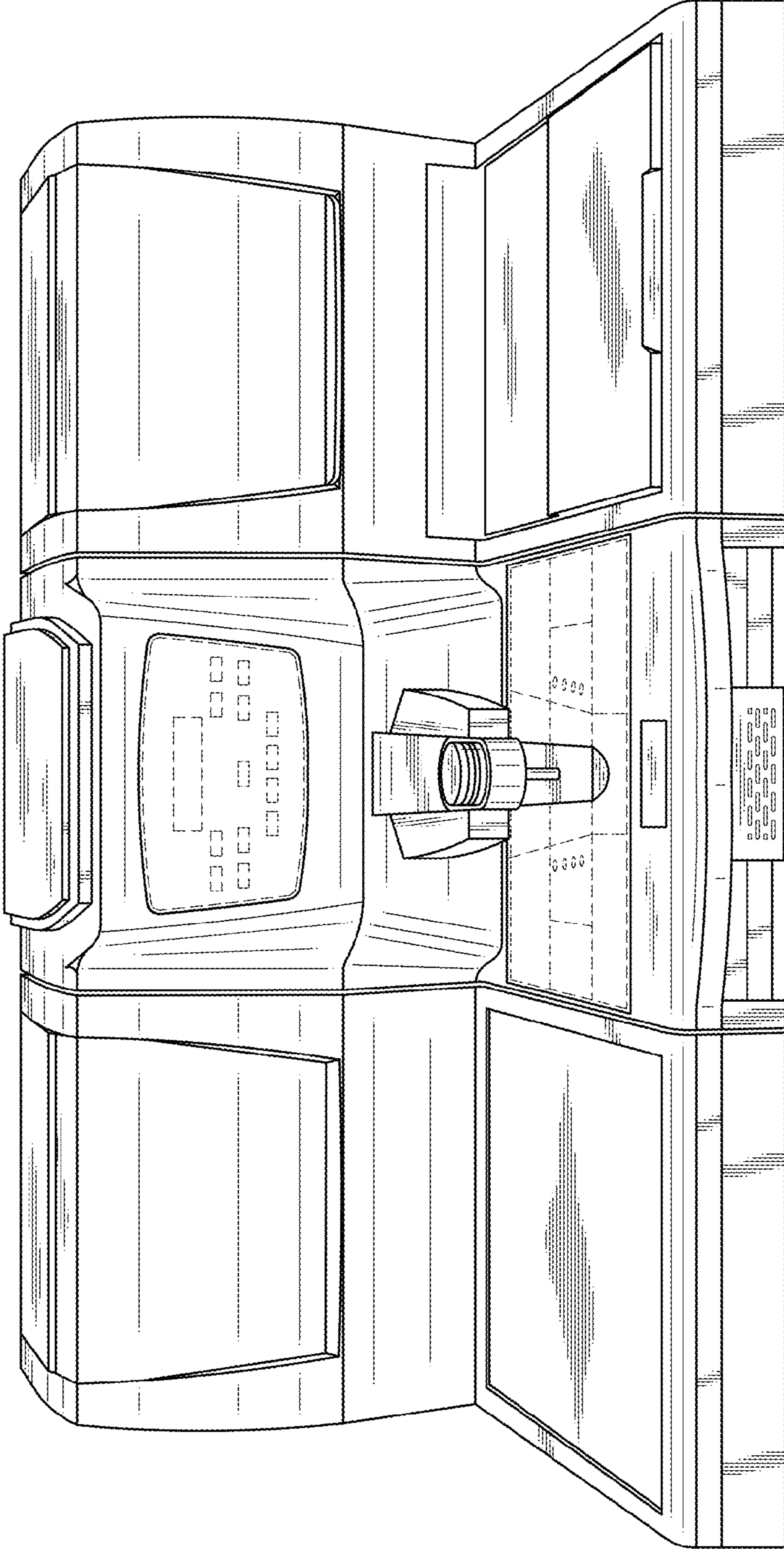

FIG.1

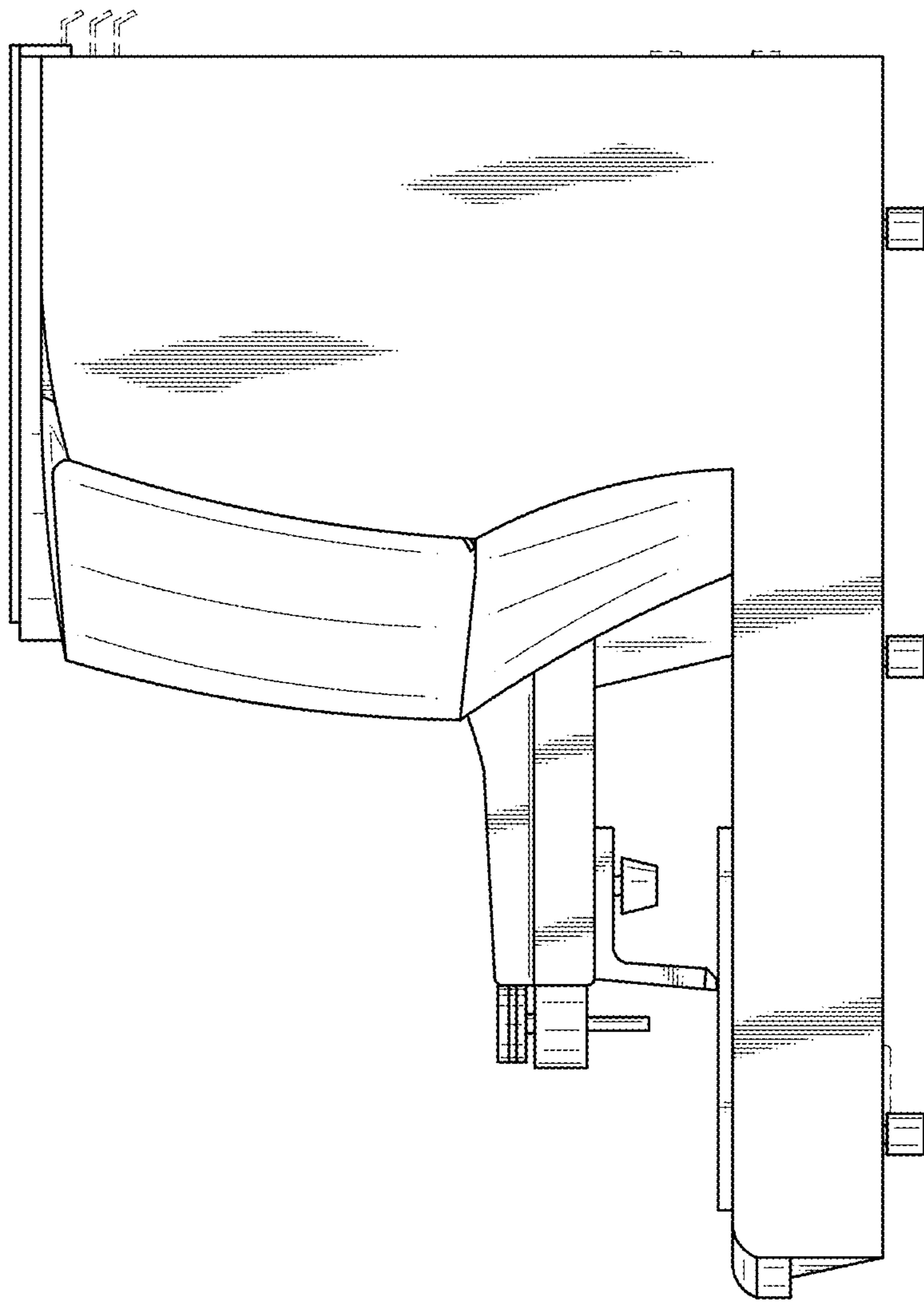

FIG.2

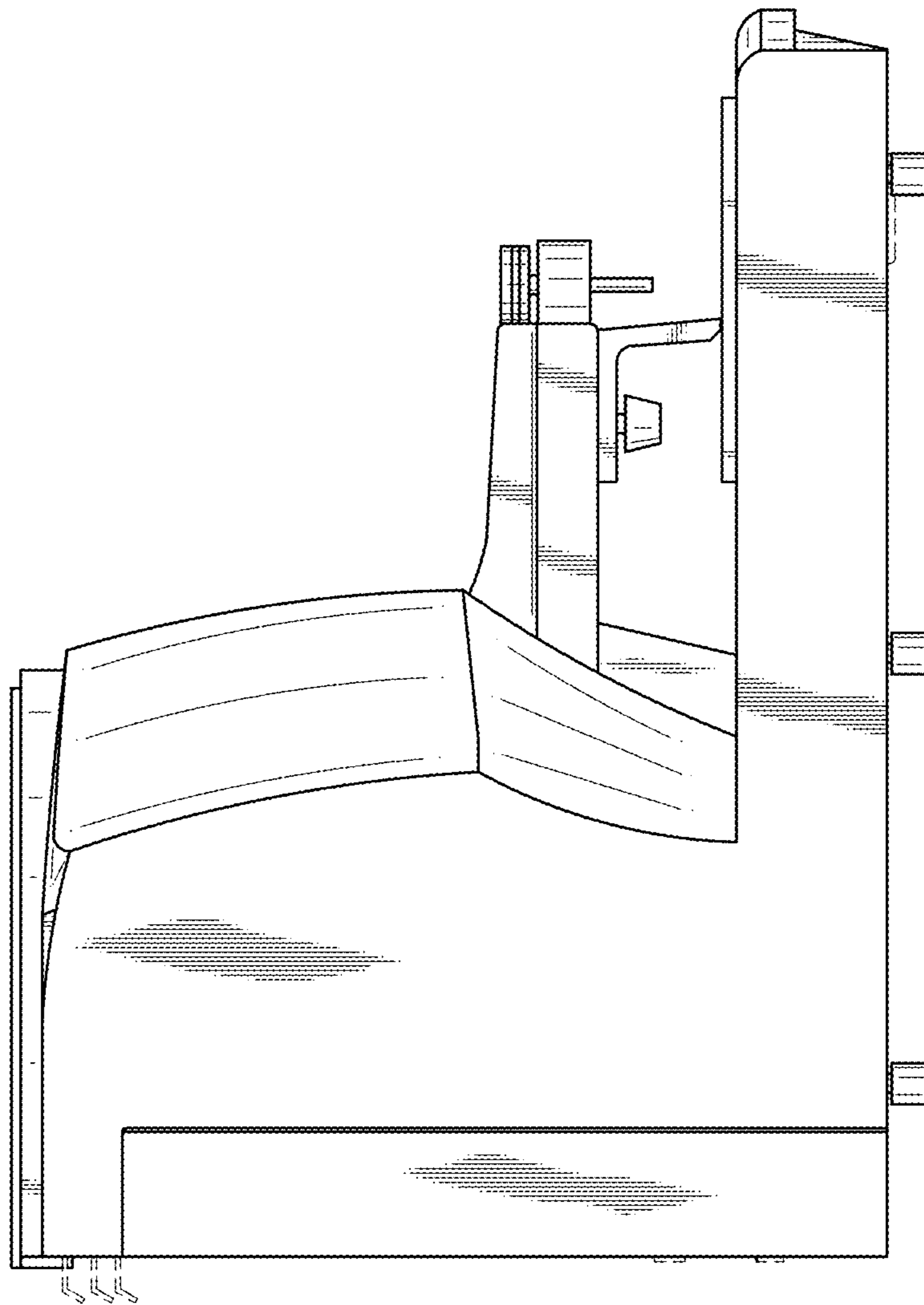

FIG.3

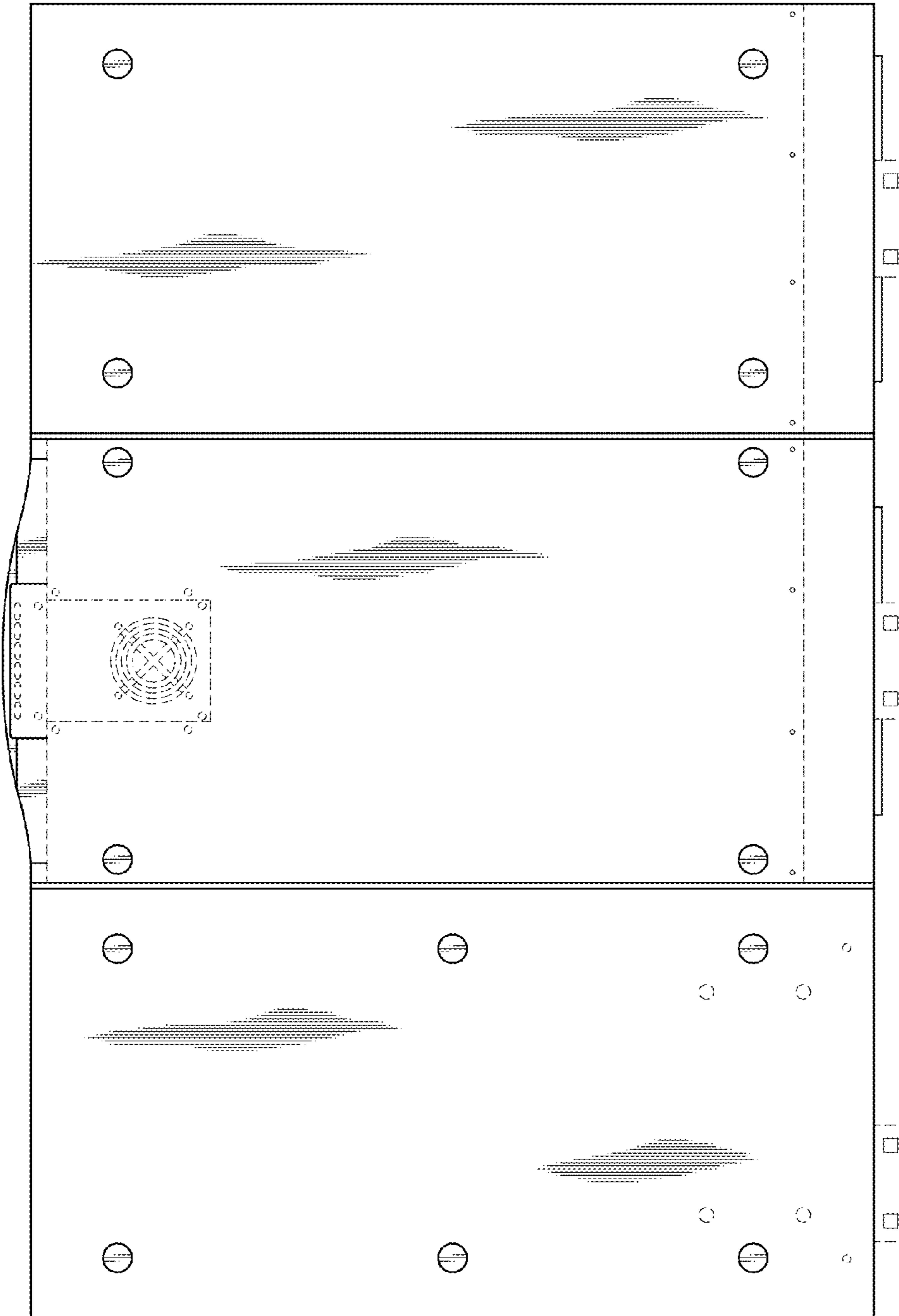

FIG.4

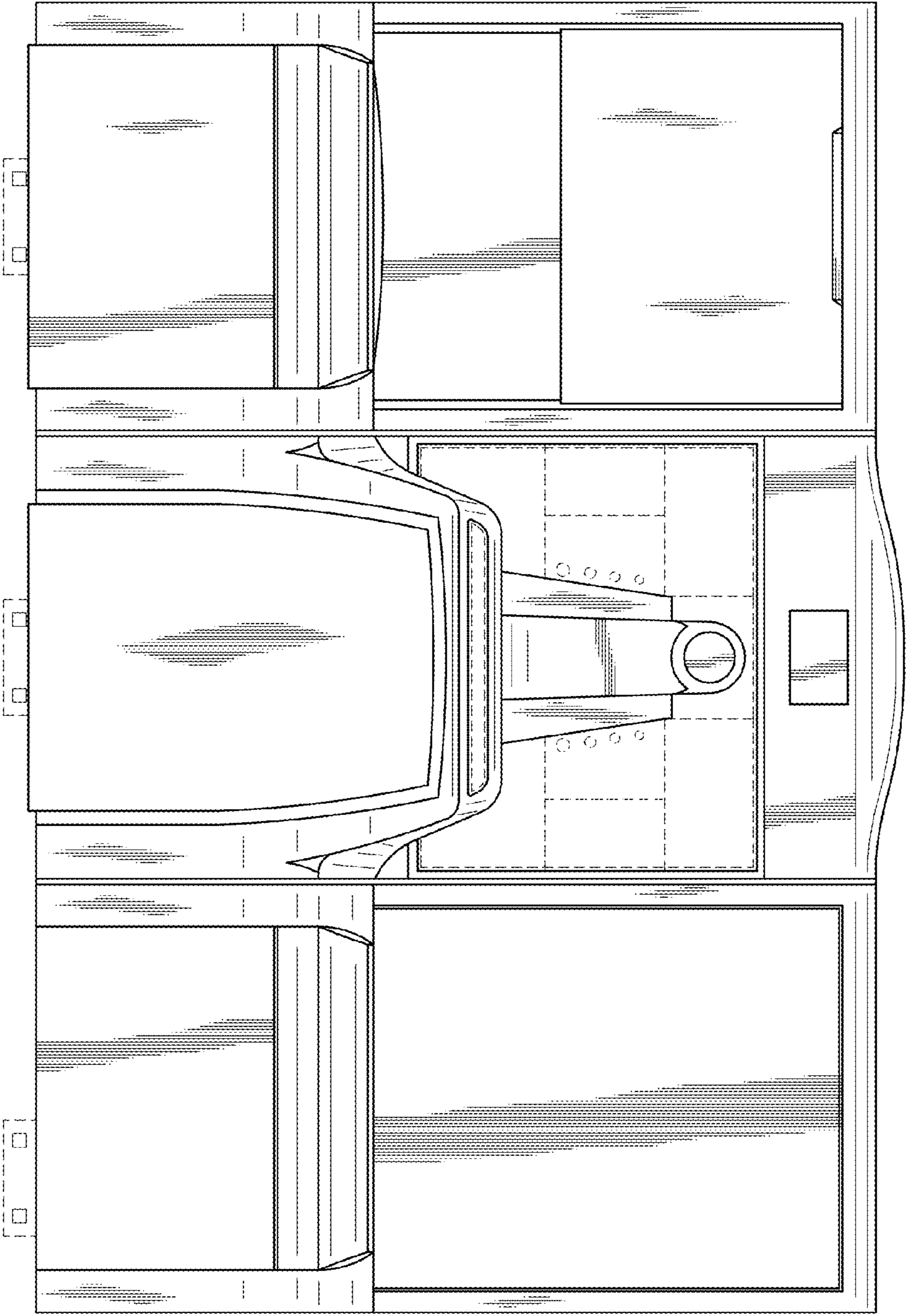

FIG.5

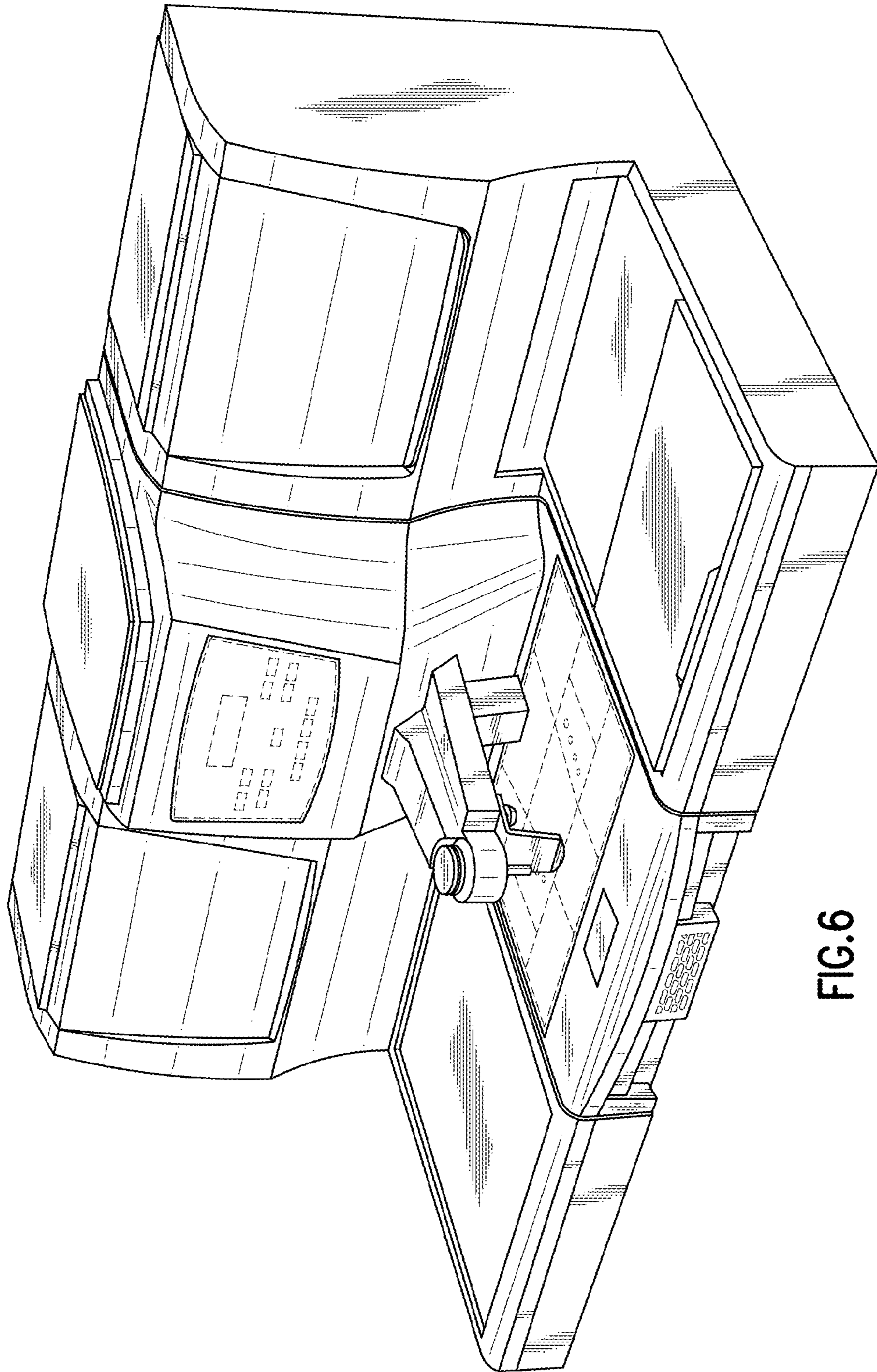

FIG.6

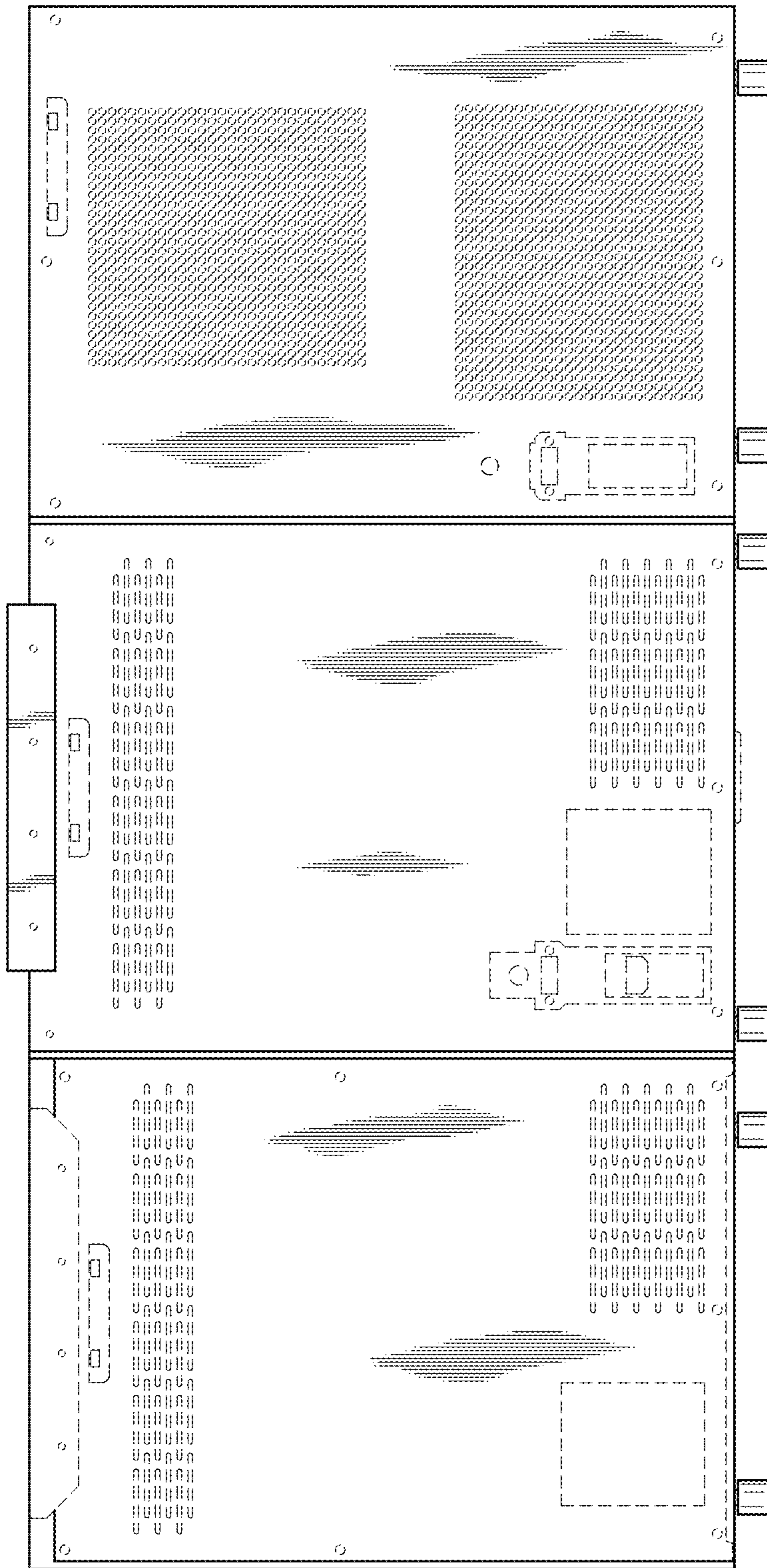

FIG. 7