



US00D761155S

(12) **United States Design Patent**  
**Agar**

(10) **Patent No.:** **US D761,155 S**  
(45) **Date of Patent:** **\*\* Jul. 12, 2016**

(54) **PLANTER**  
(71) Applicant: **Graydon Lansford Agar**, Seattle, WA  
(US)  
(72) Inventor: **Graydon Lansford Agar**, Seattle, WA  
(US)  
(\*\*) Term: **14 Years**  
(21) Appl. No.: **29/518,638**  
(22) Filed: **Feb. 25, 2015**  
(51) **LOC (10) Cl.** ..... **11-02**  
(52) **U.S. Cl.**  
USPC ..... **D11/143**  
(58) **Field of Classification Search**  
USPC ..... D6/403–405, 556–558, 683;  
D11/143–156, 164; D7/587  
CPC ..... A01G 9/02; A01G 9/021; A01G 9/022;  
A01G 9/023; A01G 9/024; A01G 9/028;  
A01G 9/04; A01G 9/042; A01G 9/10; A01G  
9/12  
See application file for complete search history.

D268,337 S \* 3/1983 Tenzer ..... D11/143  
D272,882 S \* 3/1984 Gardner ..... D7/603  
D302,295 S \* 7/1989 Hanifl ..... D11/143  
D357,886 S \* 5/1995 Fuller ..... D11/152  
5,444,940 A \* 8/1995 White-Wexler ..... A01G 9/00  
47/65.5  
D365,300 S \* 12/1995 Bransky ..... D11/143  
D421,462 S \* 3/2000 Orchanian ..... D19/77  
D447,304 S \* 8/2001 Niemeyer ..... D34/1  
D518,938 S \* 4/2006 Freitag ..... D34/8  
D525,166 S \* 7/2006 Cordeiro ..... D11/143  
D601,836 S \* 10/2009 Carr ..... D6/525  
D706,345 S \* 6/2014 Hu ..... D19/75  
8,943,657 B1 \* 2/2015 Perry ..... 27/1

\* cited by examiner

*Primary Examiner* — Elizabeth Albert  
(74) *Attorney, Agent, or Firm* — Richard A. Koske; Foster  
Pepper PLLC

(57) **CLAIM**  
The ornamental design for a planter, as shown and described.

**DESCRIPTION**

FIG. 1 is a front perspective view of a planter showing my new design;  
FIG. 2 is a front elevation view thereof;  
FIG. 3 is a right side elevation thereof;  
FIG. 4 is a left side elevation view thereof;  
FIG. 5 is a back elevation view thereof;  
FIG. 6 is a top plan view thereof; and,  
FIG. 7 is a bottom plan view thereof.  
The broken lines in FIG. 6 are included for the purpose of showing portions of the planter that form no part of the claimed design.

(56) **References Cited**  
U.S. PATENT DOCUMENTS  
580,447 A \* 4/1897 Besuner ..... B65D 21/0204  
220/23.4  
D46,645 S \* 11/1914 Traylor ..... D11/152  
2,613,517 A \* 10/1952 Frantz ..... A47G 19/22  
220/23.2  
2,799,972 A \* 7/1957 Teixeira ..... A01G 9/027  
220/23.4  
3,648,875 A \* 3/1972 Lundgren ..... B65F 1/06  
220/23.4

**1 Claim, 7 Drawing Sheets**

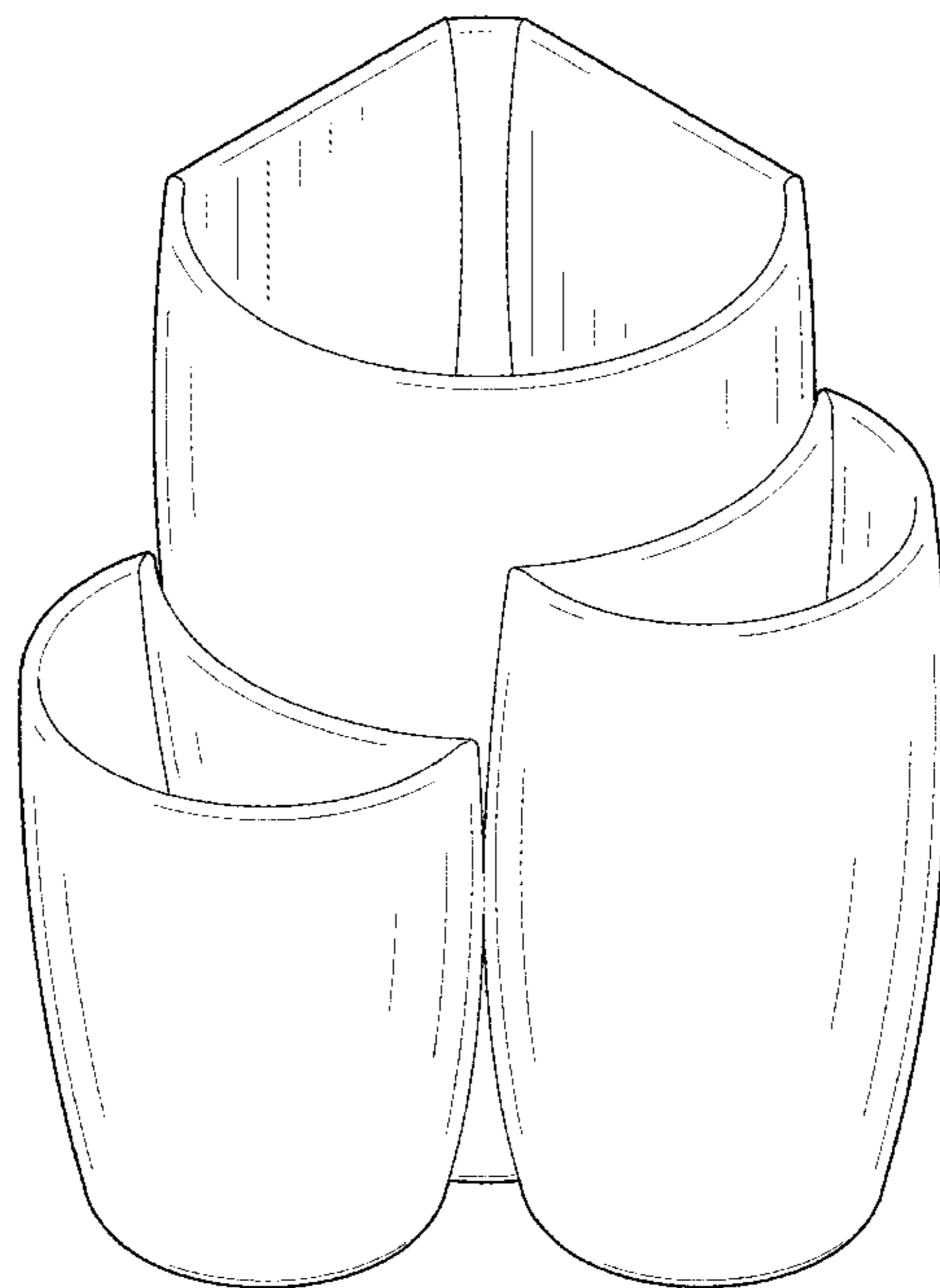

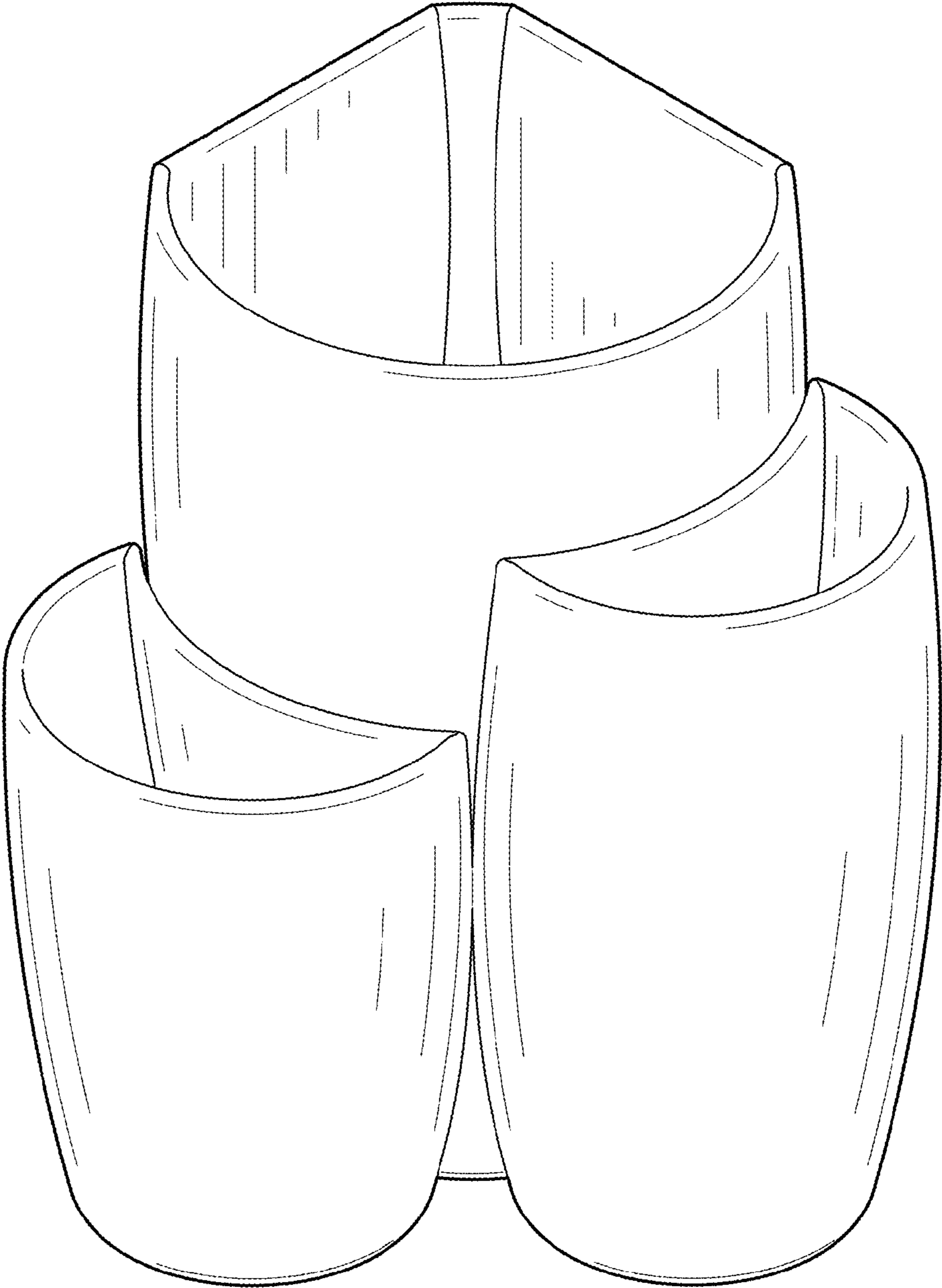

FIG.1

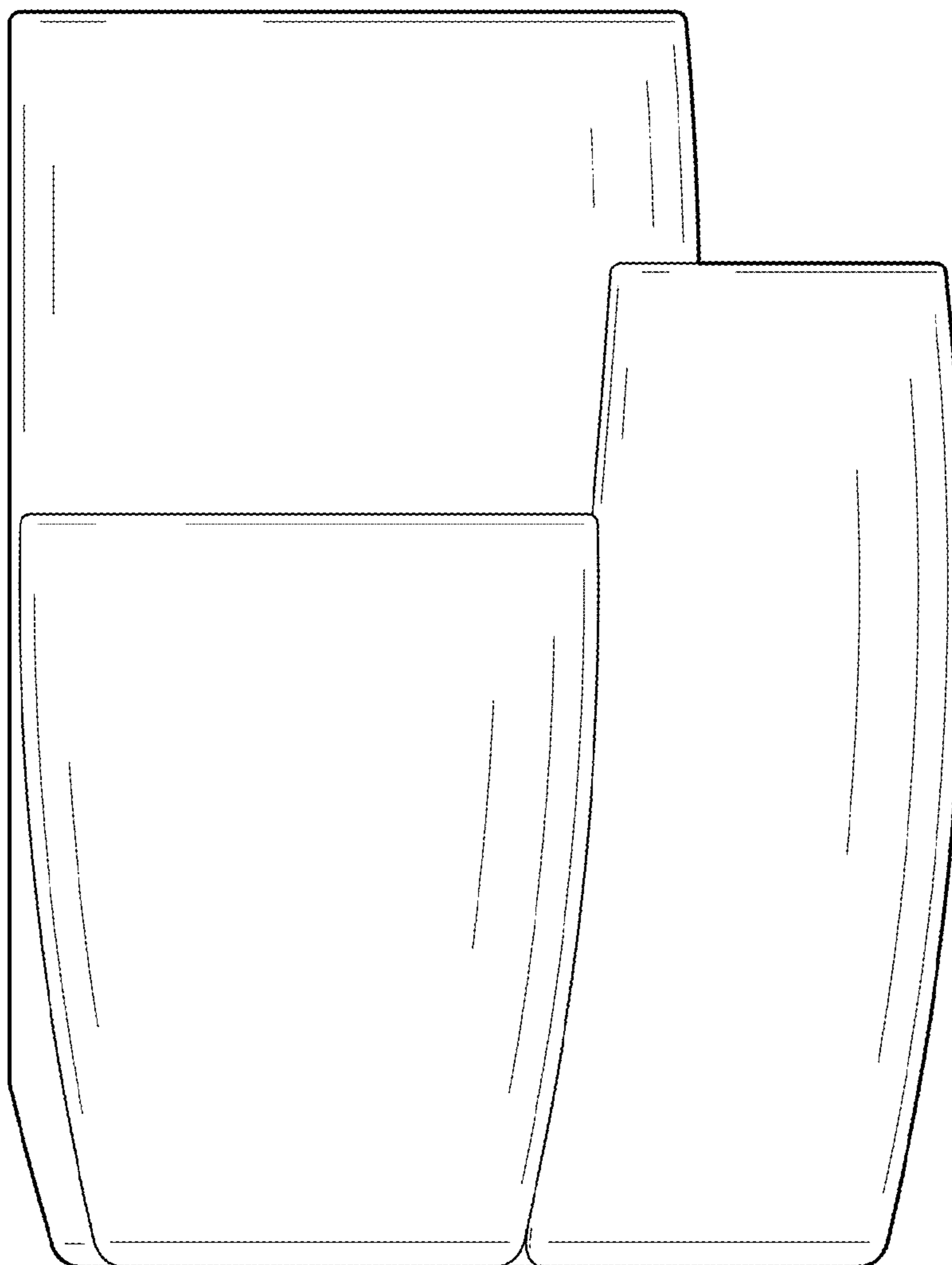

FIG.2

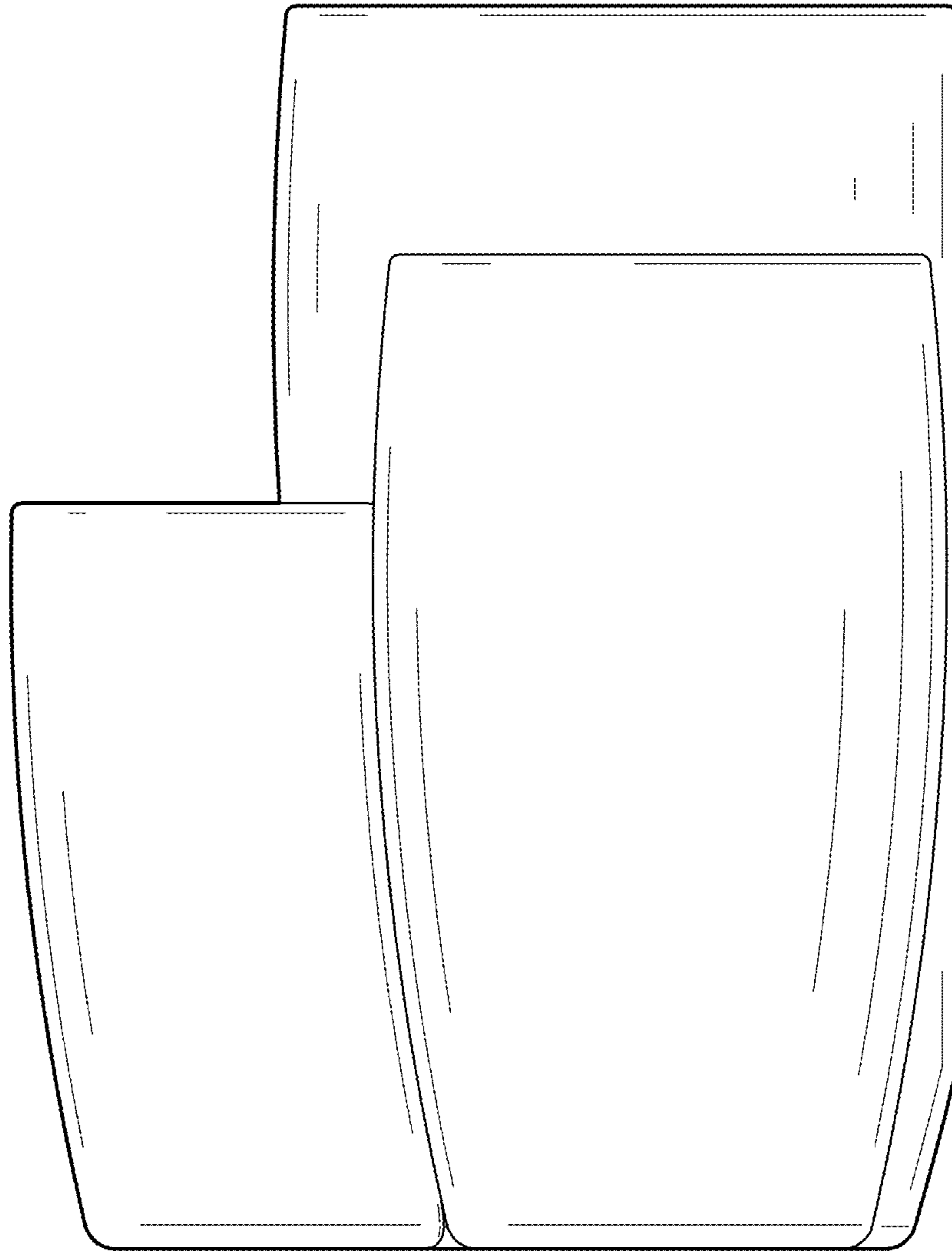

FIG. 3

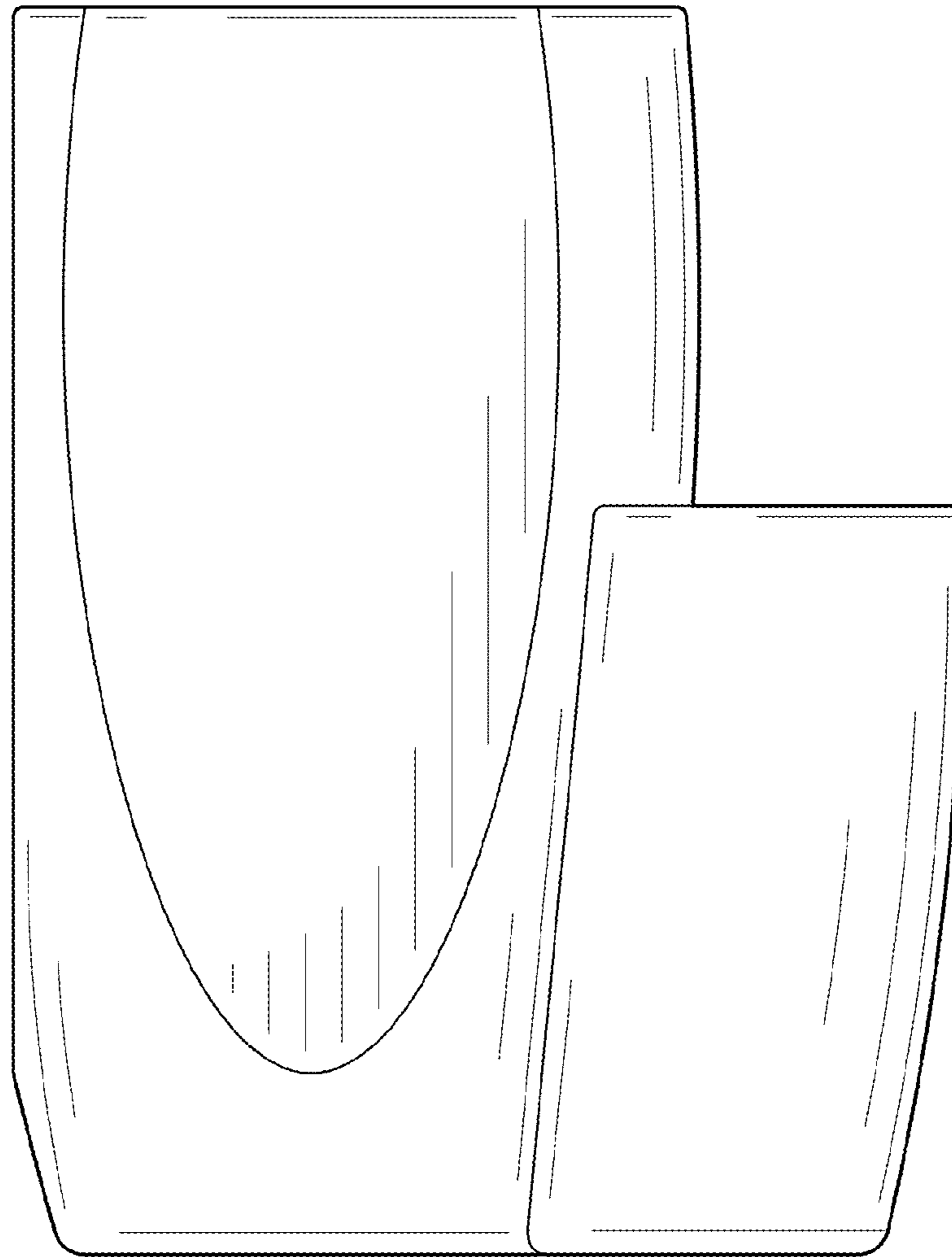

FIG.4

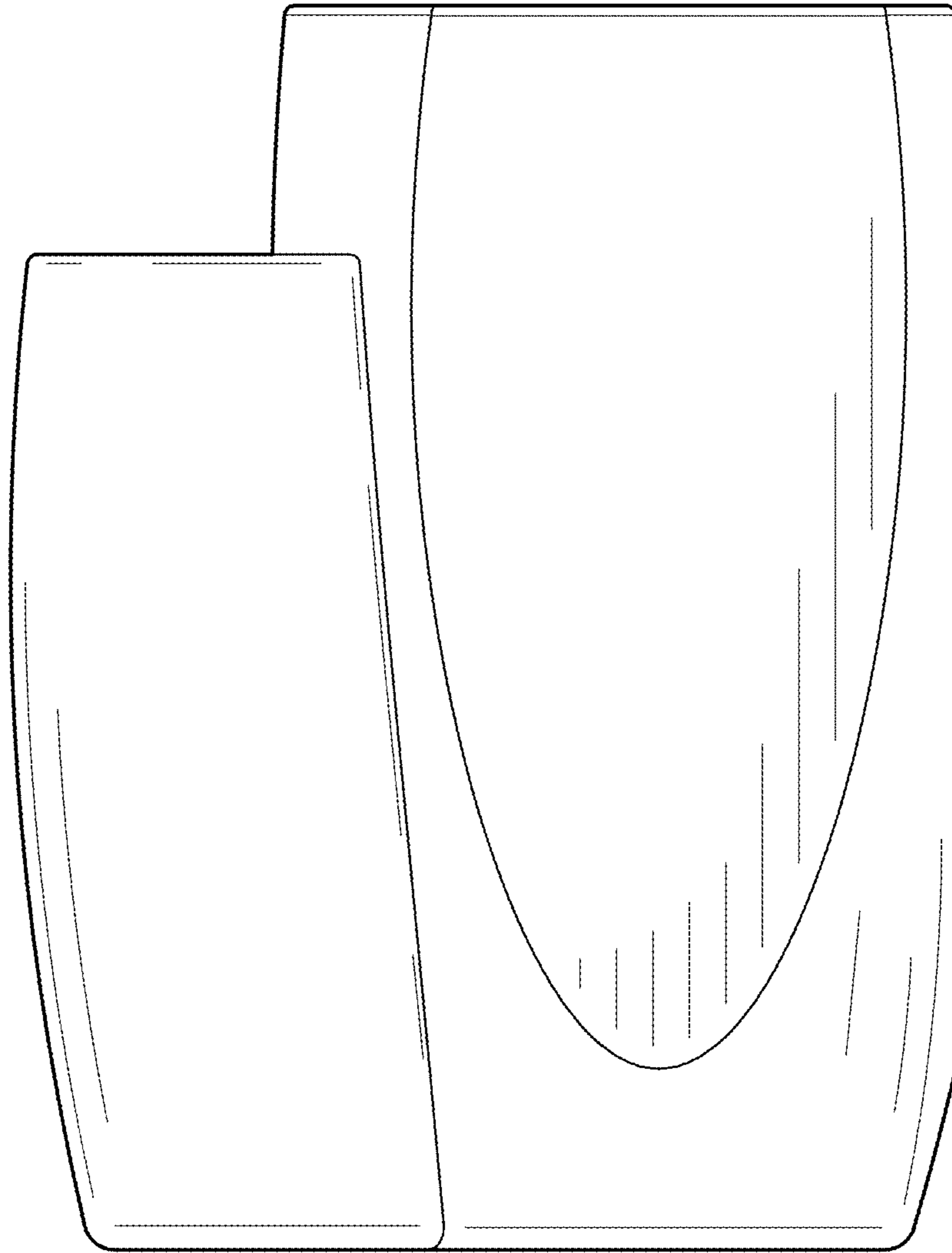

FIG. 5

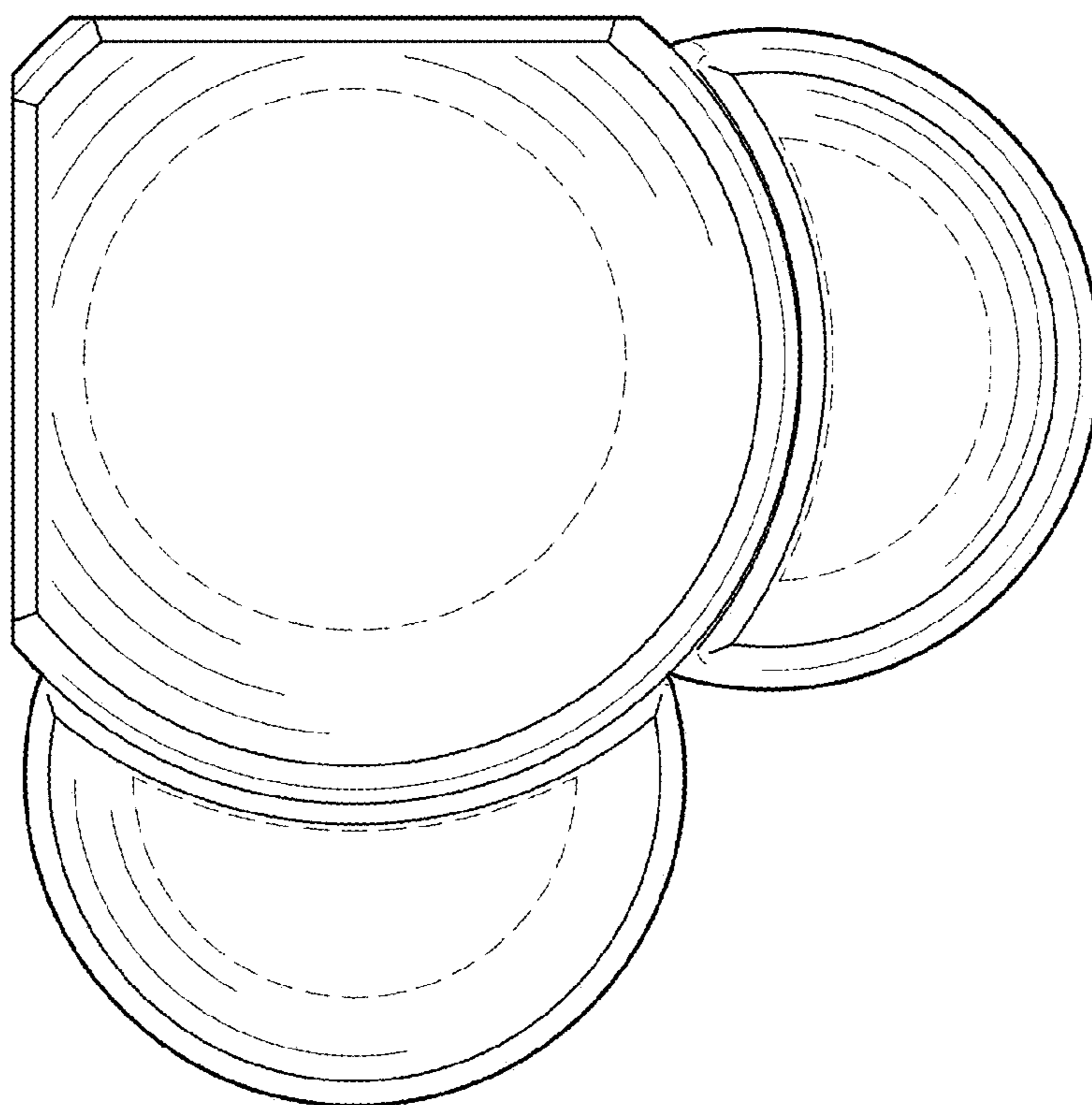

FIG.6

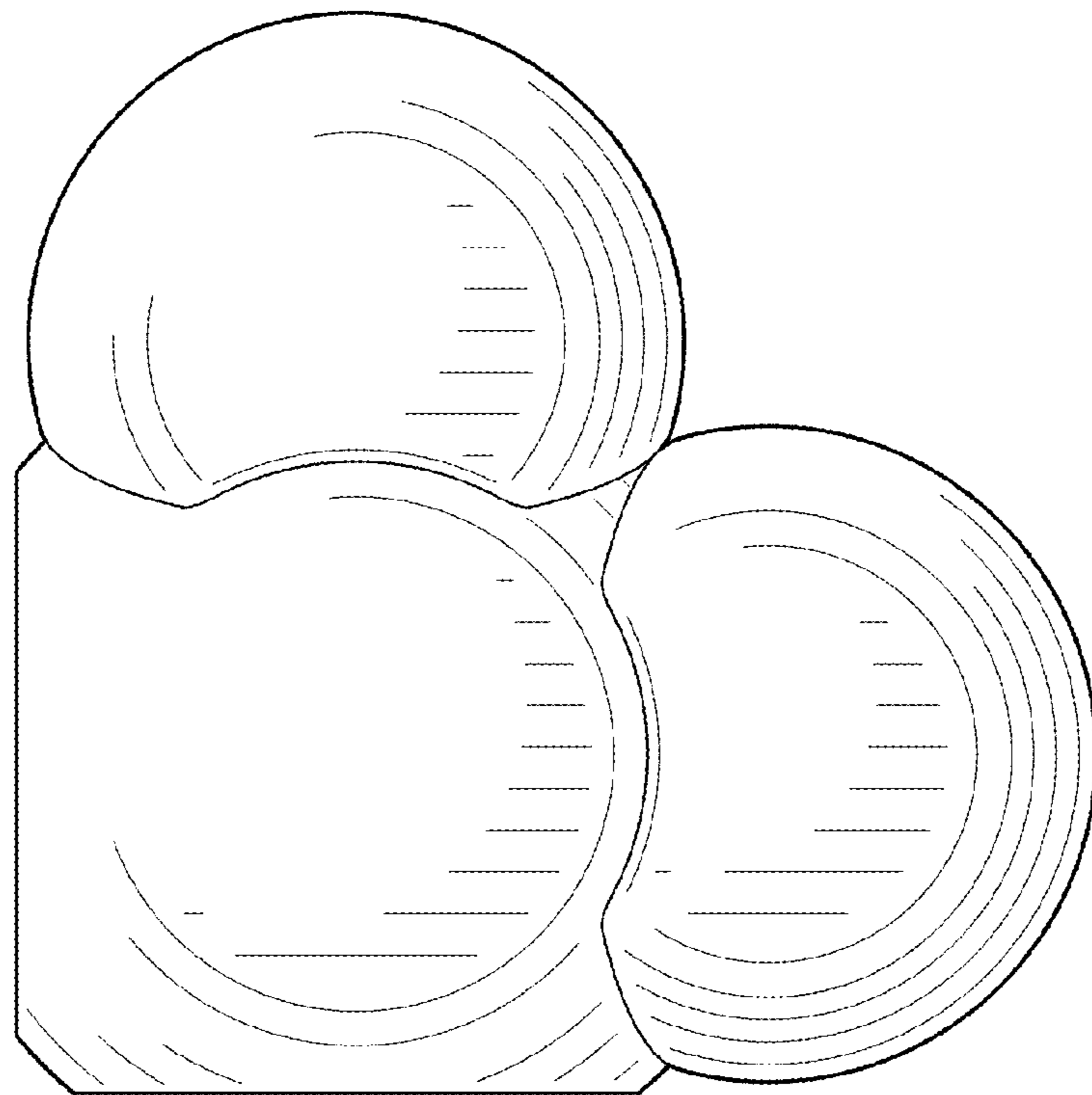

FIG. 7