



US00D761050S

(12) **United States Design Patent**
Pan

(10) **Patent No.:** **US D761,050 S**
(45) **Date of Patent:** **** Jul. 12, 2016**

- (54) **BACKREST FOR A CHAIR**
- (71) Applicant: **Oasyschair Co., Ltd.**, Tainan (TW)
- (72) Inventor: **Toung-Chun Pan**, Tainan (TW)
- (73) Assignee: **Oasyschair Co., Ltd.**, Tainan (TW)
- (**) Term: **14 Years**
- (21) Appl. No.: **29/525,671**
- (22) Filed: **May 1, 2015**
- (51) **LOC (10) Cl.** **06-01**
- (52) **U.S. Cl.**
USPC **D6/716.4**
- (58) **Field of Classification Search**
USPC D6/334–336, 366, 371–373, 374, 376,
D6/379, 380, 716, 716.1, 716.3, 716.4
CPC A47C 3/04; A47C 4/02; A47C 4/03;
A47C 7/022; A47C 7/16; A47C 7/40
See application file for complete search history.

- D561,485 S * 2/2008 Hock D6/379
- D574,646 S * 8/2008 Su D6/373
- D586,577 S * 2/2009 Koh D6/376
- D595,072 S * 6/2009 Su D6/716.4
- D595,520 S * 7/2009 Su D6/716.4
- D603,196 S * 11/2009 Su D6/366

* cited by examiner

Primary Examiner — Mimoso De
(74) *Attorney, Agent, or Firm* — Alan D. Kamrath; Kamrath IP Lawfirm, P.A.

- (56) **References Cited**
U.S. PATENT DOCUMENTS
D449,172 S * 10/2001 Van De Riet D6/366
D449,938 S * 11/2001 Vanderiet D6/380
D456,164 S * 4/2002 Vanderiet D6/374
D505,801 S * 6/2005 Cesaroni D6/379
D512,238 S * 12/2005 Chen D6/379
D541,067 S * 4/2007 Lin D6/373
D549,479 S * 8/2007 Su D6/373

(57) **CLAIM**
The ornamental design for backrest for a chair, as shown and described.

DESCRIPTION

FIG. 1 is a perspective view of backrest for a chair showing my new design;
FIG. 2 is a front side elevational view thereof;
FIG. 3 is a rear side elevational view thereof;
FIG. 4 is a left side elevational view thereof;
FIG. 5 is a right side elevational view thereof;
FIG. 6 is a top plan view thereof; and,
FIG. 7 is a bottom plan view thereof.
The broken lines are shown for purposes of illustrating parts that form no part of the claimed design.

1 Claim, 5 Drawing Sheets

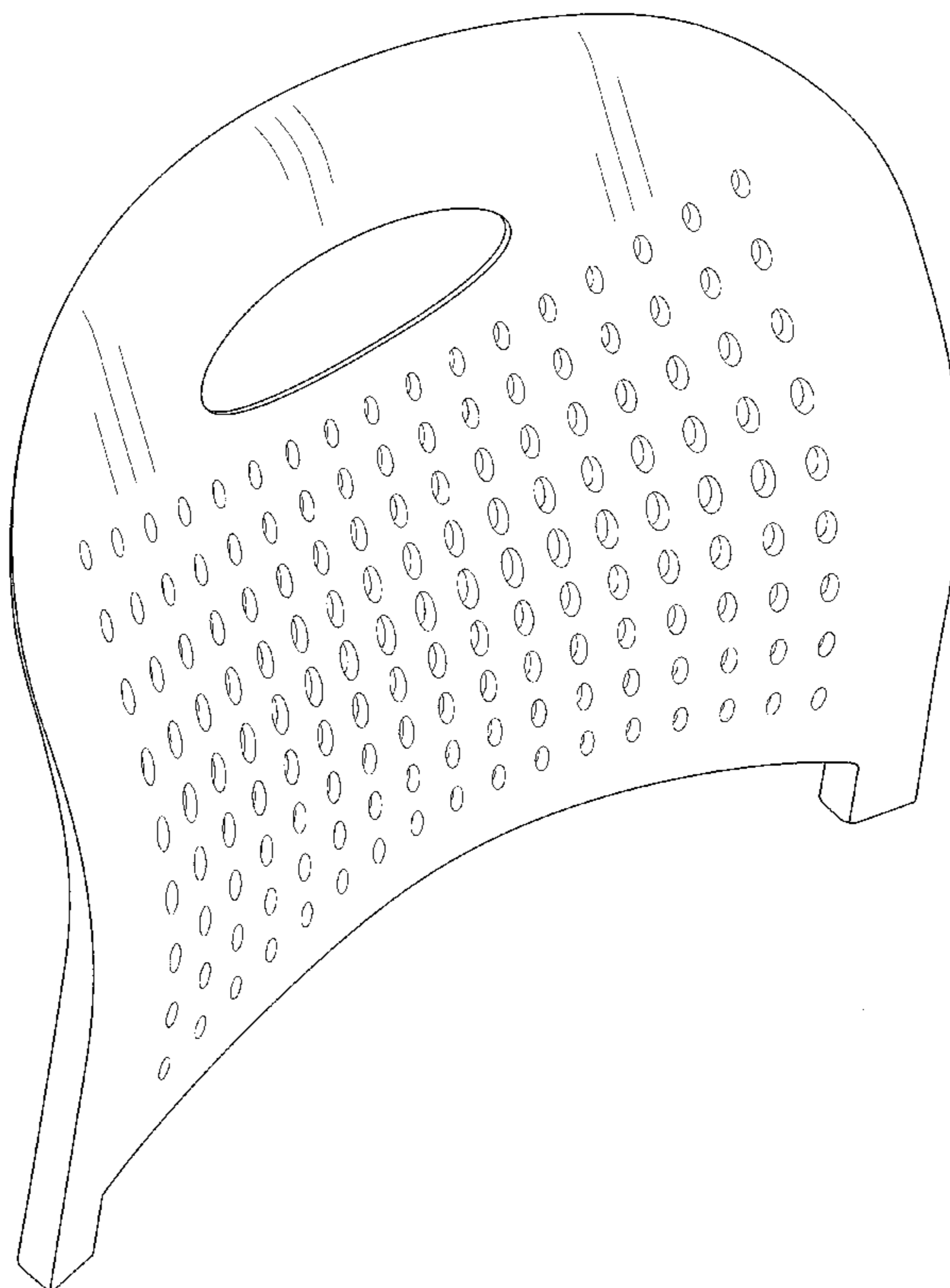

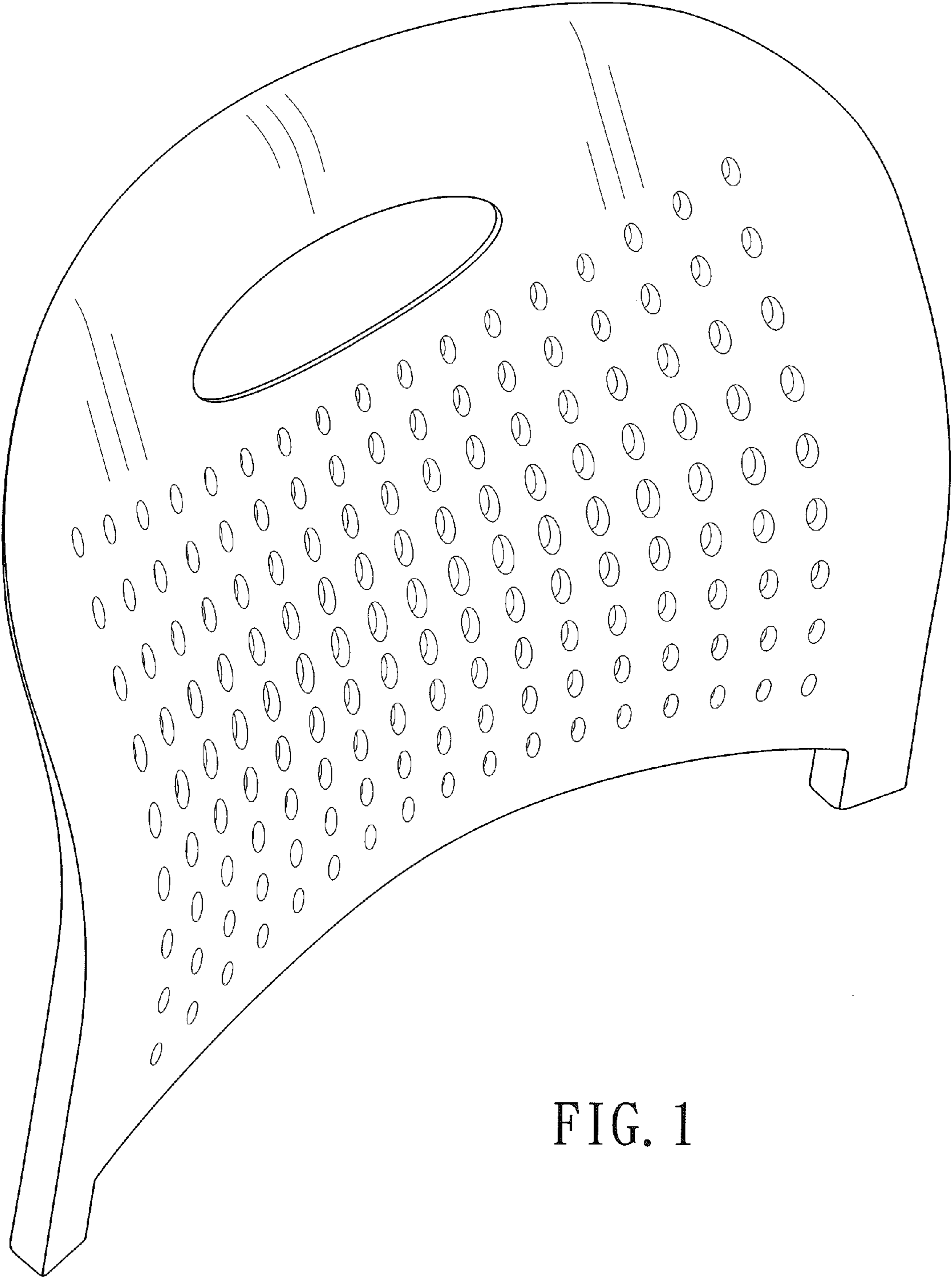

FIG. 1

FIG. 2

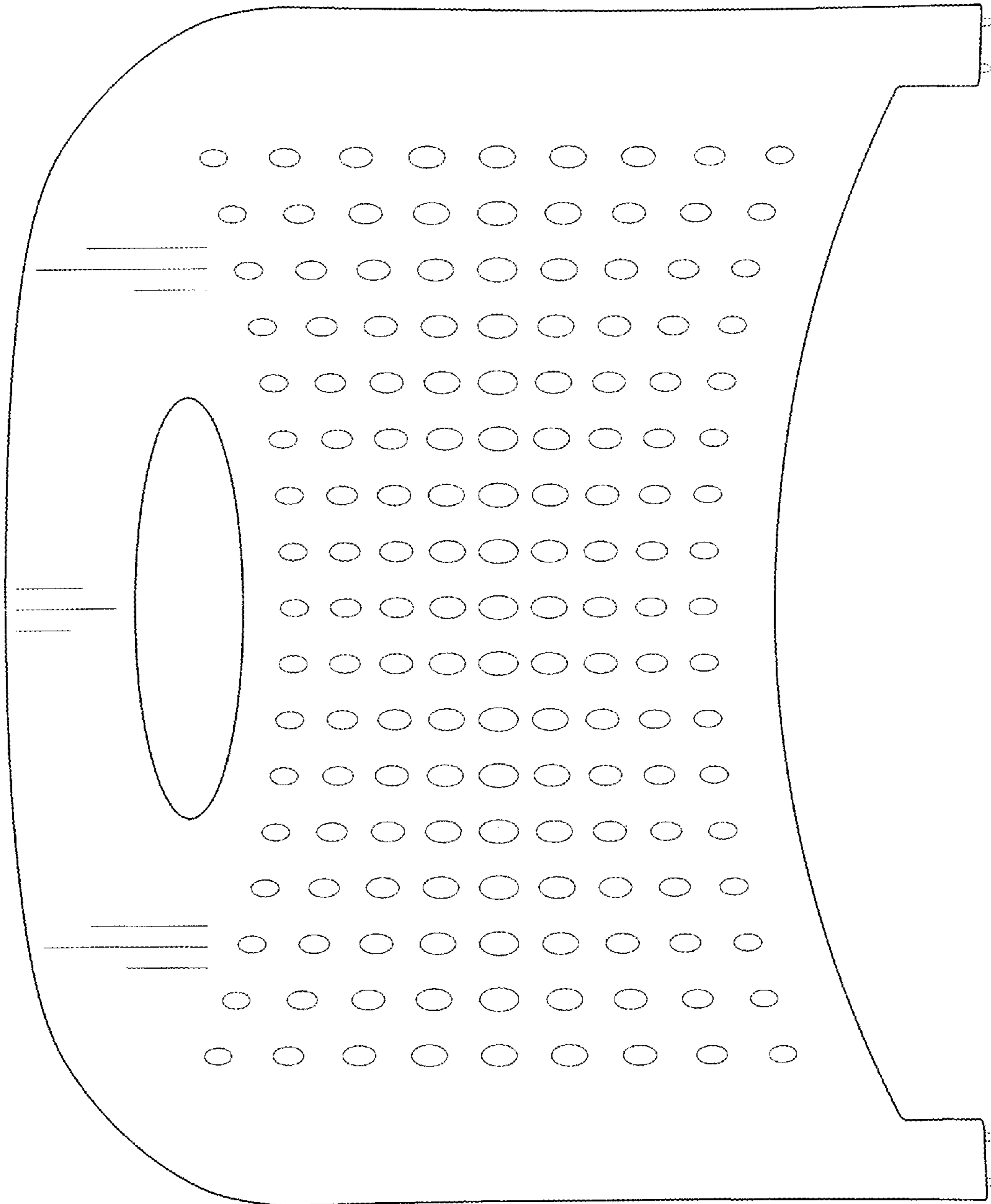

FIG. 3

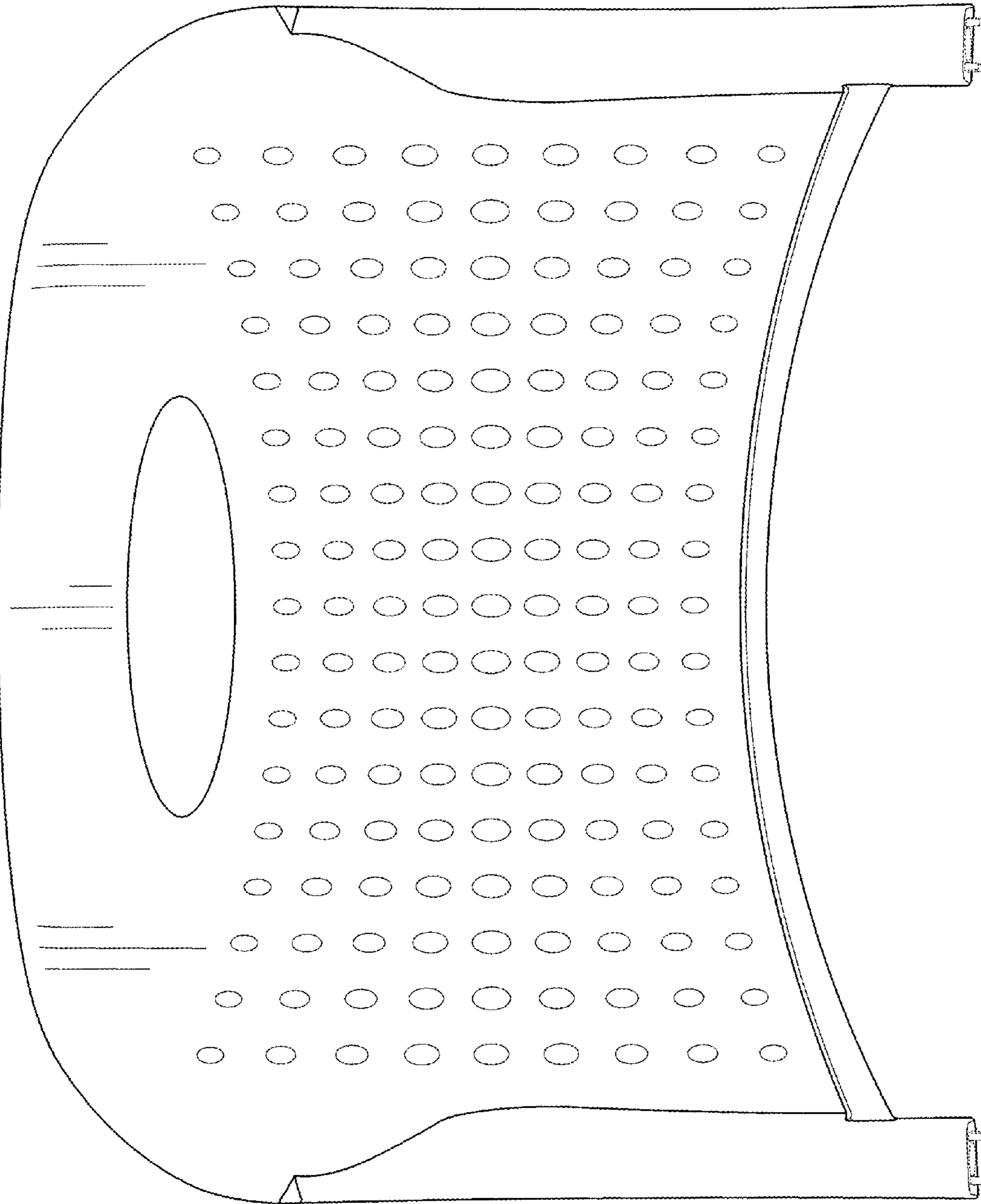

FIG. 5

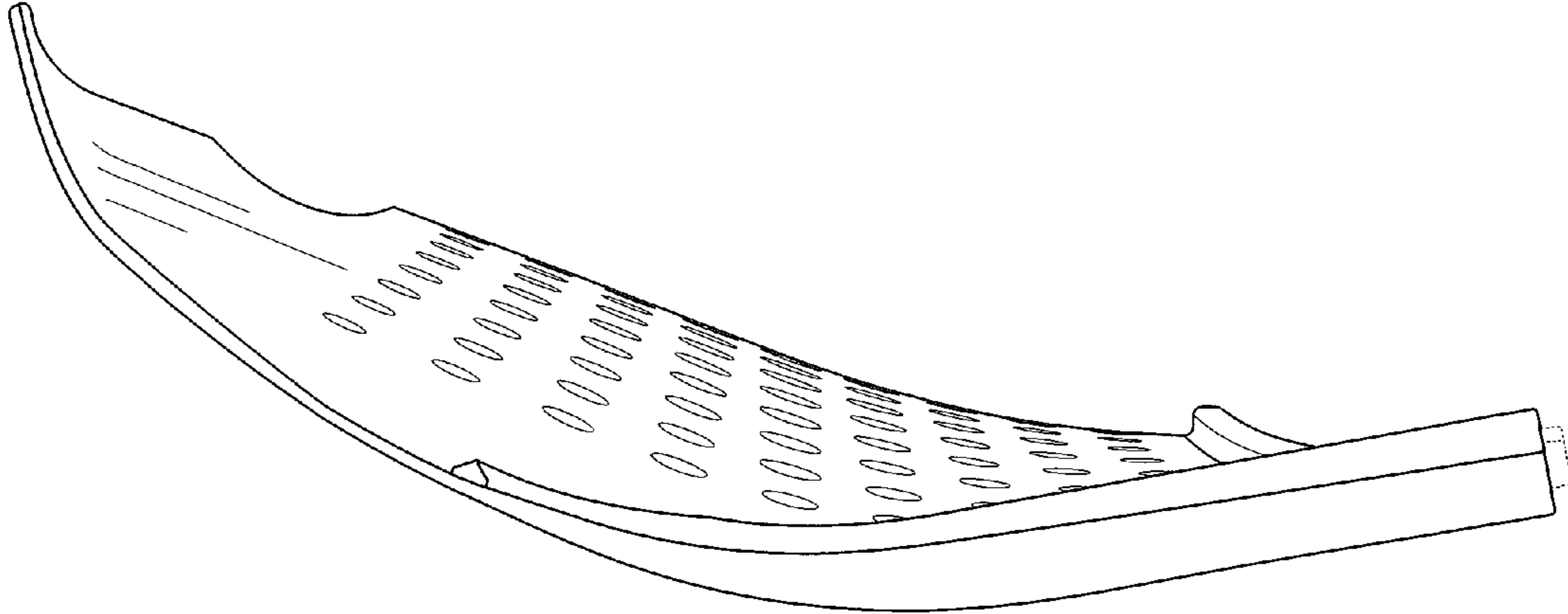

FIG. 4

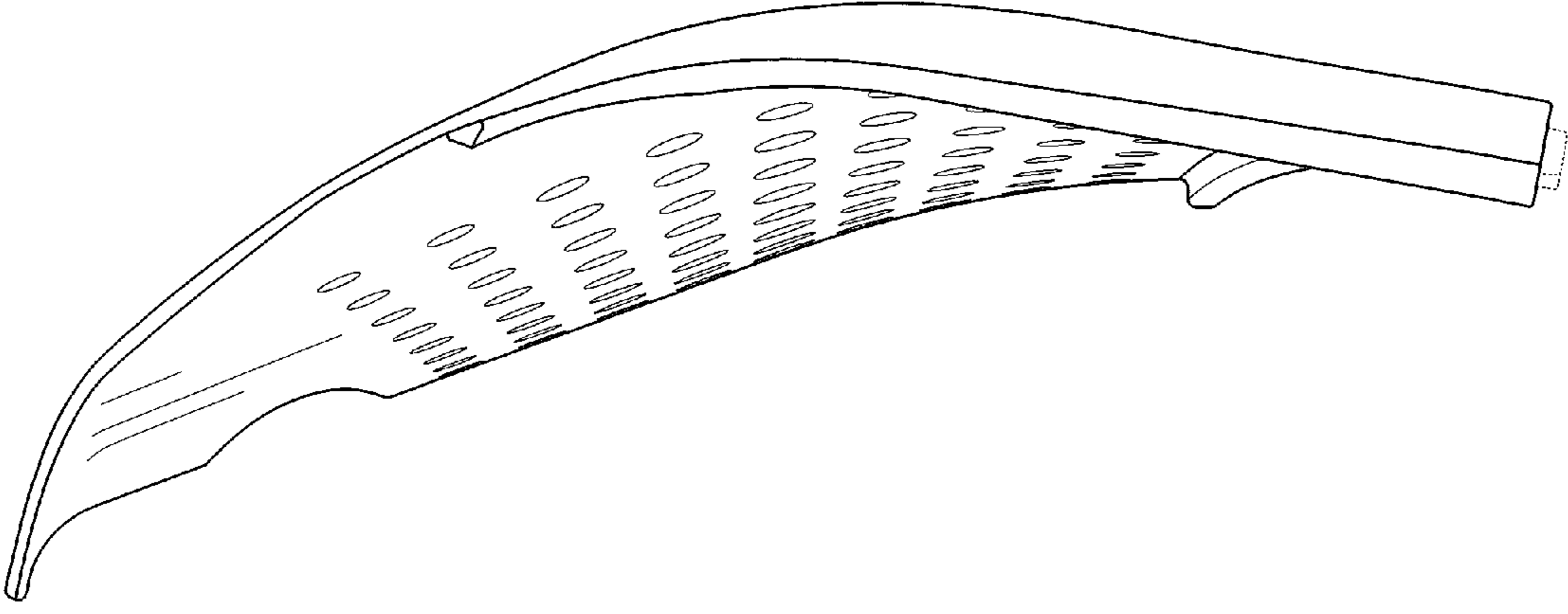

FIG. 6

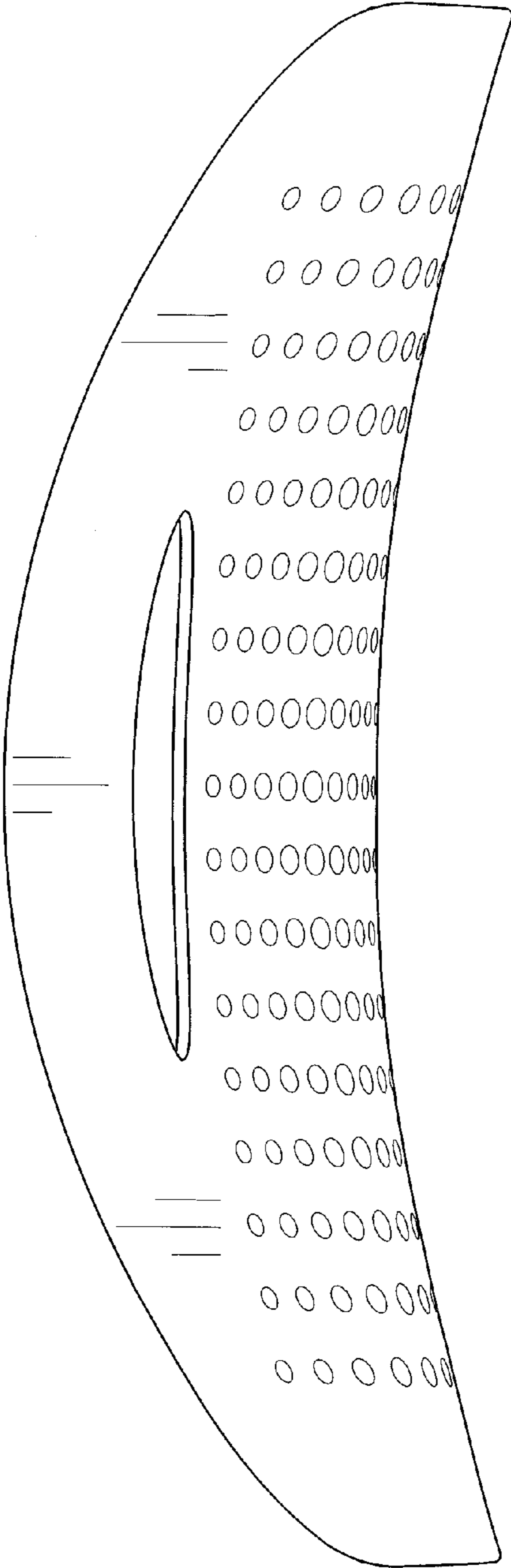

FIG. 7

