

US00D761007S

(12) **United States Design Patent**
Lockwood

(10) **Patent No.:** **US D761,007 S**
(45) **Date of Patent:** **** Jul. 12, 2016**

(54) **ACCESSORY FOR FOOTWEAR**

(71) Applicant: **Mary E. Lockwood**, Arden Hills, MN (US)

(72) Inventor: **Mary E. Lockwood**, Arden Hills, MN (US)

(**) Term: **14 Years**

(21) Appl. No.: **29/492,035**

(22) Filed: **May 28, 2014**

(51) **LOC (10) Cl.** **02-07**

(52) **U.S. Cl.**
USPC **D2/976**

(58) **Field of Classification Search**
USPC D2/896, 901, 946, 969, 972, 973, 977, D2/976
CPC A43B 23/04; A43B 23/07; A43B 3/0078; A43B 3/0084; A43B 3/02; A43B 3/24; A43B 3/242; A43B 3/00; A43B 3/04; A43B 3/06; A43B 3/08; A43B 23/00; A41D 17/00; A41D 17/005; A41D 17/02; A41D 17/04; A41D 13/06; A41D 13/065; A41D 13/08; A41D 13/088; A41D 27/10; A43C 11/02; A43C 19/00; A41B 7/00; A41B 7/10; A41B 7/12

See application file for complete search history.

(56) **References Cited**

U.S. PATENT DOCUMENTS

D46,602 S	10/1914	Morse	
D59,047 S	9/1921	Tweedie	
D60,074 S	12/1921	Tweedie	
D60,075 S *	12/1921	Tweedie	D2/901
D62,925 S	8/1923	Thomas	
2,640,281 A	6/1953	Murphy	
3,338,237 A *	8/1967	Sconce	A61F 5/05816 128/DIG. 20
4,766,682 A *	8/1988	Malloy, III	A43B 3/0078 36/132

(Continued)

OTHER PUBLICATIONS

Bentis Companies, LLC, Minneapolis, Minnesota, US, "Kikker Kiks" brochure, Feb. 2012.

Primary Examiner — Elizabeth J Oswecki

(74) *Attorney, Agent, or Firm* — Walter K. Roloff

(57) **CLAIM**

The ornamental design for an accessory for footwear, as shown and described.

DESCRIPTION

A portion of the disclosure of this patent document contains material to which a claim for copyright is made. The copyright owner has no objection to the facsimile reproduction by anyone of the patent document or the patent disclosure as it appears in the Patent and Trademark Office patent file or records; but the owner reserves all other copyrights whatsoever, worldwide.

FIG. 1 is a front perspective view of a first embodiment of an accessory for footwear, shown in a used condition with a foot shown in broken lines, showing my new design;

FIG. 2 is a front perspective view thereof;

FIG. 3 is a front view thereof;

FIG. 4 is a rear view thereof;

FIG. 5 is a left side view thereof;

FIG. 6 is a right side view thereof;

FIG. 7 is a top view thereof;

FIG. 8 is a bottom view thereof;

FIG. 9 is a front perspective view of a second embodiment of an accessory for footwear, shown in a used condition with a foot and bow shown in broken lines, showing my new design;

FIG. 10 is a front perspective view thereof, shown in an unused condition without a foot;

FIG. 11 is a front view thereof;

FIG. 12 is a rear view thereof;

FIG. 13 is a left side view thereof;

FIG. 14 is a right side view thereof;

FIG. 15 is a top view thereof; and,

FIG. 16 is a bottom view thereof.

The broken lines shown in the drawings represent portions of the accessory for footwear that form no part of the claimed design.

1 Claim, 10 Drawing Sheets

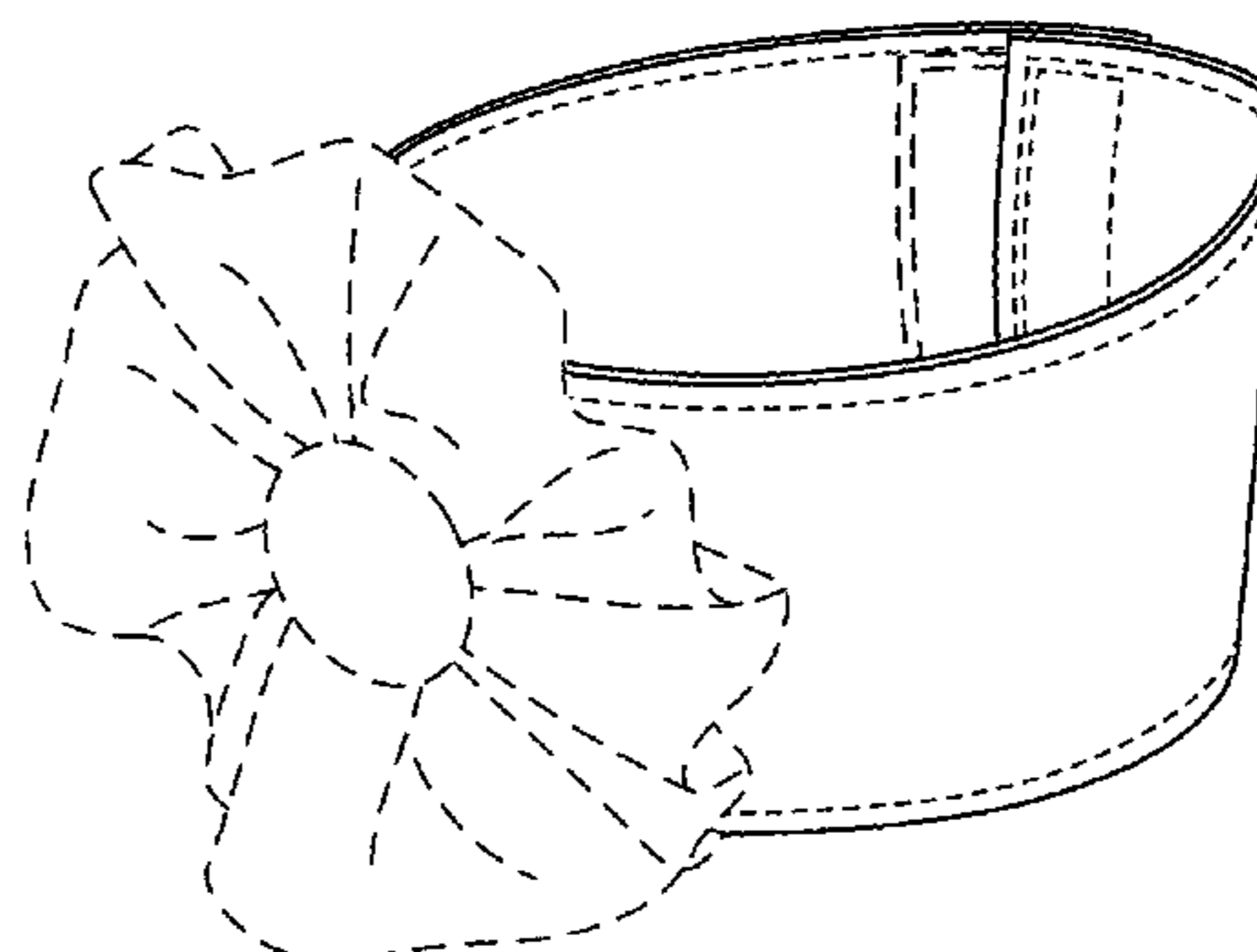
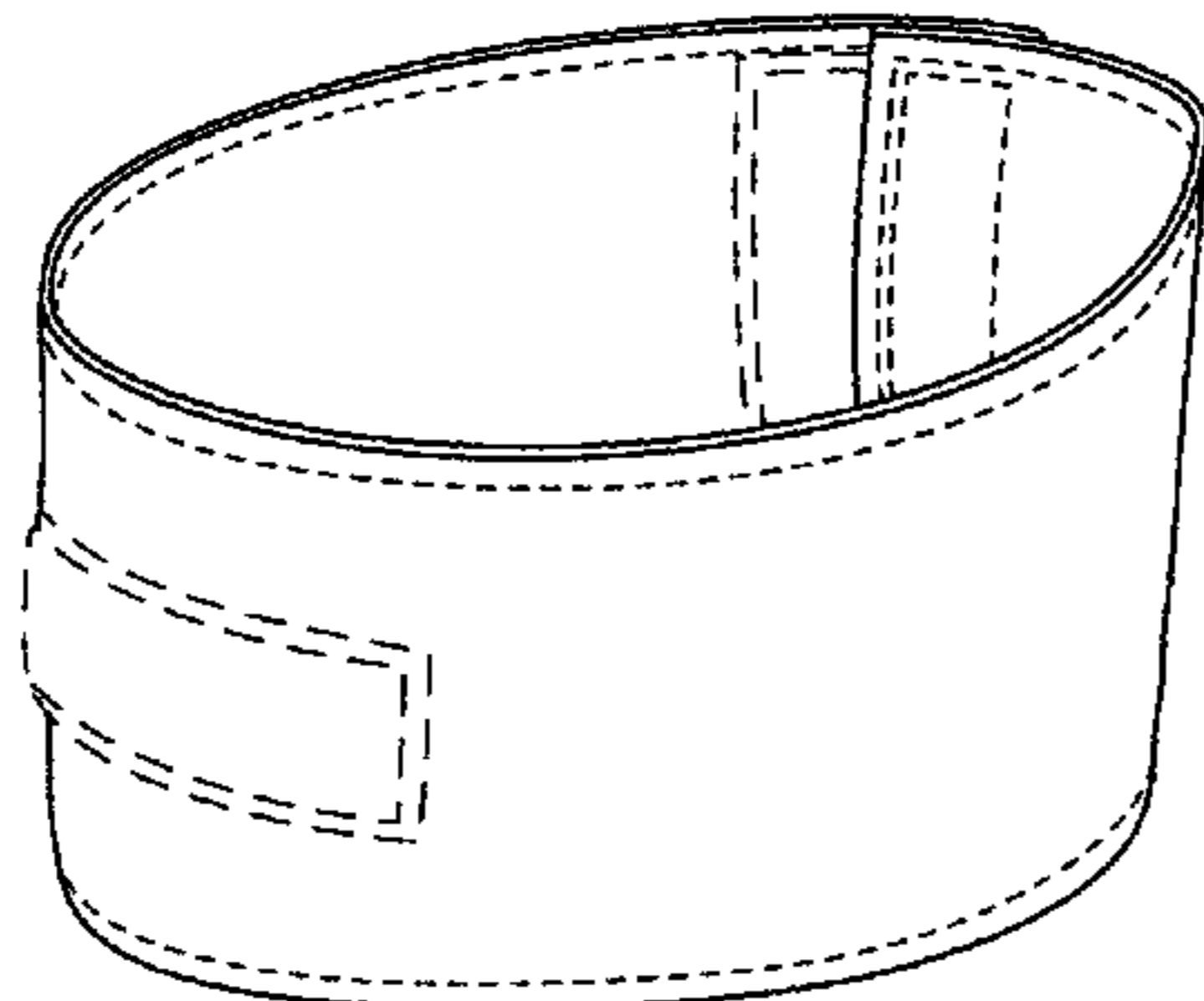

(56)

References Cited

U.S. PATENT DOCUMENTS

D374,335 S *	10/1996	Grimes	D2/909	D598,642 S	8/2009	Plumert	
D376,472 S *	12/1996	Hatfield	D2/976	D599,981 S *	9/2009	Kim	D2/901
D385,102 S *	10/1997	Avar	D2/946	D599,982 S *	9/2009	Kim	D2/901
D403,493 S *	1/1999	McKinley	D2/900	D604,037 S *	11/2009	Feller	D2/946
D425,996 S *	5/2000	Owen, Jr.	D24/189	D625,085 S *	10/2010	Frase	D2/901
D434,214 S	11/2000	Burns		D636,154 S *	4/2011	Teichert	D2/901
D453,413 S *	2/2002	Tsujino	D2/978	D654,671 S *	2/2012	Coleman	D2/946
D460,612 S	7/2002	Duffy		D664,332 S	7/2012	Garcia Mira	
D470,304 S *	2/2003	Berg	D2/978	D711,080 S *	8/2014	Hollister	D2/946
D504,727 S *	5/2005	Schirmacher	D24/190	D715,532 S *	10/2014	Pappas	D2/976
D505,777 S *	6/2005	Dunlap	D2/901	D725,344 S *	3/2015	Rich	D2/624
D518,947 S *	4/2006	Choi	D2/976	D734,595 S *	7/2015	Brown	D2/901
				D736,513 S *	8/2015	McAfee	D2/976
				D743,160 S *	11/2015	Wise	D2/976
				D744,226 S *	12/2015	Wise	D2/976

* cited by examiner

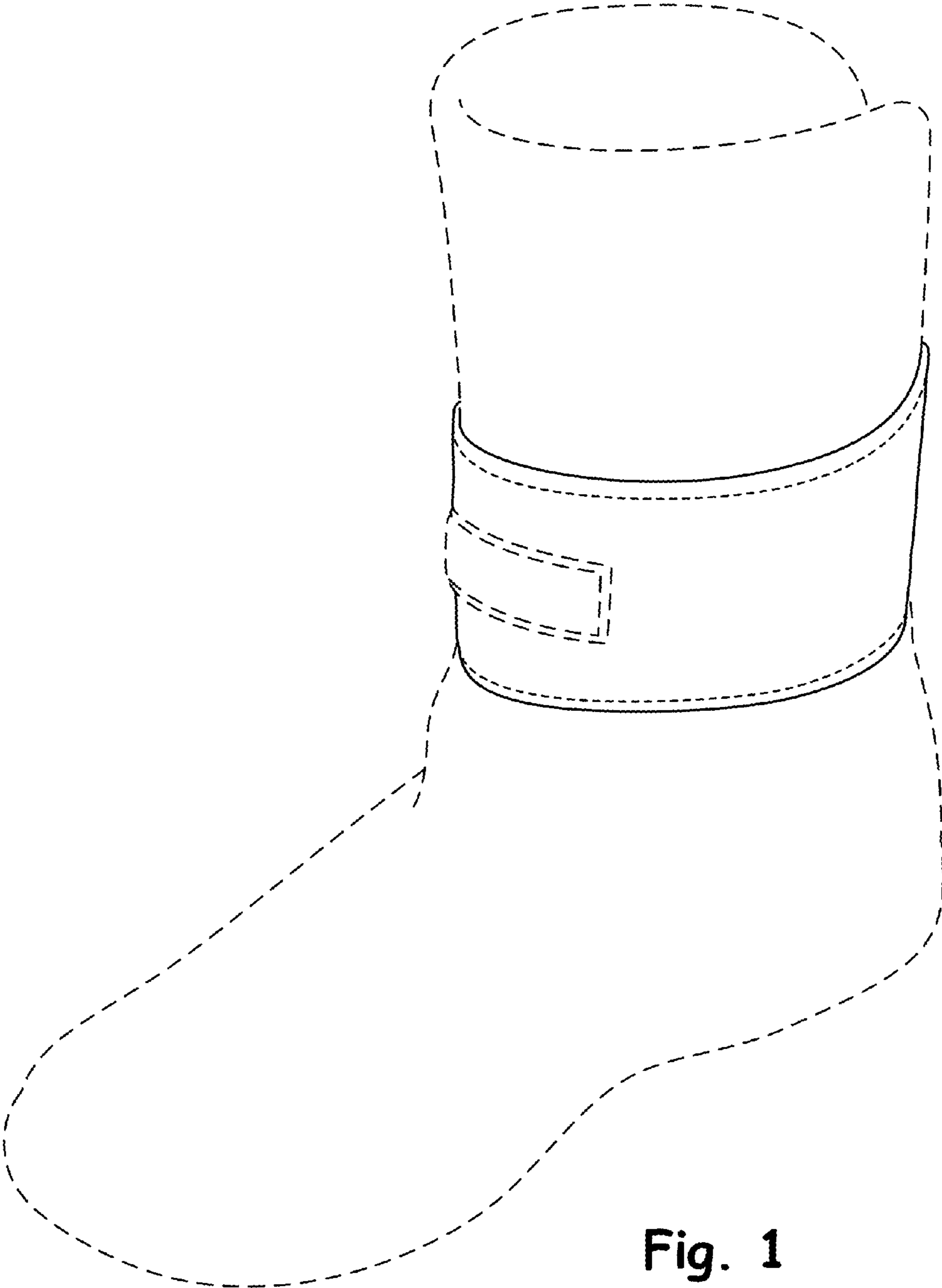

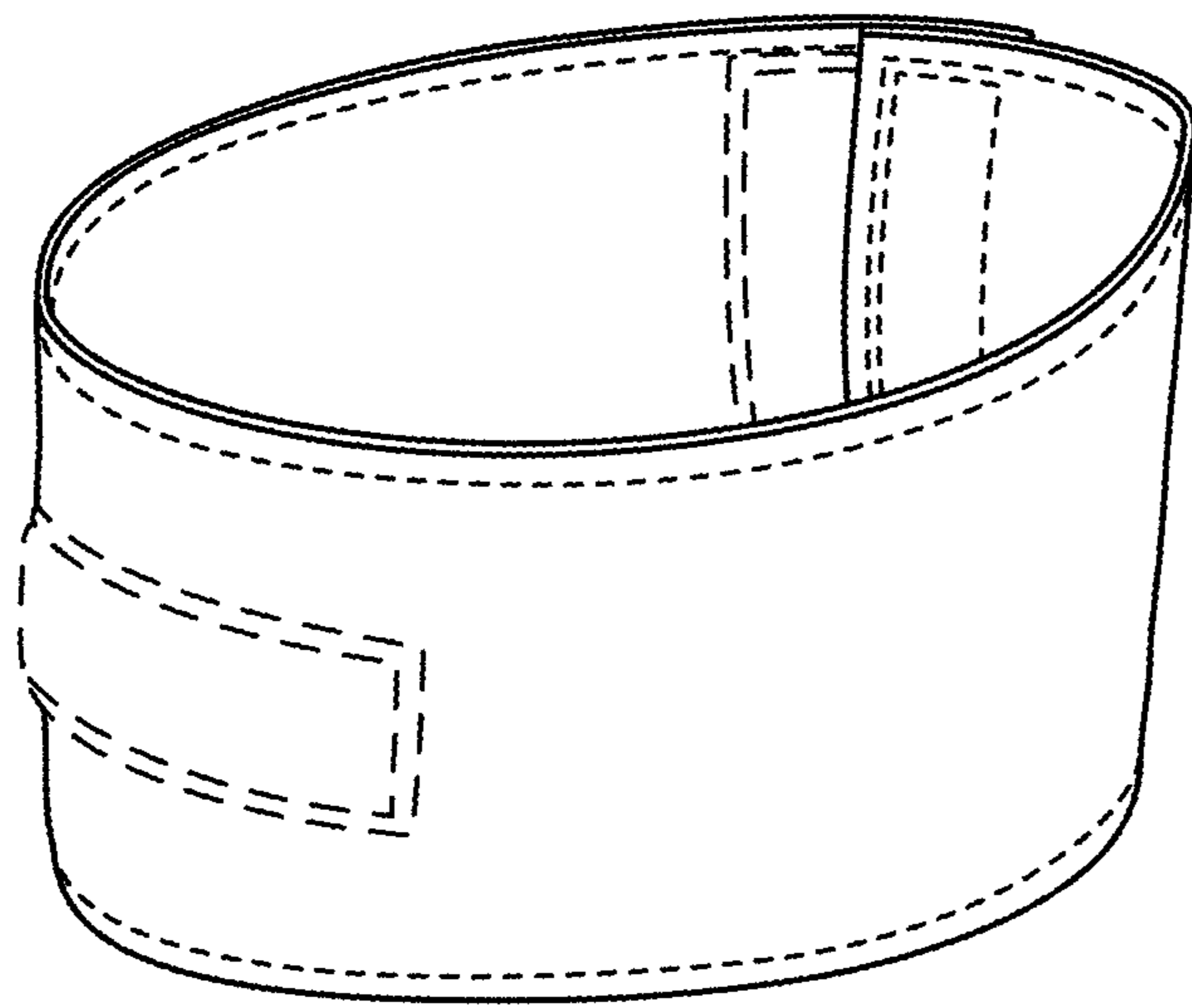

Fig. 2

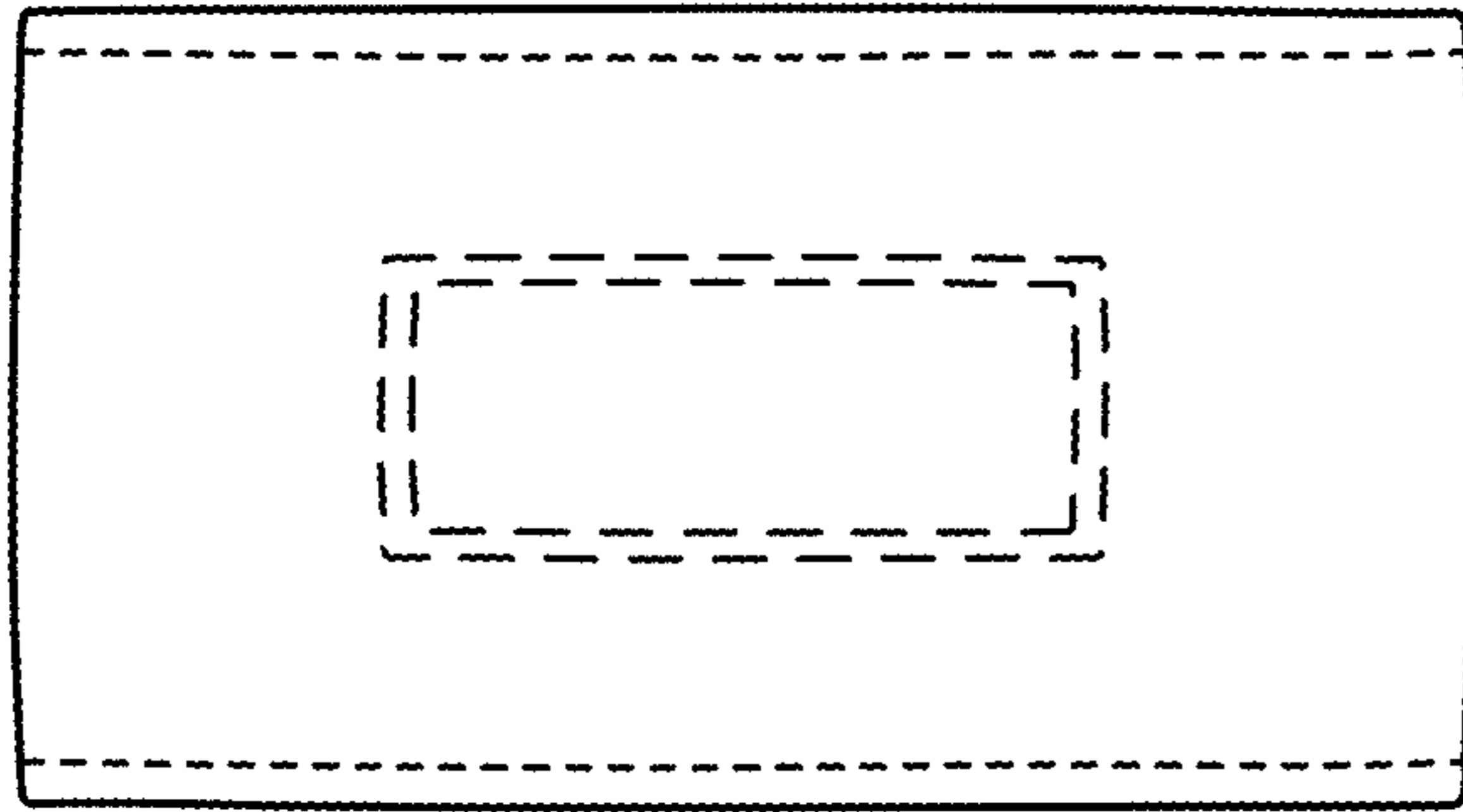

Fig. 3

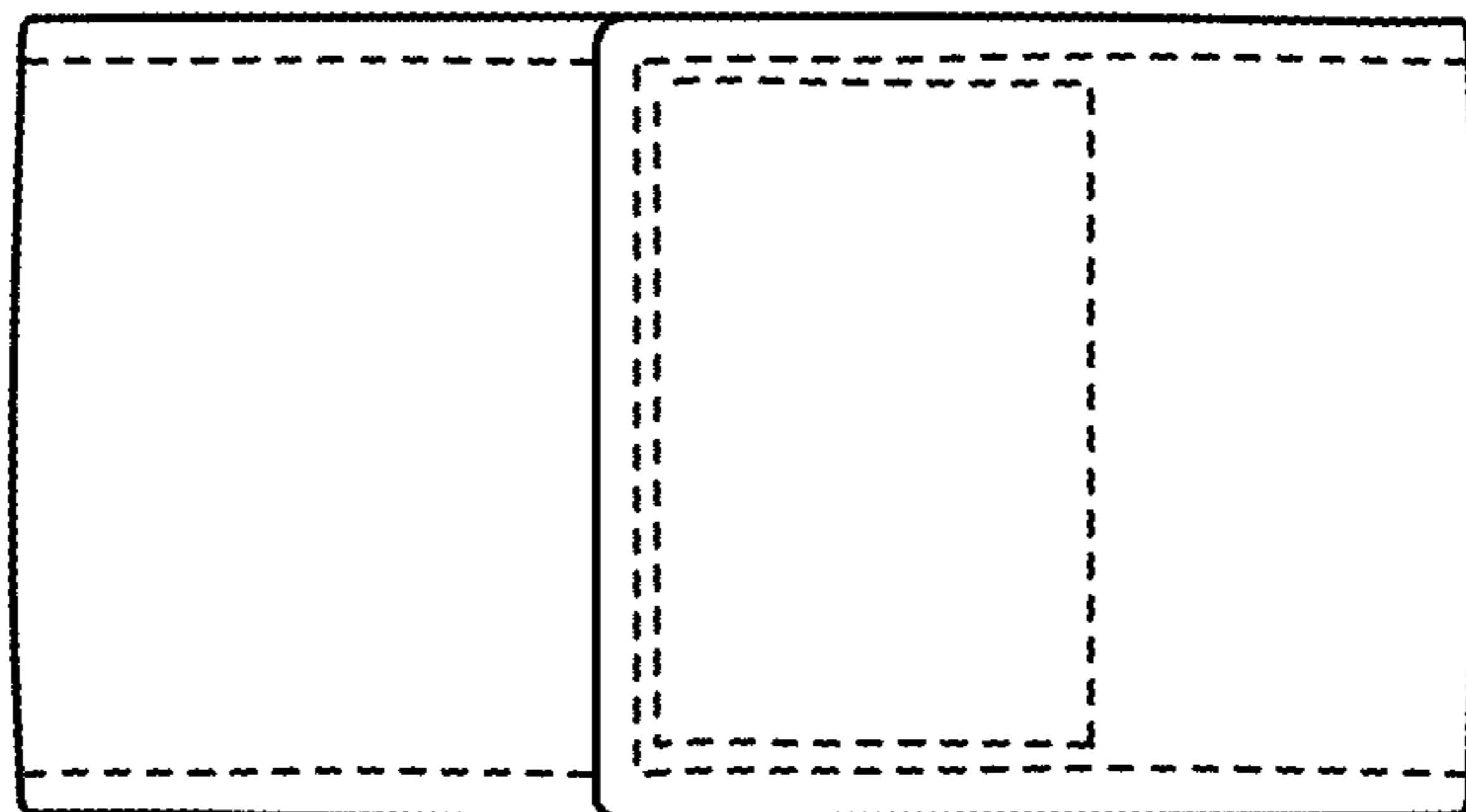

Fig. 4

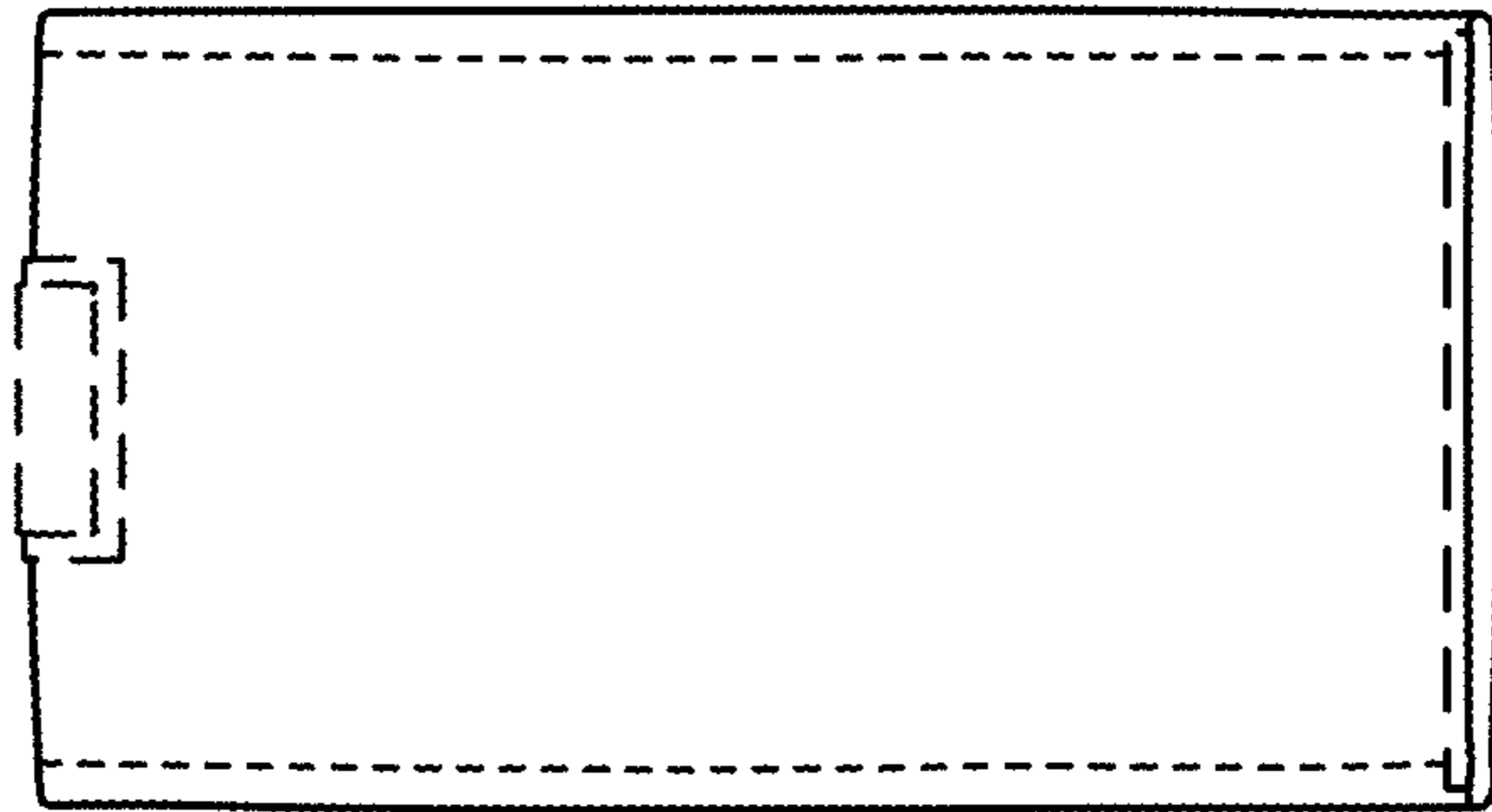

Fig. 5

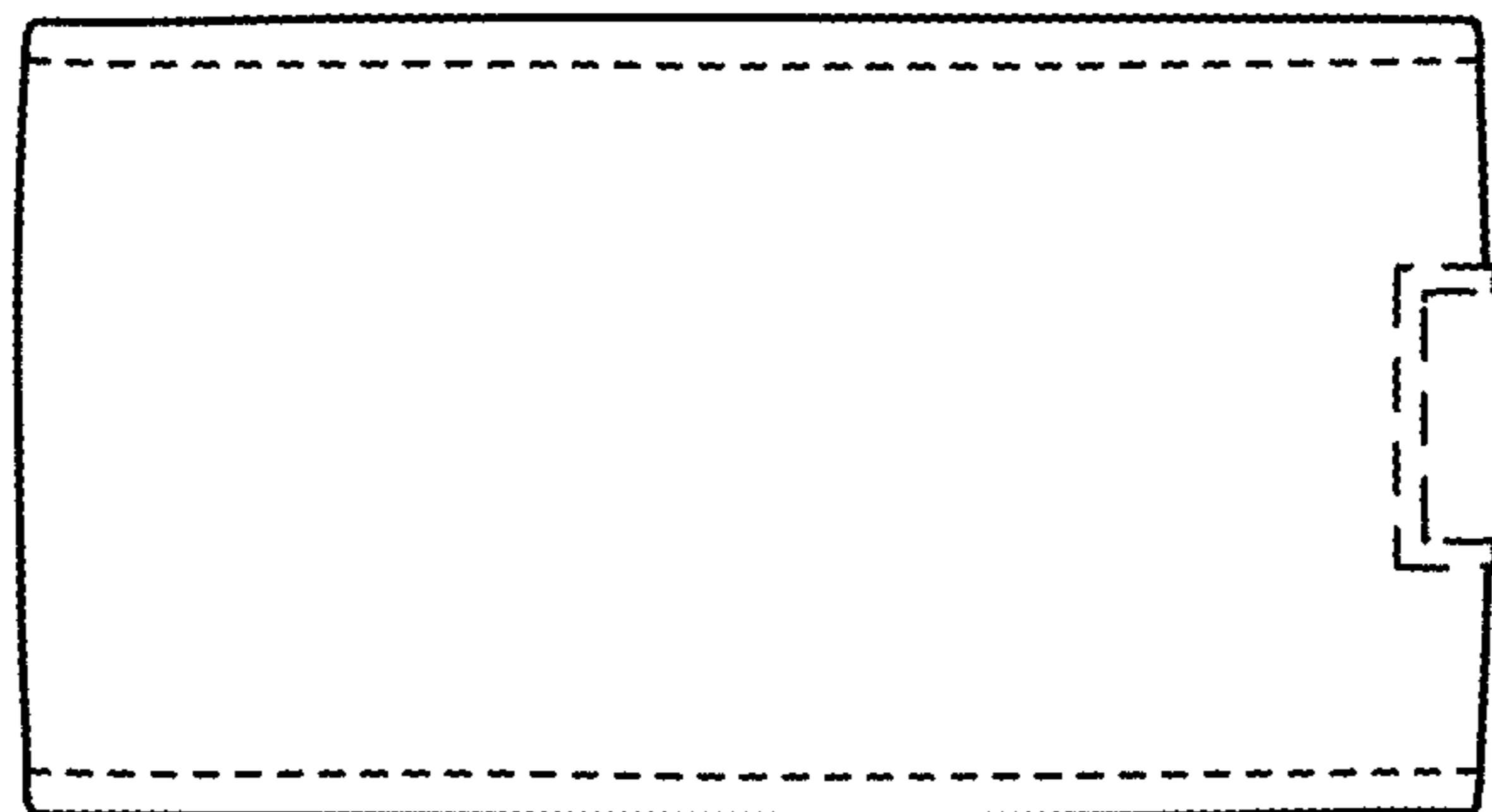

Fig. 6

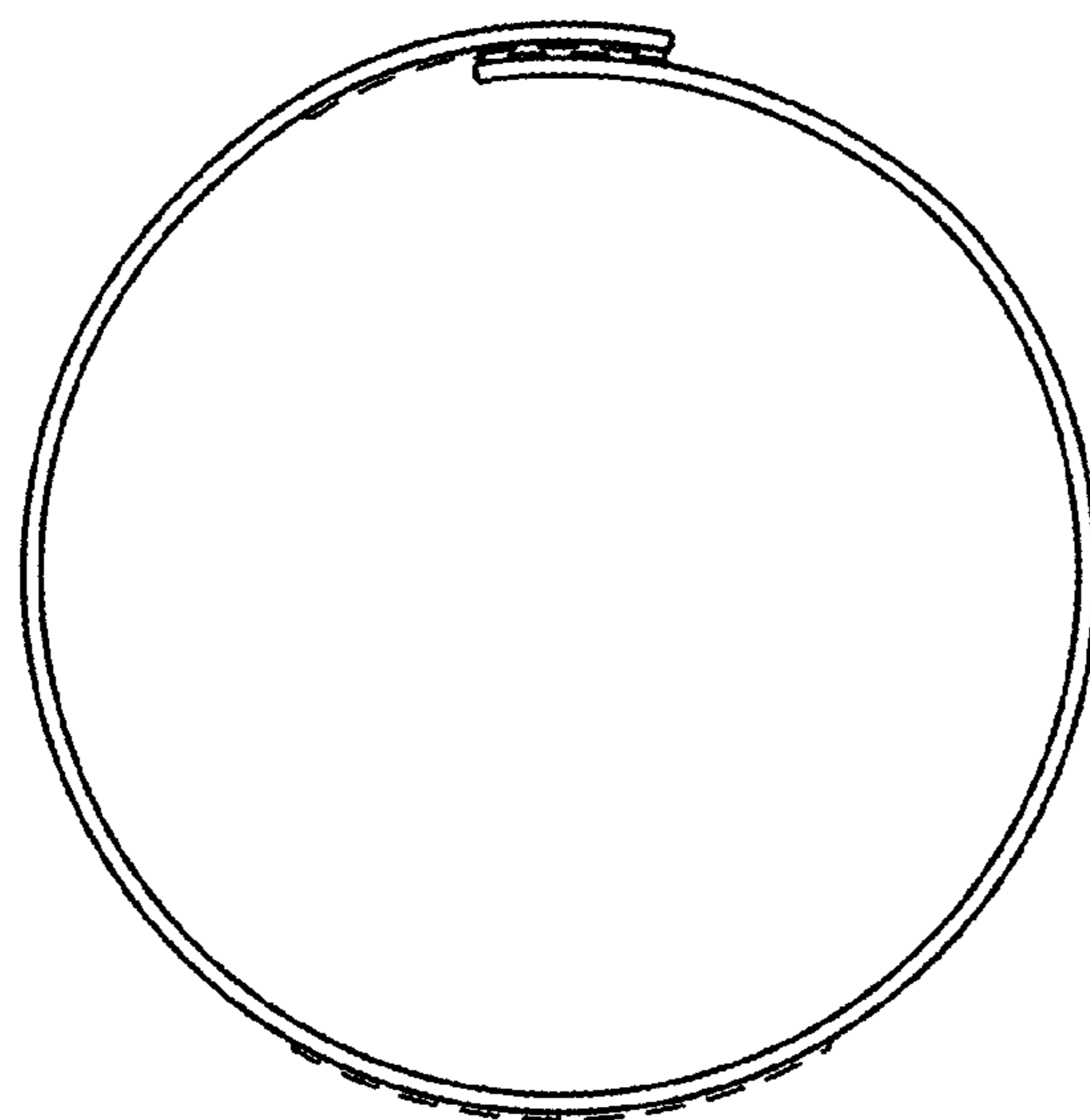

Fig. 7

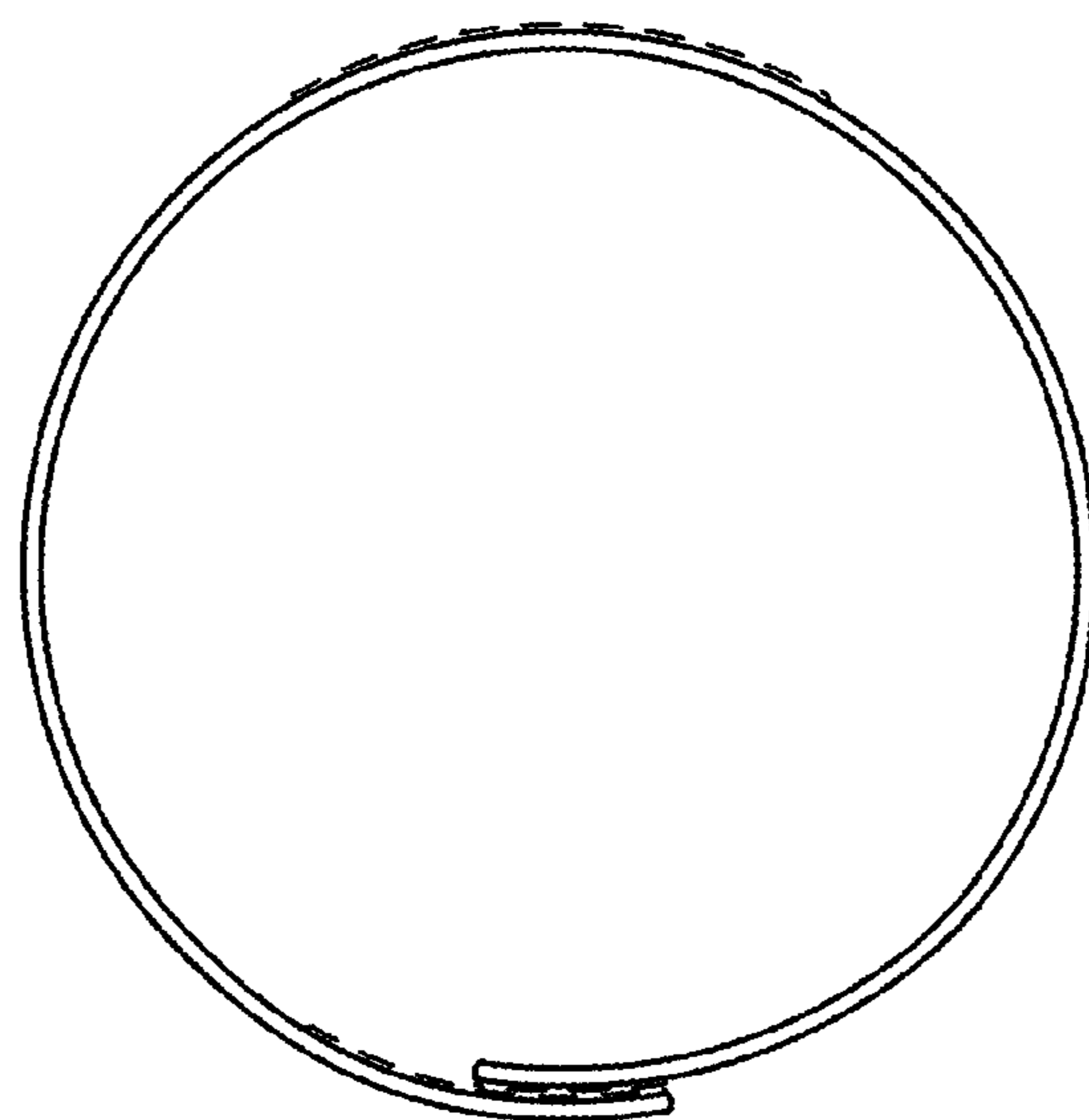

Fig. 8

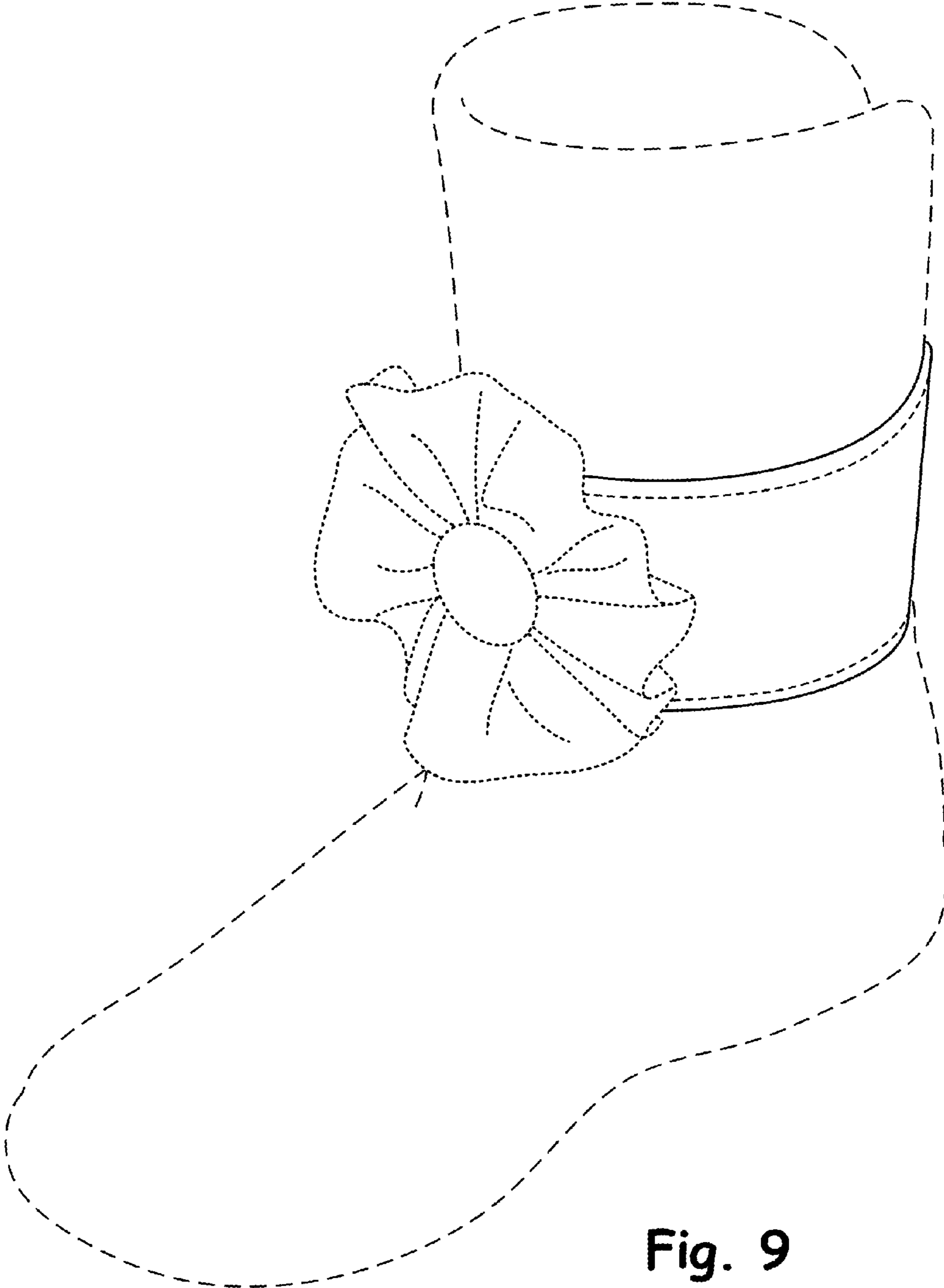

Fig. 9

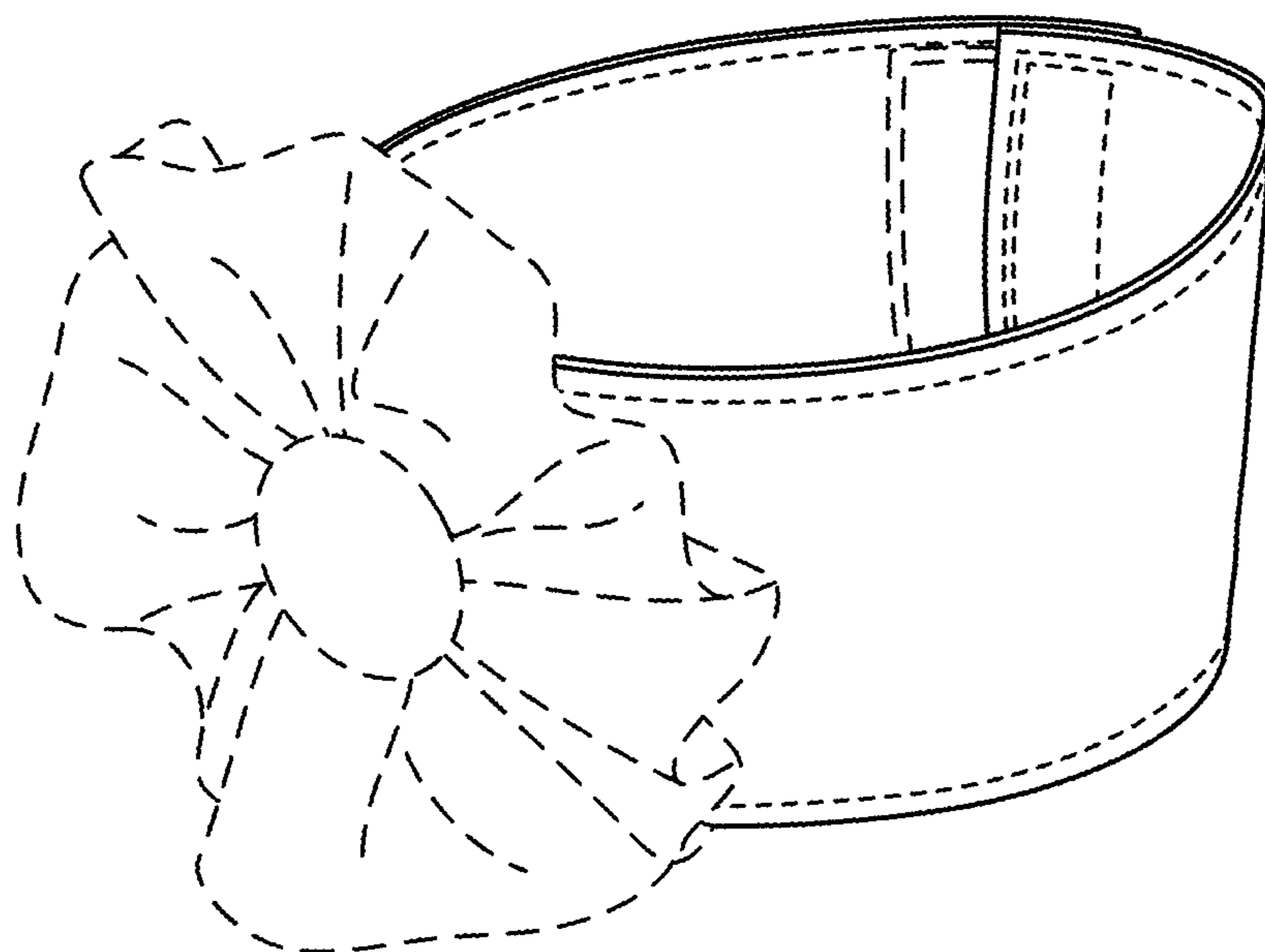

Fig. 10

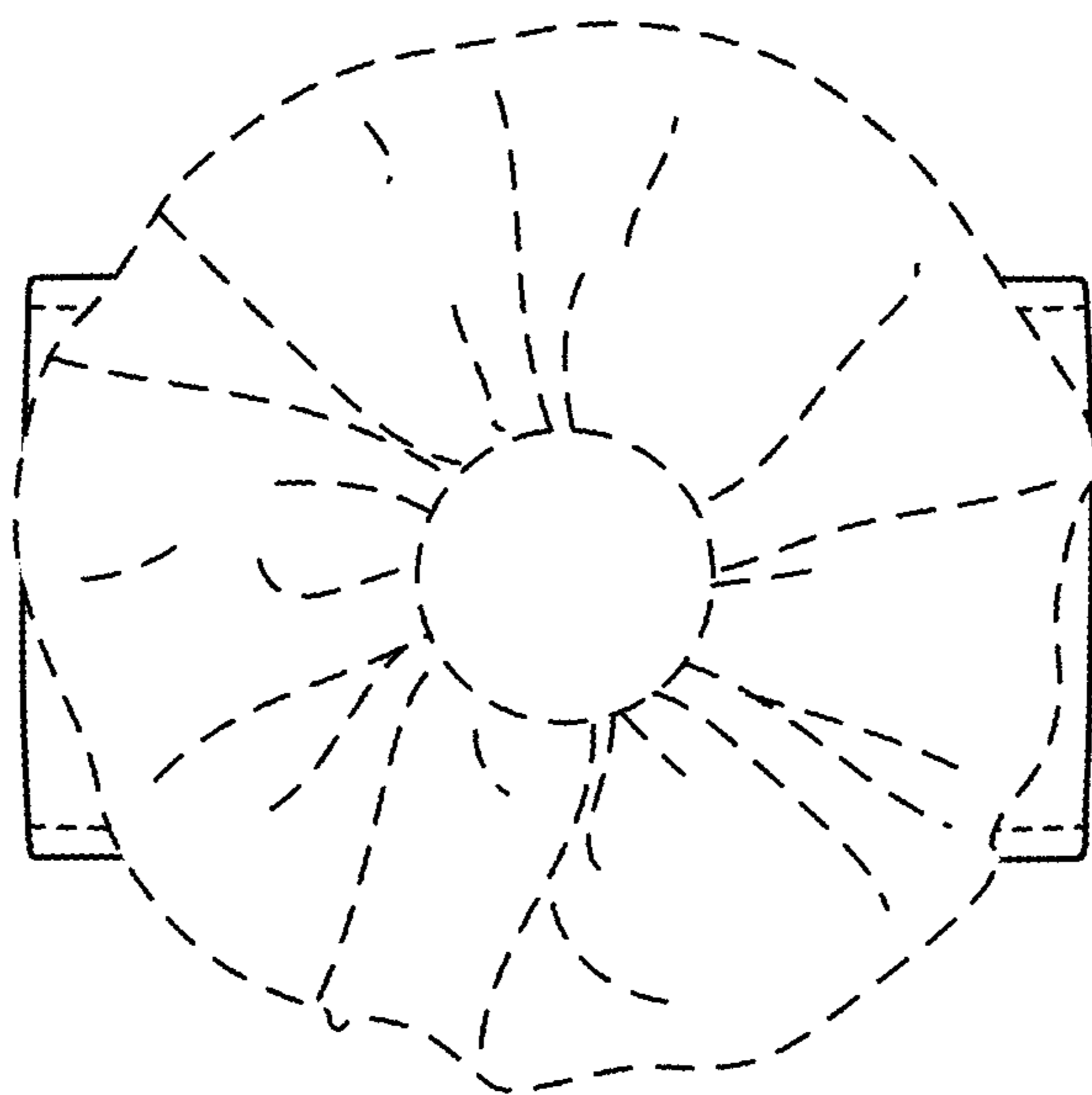

Fig. 11

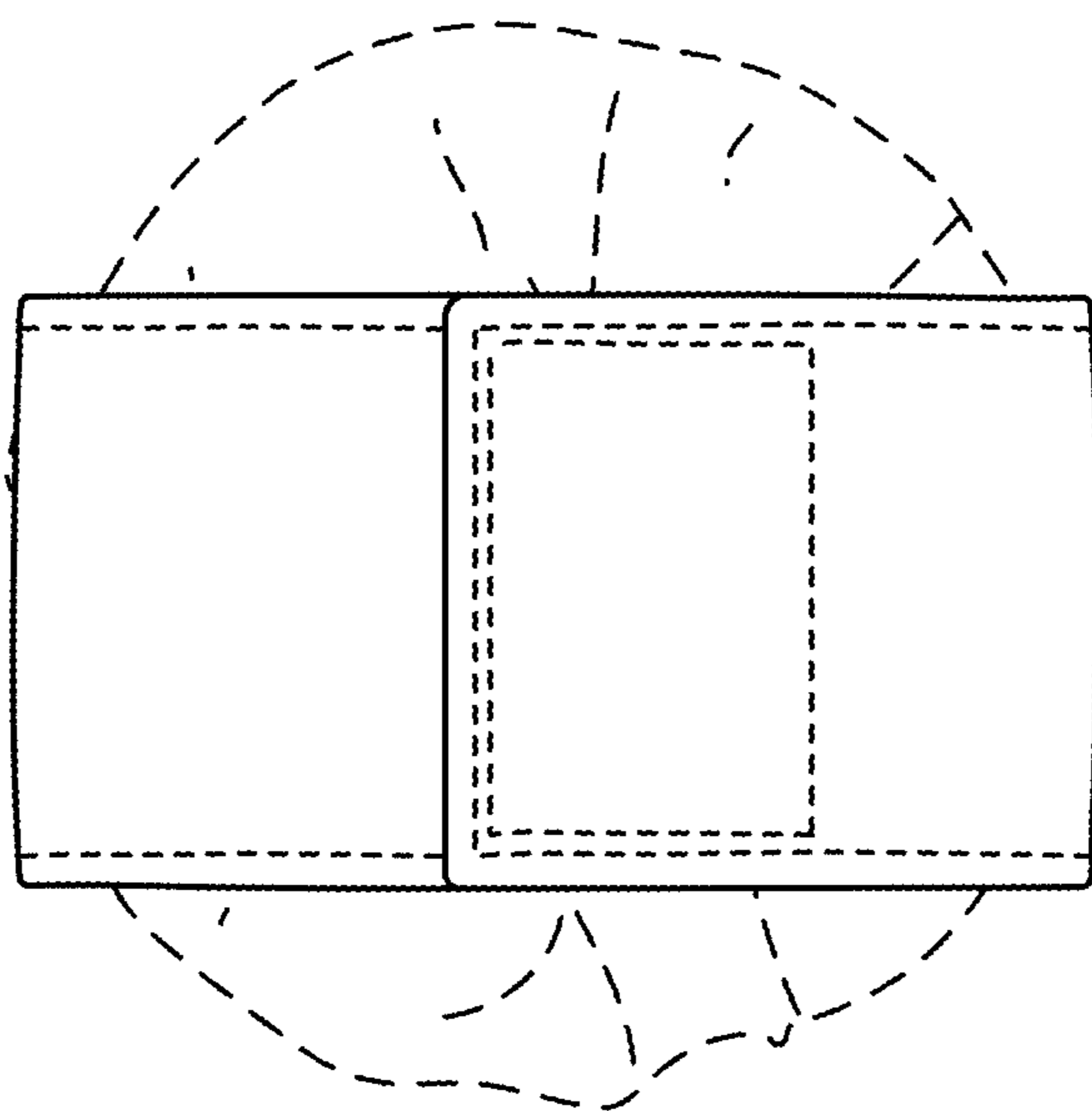

Fig. 12

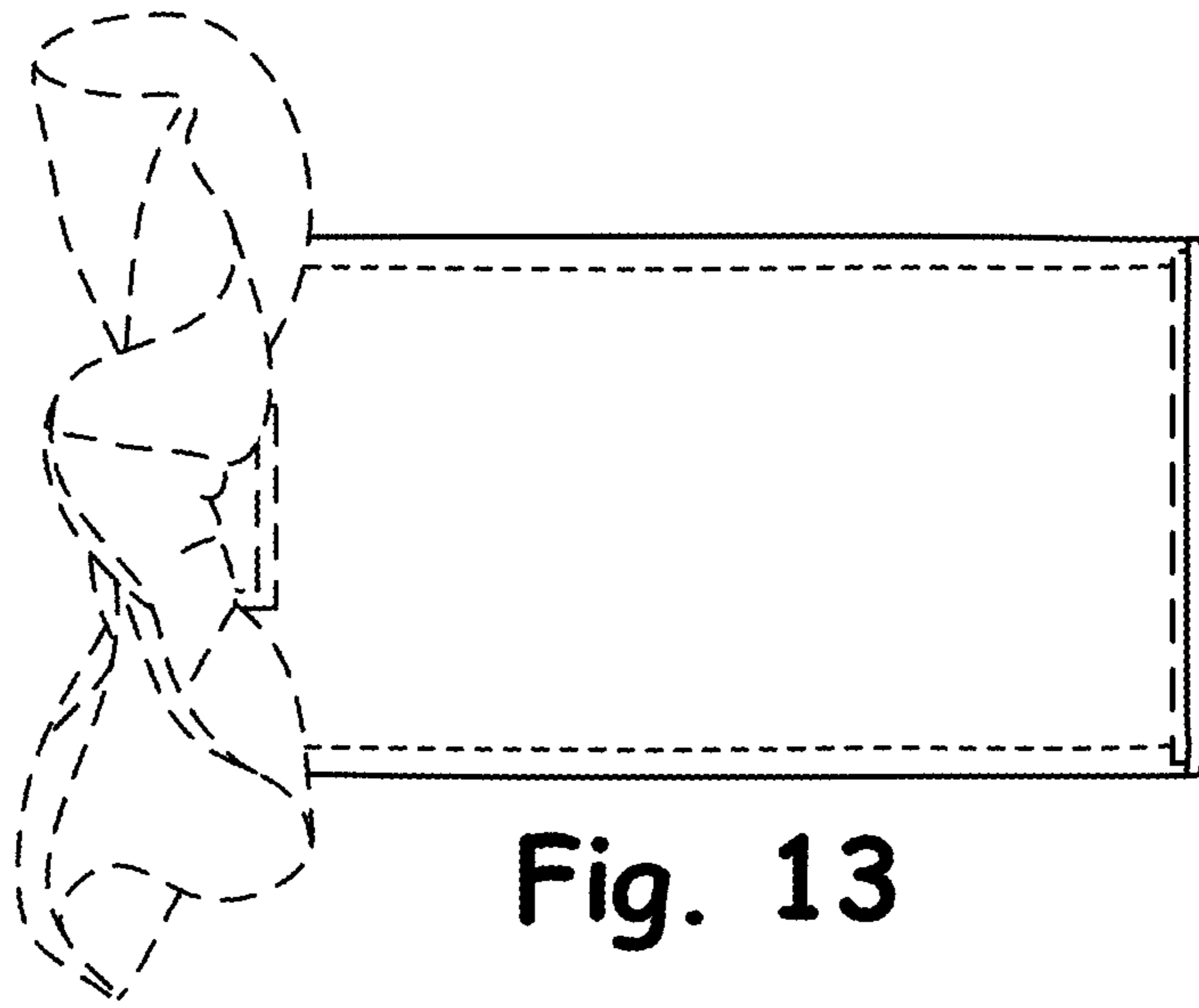

Fig. 13

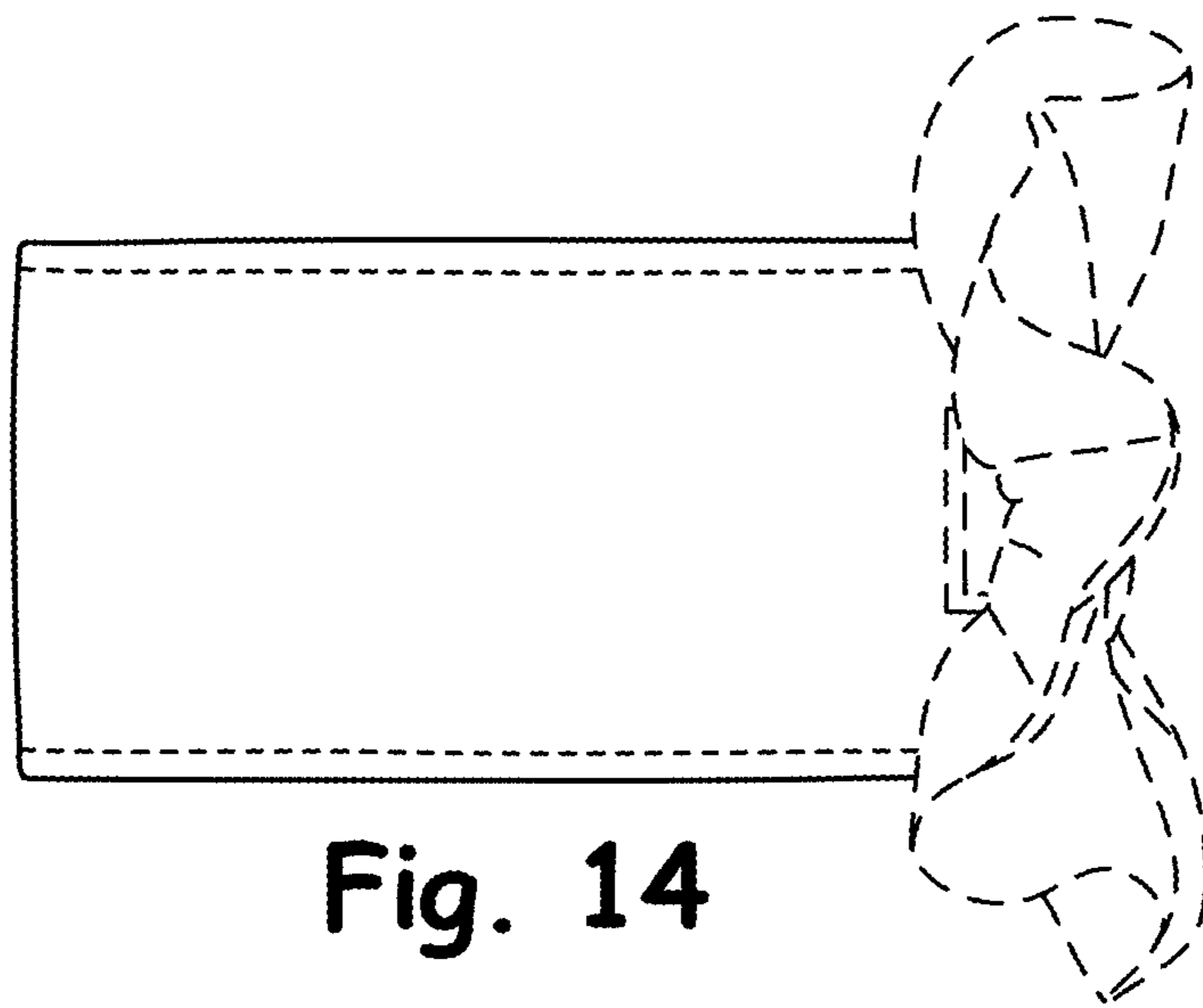

Fig. 14

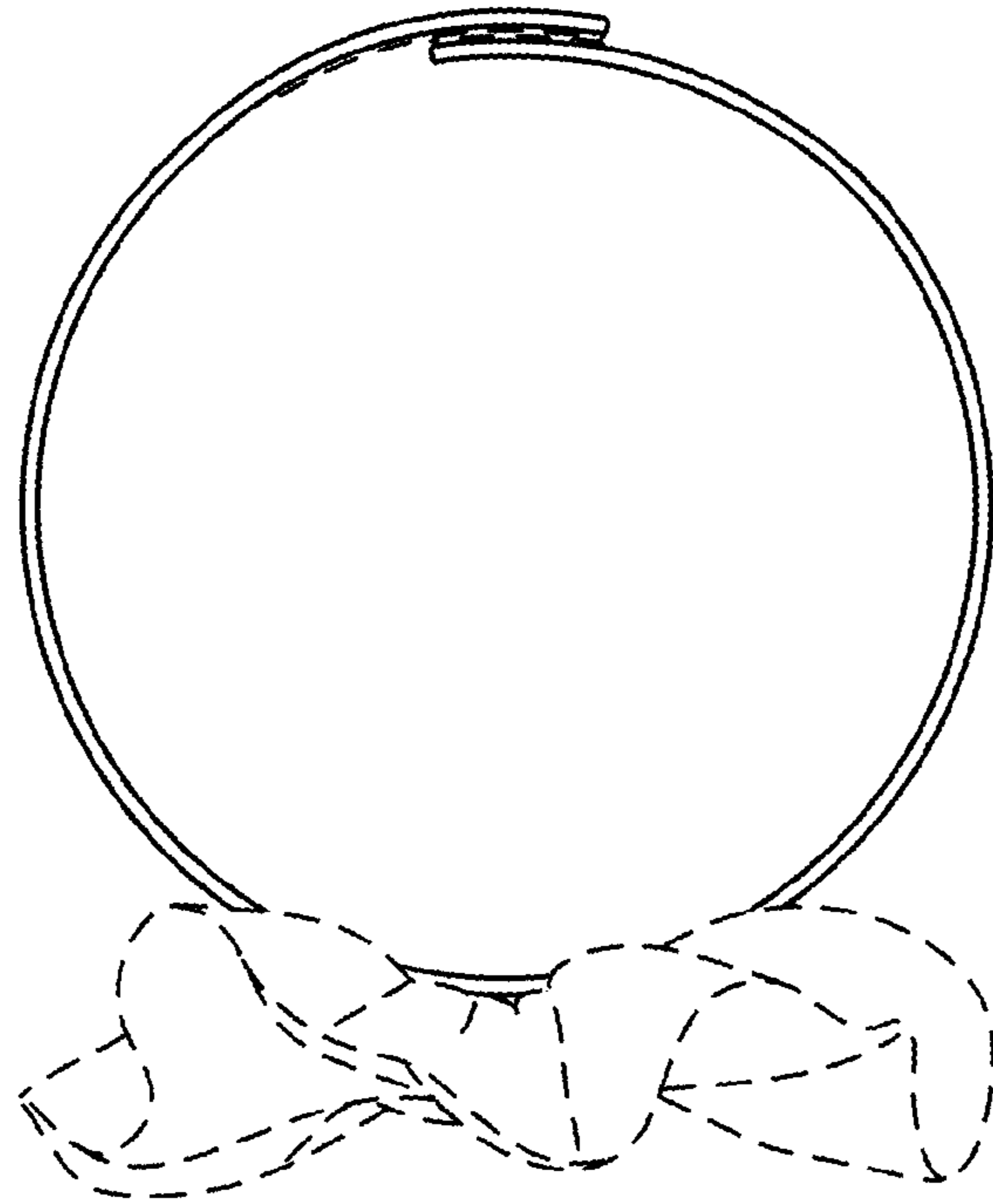

Fig. 15

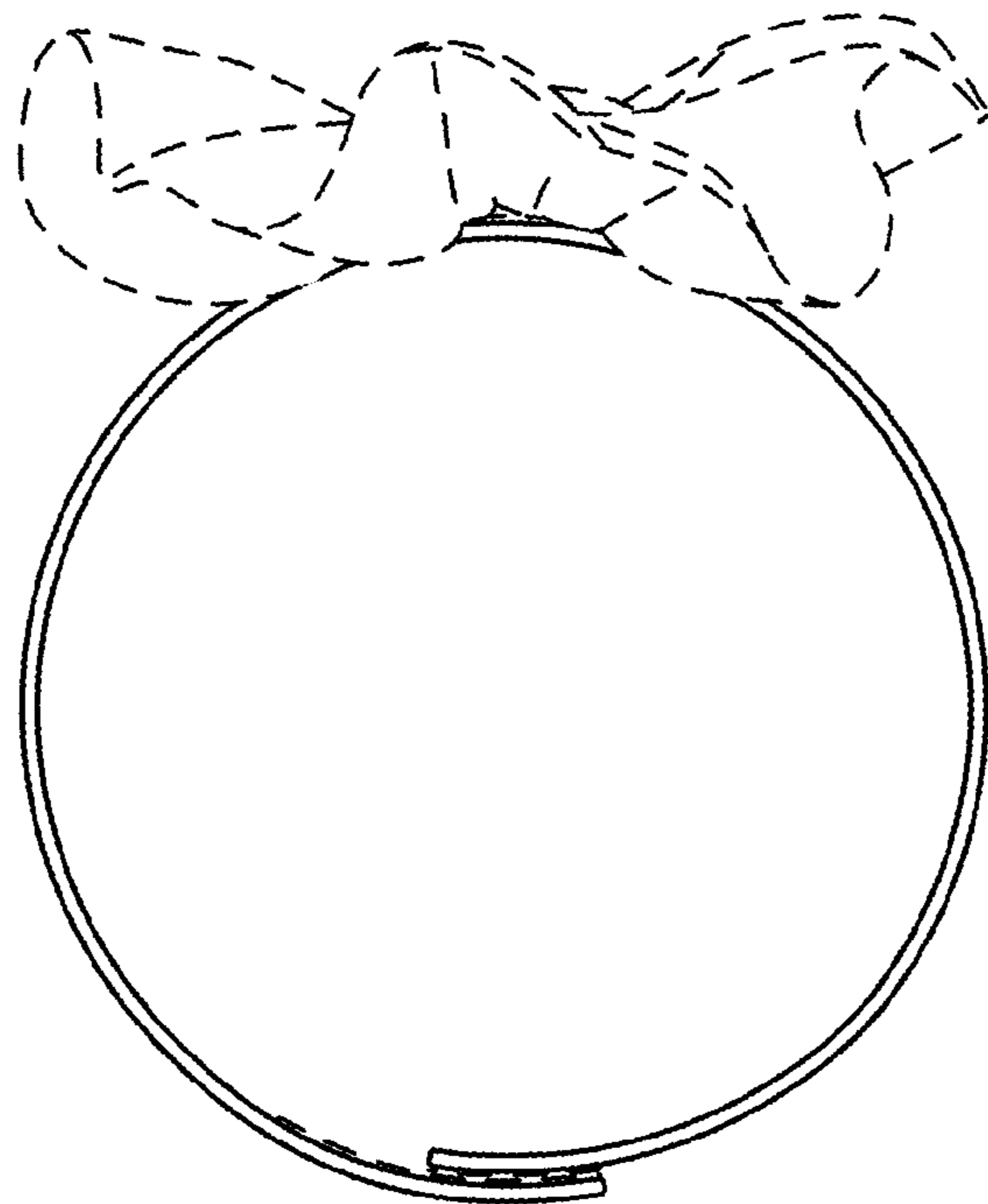

Fig. 16