



US00D760912S

(12) **United States Design Patent**
Sedic

(10) **Patent No.:** **US D760,912 S**
(45) **Date of Patent:** **** Jul. 5, 2016**

(54) **ACNE PEN**

(71) Applicant: **Filip Sedic**, Shanghai (CN)

(72) Inventor: **Filip Sedic**, Shanghai (CN)

(**) Term: **15 Years**

(21) Appl. No.: **29/531,558**

(22) Filed: **Jun. 26, 2015**

(51) **LOC (10) Cl.** **28-03**

(52) **U.S. Cl.**
USPC **D24/209**

(58) **Field of Classification Search**

USPC D24/107, 186, 158, 231, 200, 209, 210;
D26/29, 37, 39, 93, 104; D28/9
CPC A61N 5/0616; A61N 5/0624; A61N
2005/0652; A61N 2005/0654; A61N
2005/0642; A61N 2005/0644; A61N
2005/0636; A61N 2005/0626; A61N
2005/0627; A61B 2018/00452; A61B
2018/1807

See application file for complete search history.

(56) **References Cited**

U.S. PATENT DOCUMENTS

5,464,436 A * 11/1995 Smith A61N 5/0616
606/13
D428,503 S * 7/2000 Rann D26/46
D519,214 S * 4/2006 Lansohn D24/210
D576,284 S * 9/2008 Kennedy D24/209
D576,285 S * 9/2008 Kennedy D24/209
D577,814 S * 9/2008 Seki D24/107
D585,997 S * 2/2009 Adam D24/210
D612,510 S * 3/2010 Byle D24/210
D621,949 S * 8/2010 Seki D24/209

D707,839 S * 6/2014 Bradley D24/209
2008/0091179 A1 * 4/2008 Durkin A61B 18/203
606/9
2010/0069898 A1 * 3/2010 O'Neil A61B 18/203
606/9

* cited by examiner

Primary Examiner — Anhdao Doan

(74) *Attorney, Agent, or Firm* — Fenwick & West LLP

(57) **CLAIM**

I claim the ornamental design for an acne pen, as shown and described.

DESCRIPTION

FIG. 1 is a perspective view of a first embodiment of an acne pen.

FIG. 2 is a front view of the first embodiment of the acne pen.

FIG. 3 is a back view of the first embodiment of the acne pen.

FIG. 4 is a left view of the first embodiment of the acne pen.

FIG. 5 is a right view of the first embodiment of the acne pen.

FIG. 6 is a top view of the first embodiment of the acne pen.

FIG. 7 is a bottom view of the first embodiment of the acne pen.

FIG. 8 is a perspective view of a second embodiment of the acne pen.

FIG. 9 is a front view of the second embodiment of the acne pen.

FIG. 10 is a back view of the second embodiment of the acne pen.

FIG. 11 is a left view of the second embodiment of the acne pen.

FIG. 12 is a right view of the second embodiment of the acne pen.

FIG. 13 is a top view of the second embodiment of the acne pen; and,

FIG. 14 is a bottom view of the second embodiment of the acne pen.

The broken lines immediately adjacent the shaded areas represent the bounds of the claim, while all other broken lines are directed to environment and are for illustrative purposes only; the broken lines form no part of the claimed design.

1 Claim, 12 Drawing Sheets

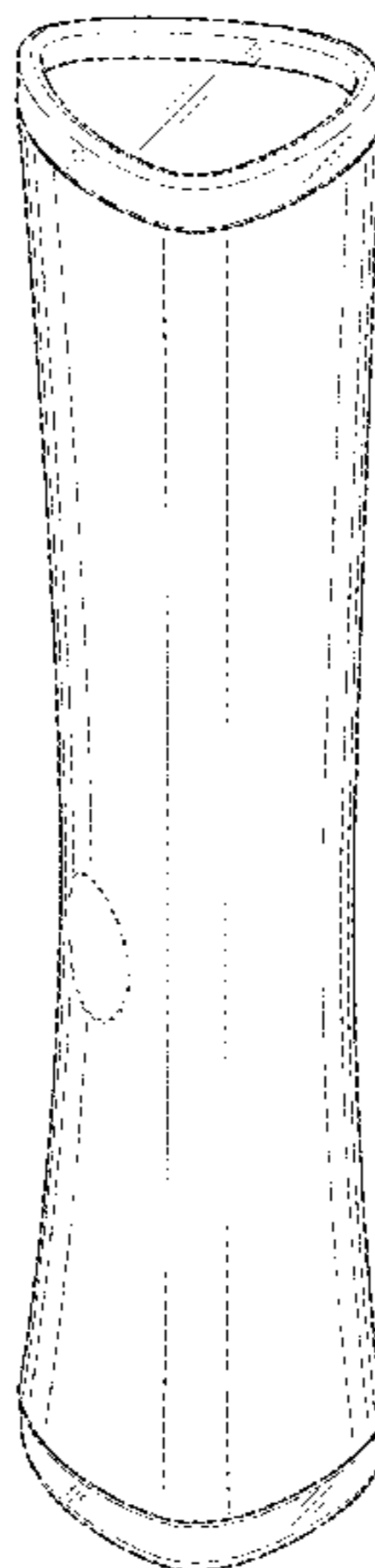

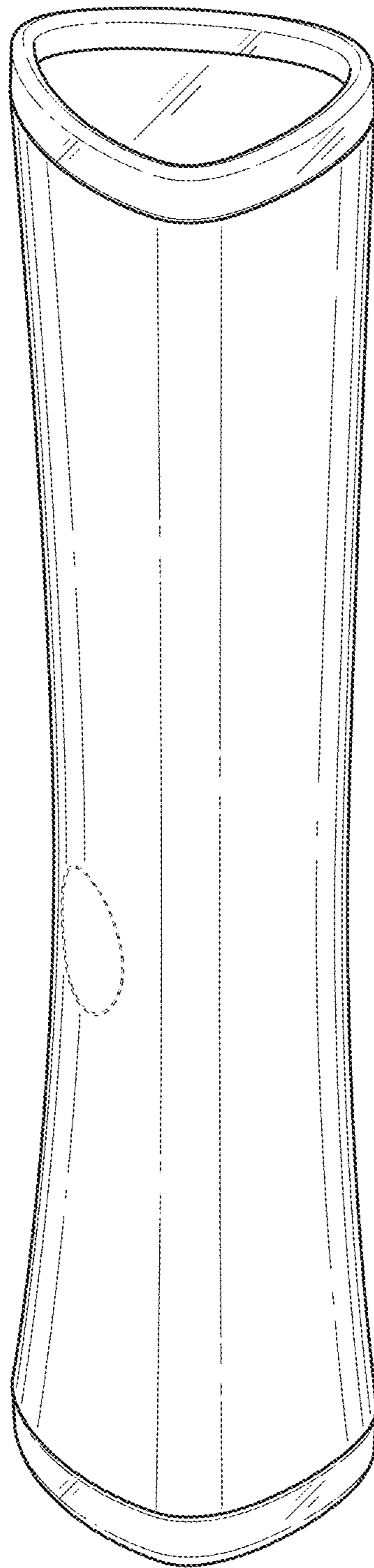

FIG. 1

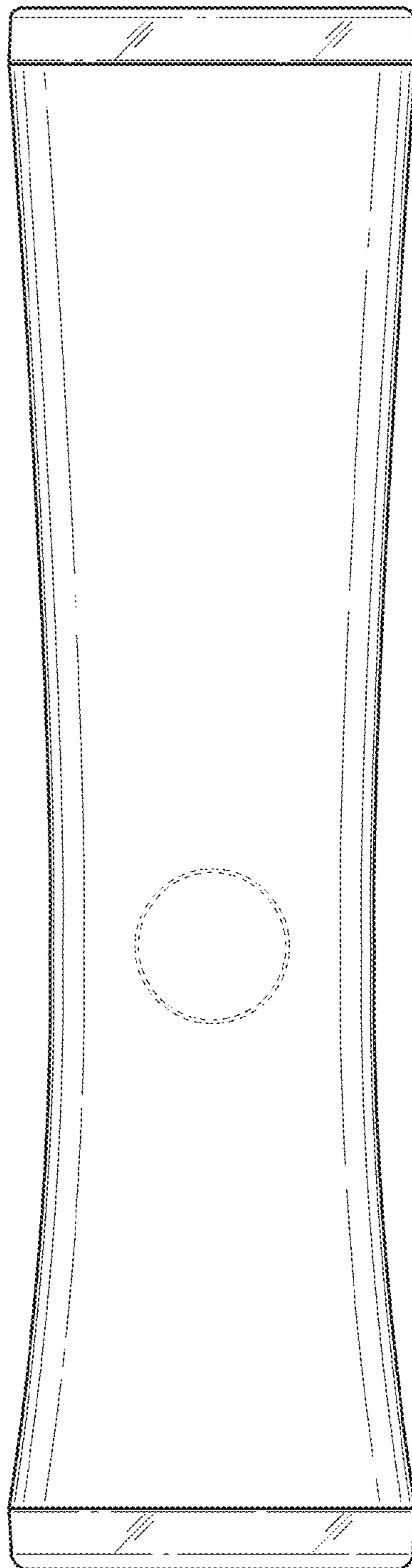

FIG. 2

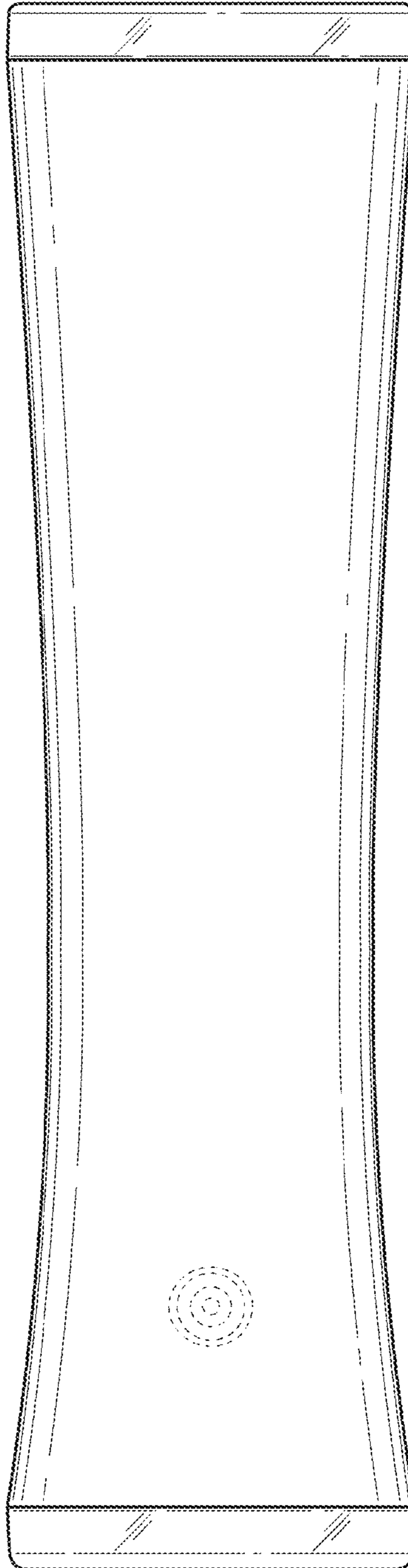

FIG. 3

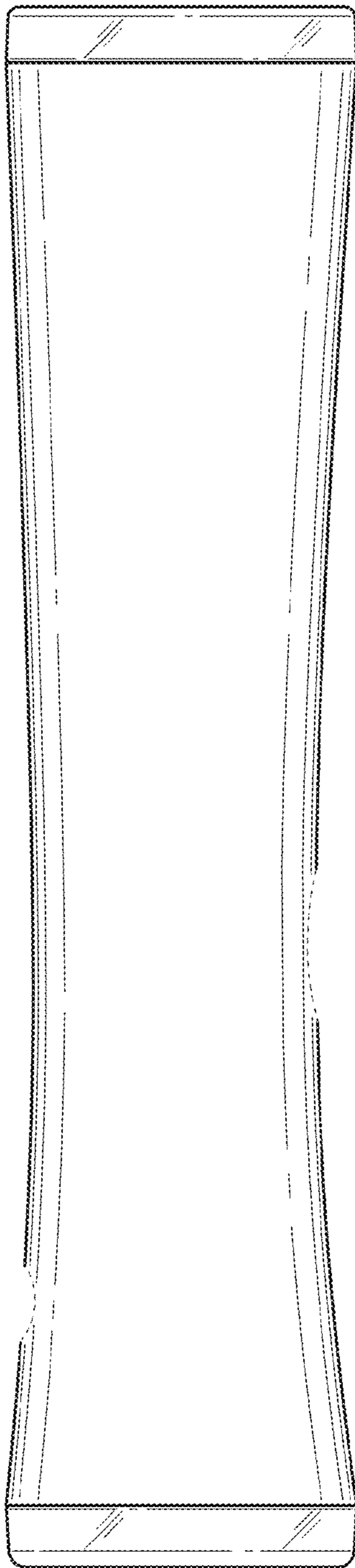

FIG. 4

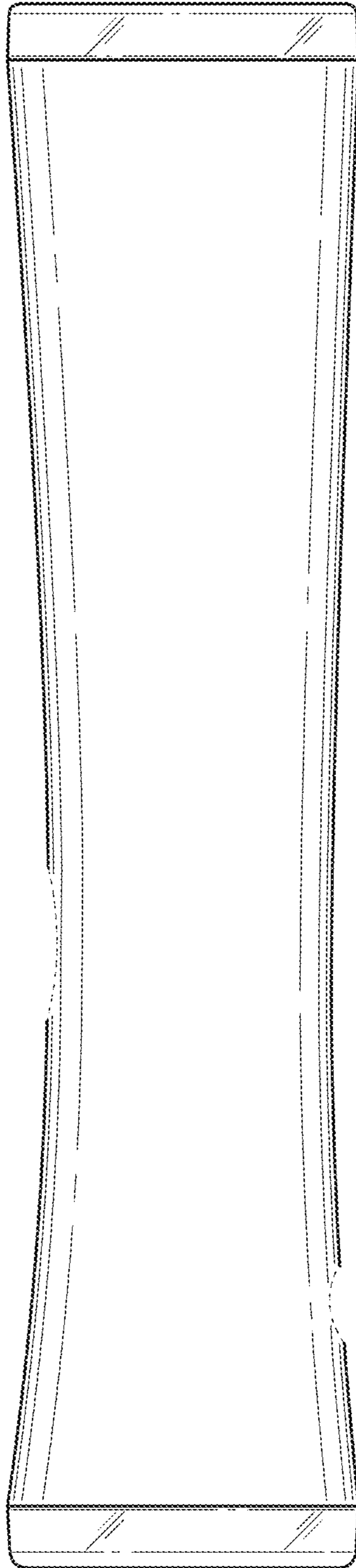

FIG. 5

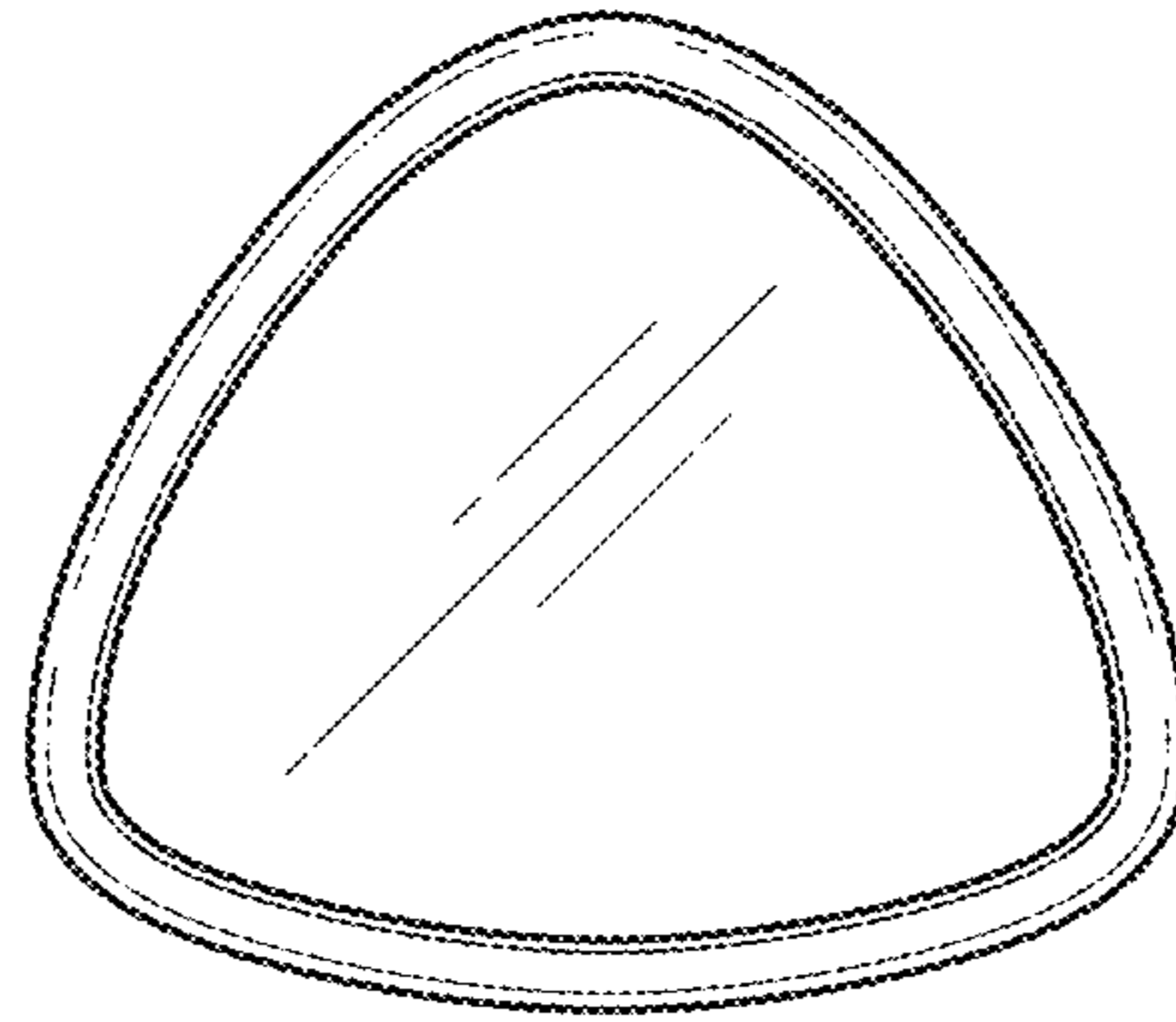

FIG. 6

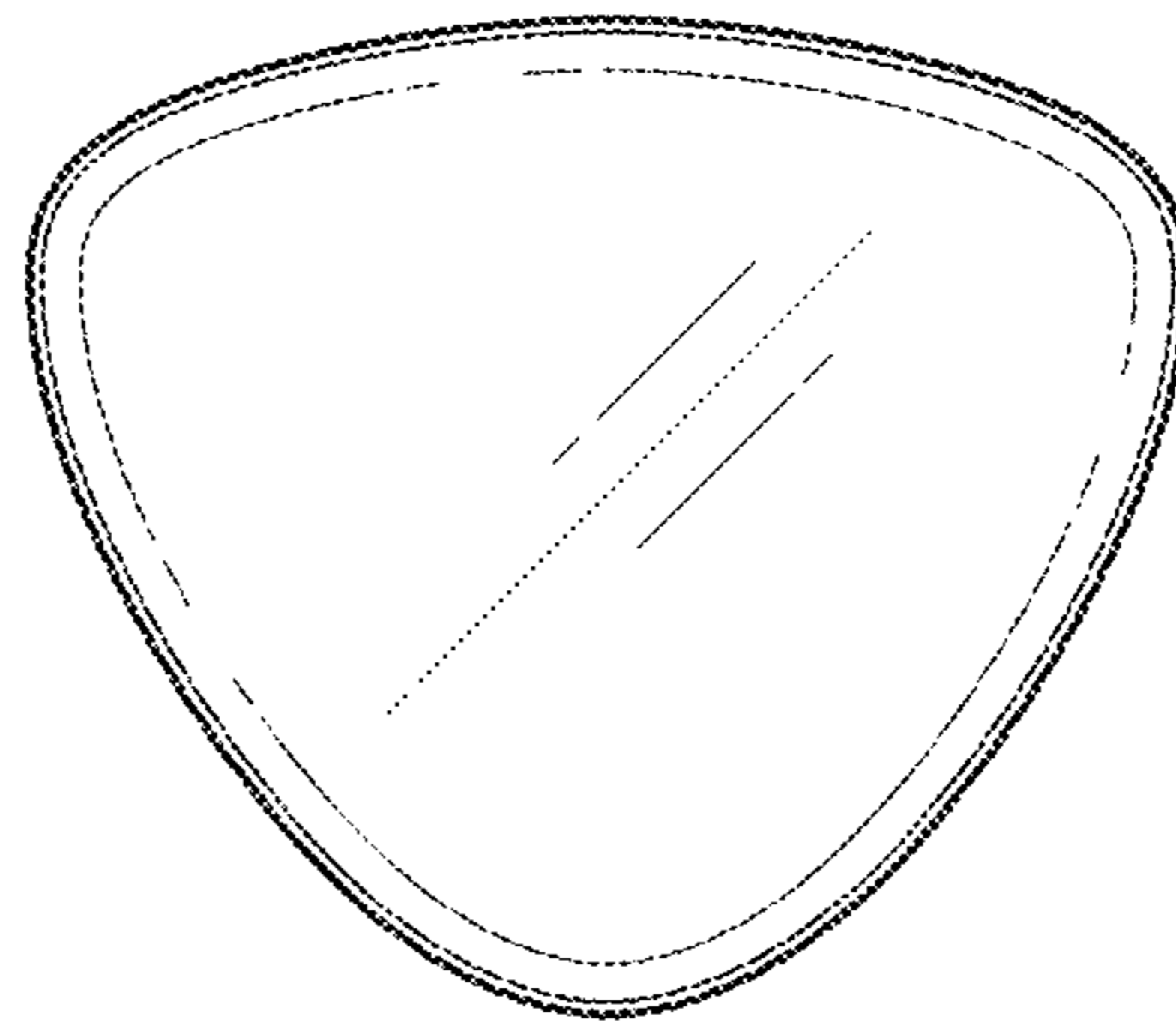

FIG. 7

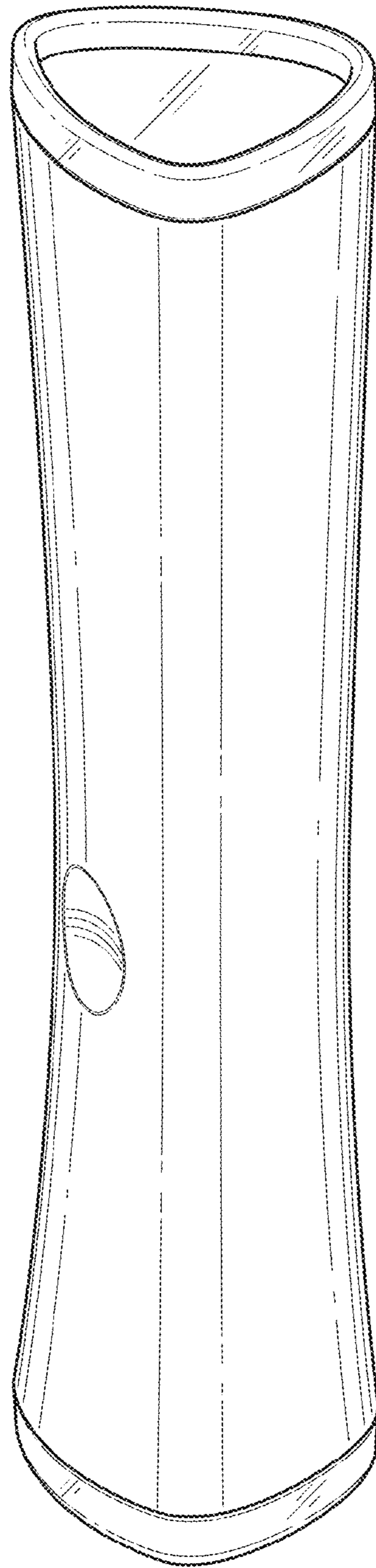

FIG. 8

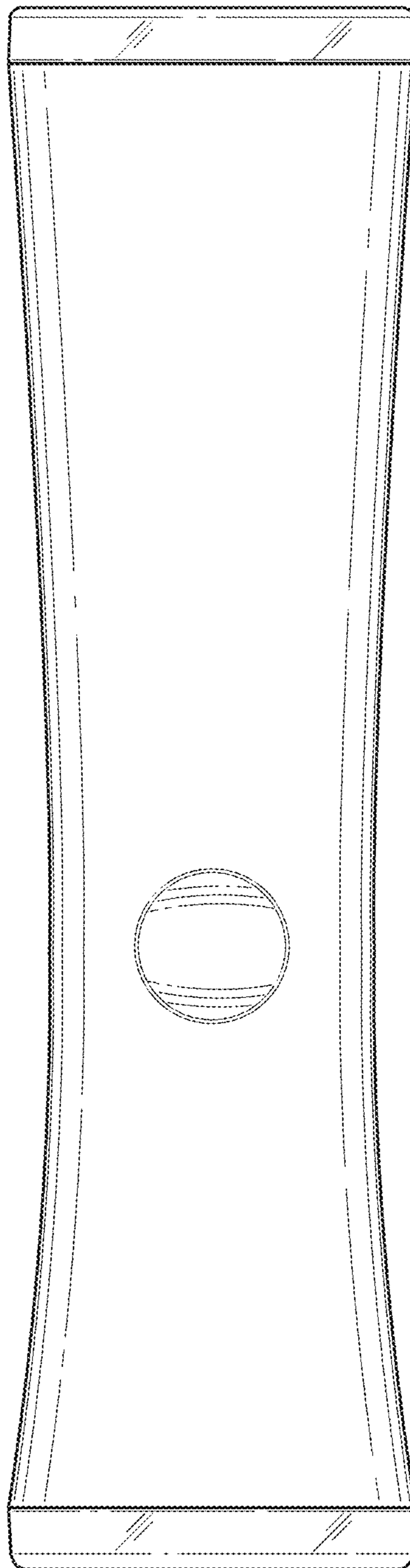

FIG. 9

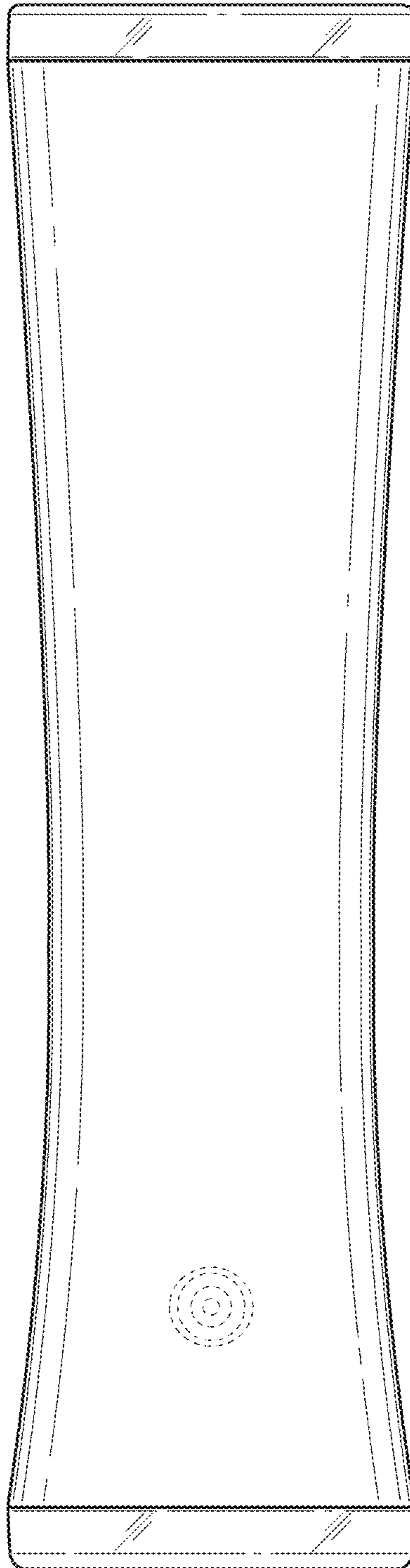

FIG. 10

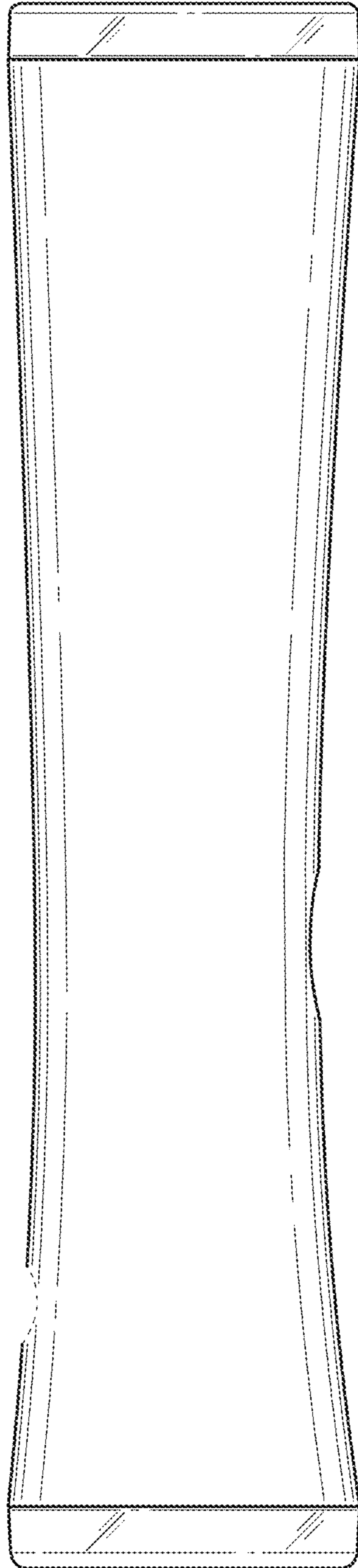

FIG. 11

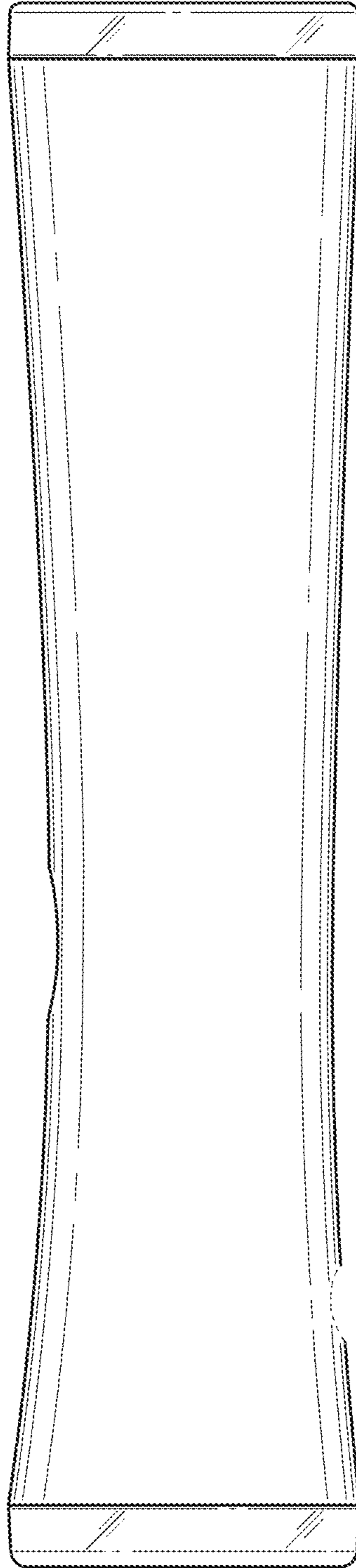

FIG. 12

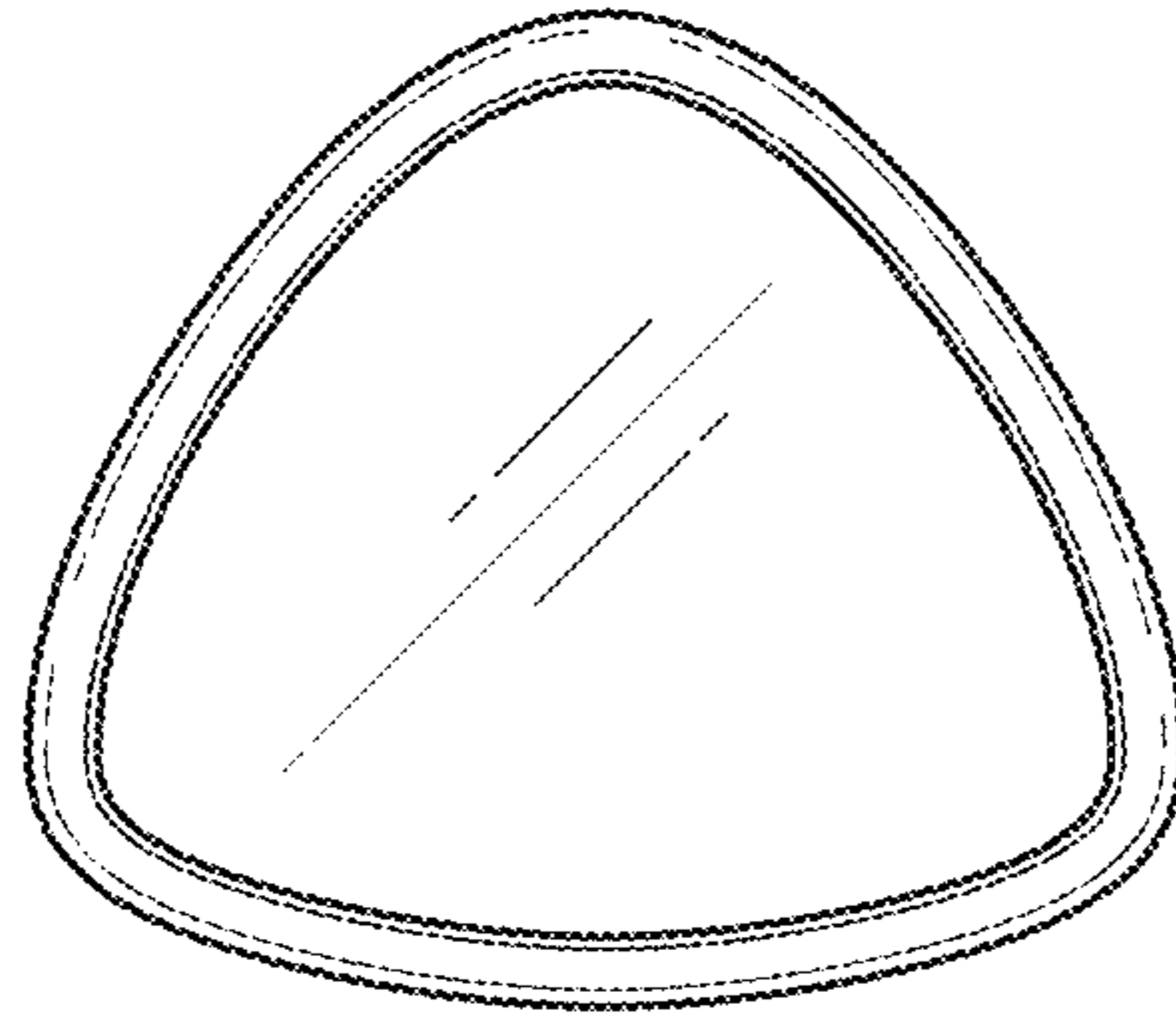

FIG. 13

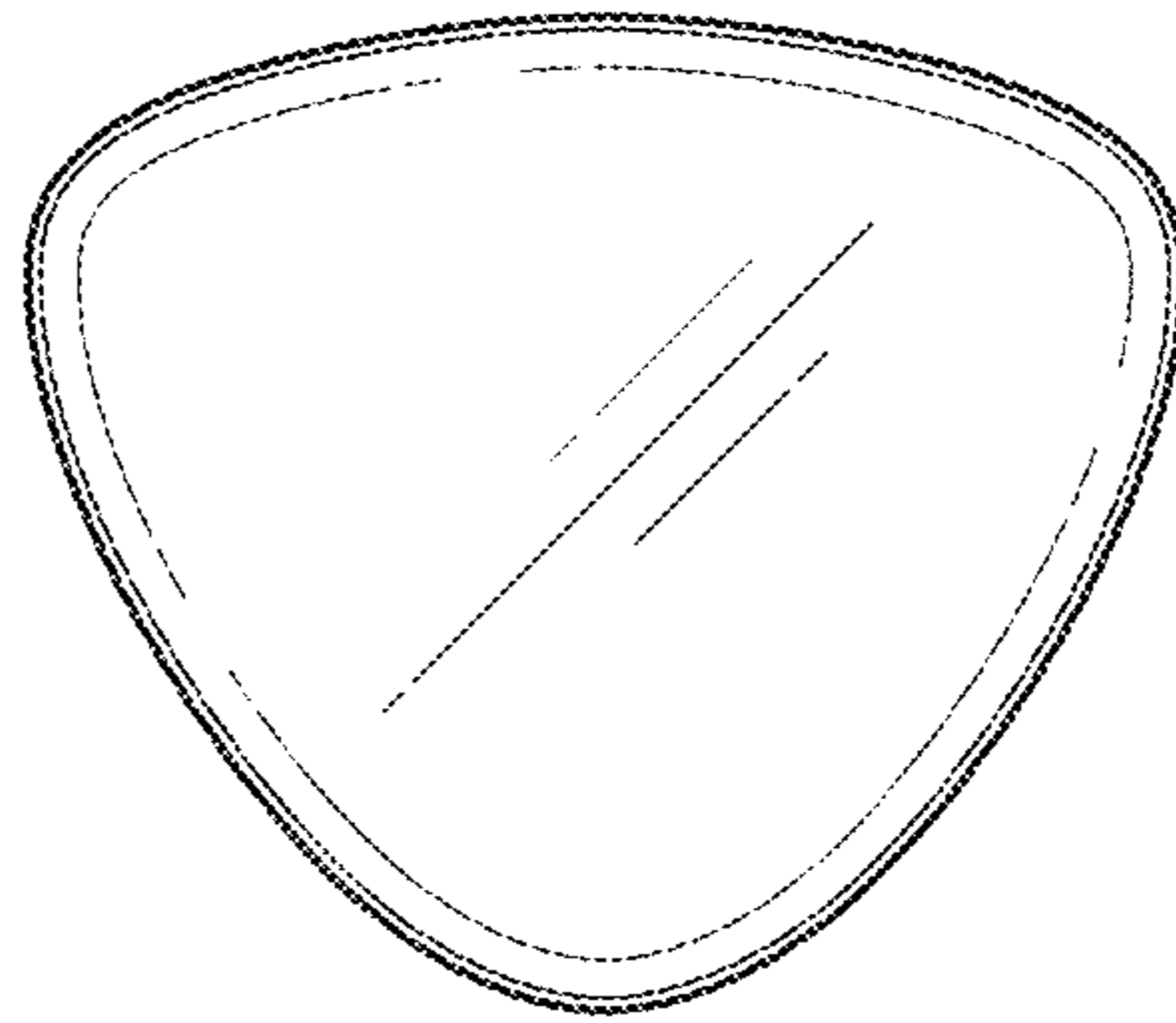

FIG. 14