

US00D760887S

(12) **United States Design Patent**
Dittrich et al.

(10) **Patent No.:** **US D760,887 S**
(45) **Date of Patent:** **** Jul. 5, 2016**

- (54) **EAR PLUG FOR WATER SPORTS**
- (71) Applicant: **Frankly Development AB**, Malmö (SE)
- (72) Inventors: **Christian Dittrich**, Löderup (SE); **Claes Lundin**, Malmö (SE); **Kasimir Hellström**, Lund (SE)
- (73) Assignee: **EAR LABS AB**, Malmö (SE)
- (**) Term: **14 Years**
- (21) Appl. No.: **29/497,230**
- (22) Filed: **Jul. 22, 2014**
- (51) **LOC (10) Cl.** **24-04**
- (52) **U.S. Cl.**
USPC **D24/106**
- (58) **Field of Classification Search**
USPC D24/106, 173, 174; D14/205, 206, 223;
D29/112
CPC A61F 11/08; A61F 11/10; A61F 2011/085
See application file for complete search history.

D539,415 S *	3/2007	Fleming	D24/106
D567,230 S *	4/2008	Seto	D14/223
D578,638 S *	10/2008	Falco	D24/106
D578,639 S *	10/2008	Falco	D24/106
D591,732 S *	5/2009	Burton	D14/223
2010/0294285 A1 *	11/2010	Turdjian	128/867

* cited by examiner

Primary Examiner — Richelle G Shelton

(74) *Attorney, Agent, or Firm* — Larson & Larson, P.A.; Frank Liebenow; Justin Miller

(57) **CLAIM**

The ornamental design for an ear plug for water sports, as shown and described.

DESCRIPTION

FIG. 1 is a top view of an ear plug for water sports showing our new design;
 FIG. 2 is a left-side view thereof;
 FIG. 3 is a right-side view thereof;
 FIG. 4 is a perspective front view thereof;
 FIG. 5 is a perspective back view thereof;
 FIG. 6 is a front view thereof; and,
 FIG. 7 is a bottom view thereof.
 The broken lines in FIG. 3 and FIG. 5 form no part of the claimed design, as the inside portion is excluded from the claim.

(56) **References Cited**

U.S. PATENT DOCUMENTS

5,881,729 A *	3/1999	Castillo	128/864
D492,991 S *	7/2004	Chiang	D24/106
D521,637 S *	5/2006	Yang	D24/106

1 Claim, 7 Drawing Sheets

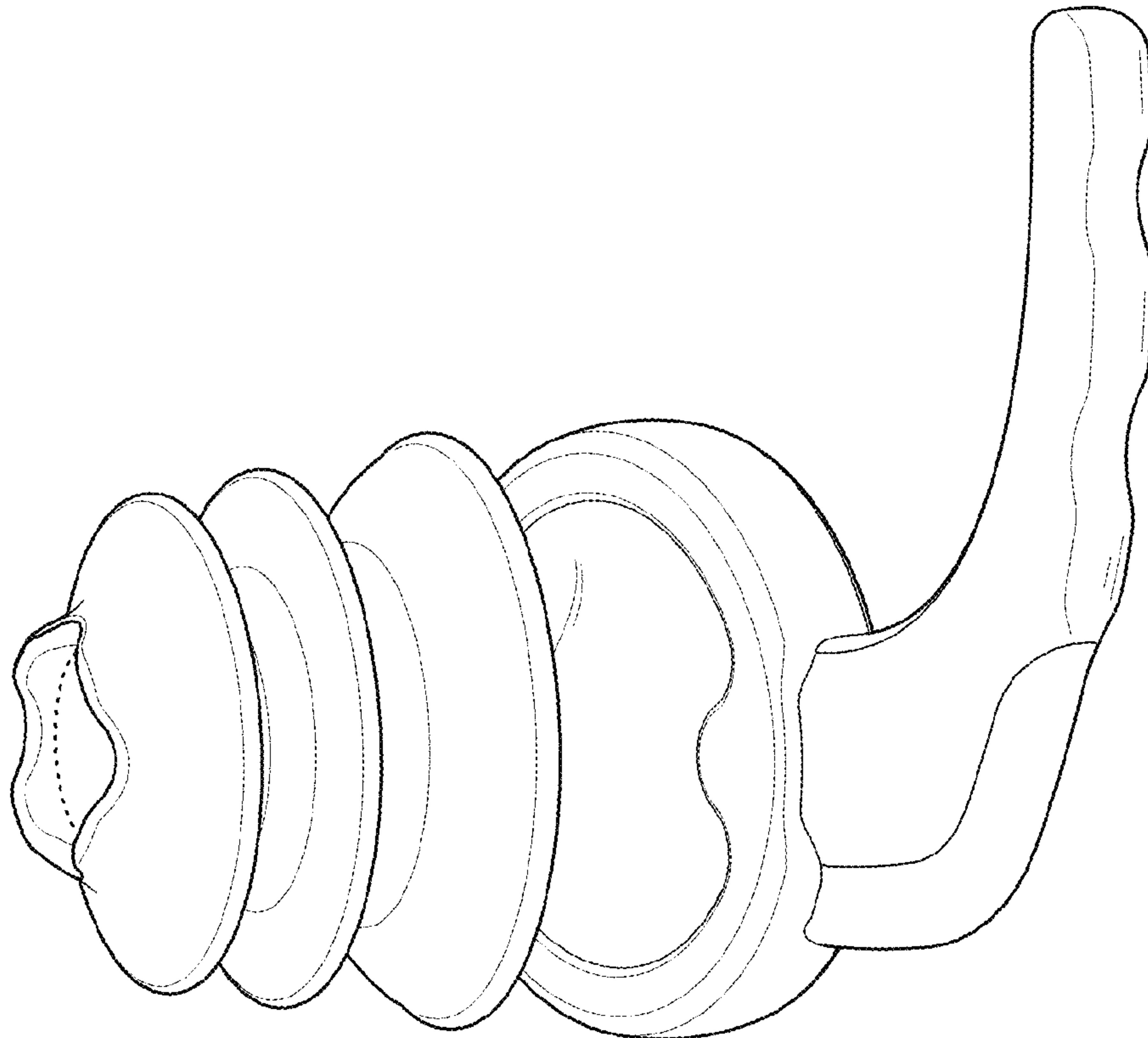

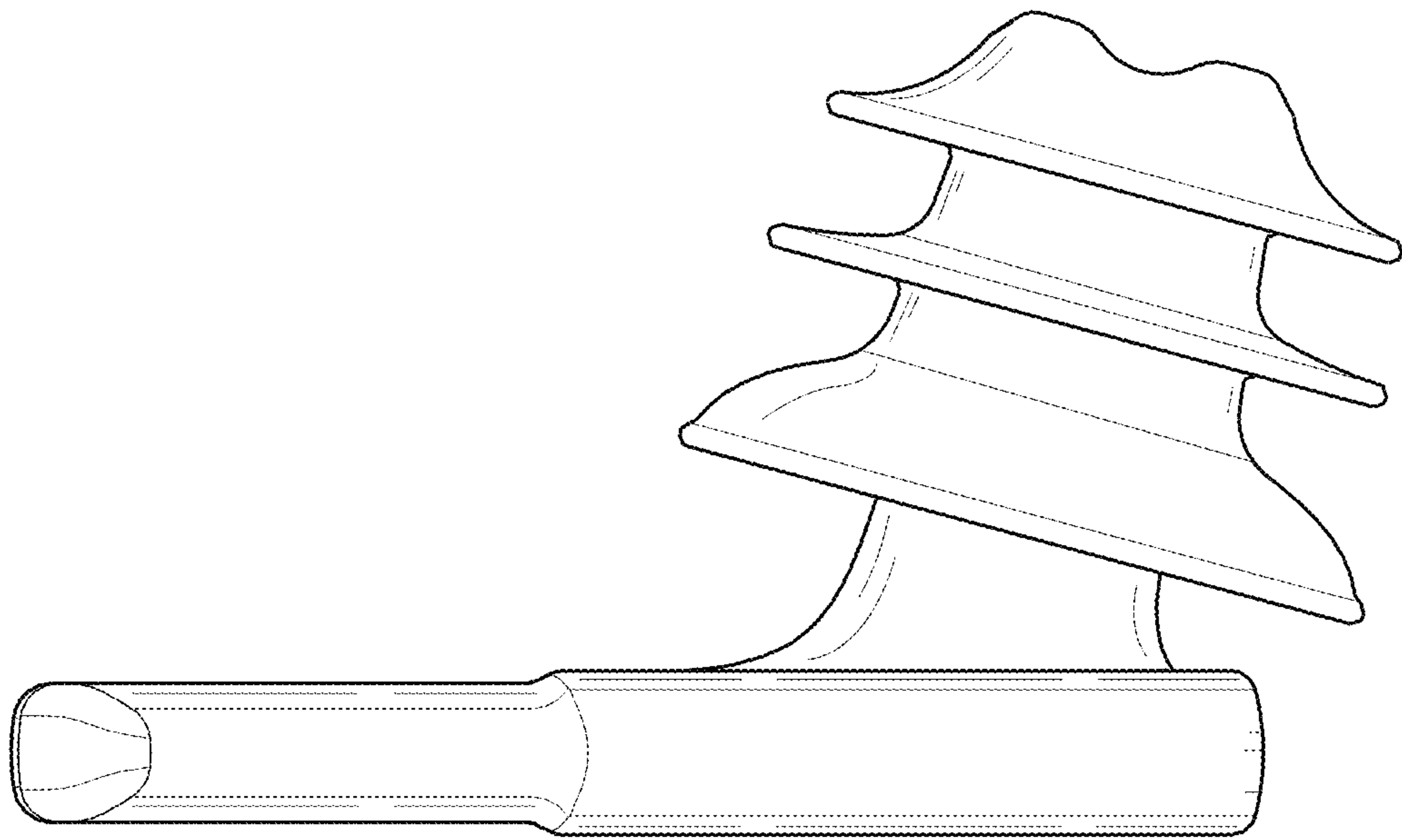

Fig. 1

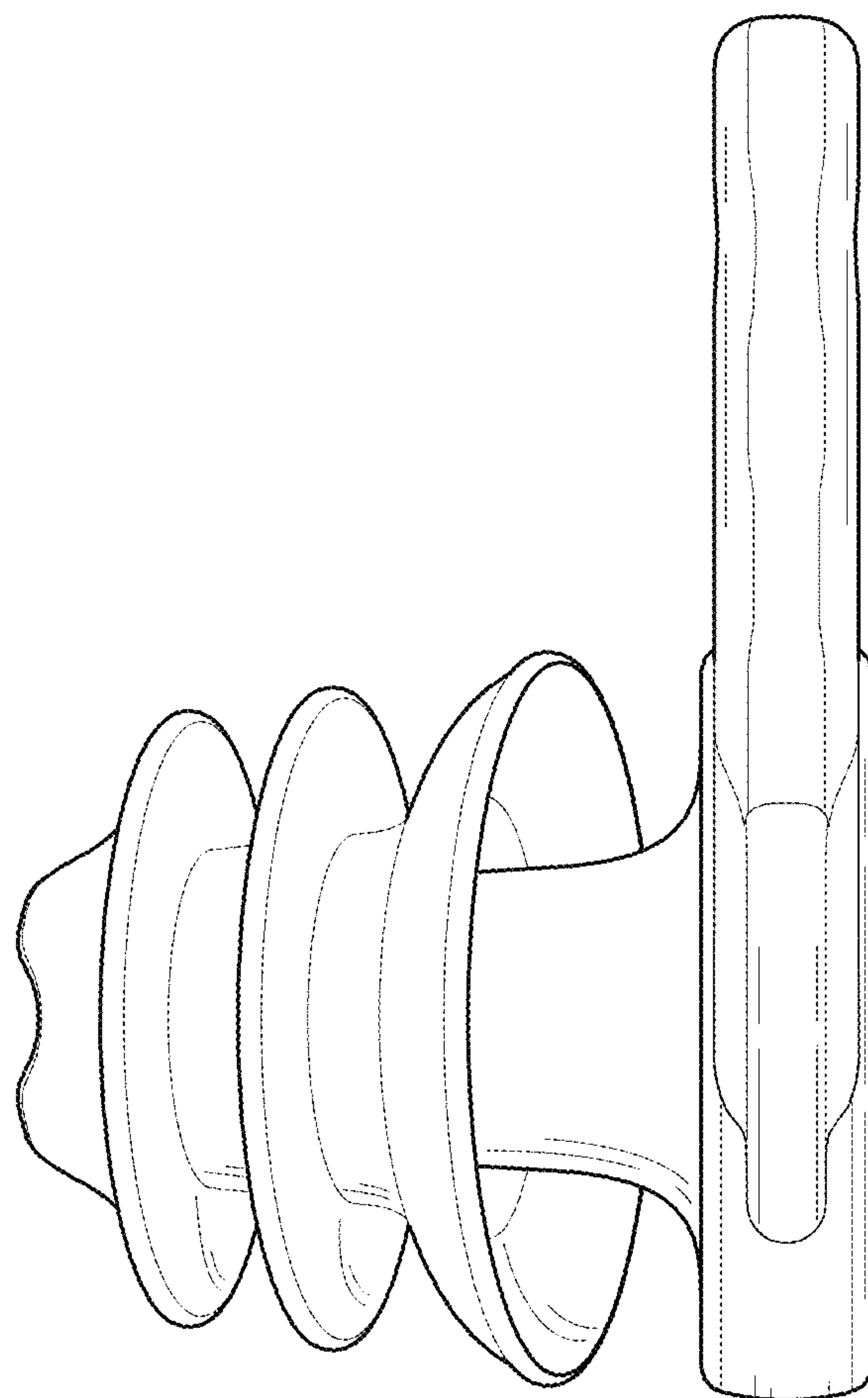

Fig. 2

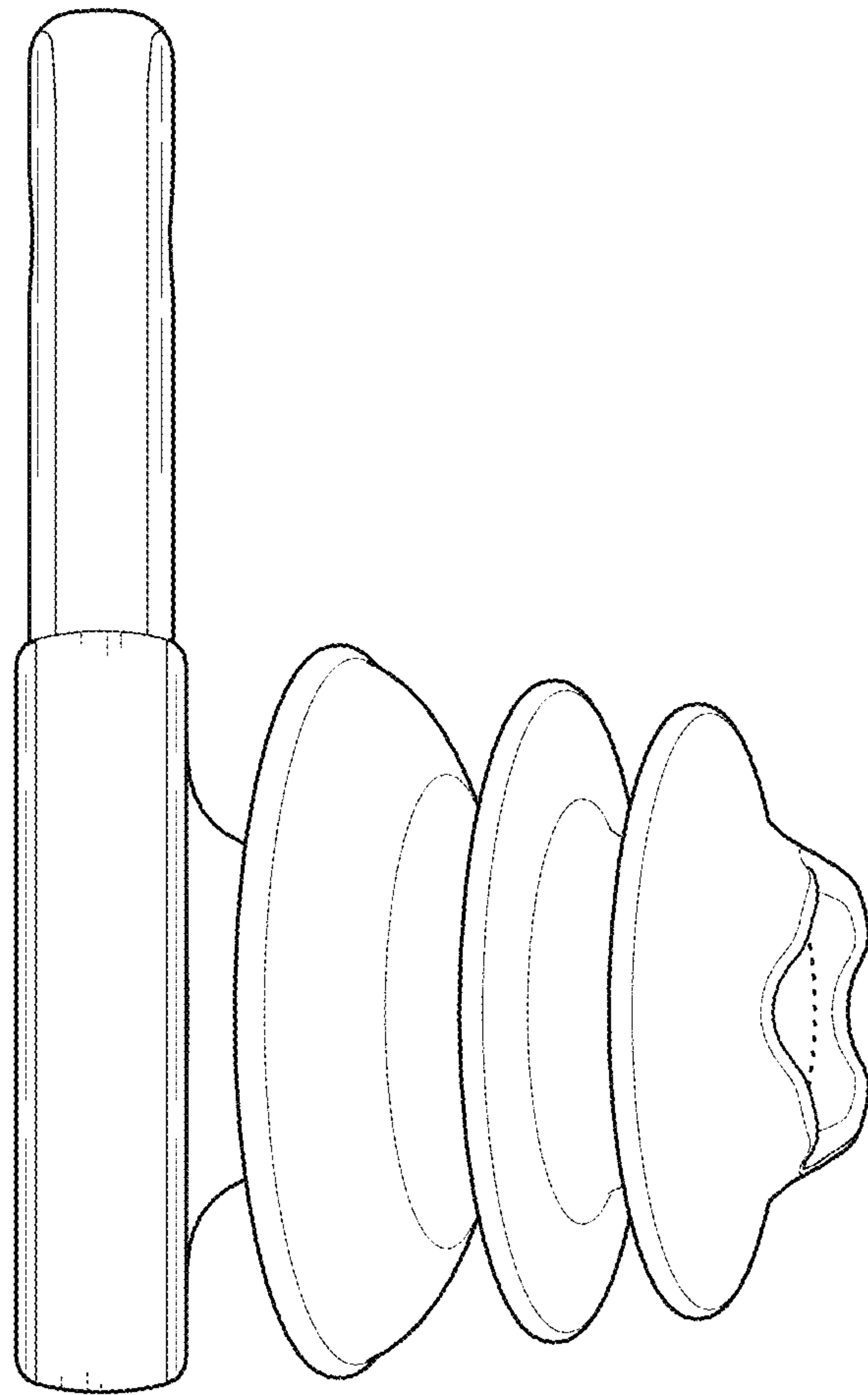

Fig. 3

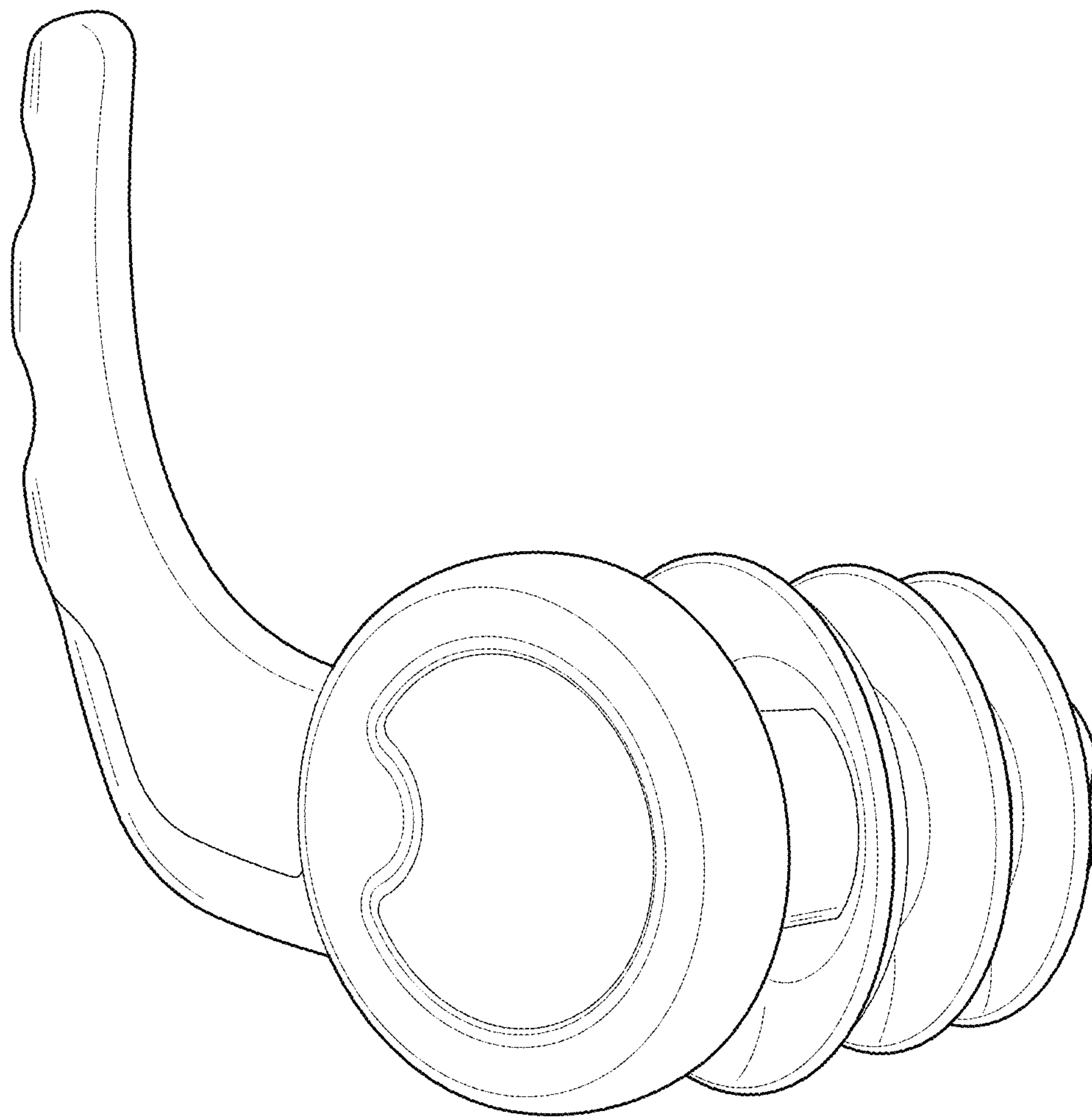

Fig. 4

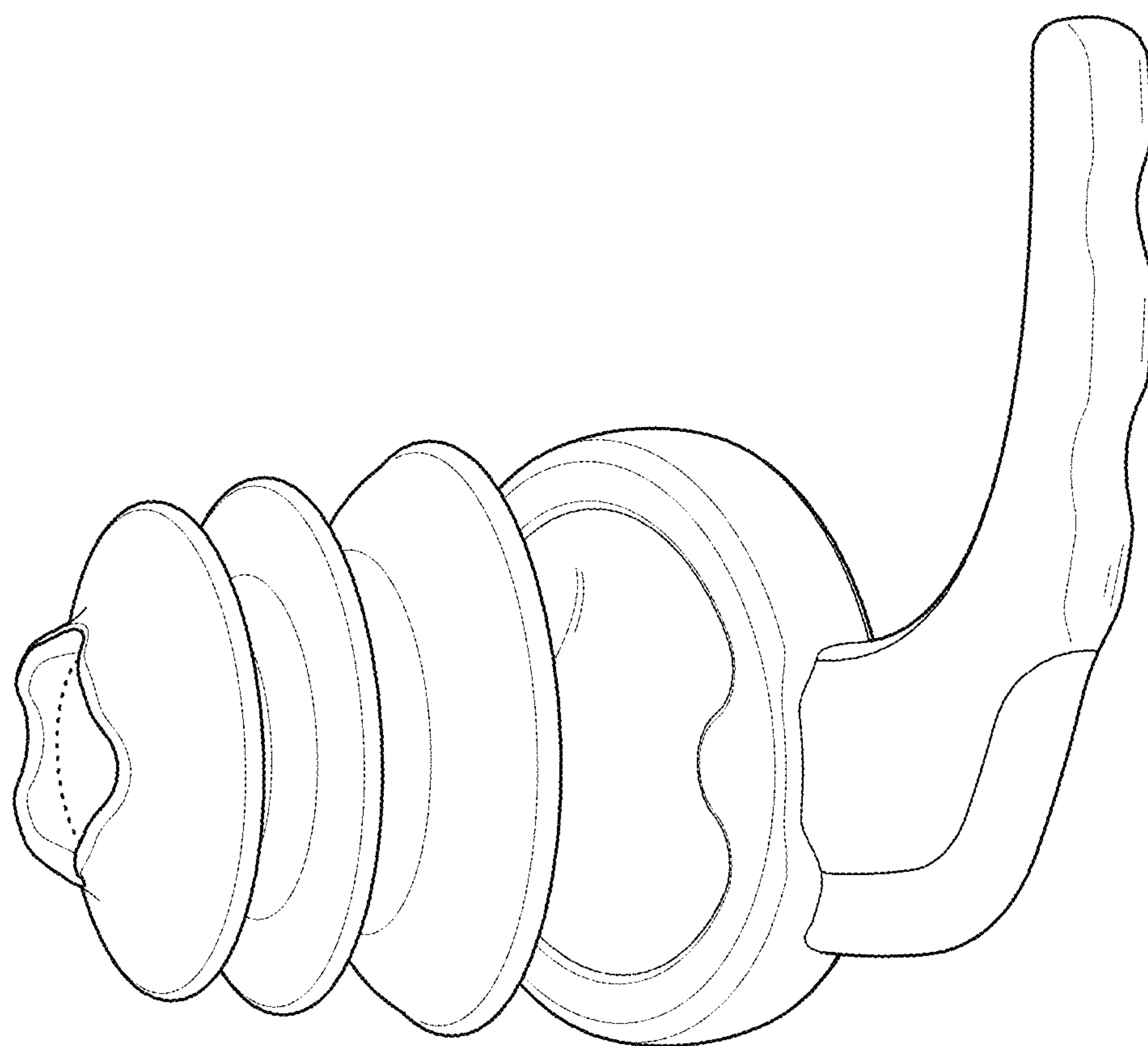

Fig. 5

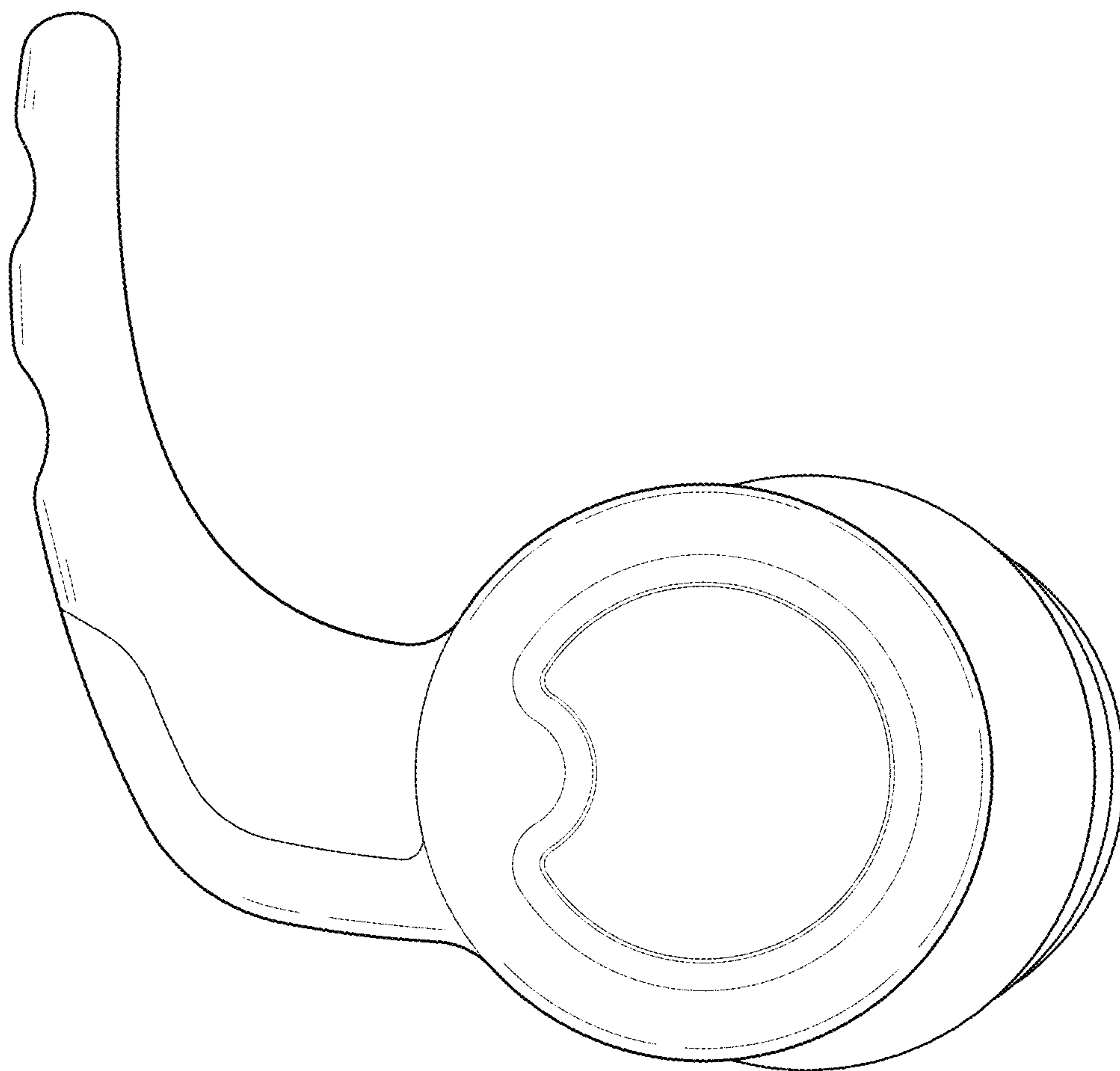

Fig. 6

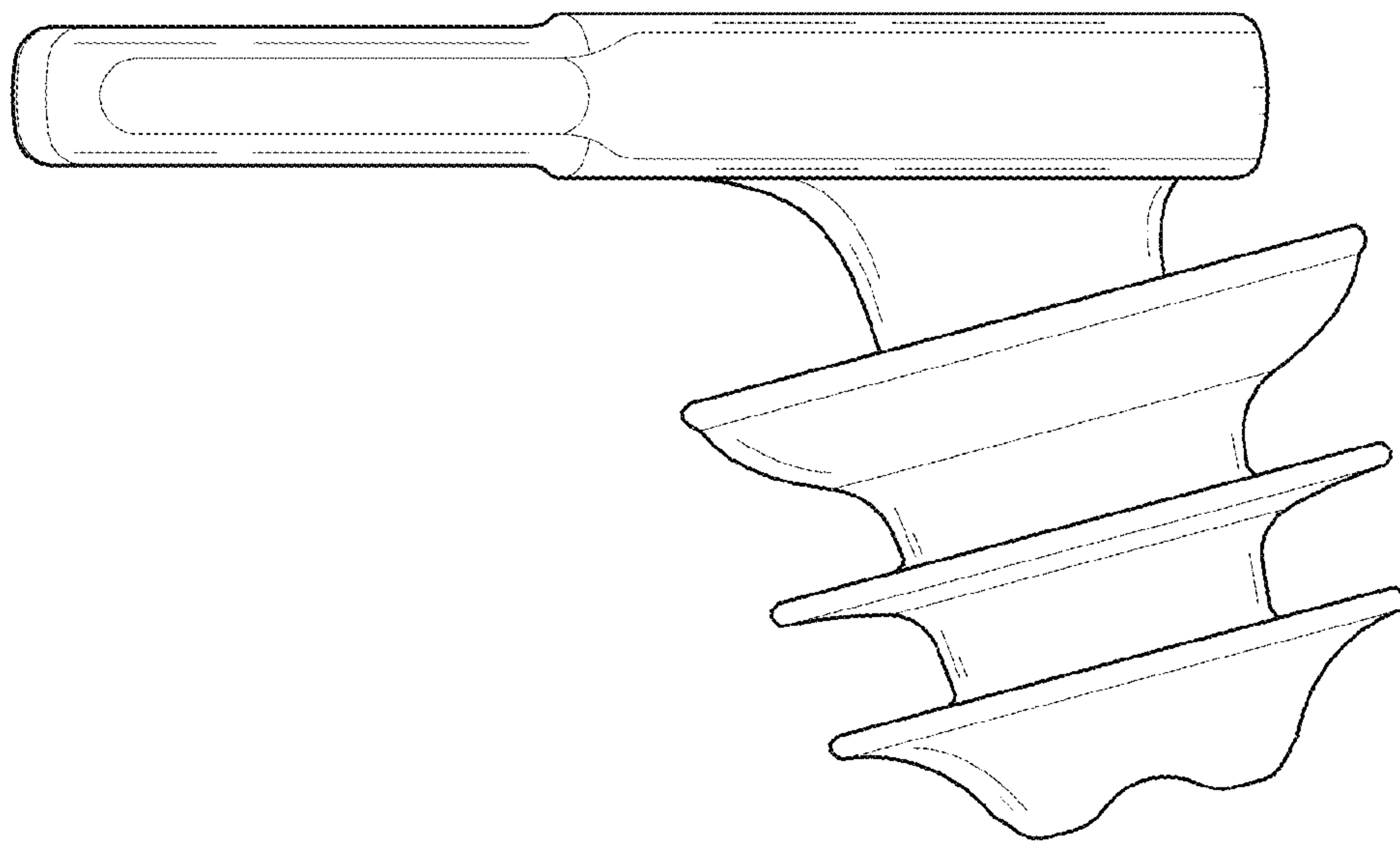

Fig. 7