



US00D760821S

(12) **United States Design Patent**
Lee

(10) **Patent No.:** **US D760,821 S**
(45) **Date of Patent:** **** Jul. 5, 2016**

(54) **REFRIGERATOR**

(71) Applicant: **LG ELECTRONICS INC.**, Seoul (KR)

(72) Inventor: **Joojeung Lee**, Seoul (KR)

(73) Assignee: **LG ELECTRONICS INC.**, Seoul (KR)

(**) Term: **14 Years**

(21) Appl. No.: **29/522,060**

(22) Filed: **Mar. 27, 2015**

(30) **Foreign Application Priority Data**

Jan. 13, 2015 (KR) 30-2015-0001574

(51) **LOC (10) Cl.** **15-07**

(52) **U.S. Cl.**
USPC **D15/91**

(58) **Field of Classification Search**
USPC D15/79-91
CPC F25D 23/028; F25D 23/02; F25D 25/025;
F25D 23/00; F25D 2323/021; F25D 11/00;
F25D 2323/024; F25D 23/04; F25D 29/00;
F25D 25/02; F25D 25/024; F25D 27/005;
F25D 23/12; F25D 29/005; F25D 17/042;
F25D 2325/021

See application file for complete search history.

(56) **References Cited**

U.S. PATENT DOCUMENTS

D325,918 S *	5/1992	Lloyd	D15/81
D648,359 S *	11/2011	Yu	D15/91
D714,848 S *	10/2014	Park	D15/91
D742,436 S *	11/2015	Park	D15/91
D744,549 S *	12/2015	Park	D15/91
D744,551 S *	12/2015	Park	D15/91

* cited by examiner

Primary Examiner — Daniel Bui

Assistant Examiner — Khawaja Anwar

(74) *Attorney, Agent, or Firm* — Birch, Stewart, Kolasch & Birch, LLP

(57) **CLAIM**

I claim the ornamental design for a refrigerator as shown and described.

DESCRIPTION

FIG. 1 is a perspective view of a refrigerator showing my new design with its double door closed:

FIG. 2 is a front elevation view thereof;

FIG. 3 is a rear elevation view thereof;

FIG. 4 is a left-side elevation view thereof;

FIG. 5 is a right-side elevation view thereof;

FIG. 6 is a top plan view thereof;

FIG. 7 is a bottom plan view thereof;

FIG. 8 is a perspective view thereof, shown in an open condition;

FIG. 9 is a front elevation view thereof;

FIG. 10 is a right side elevation view thereof;

FIG. 11 is a top plan view thereof;

FIG. 12 is another perspective view thereof, shown in another open condition;

FIG. 13 is a front elevation view thereof;

FIG. 14 is a right side elevation view thereof;

FIG. 15 is a top plan view thereof; and,

FIG. 16 is another perspective view as seen in FIG. 1, shown in use condition.

The broken lines in the drawing figures are included for the purpose of illustrating environment and form no part of the claimed design.

1 Claim, 15 Drawing Sheets

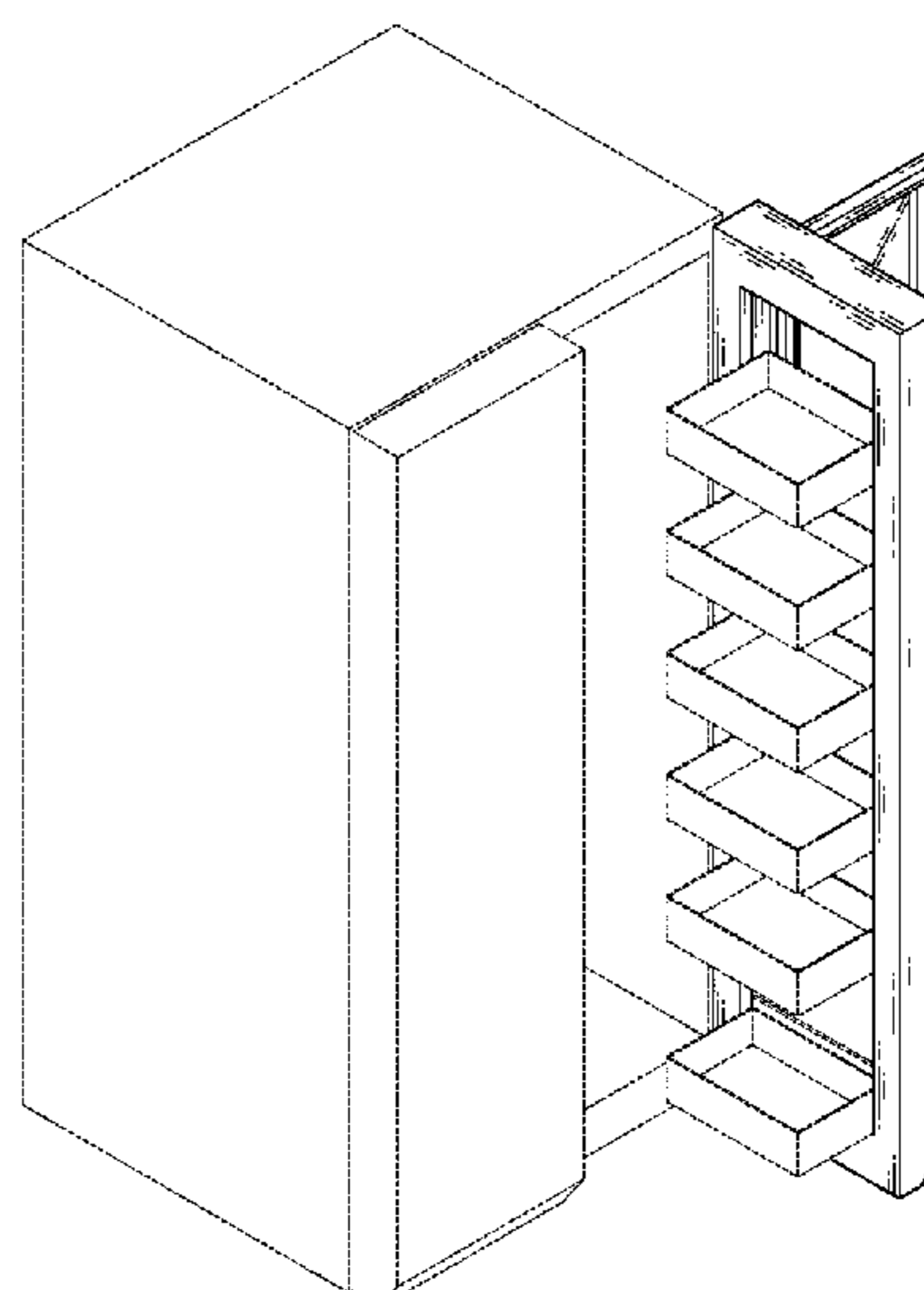
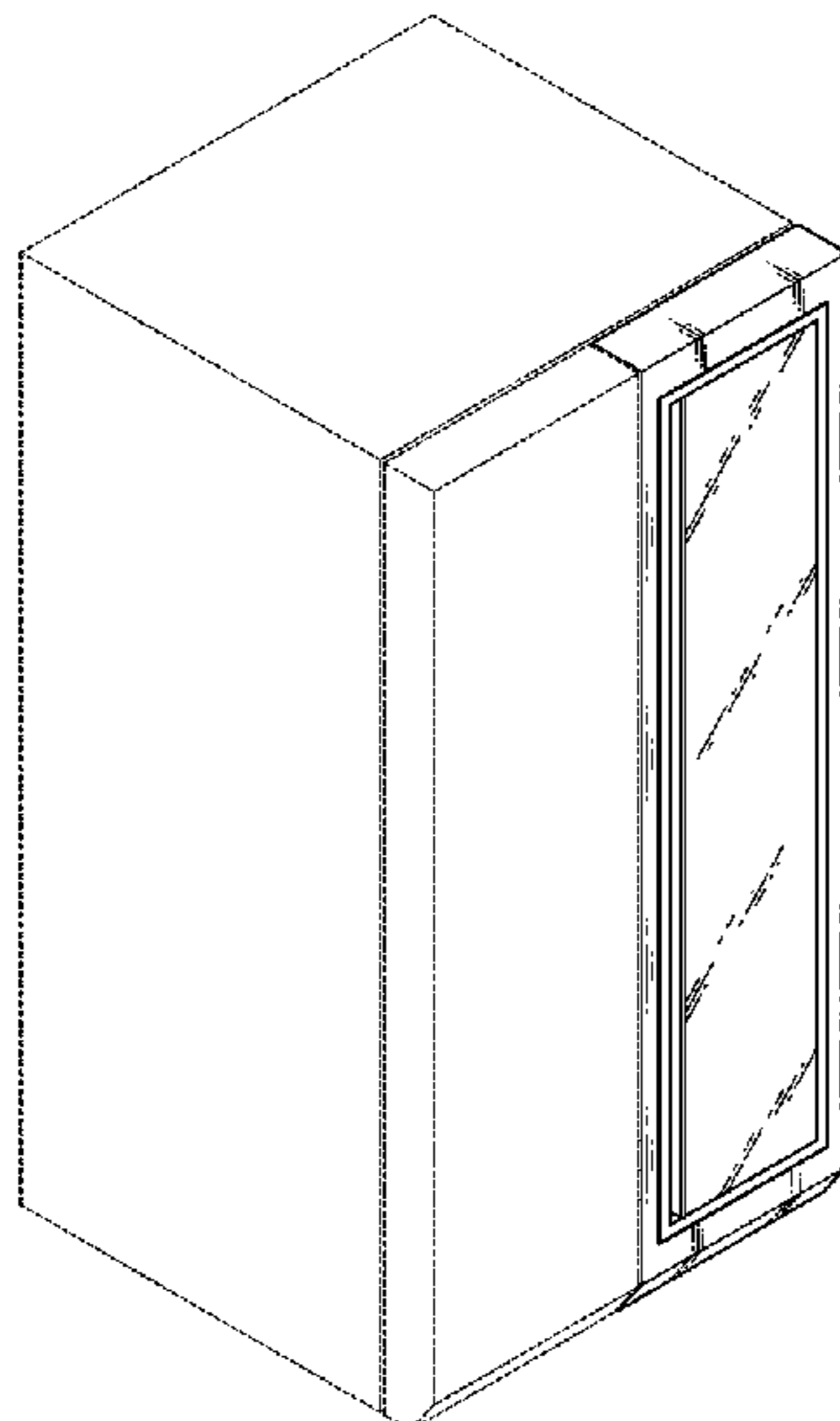

FIG. 1

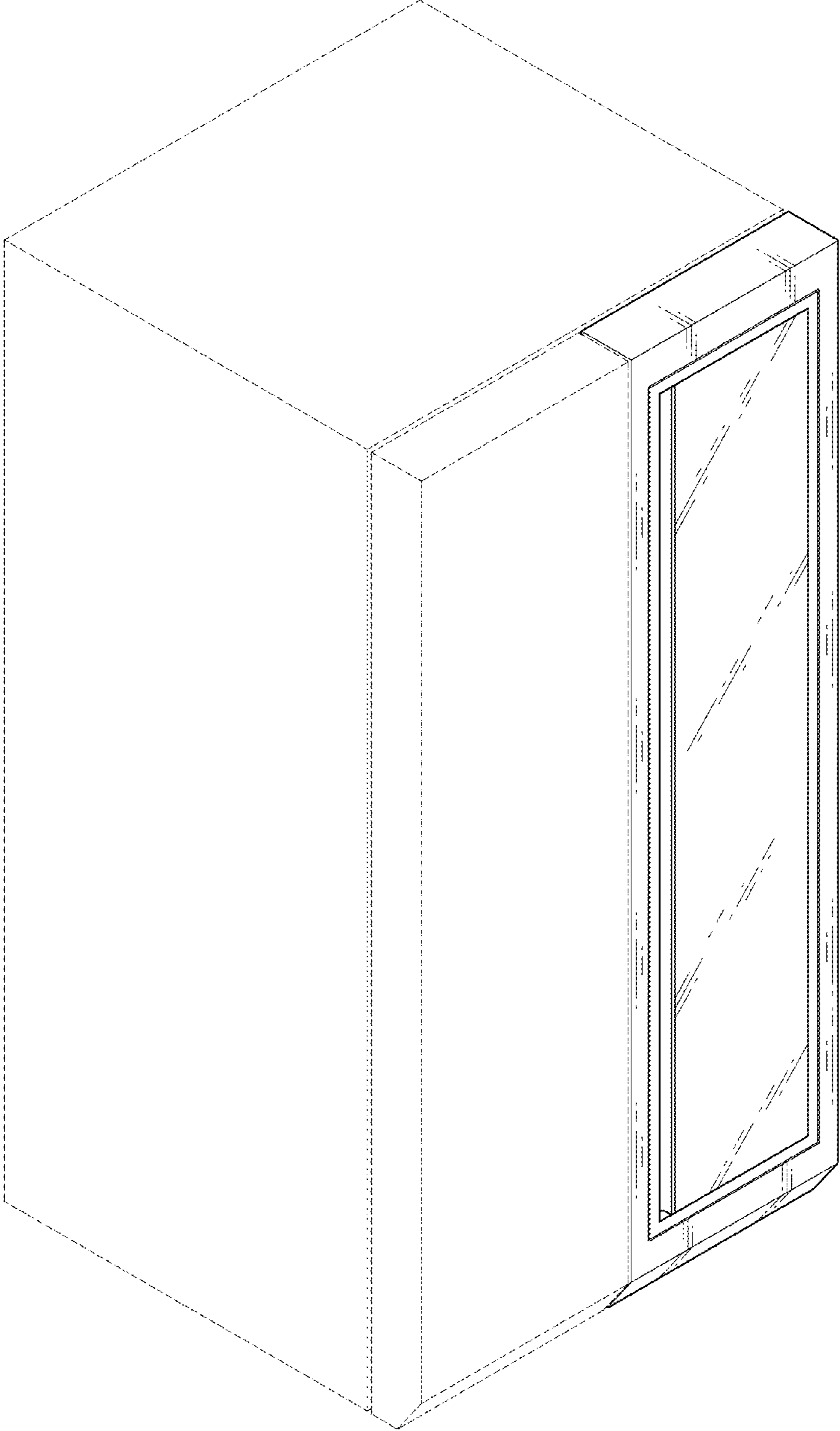

FIG. 2

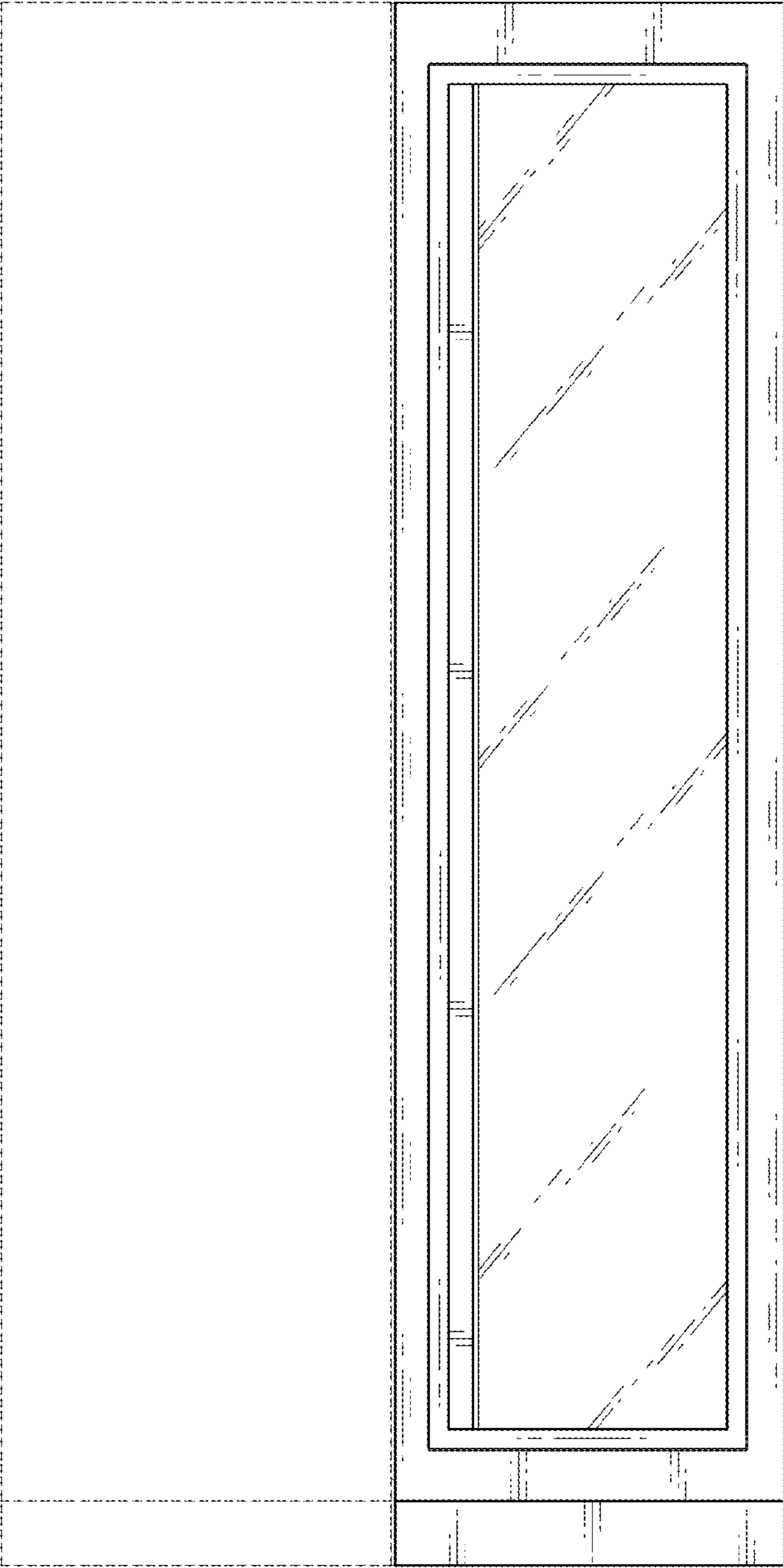

FIG. 3



FIG. 4

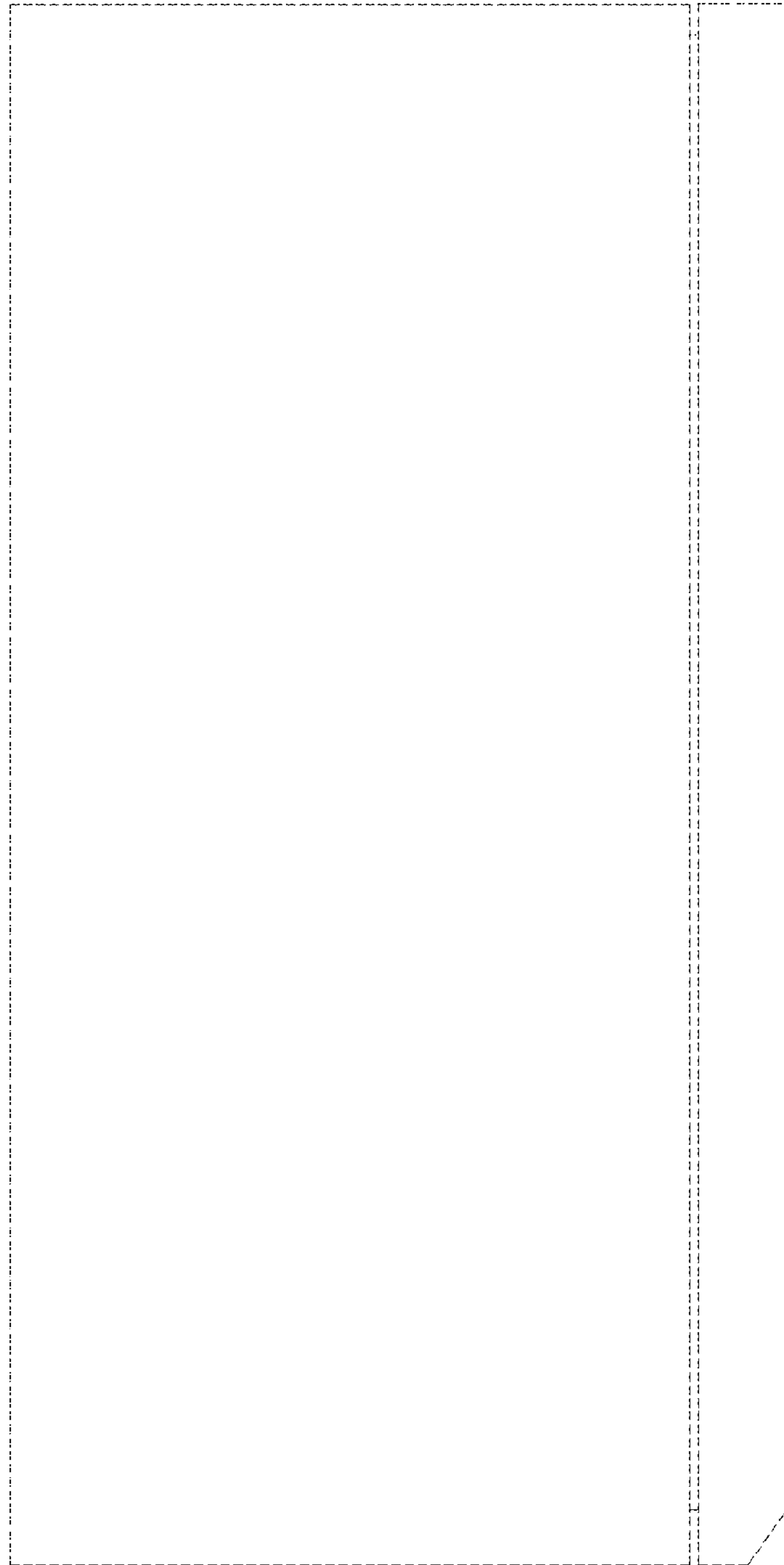

FIG. 5

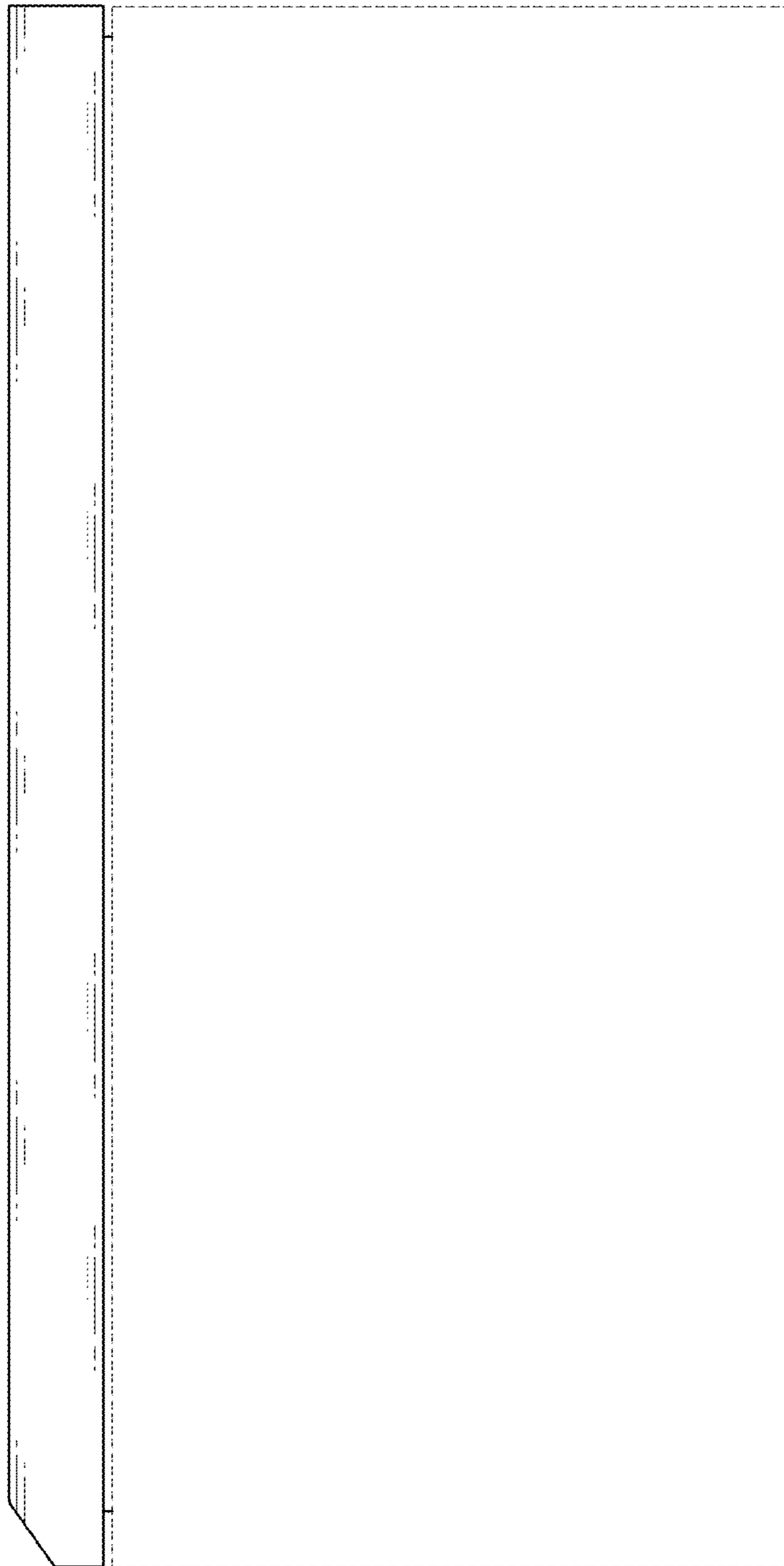

FIG. 6

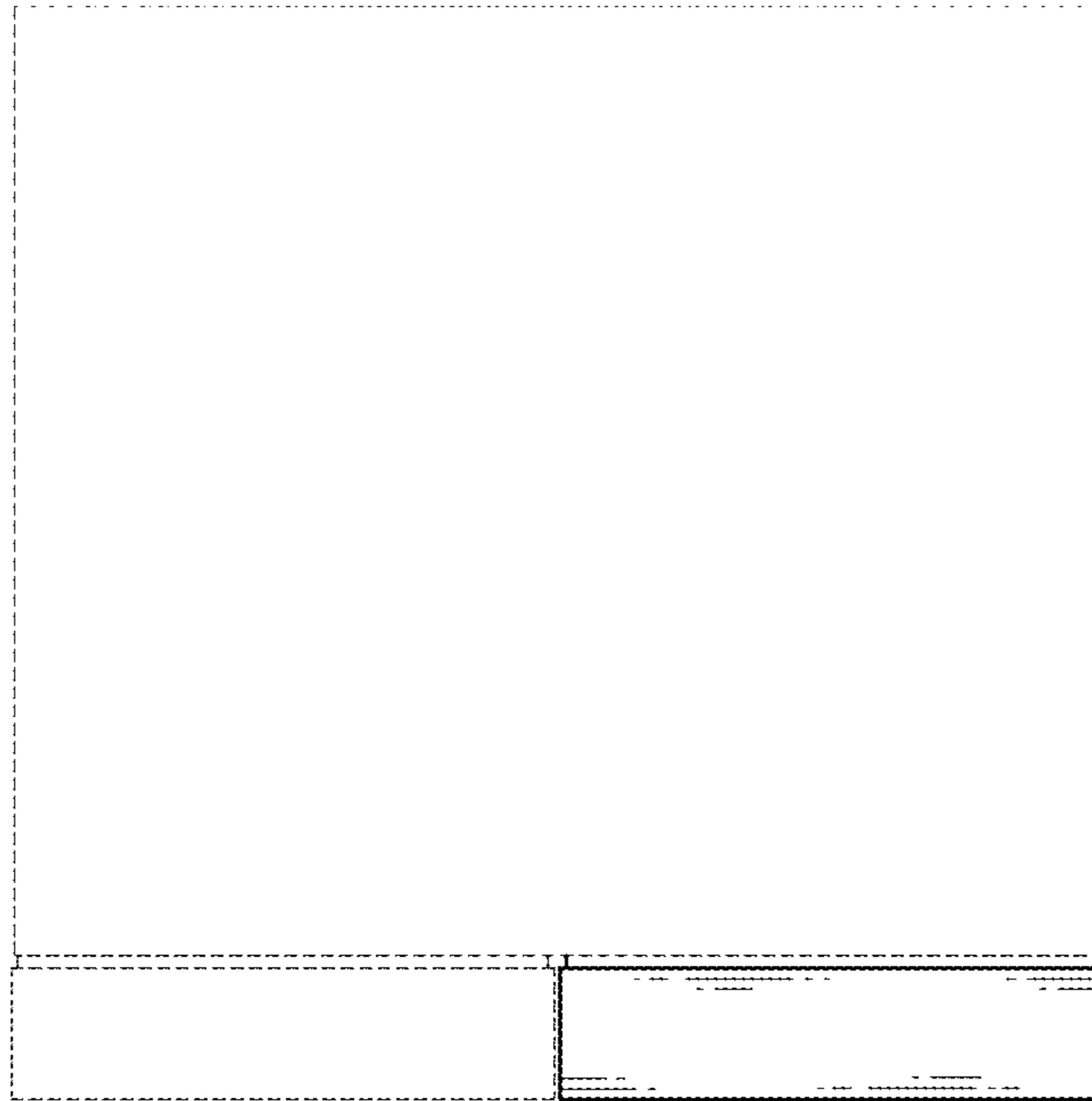

FIG. 7

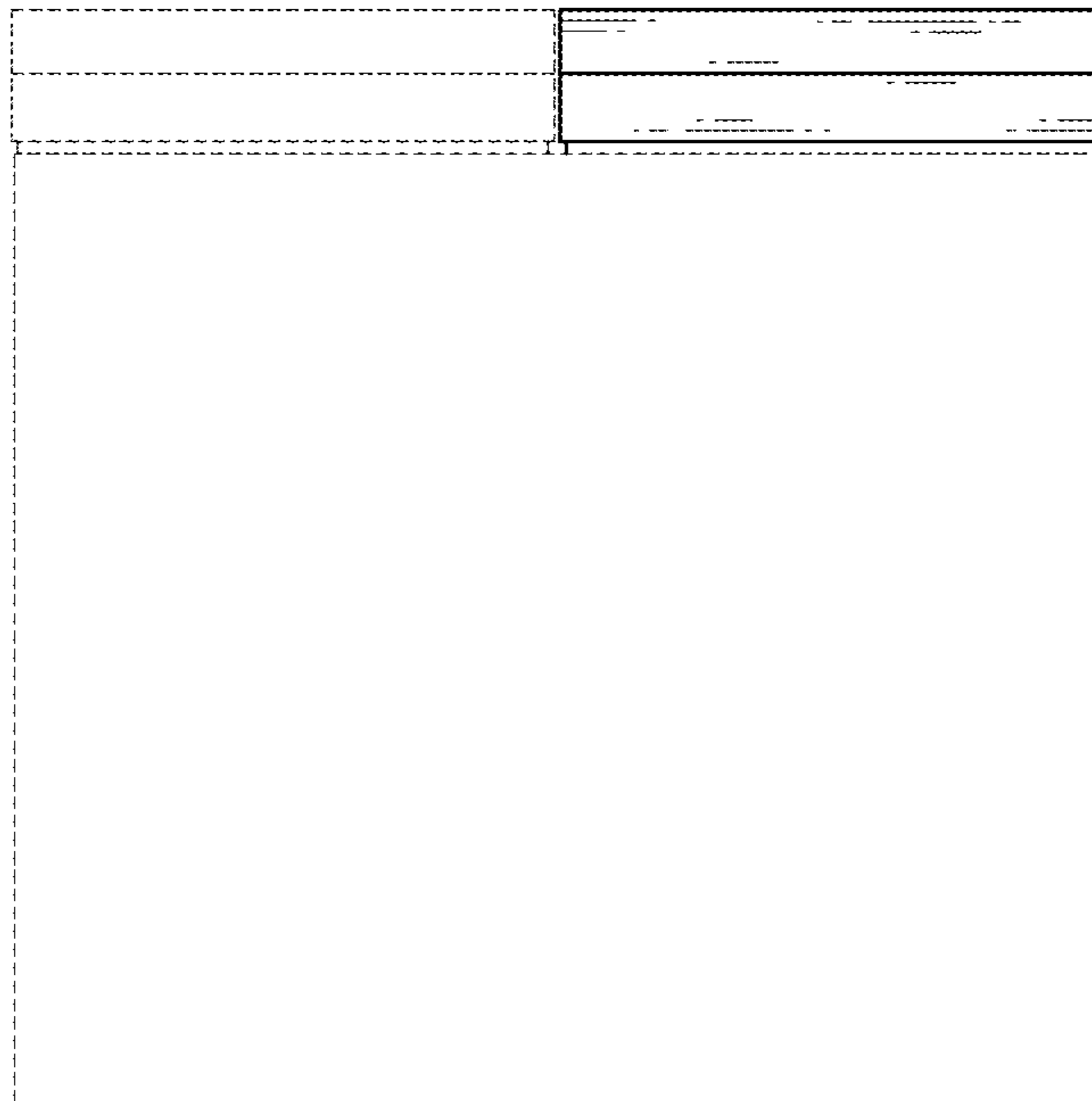

FIG. 8

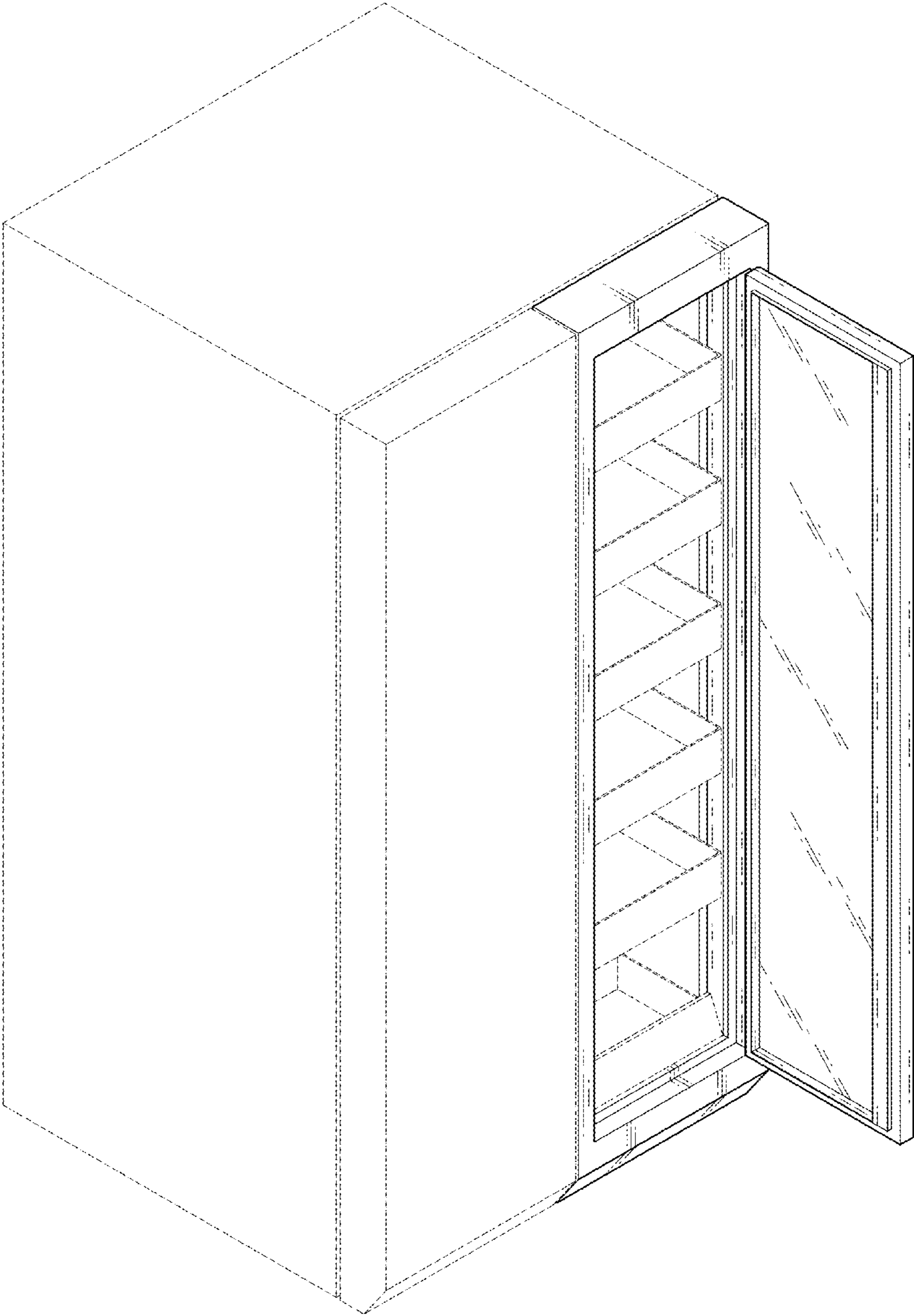

FIG. 9

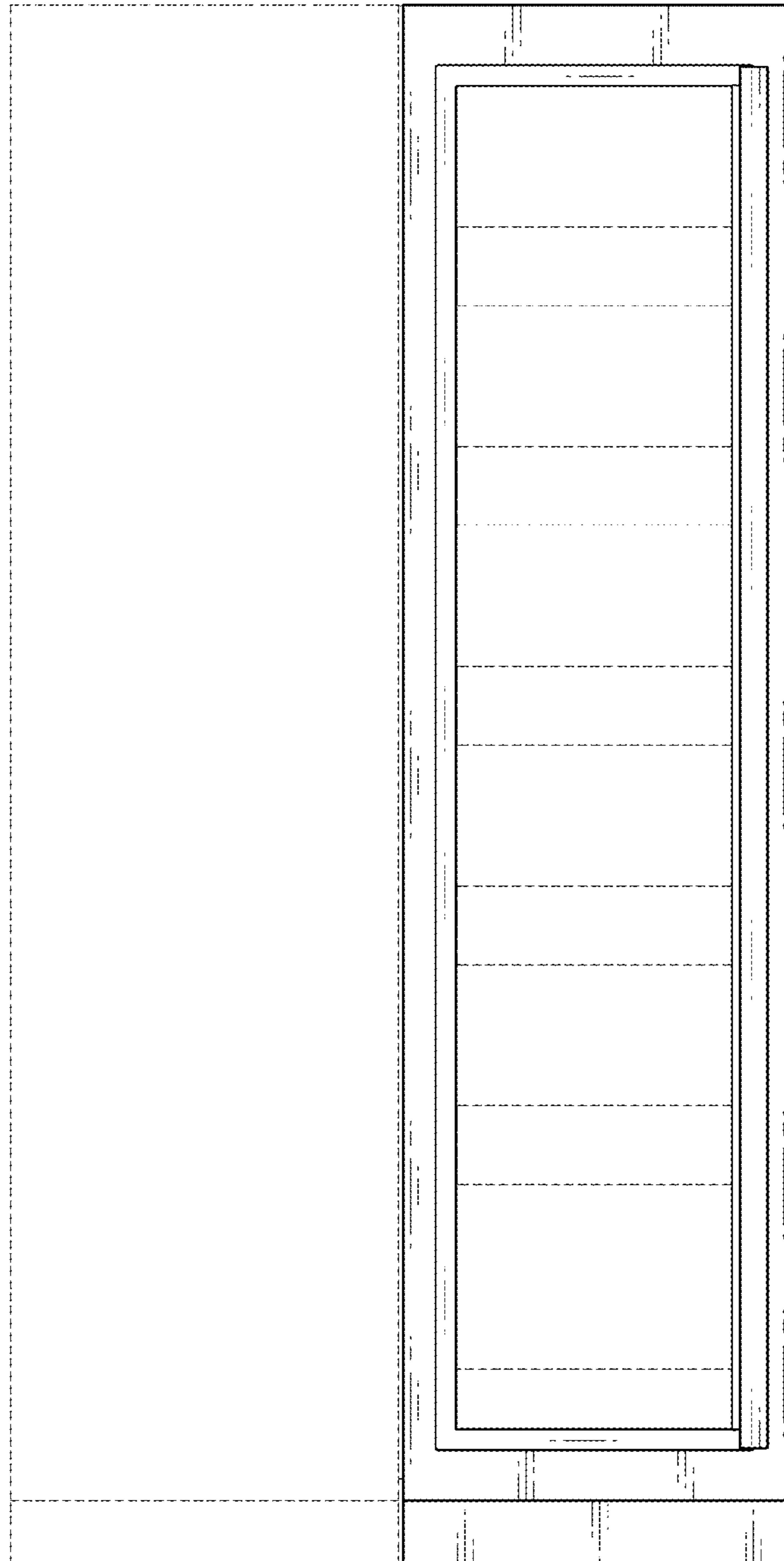

FIG. 10

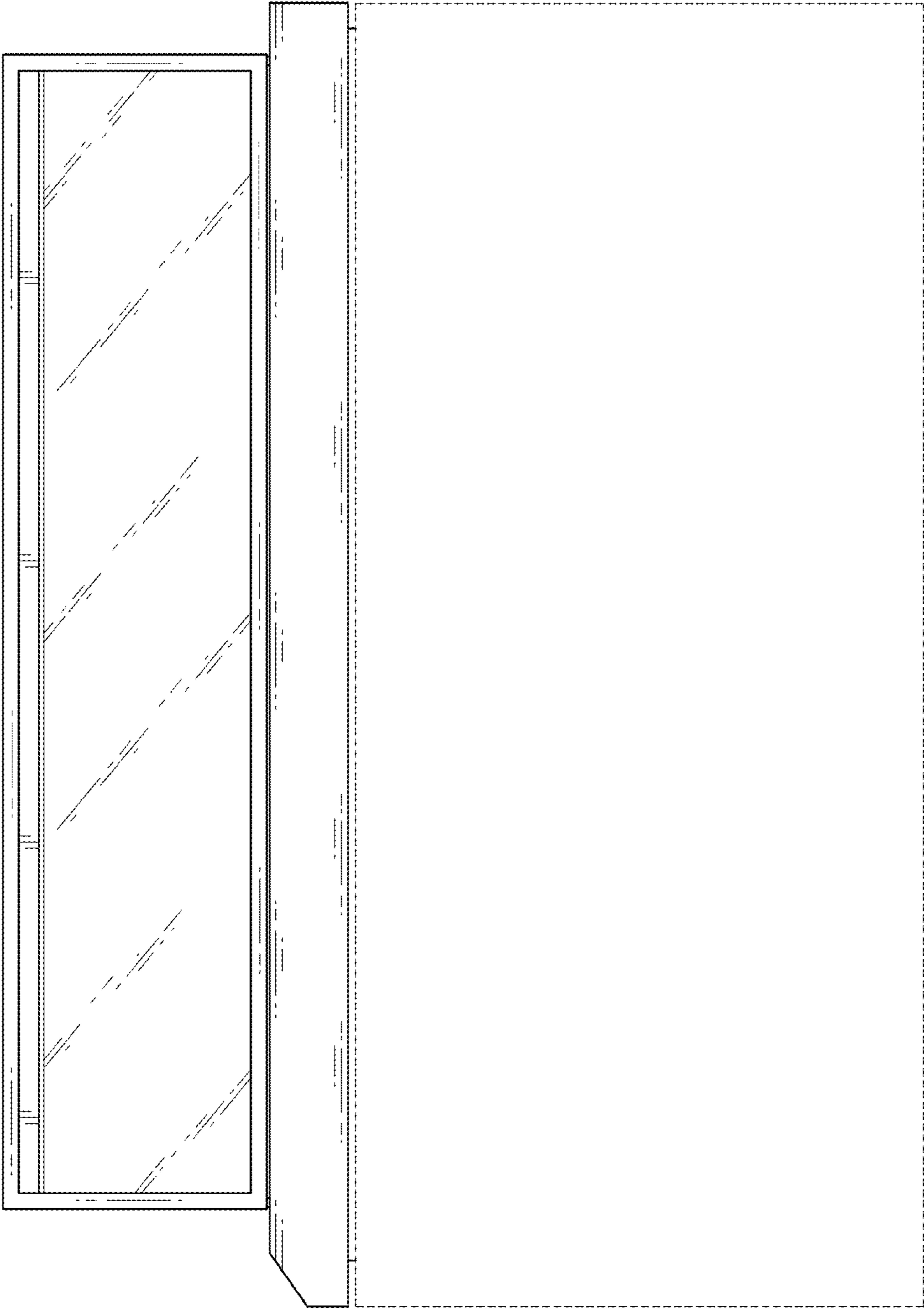

FIG. 11

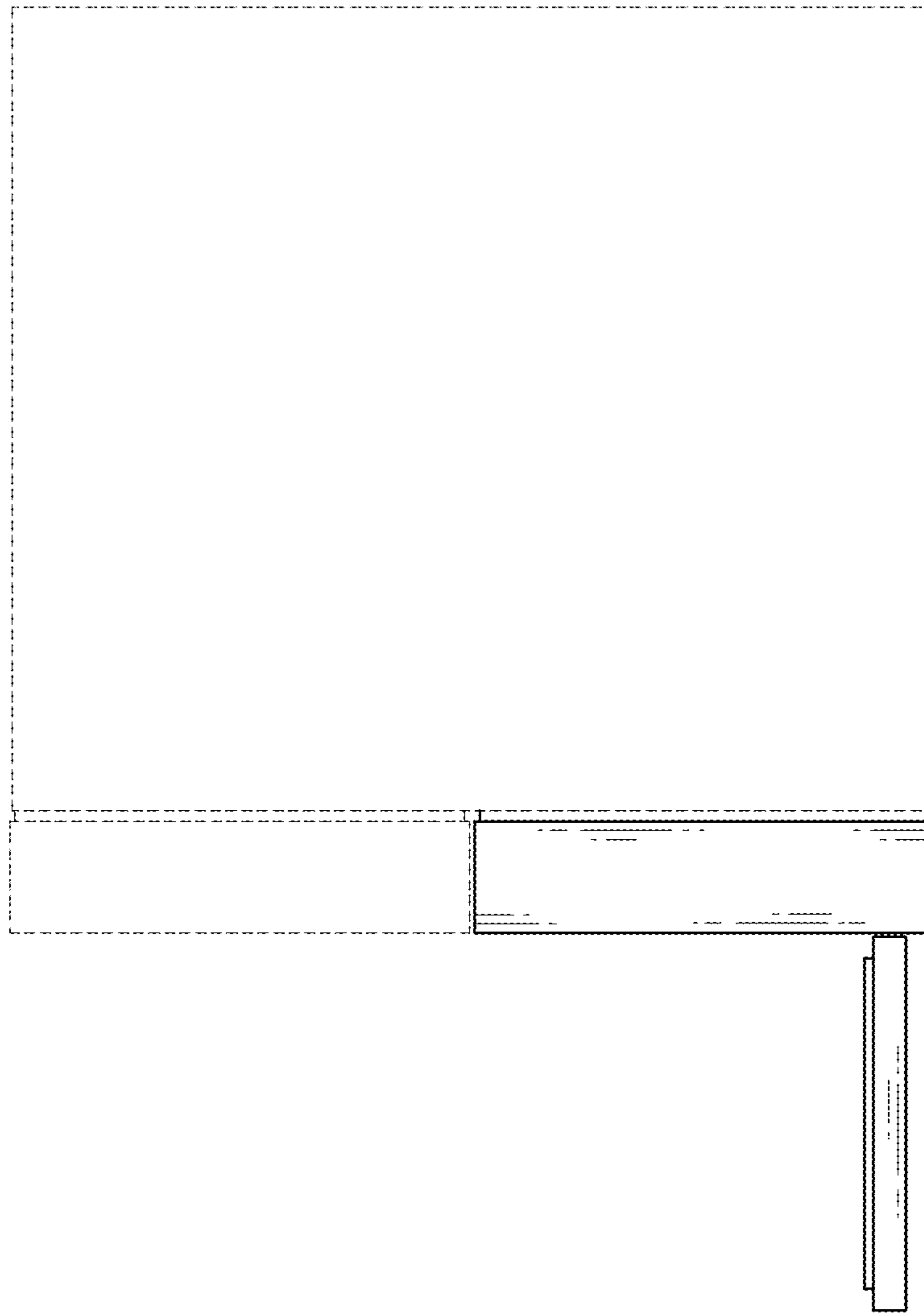

FIG. 12

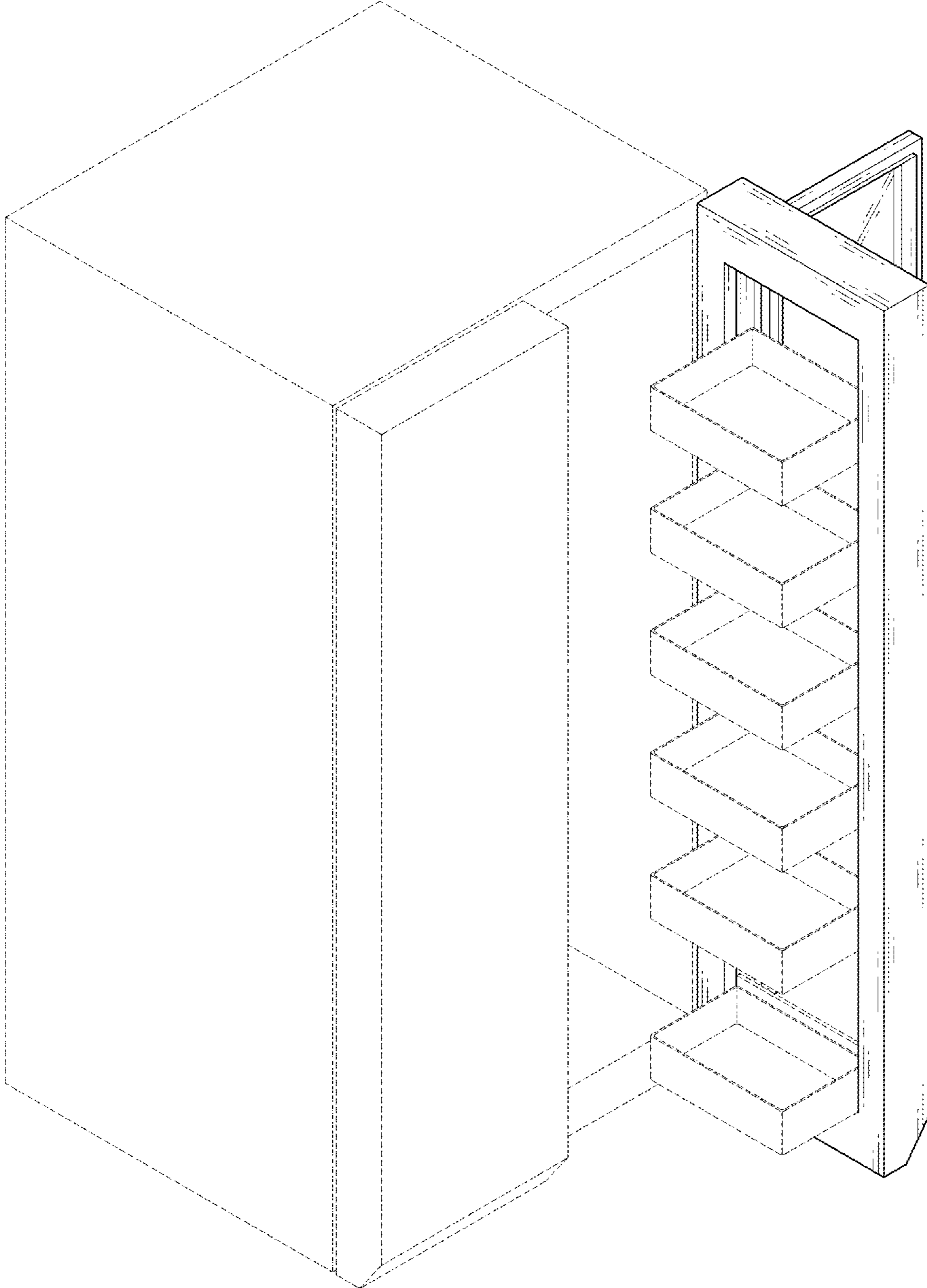

FIG. 13

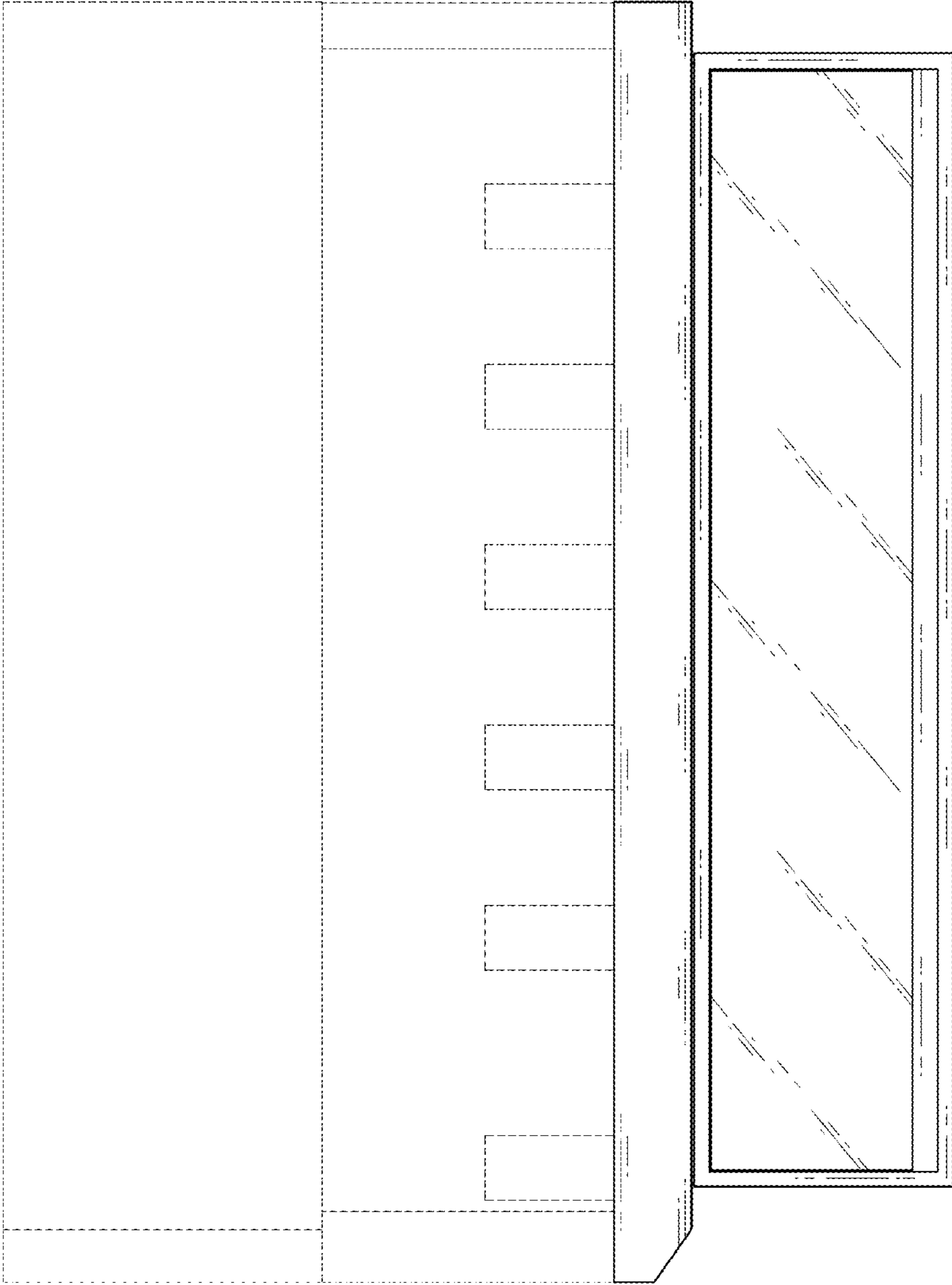

FIG. 14

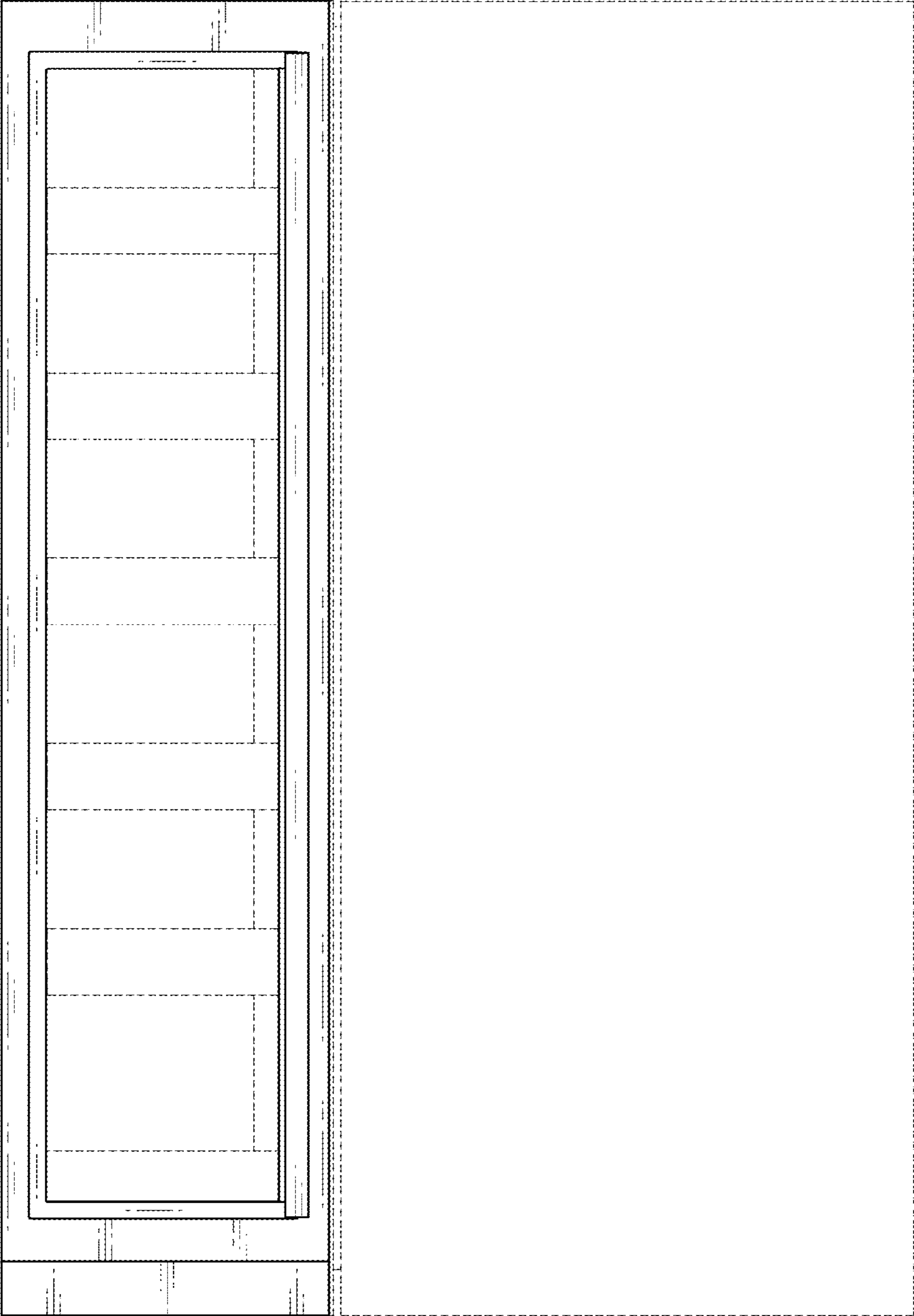

FIG. 15

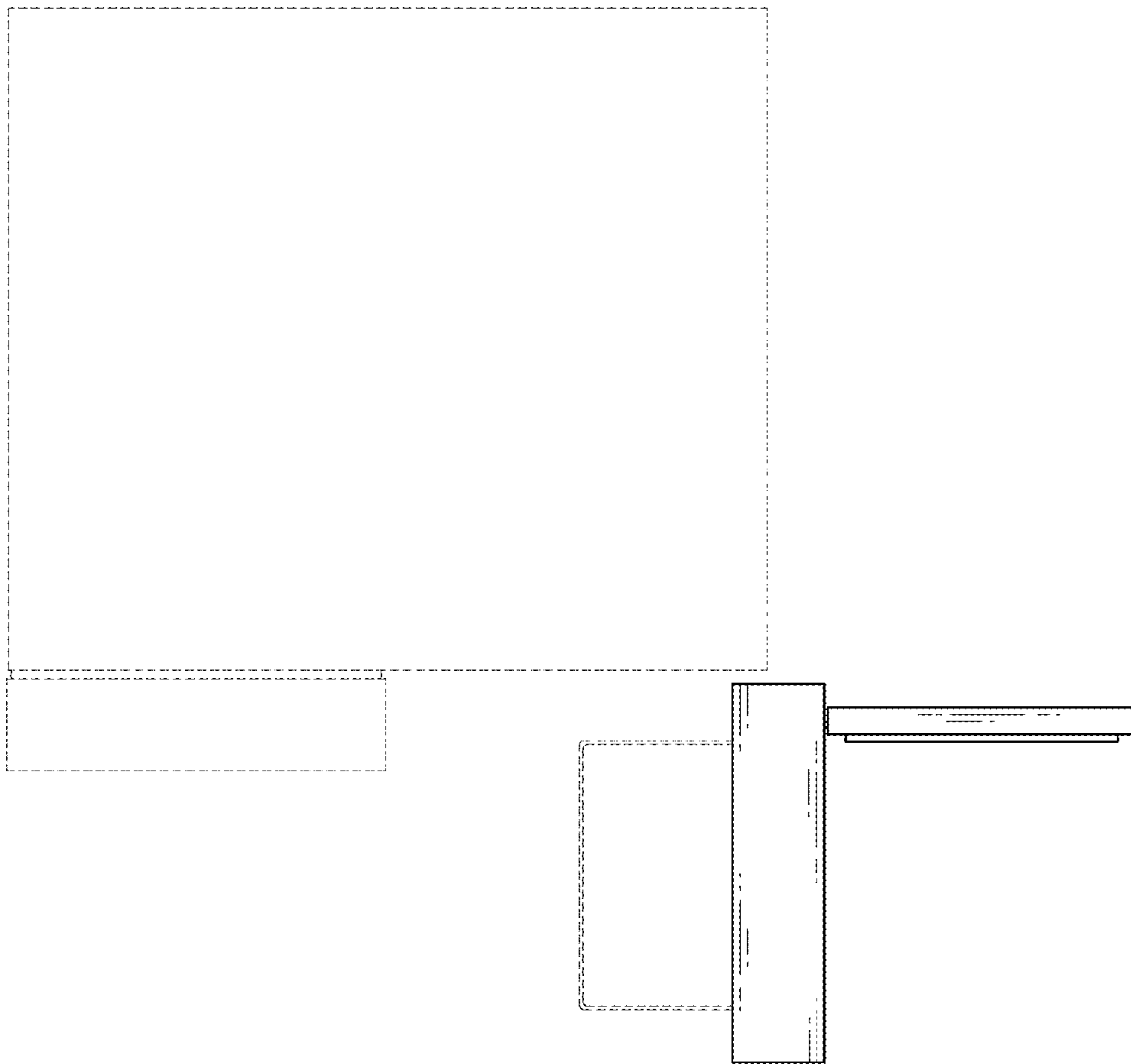

FIG. 16

