



US00D760819S

(12) **United States Design Patent**
Lee et al.

(10) **Patent No.:** **US D760,819 S**
(45) **Date of Patent:** **** Jul. 5, 2016**

(54) **REFRIGERATOR**

D742,941 S * 11/2015 Choi D15/86
D747,368 S * 1/2016 Kim D15/85

(71) Applicant: **LG ELECTRONICS INC.**, Seoul (KR)

* cited by examiner

(72) Inventors: **Hangbok Lee**, Seoul (KR); **Hongsik Kwon**, Seoul (KR); **Minsub Kim**, Seoul (KR); **Jungkyu Son**, Seoul (KR); **Eugene Suh**, Seoul (KR); **Junyi Heo**, Seoul (KR)

Primary Examiner — Daniel Bui

Assistant Examiner — Khawaja Anwar

(74) *Attorney, Agent, or Firm* — Birch, Stewart, Kolasch & Birch, LLP

(73) Assignee: **LG ELECTRONICS INC.**, Seoul (KR)

(**) Term: **14 Years**

(57) **CLAIM**

We claim the ornamental design for a refrigerator, as shown and described.

(21) Appl. No.: **29/522,050**

(22) Filed: **Mar. 27, 2015**

(30) **Foreign Application Priority Data**

DESCRIPTION

Jan. 13, 2015 (KR) 30-2015-0001559

(51) **LOC (10) Cl.** **15-07**

(52) **U.S. Cl.**
USPC **D15/86**

(58) **Field of Classification Search**
USPC D15/79–91
CPC F25D 23/028; F25D 23/02; F25D 25/025;
F25D 23/00; F25D 2323/021; F25D 11/00;
F25D 2323/024; F25D 23/04; F25D 29/00;
F25D 25/02; F25D 25/024; F25D 27/005;
F25D 23/12; F25D 29/005; F25D 17/042;
F25D 2325/021

See application file for complete search history.

FIG. 1 is a perspective view of a refrigerator showing our new design;
FIG. 2 is a front elevation view thereof;
FIG. 3 is a rear elevation view thereof;
FIG. 4 is a left-side elevation view thereof;
FIG. 5 is a right-side elevation view thereof;
FIG. 6 is a top plan view thereof;
FIG. 7 is a bottom plan view thereof;
FIG. 8 is another perspective view thereof, shown in use condition;
FIG. 9 is another perspective view thereof, shown in an open condition; and,
FIG. 10 is another perspective view thereof, shown in another open condition.
The broken lines in the drawing figures are included for the purpose of illustrating environment and form no part of the claimed design.

(56) **References Cited**

U.S. PATENT DOCUMENTS

D739,447 S * 9/2015 Seo D15/86
D742,431 S * 11/2015 Seo D15/86

1 Claim, 9 Drawing Sheets

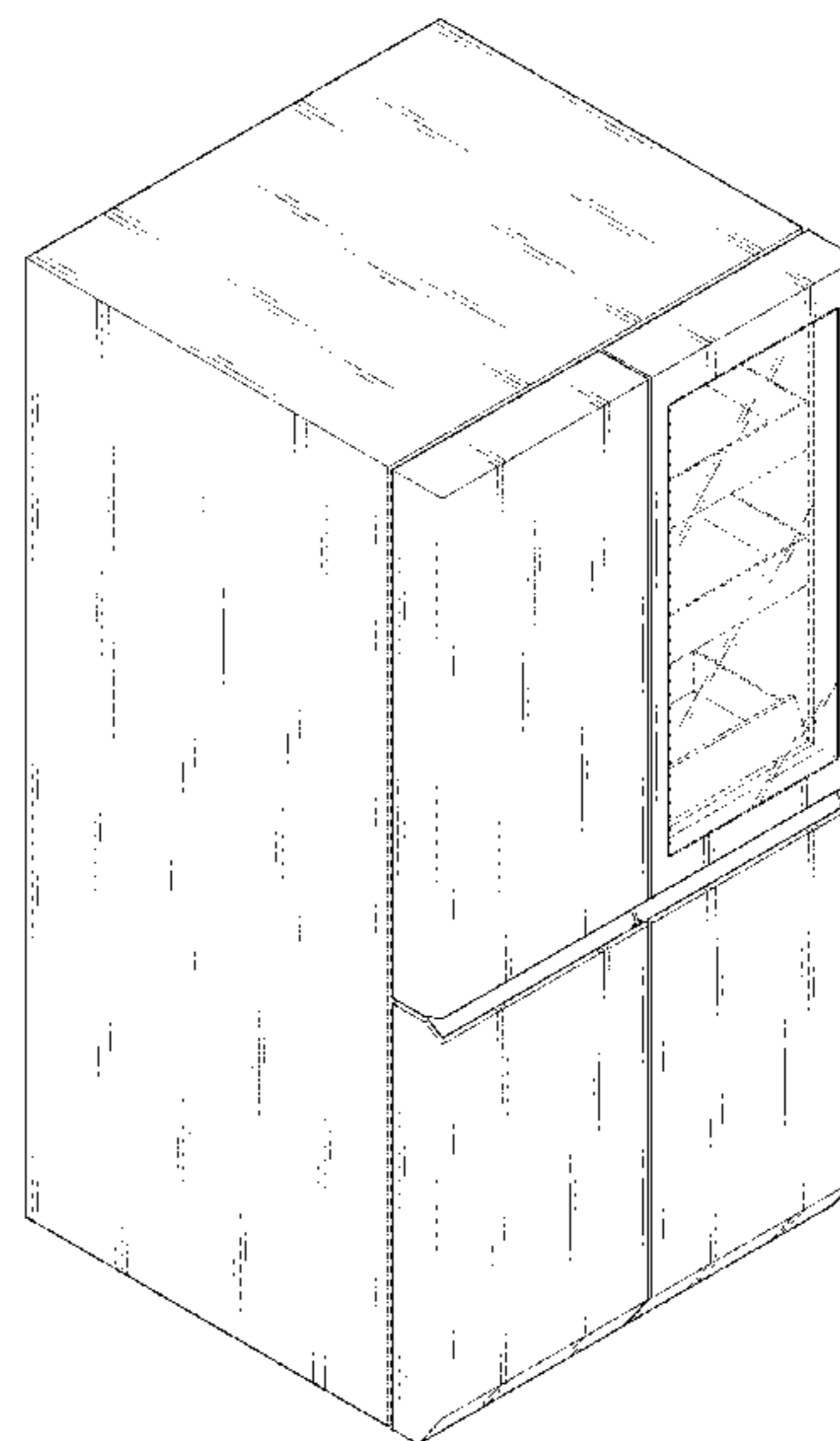
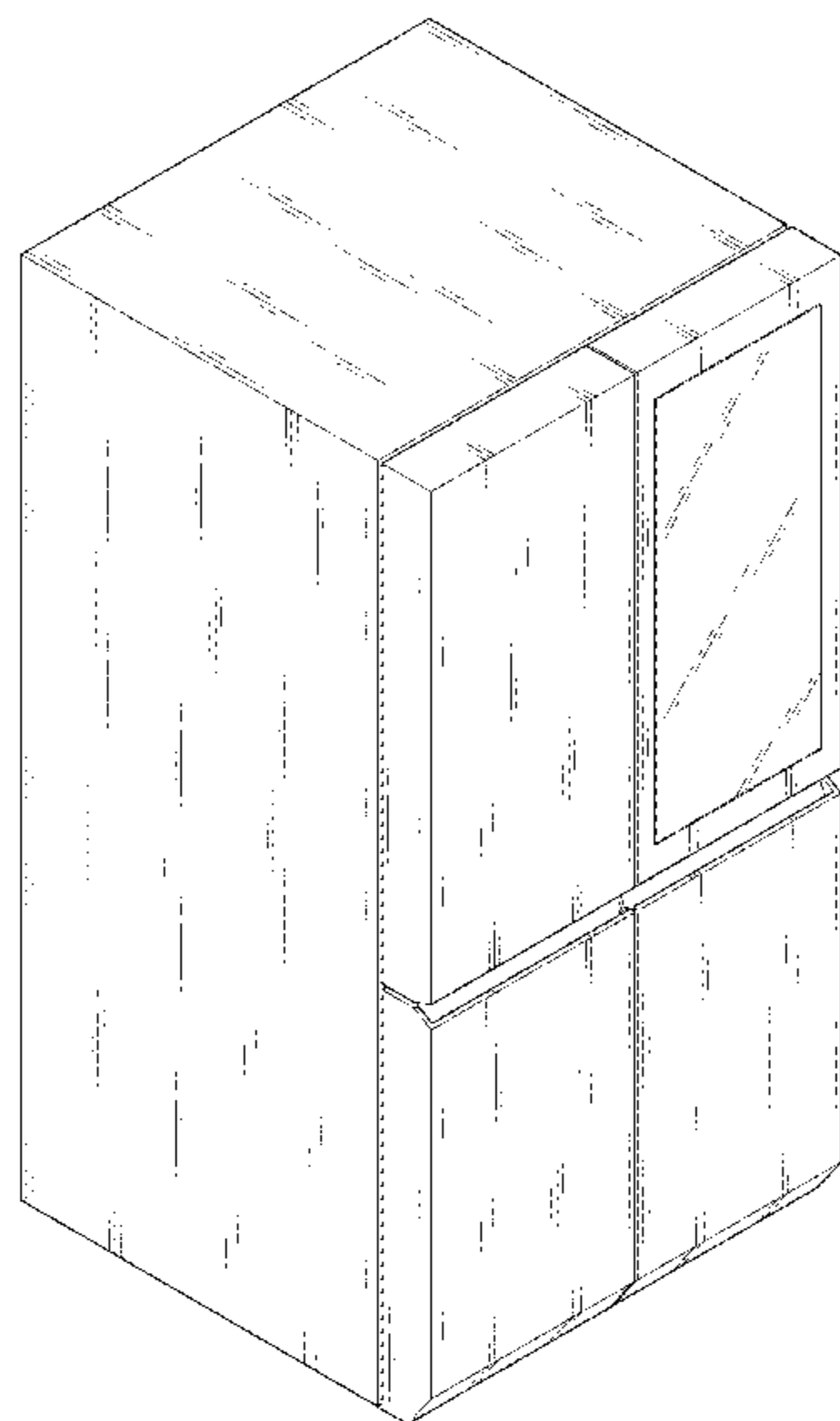

FIG. 1

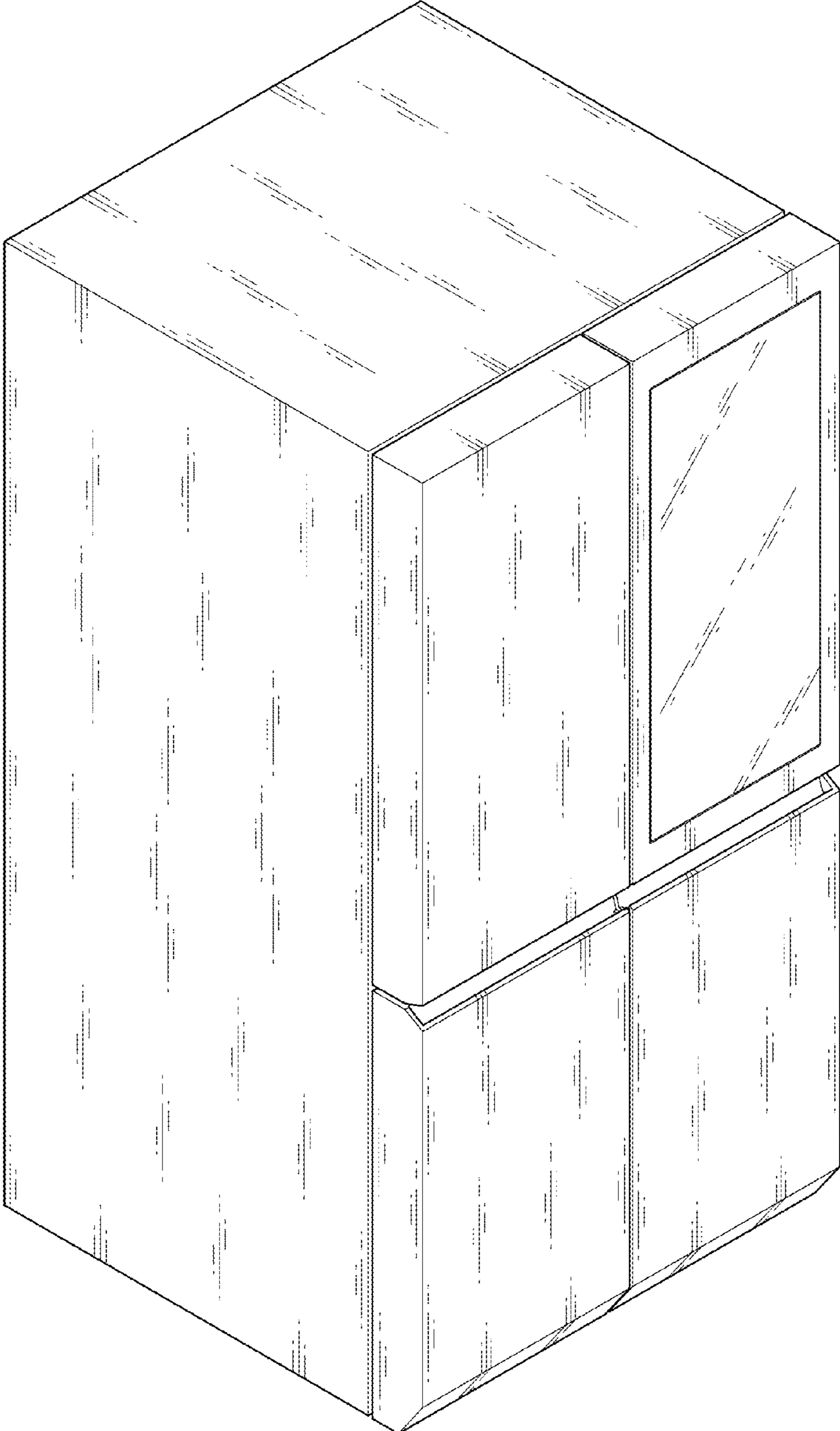

FIG. 2

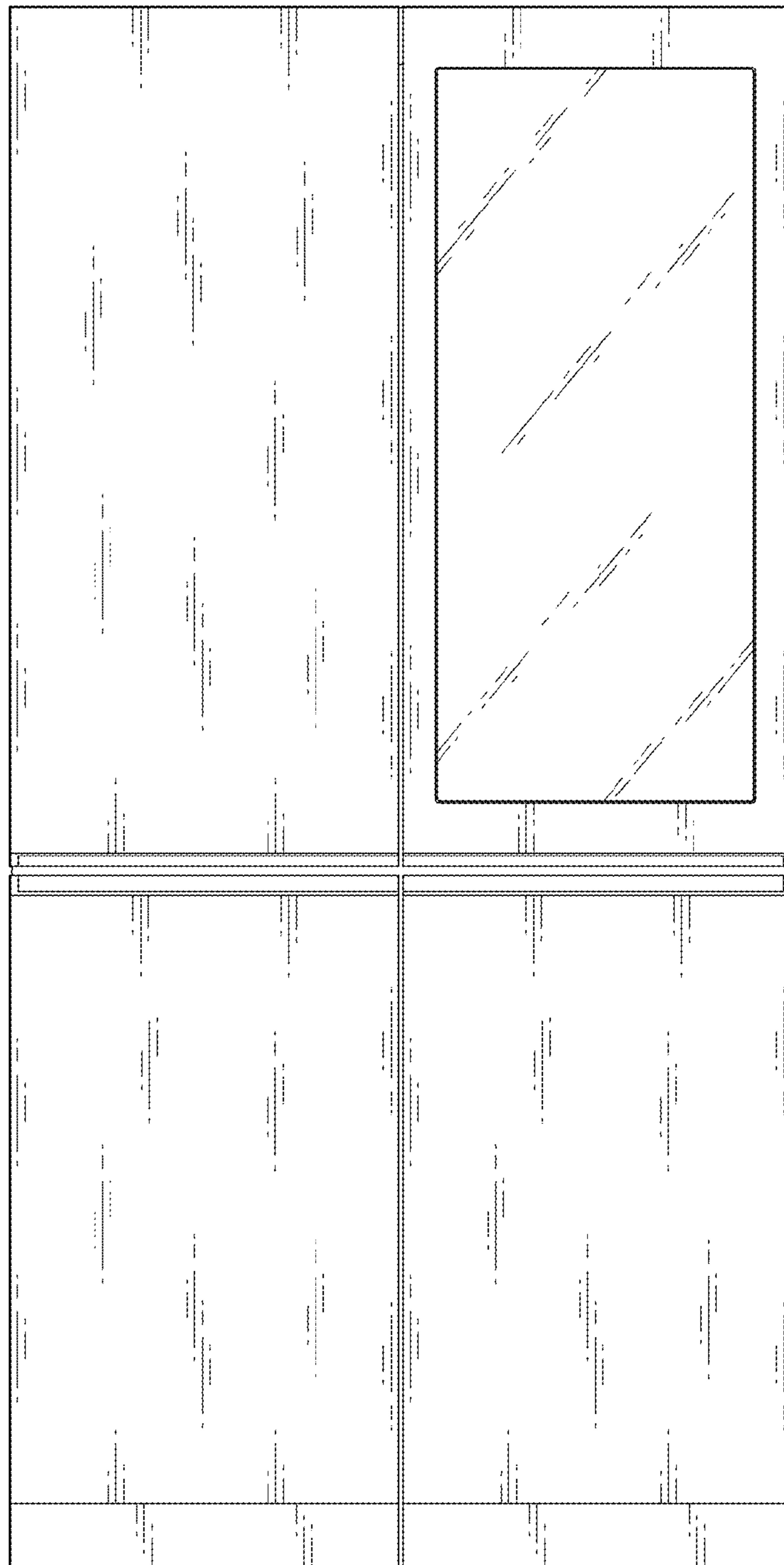

FIG. 3



FIG. 4

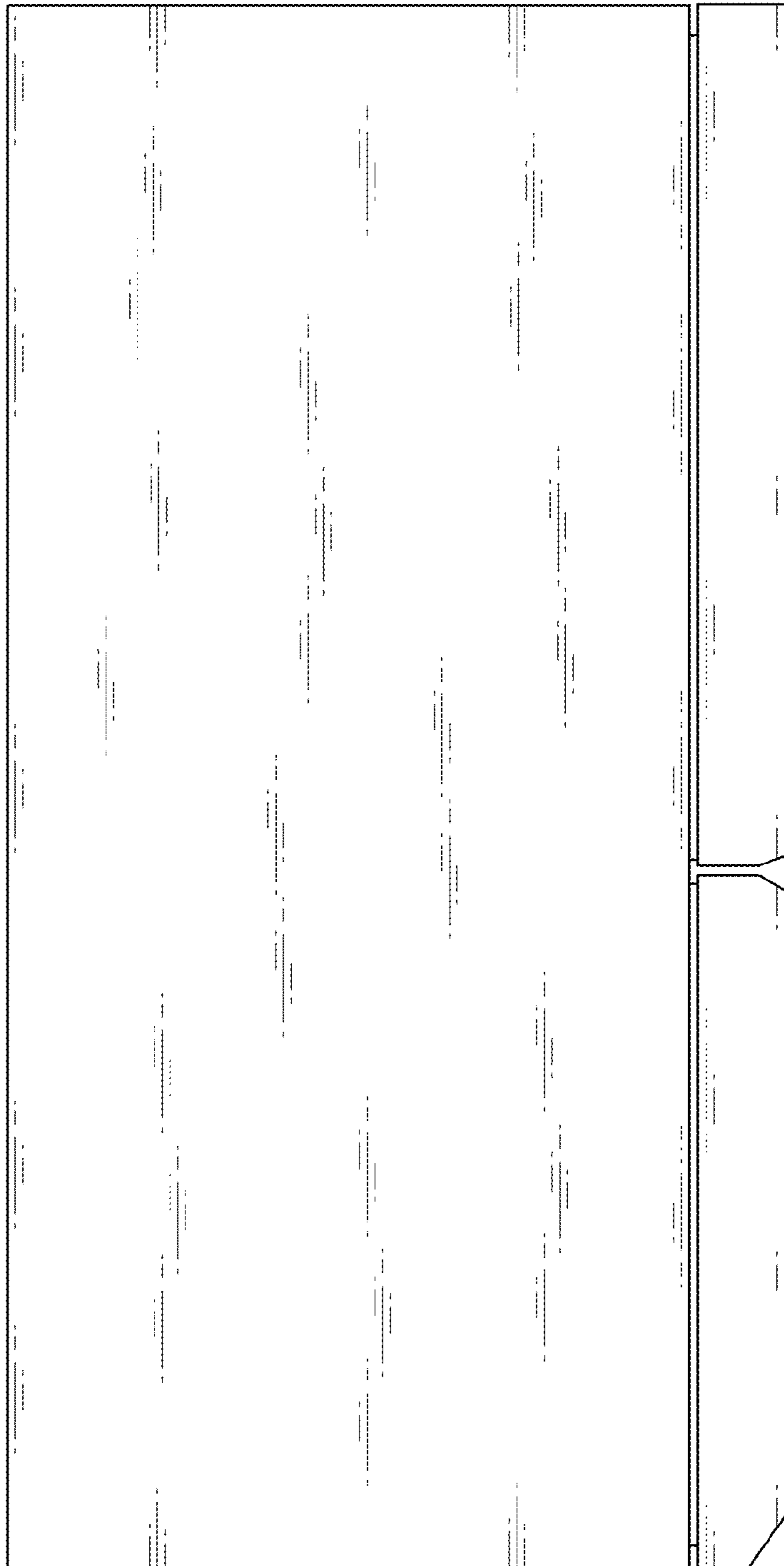

FIG. 5

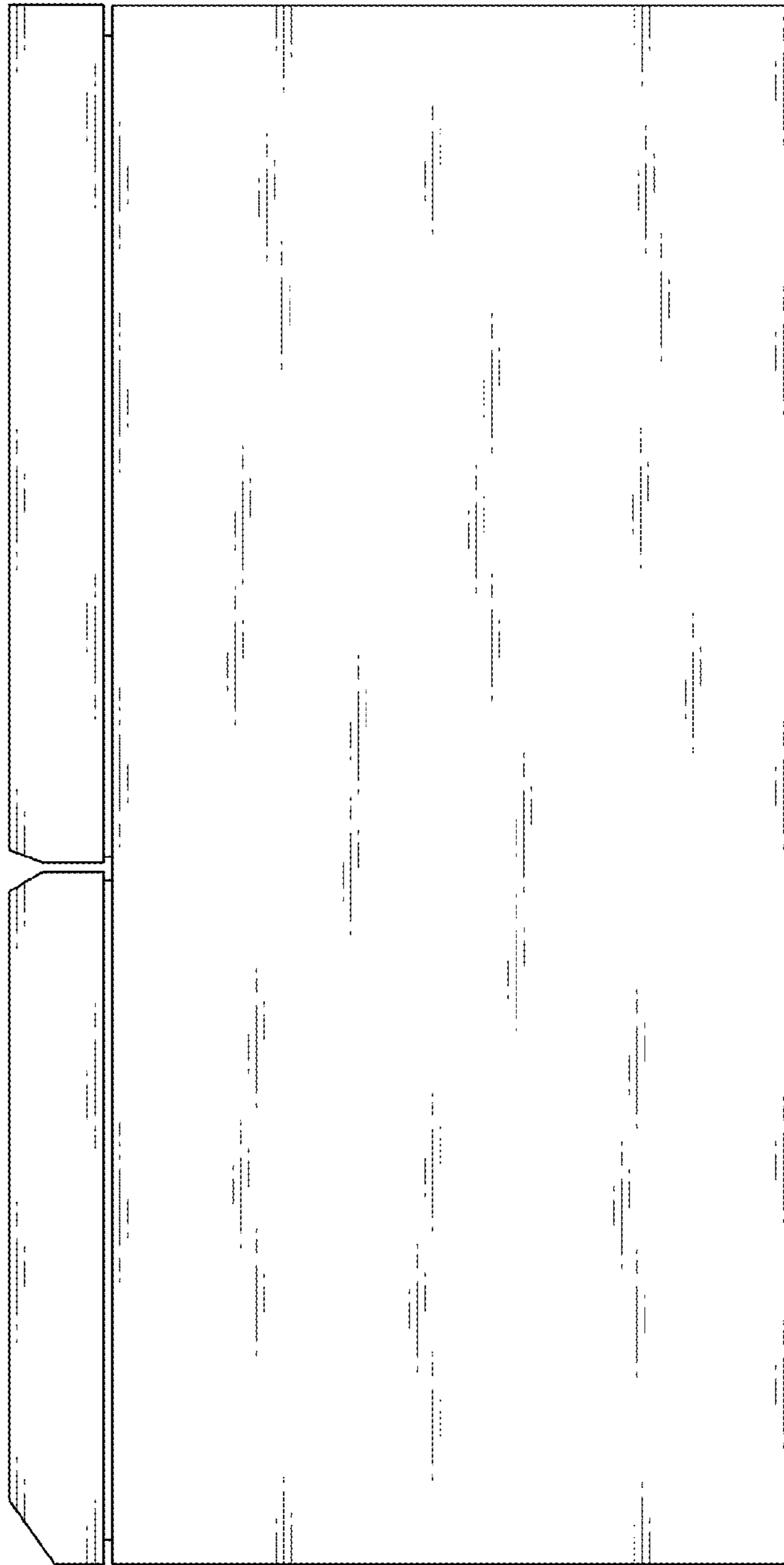

FIG. 6

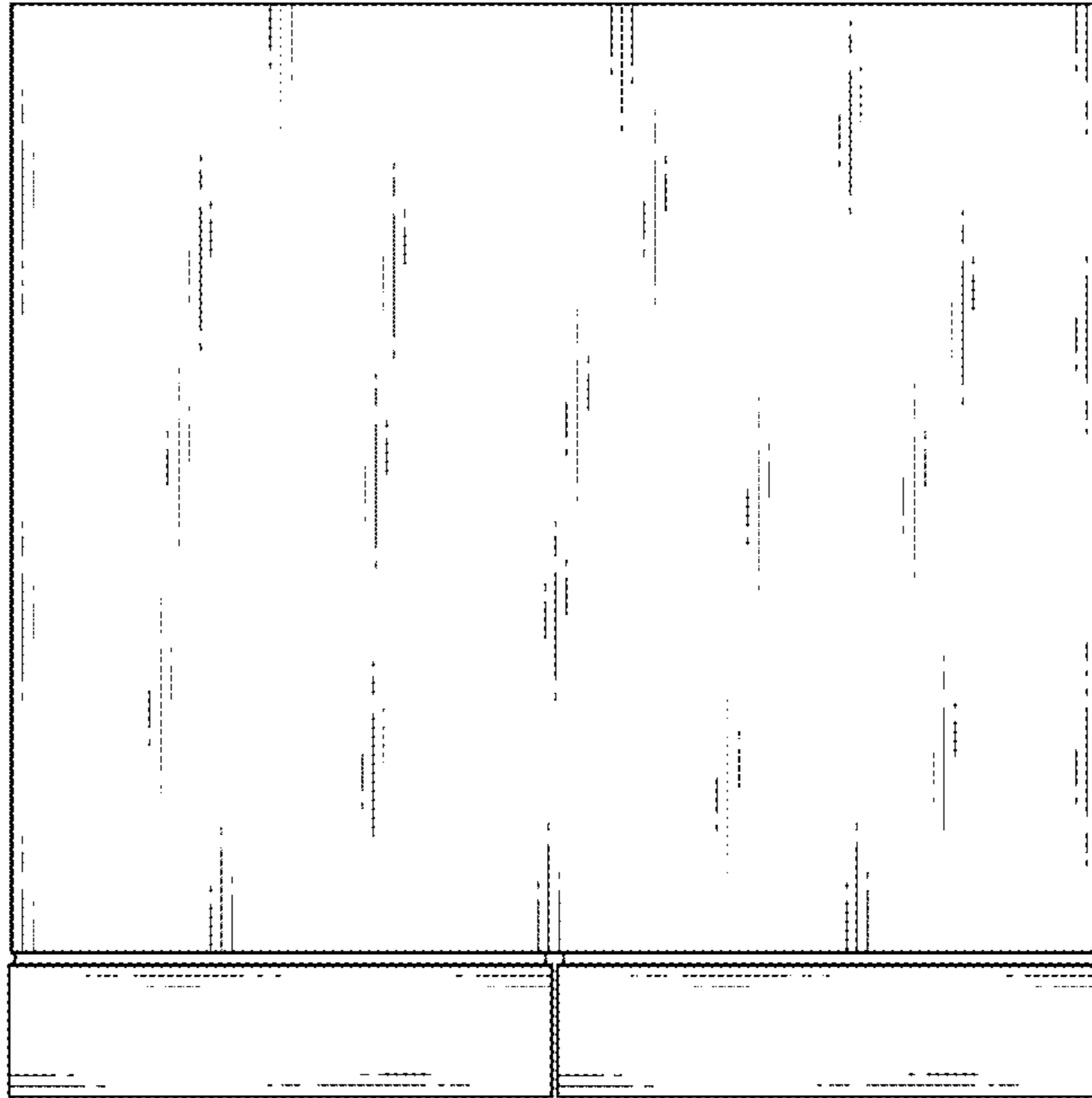

FIG. 7

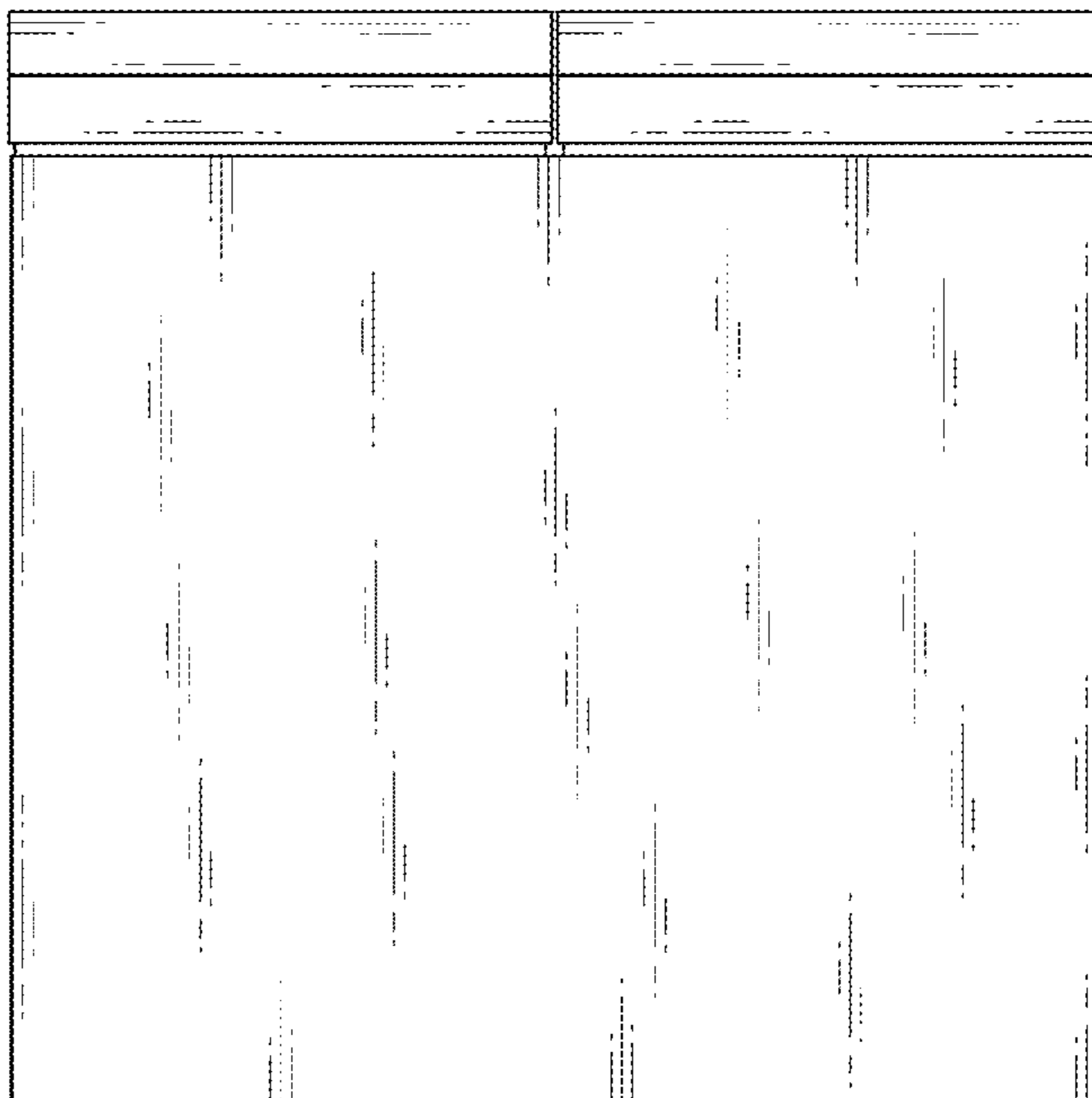

FIG. 8

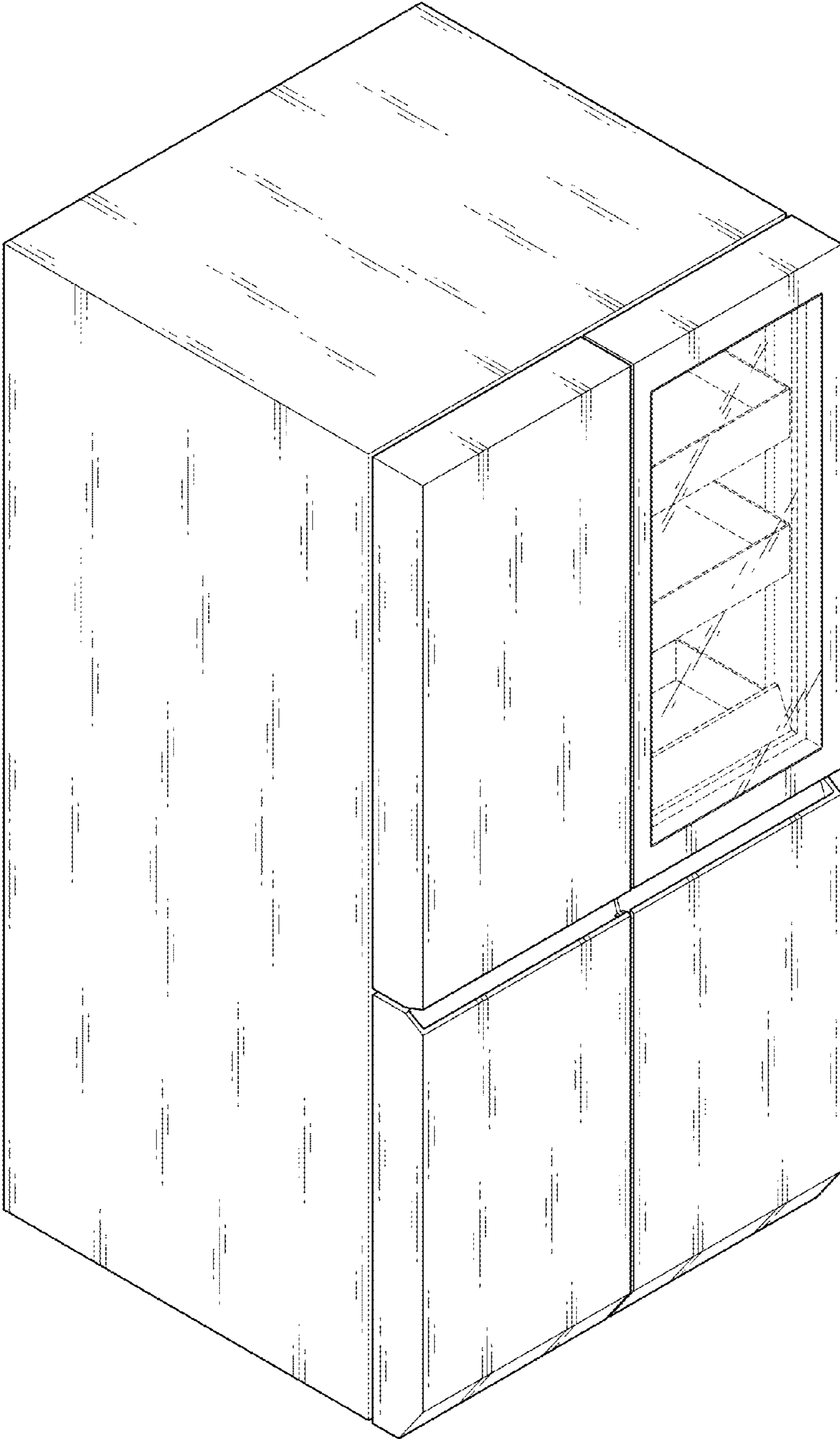

FIG. 9

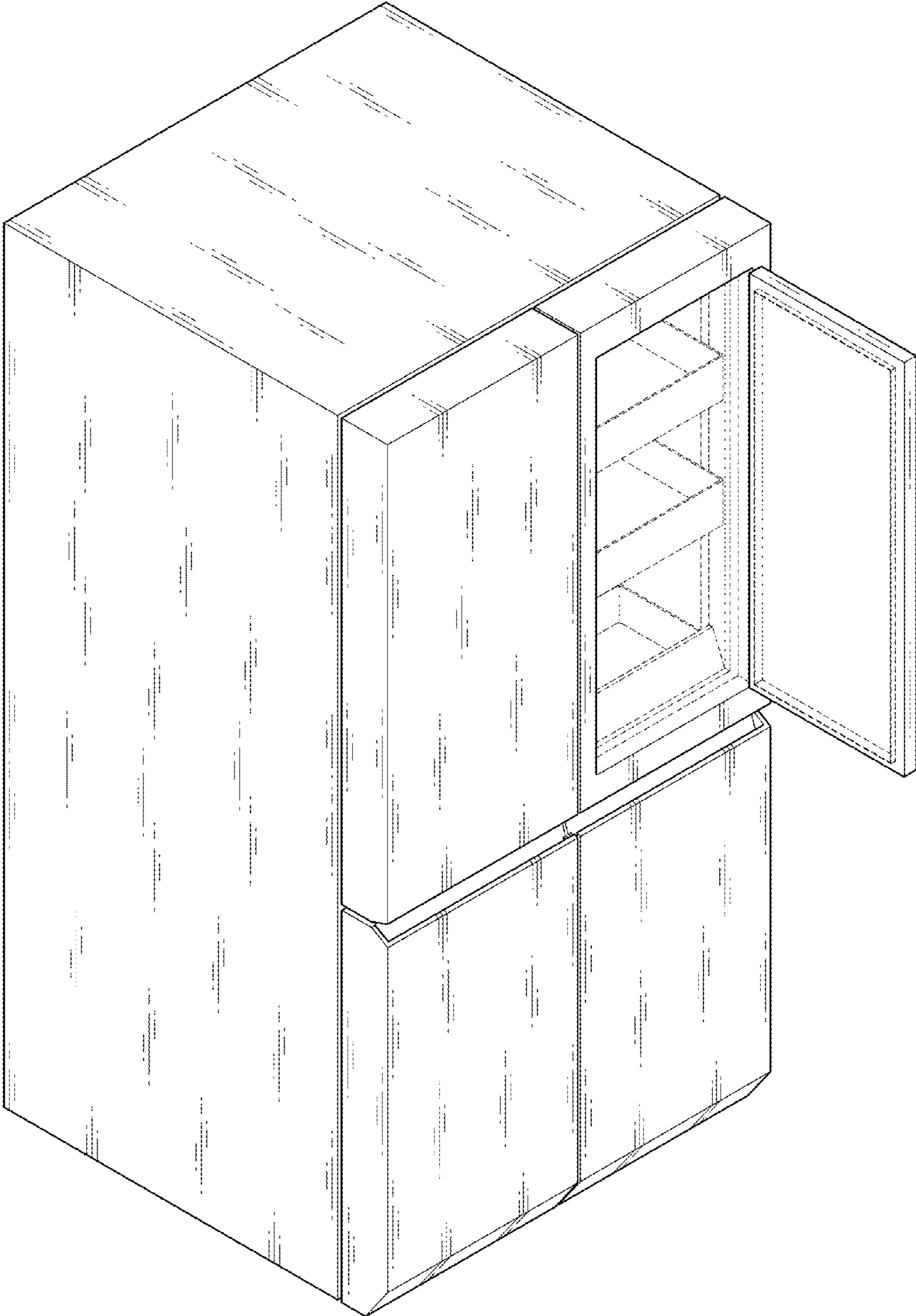

FIG. 10

