

US00D760708S

(12) **United States Design Patent**
Hirst

(10) **Patent No.:** **US D760,708 S**
(45) **Date of Patent:** **** Jul. 5, 2016**

- (54) **MOBILE PHONE HARDSHELL CASE**
- (71) Applicant: **Marvelpress Limited**, Sheffield (GB)
- (72) Inventor: **Paul Hirst**, Sheffield (GB)
- (**) Term: **14 Years**
- (21) Appl. No.: **29/490,699**
- (22) Filed: **May 13, 2014**
- (51) **LOC (10) Cl.** **14-03**
- (52) **U.S. Cl.**
USPC **D14/250**
- (58) **Field of Classification Search**
USPC D14/238.1, 250, 440, 203.3–203.7, 217,
D14/240, 248, 251–253, 447, 496, 143, 189,
D14/203.2; D3/201, 218, 247, 269, 273,
D3/301, 303; D13/103, 107–108, 119
CPC A45C 1/06; A45C 11/00; A45C 13/02;
A45C 2011/002; A45F 2005/026; A45F
2200/0525; A45F 2200/0516; H04B 1/3888;
H04M 1/0283; H04M 1/0202
See application file for complete search history.

- D696,256 S * 12/2013 Piedra D14/440
- D698,785 S * 2/2014 Canizares D14/341
- D702,673 S * 4/2014 Murchison D14/250
- D710,349 S * 8/2014 Han D14/341
- D711,861 S * 8/2014 Mei D14/250
- D712,393 S * 9/2014 Kim D14/250

(Continued)

Primary Examiner — Carla Jobe Wright

(74) *Attorney, Agent, or Firm* — B. Craig Killough;
Barnwell Whaley Patterson & Helms

(57) **CLAIM**

The ornamental design for a mobile phone hardshell case, substantially as shown and described.

DESCRIPTION

FIG. 1 is a front perspective view of a mobile phone hardshell case showing the new design;
 FIG. 2 is front elevation of the case shown in FIG. 1;
 FIG. 3 is rear view of the case in relation to FIG. 2;
 FIG. 4 is a left side view of the case in relation to FIG. 2;
 FIG. 5 is a right side view of the case in relation to FIG. 2;
 FIG. 6 is a top view of the case in relation to FIG. 2;
 FIG. 7 is a bottom view of the case in relation to FIG. 2;
 FIG. 8 is a front perspective view of the case in an open position;
 FIG. 9 is a front view of the case in an open position;
 FIG. 10 is a back view of the case in an open position;
 FIG. 11 is a left side view of the case in relation to FIG. 9;
 FIG. 12 is a right side view of the case in relation to FIG. 9;
 FIG. 13 is a top view of the case in relation to FIG. 9; and,
 FIG. 14 is a bottom view of the case in relation to FIG. 9.
 The broken lines depict stitching which is part of the claimed design.

(56) **References Cited**

U.S. PATENT DOCUMENTS

- D241,381 S * 9/1976 Garnier 150/135
- D414,033 S * 9/1999 Rohm D3/201
- D600,699 S * 9/2009 Johnston D14/440
- D641,348 S * 7/2011 Kim D14/250
- D652,829 S * 1/2012 Kim D14/250
- D657,354 S * 4/2012 Kim D14/250
- D669,480 S * 10/2012 Piedra D14/440
- D678,884 S * 3/2013 Phillips D14/440
- D681,620 S * 5/2013 Huskinson D14/250

1 Claim, 10 Drawing Sheets



US D760,708 S

Page 2

(56)

References Cited

U.S. PATENT DOCUMENTS

D721,064 S * 1/2015 Sun D14/250
D722,059 S * 2/2015 Hirst D14/440
D724,092 S * 3/2015 Zangari D14/440
D729,522 S * 5/2015 Kim D3/218

2003/0150756 A1* 8/2003 Kajiya A45C 13/02
206/320
2012/0043234 A1* 2/2012 Westrup A45C 3/02
206/320
2012/0244920 A1* 9/2012 Lee H04B 1/3888
455/575.8

* cited by examiner

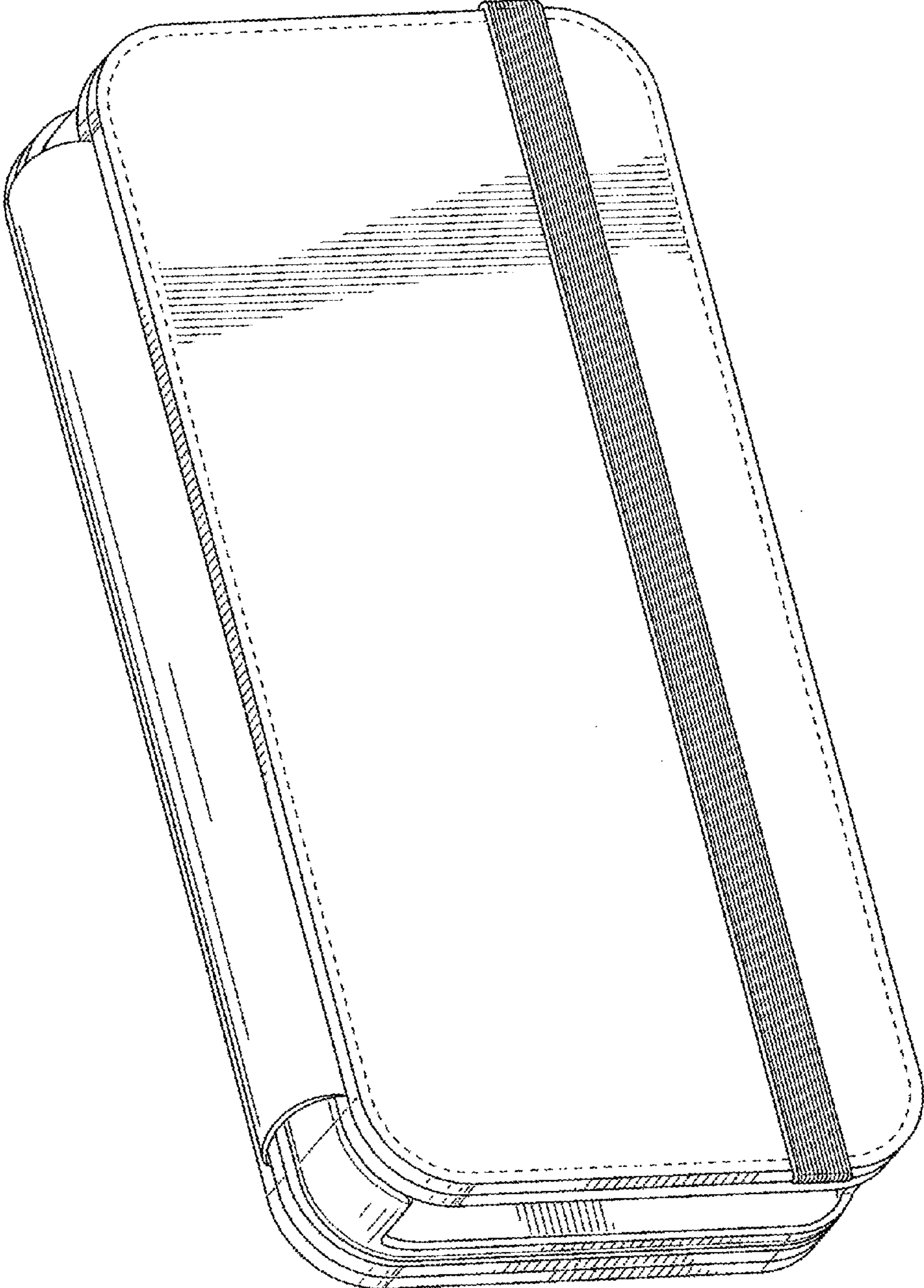

FIG. 1

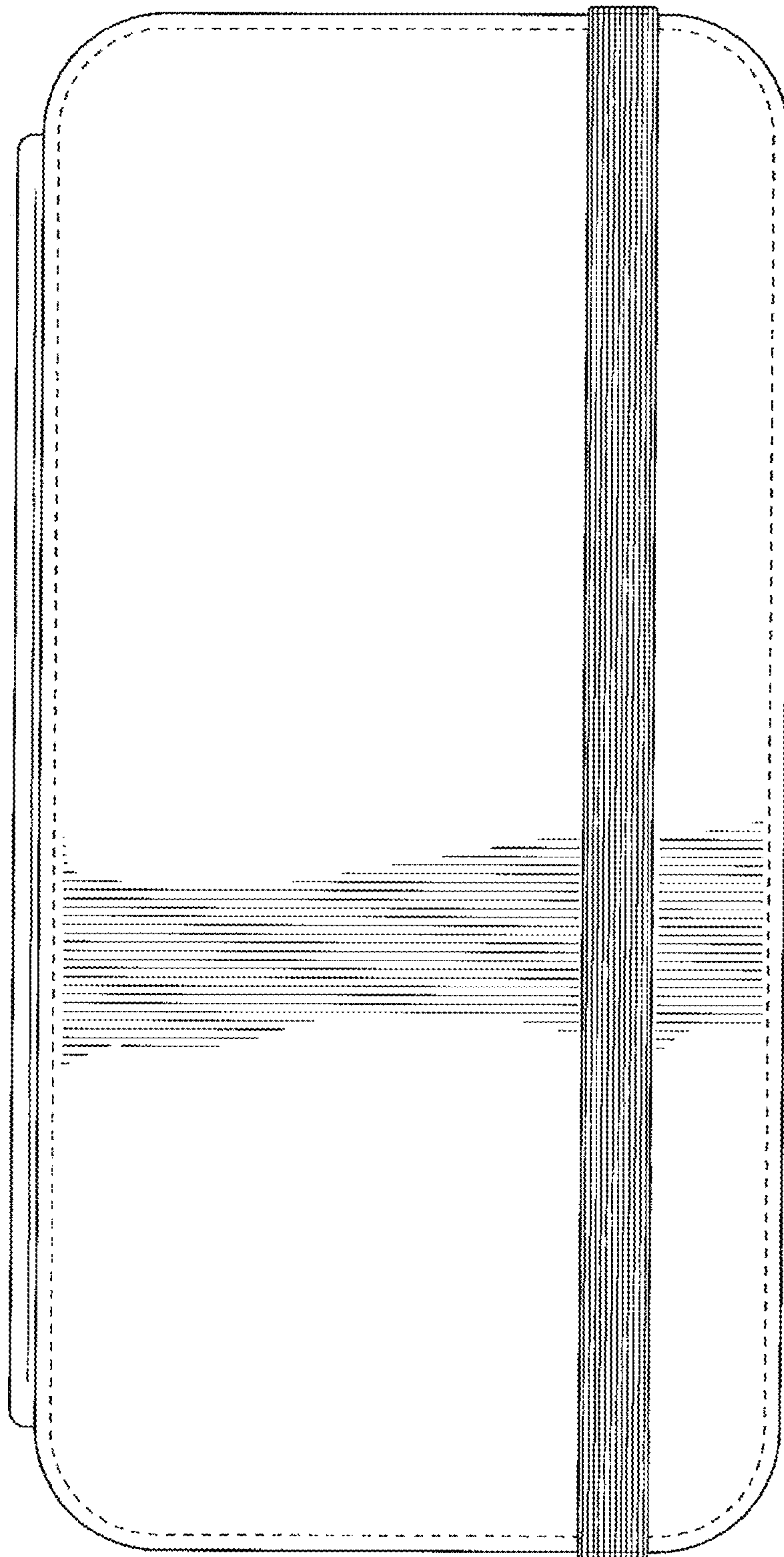

FIG. 2

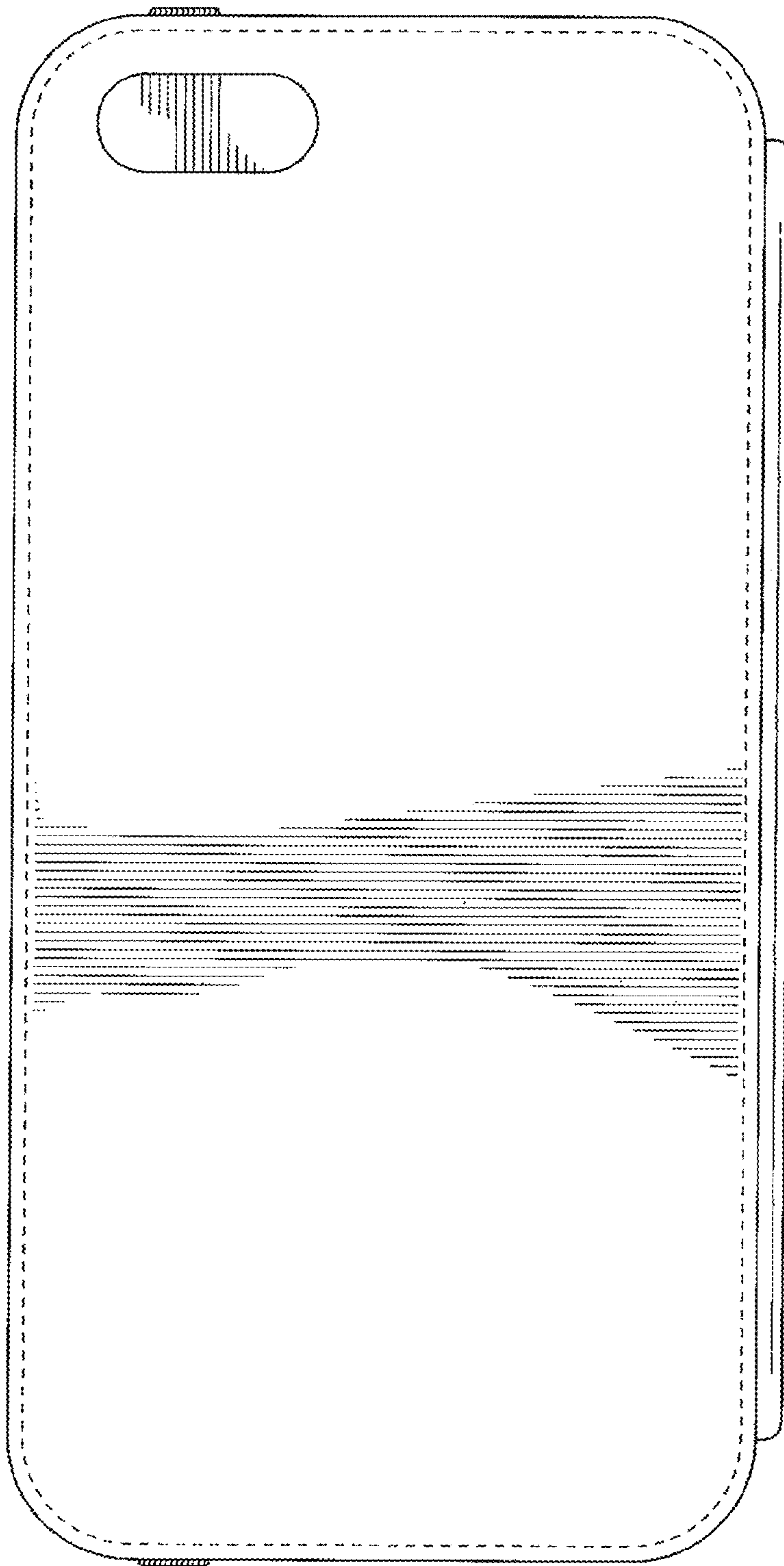

FIG. 3

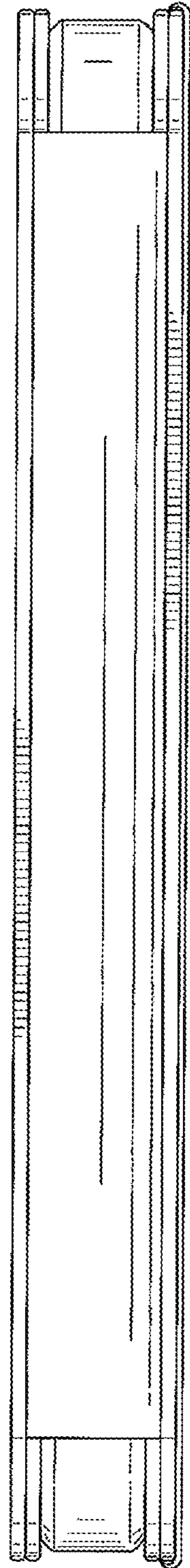

FIG. 4

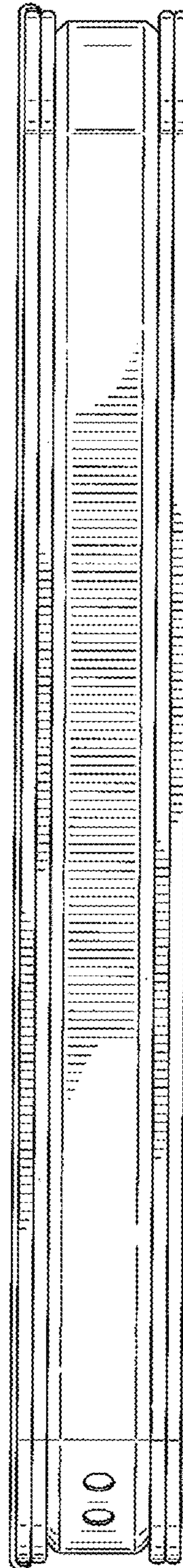

FIG. 5

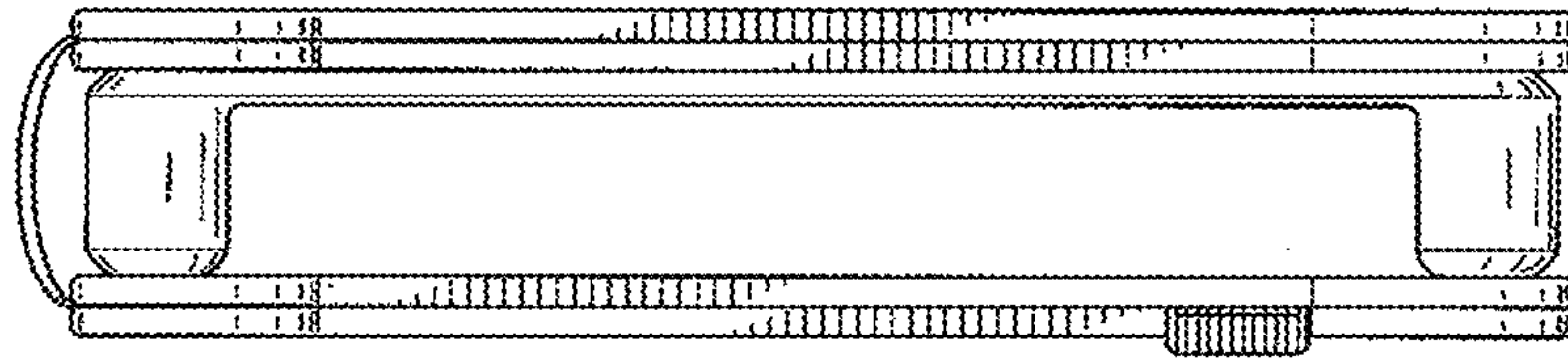

FIG. 6

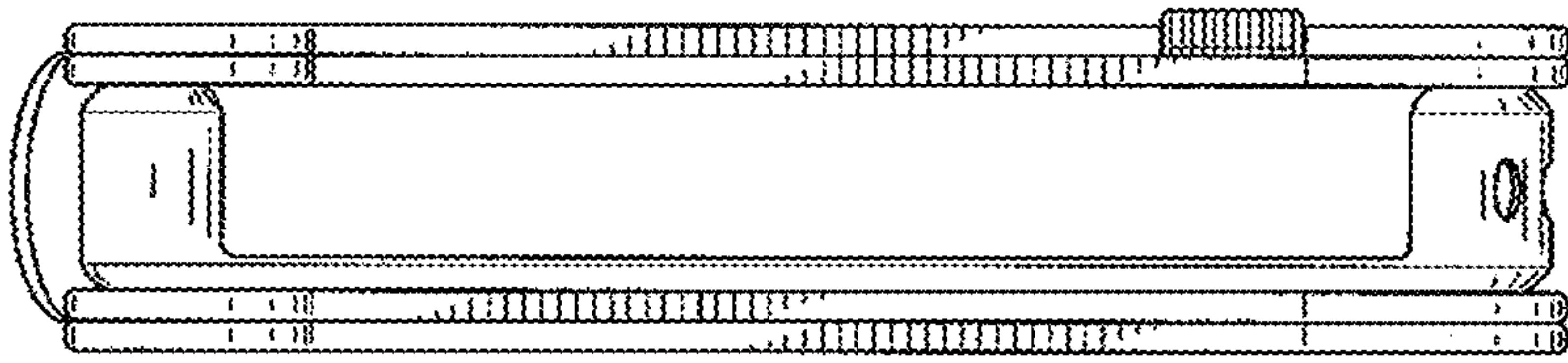

FIG. 7

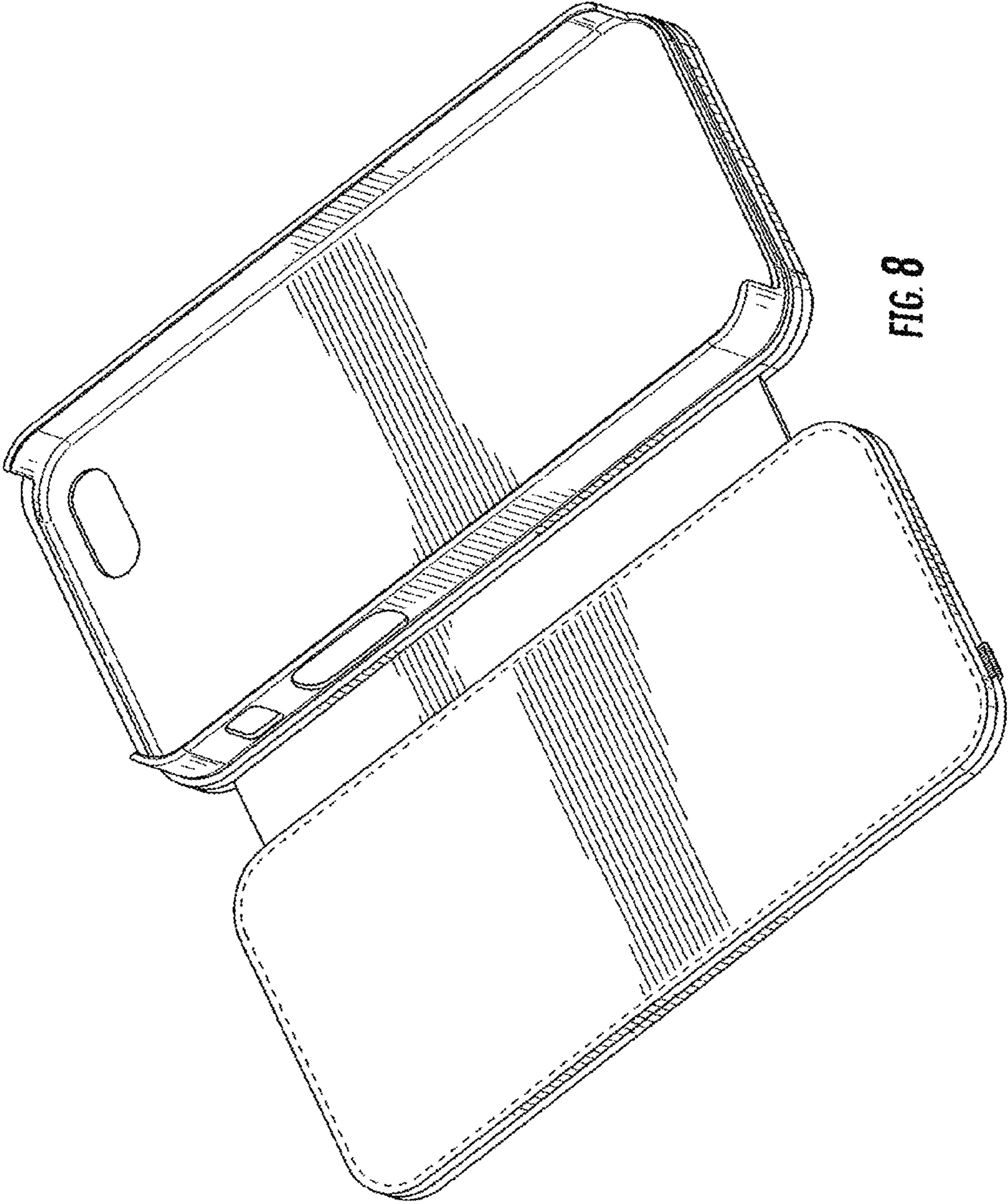

FIG. 8

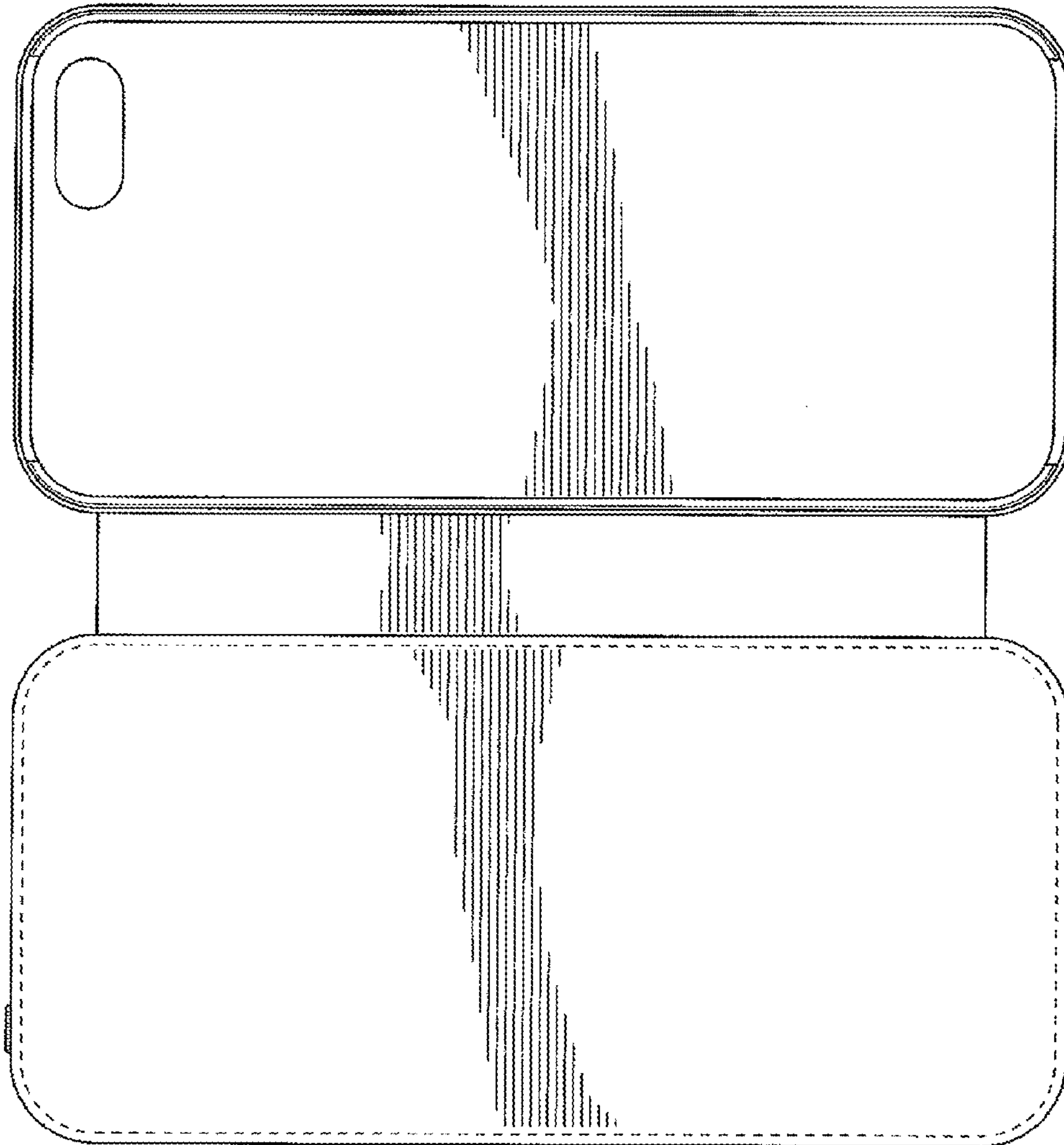

FIG. 9

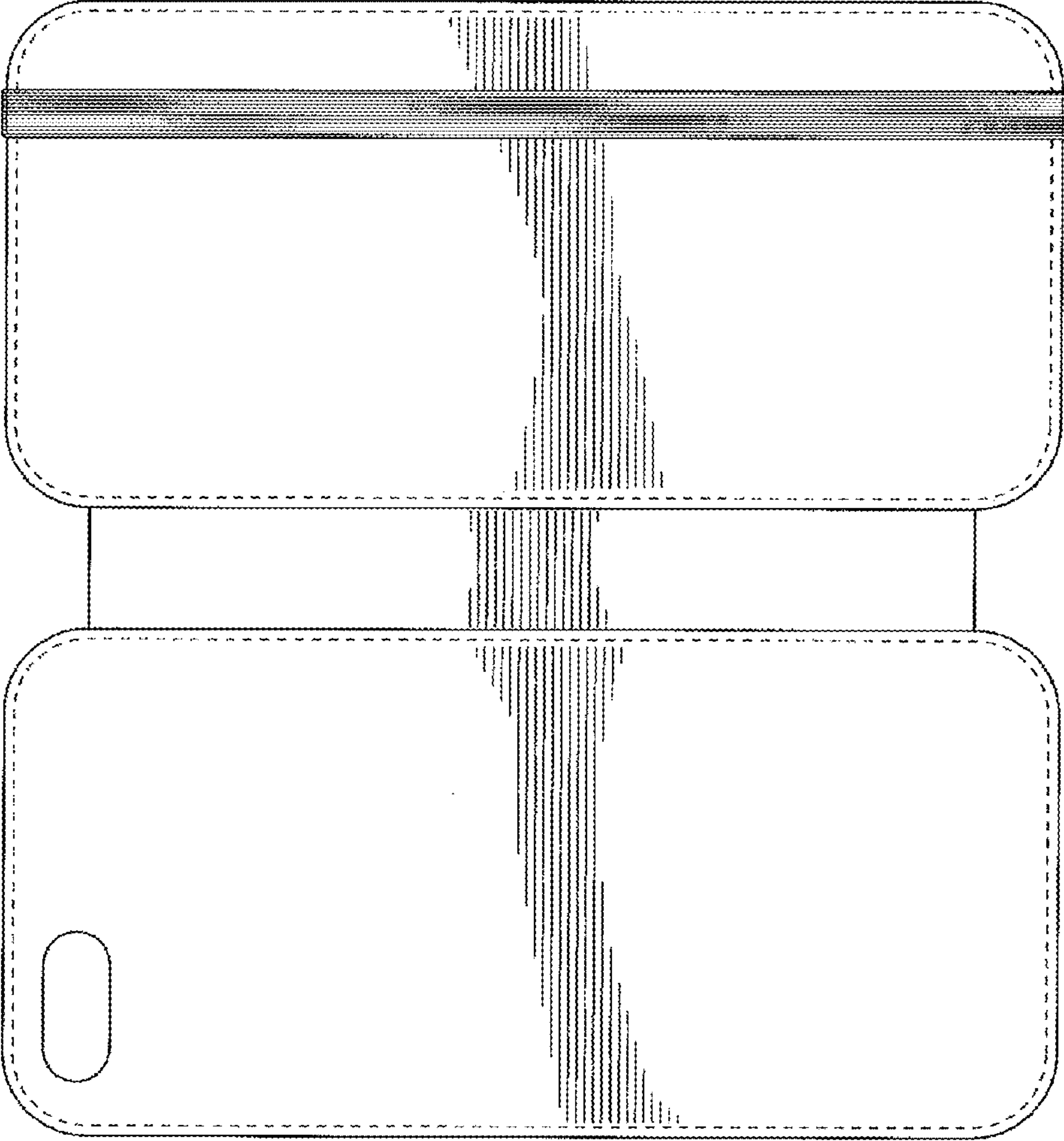

FIG. 10

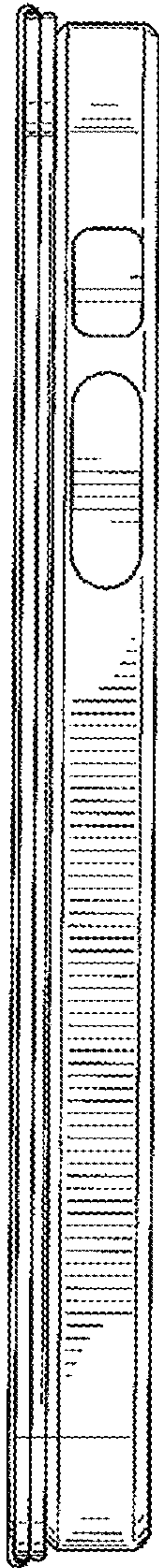

FIG. 11

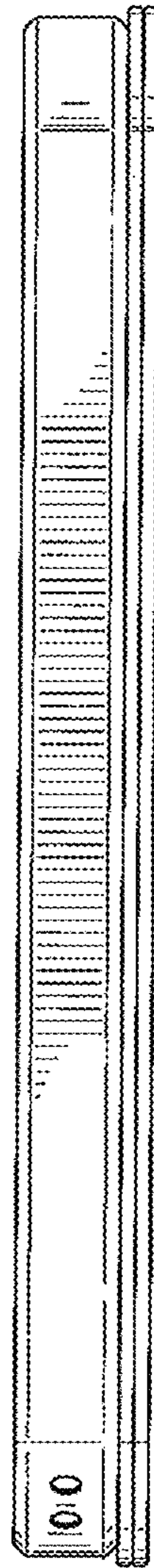

FIG. 12

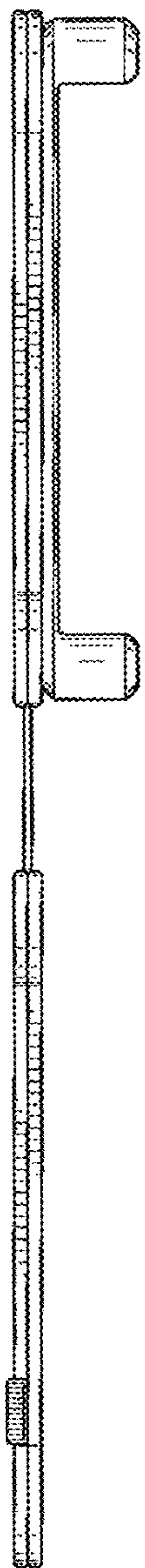

FIG. 13

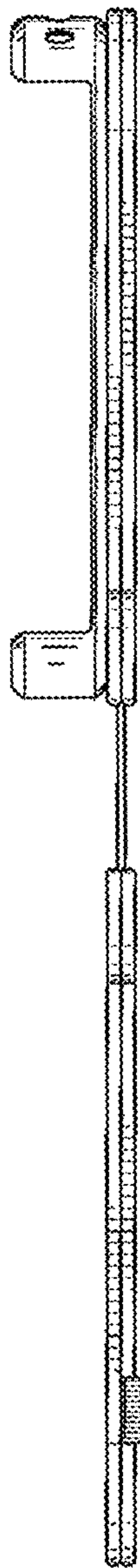

FIG. 14