



US00D760648S

(12) **United States Design Patent**
Lee et al.

(10) **Patent No.:** **US D760,648 S**
(45) **Date of Patent:** **** Jul. 5, 2016**

(54) **WIRELESS CHARGER FOR HEADSET**
(71) Applicant: **LG ELECTRONICS INC.**, Seoul (KR)
(72) Inventors: **Hophil Lee**, Seoul (KR); **Yooshin Ahn**,
Seoul (KR); **Seungbeom Park**, Seoul
(KR); **Hyunchul Kim**, Seoul (KR)
(73) Assignee: **LG Electronics Inc.**, Seoul (KR)

D607,458 S *	1/2010	Hui	D14/300
D615,491 S *	5/2010	Emminger	D13/108
D629,806 S *	12/2010	Ho	D14/434
D654,866 S *	2/2012	Rautiainen	D13/108
D663,731 S *	7/2012	Pajic	D14/408
D686,213 S *	7/2013	Haymond	D14/432
D693,814 S *	11/2013	Park	D14/434
D699,674 S *	2/2014	Man	D13/108
D726,651 S *	4/2015	Lin	D13/110
D734,746 S *	7/2015	Vogel	D14/253
D747,266 S *	1/2016	Nakaeda	D13/108

(**) Term: **14 Years**

* cited by examiner

(21) Appl. No.: **29/524,402**

Primary Examiner — Rosemary K Tarcza

(22) Filed: **Apr. 20, 2015**

Assistant Examiner — Nathaniel D Buckner

(30) **Foreign Application Priority Data**

(74) *Attorney, Agent, or Firm* — Birch, Stewart, Kolasch & Birch, LLP

Oct. 21, 2014 (KR) 30-2014-0050498

(51) **LOC (10) Cl.** **13-02**

(52) **U.S. Cl.**
USPC **D13/108**

(58) **Field of Classification Search**
USPC D13/107–110, 118–119, 184; D14/251,
D14/253, 432, 434
CPC Y02E 60/12; Y02T 90/14; Y02T 90/122;
Y02T 90/128; Y02T 90/163; H02J 7/025;
H02J 7/0042; H02J 7/0044; H02J 7/0045;
H02J 7/0003; H01F 38/14; H01R 13/6675;
H01M 2/1022; H01M 2/1055; H01M 10/44;
H01M 10/46; H01M 10/425; B60L 11/182
See application file for complete search history.

(57) **CLAIM**

The ornamental design for a wireless charger for headset, as shown and described.

(56) **References Cited**

U.S. PATENT DOCUMENTS

D482,653 S * 11/2003 Cho D13/110
D525,583 S * 7/2006 Vu D13/108

DESCRIPTION

FIG. 1 is a perspective view of a wireless charger for headset showing our new design;
FIG. 2 is a front view thereof;
FIG. 3 is a rear view thereof;
FIG. 4 is a left side view thereof where the right side view is a mirror image;
FIG. 5 is a top plan view thereof;
FIG. 6 is a bottom plan view thereof; and,
FIG. 7 is a reference view thereof showing the way of the headset being attached to the subject design.
The broken lines in FIG. 7 show environmental structure only and form no part of the claimed design.

1 Claim, 6 Drawing Sheets

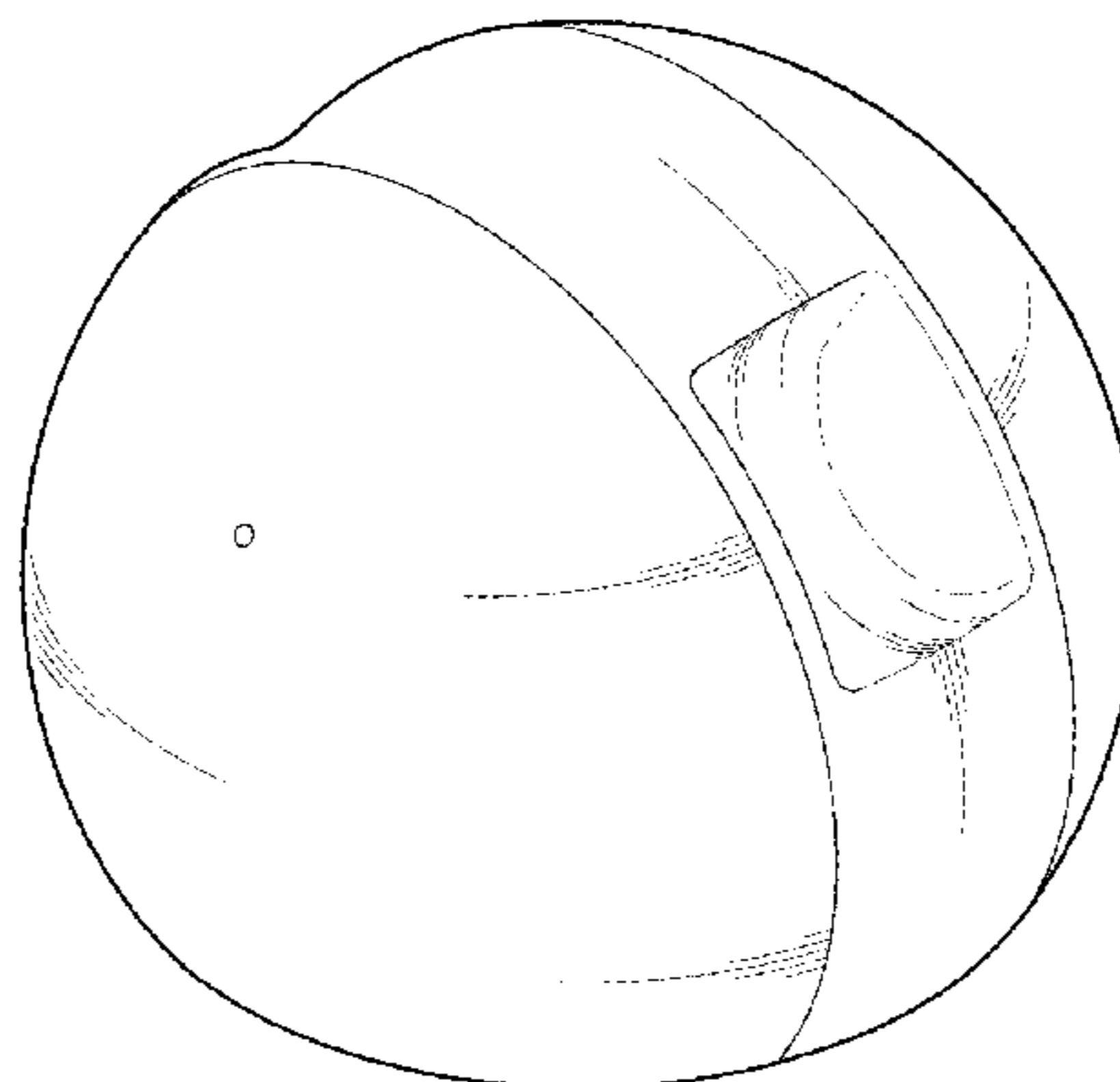

FIG. 1

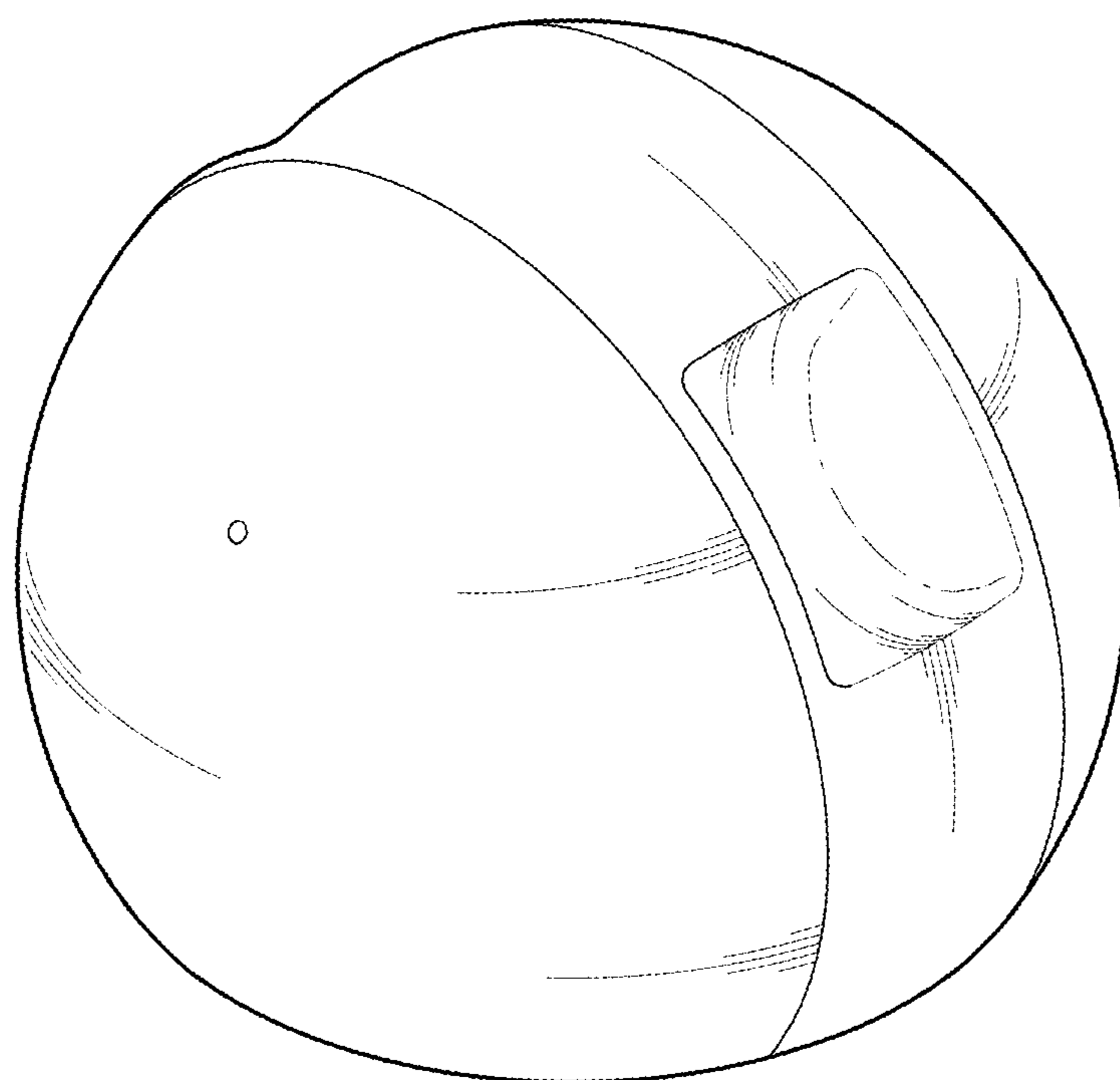

FIG. 2

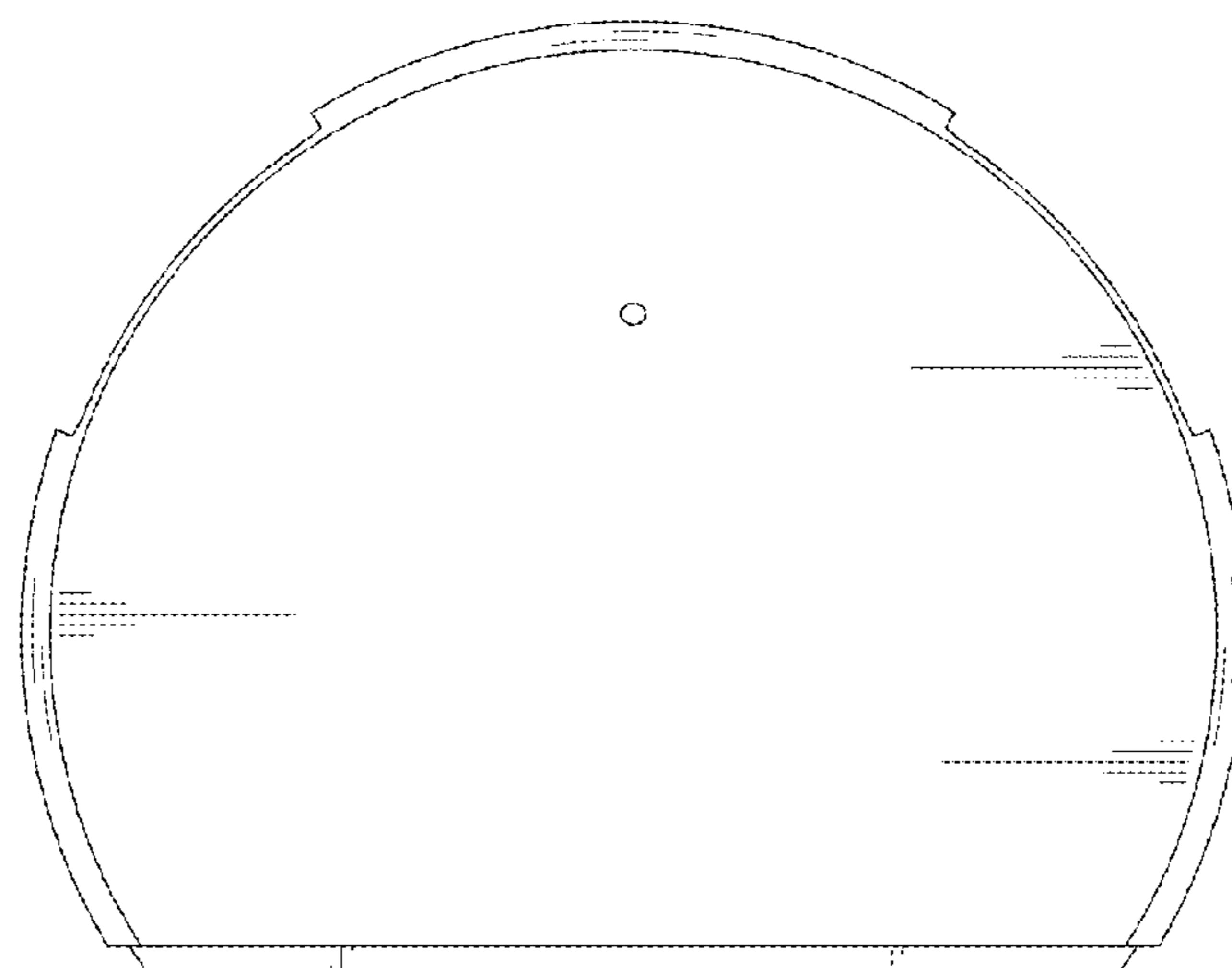

FIG. 3

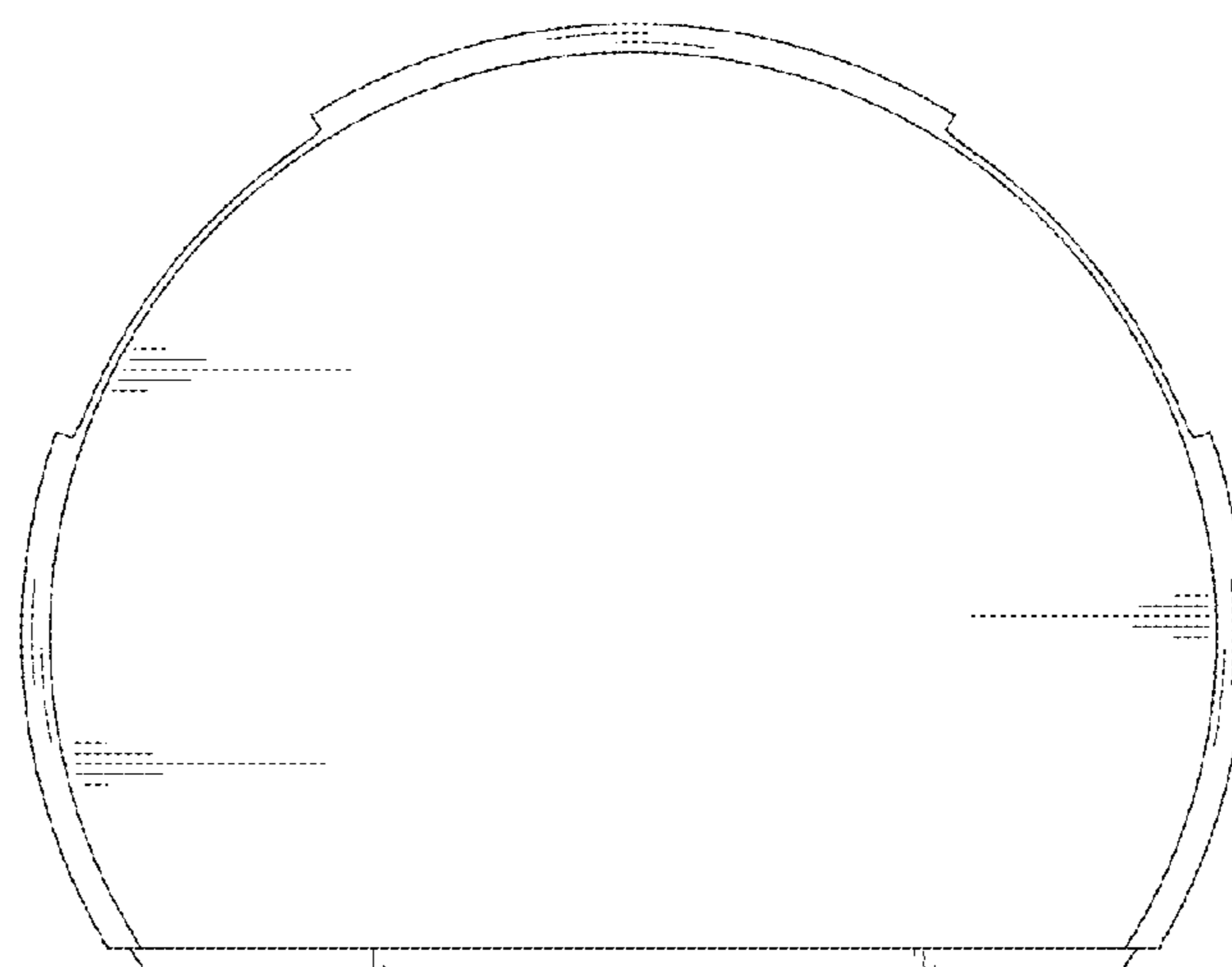

FIG. 4

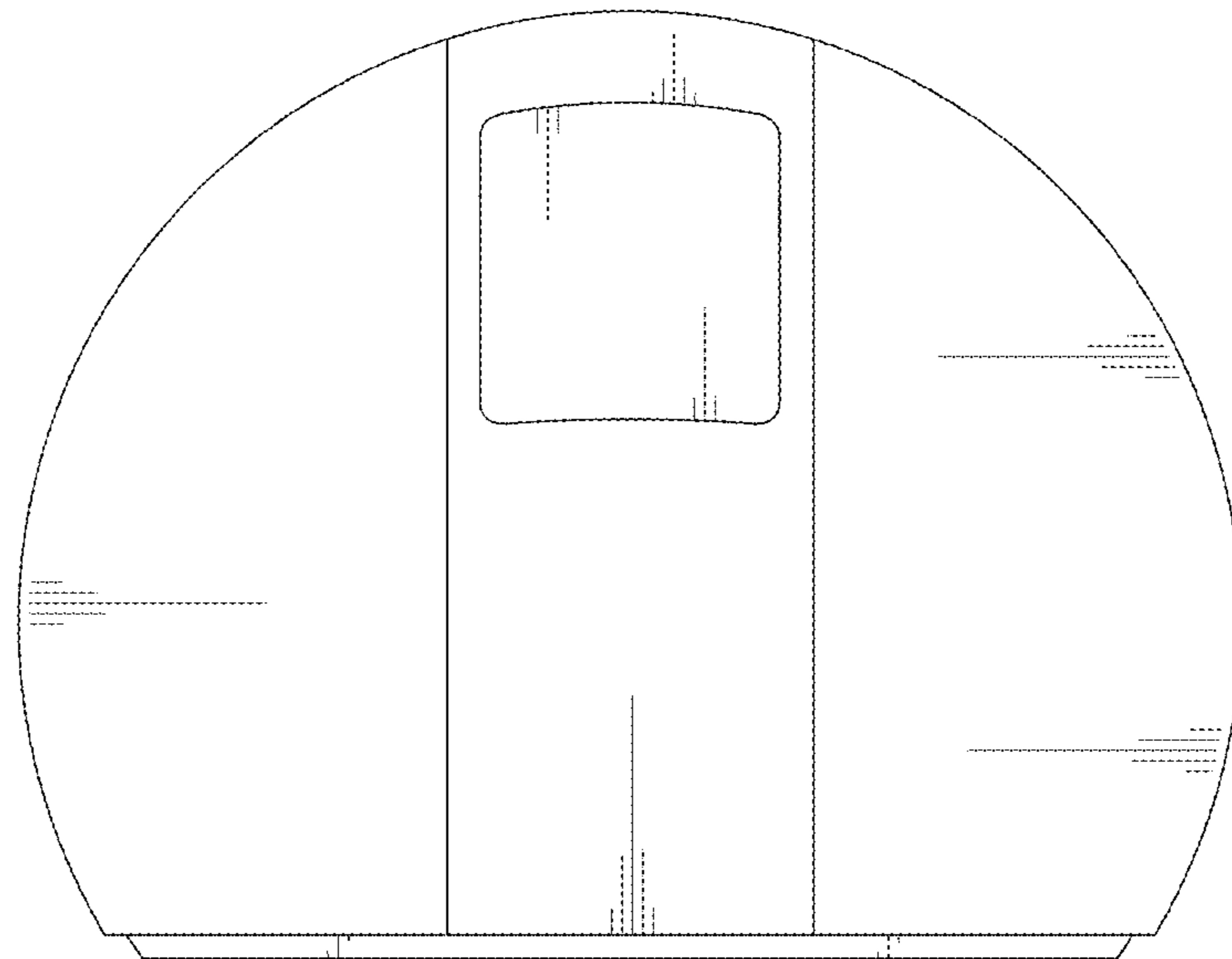

FIG. 5

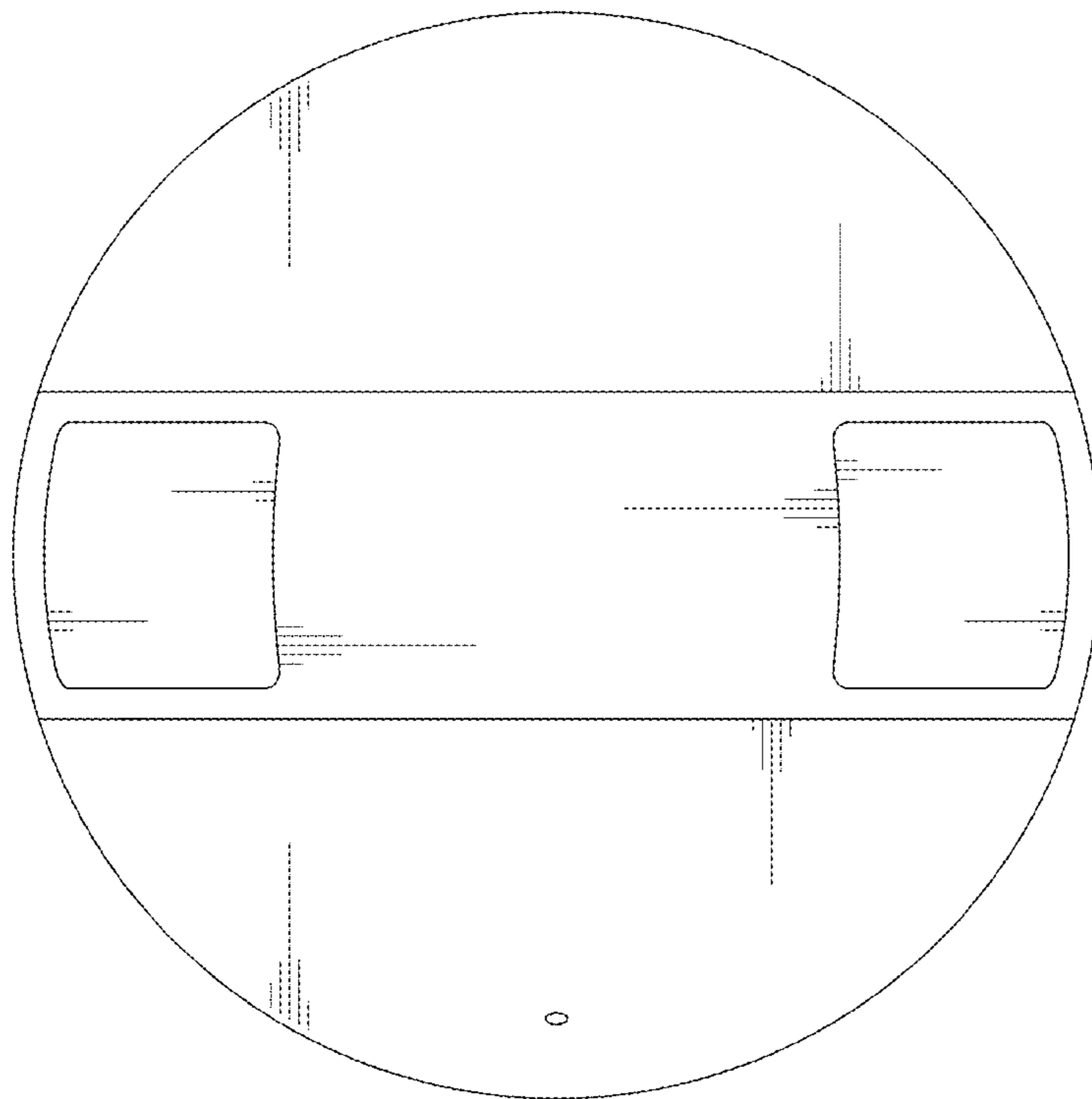

FIG. 6

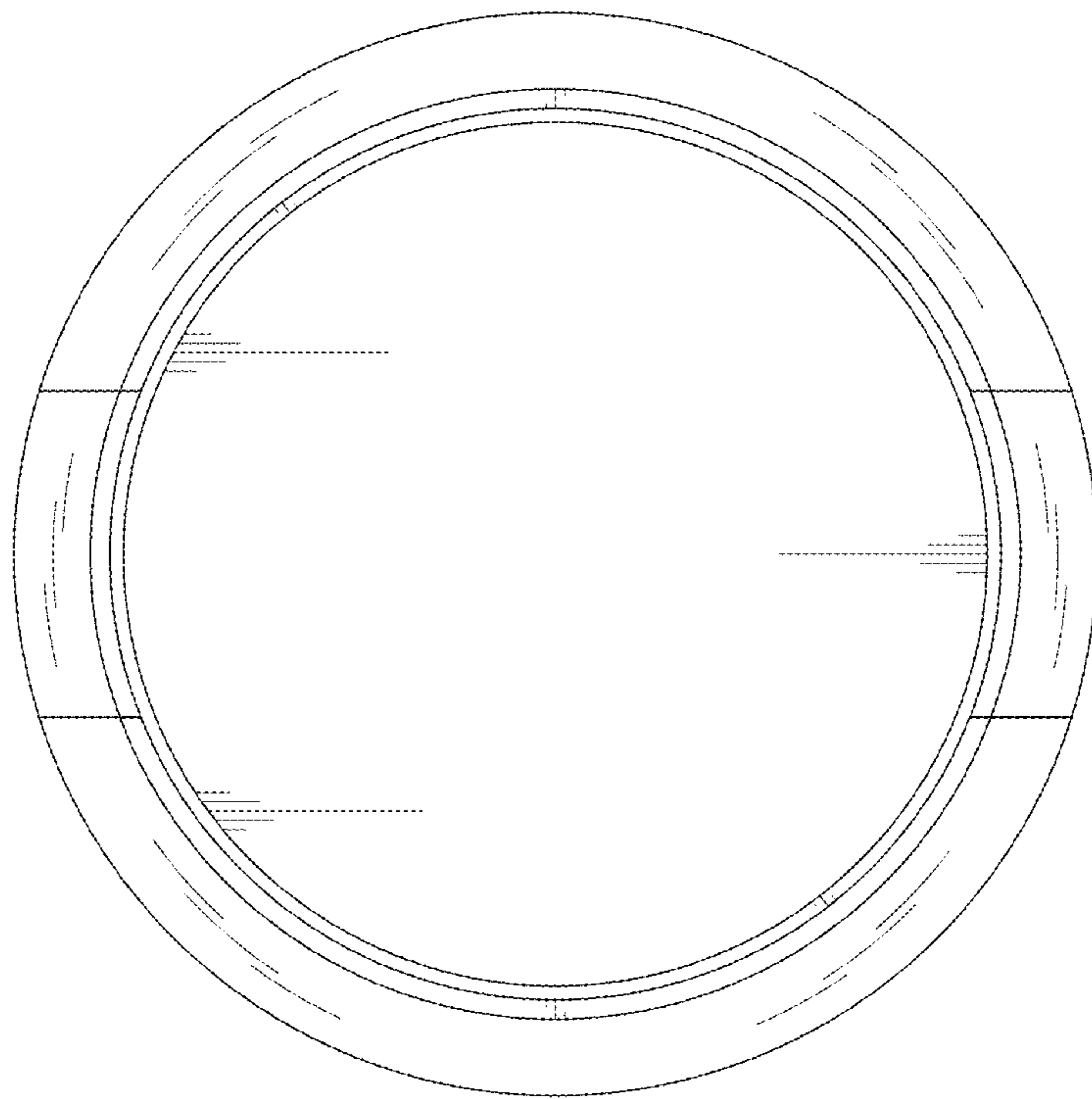

FIG. 7

