



US00D760619S

(12) **United States Design Patent**  
**Gabriel**

(10) **Patent No.:** **US D760,619 S**  
(45) **Date of Patent:** **\*\* Jul. 5, 2016**

(54) **ARTICLE OF JEWELRY**

(71) Applicant: **Valerie Vance Gabriel**, Henderson, NV  
(US)

(72) Inventor: **Valerie Vance Gabriel**, Henderson, NV  
(US)

(\*\*) Term: **14 Years**

(21) Appl. No.: **29/488,135**

(22) Filed: **Apr. 16, 2014**

(51) **LOC (10) Cl.** ..... **11-01**

(52) **U.S. Cl.**  
USPC ..... **D11/61**; D11/81

(58) **Field of Classification Search**  
USPC ..... D11/1-47, 61, 69, 79-86; D3/211  
CPC ..... A44C 9/00; A44C 9/0046; A44C 9/0084;  
A44C 11/00; A44C 11/002; A44C 5/00;  
A44C 5/12; A44C 5/0084; A44C 5/0092;  
A44C 7/00; A44C 7/004; A44C 7/005;  
A44C 7/006; A44C 7/007; A44C 7/008;  
A44C 7/009; A44C 17/02; A44C 15/004  
See application file for complete search history.

(56) **References Cited**

**U.S. PATENT DOCUMENTS**

- D10,354 S \* 12/1877 Miller et al. .... D11/61
- D14,485 S \* 12/1883 Wood ..... D11/61
- D39,164 S \* 3/1908 Barry ..... D11/61
- D40,516 S \* 2/1910 Gaynor ..... D11/116
- D43,407 S \* 12/1912 Miller ..... D11/61
- D56,694 S \* 11/1920 Davidson ..... D11/116
- D98,707 S \* 2/1936 Anderson ..... D11/10
- D102,441 S \* 12/1936 Murray ..... D11/81
- 2,247,944 A \* 7/1941 Galligan ..... A44B 9/02  
40/622
- D169,082 S \* 3/1953 Neal ..... D11/116
- 3,688,426 A \* 9/1972 Andreoli ..... A44C 15/004  
40/618
- D281,959 S \* 12/1985 Balbuena ..... D11/116
- 4,581,271 A \* 4/1986 Gordon ..... A44C 5/0015  
2/311
- 5,097,679 A \* 3/1992 Johnson ..... A44C 13/00  
63/23

- D327,030 S \* 6/1992 Young ..... D11/61
- D378,503 S \* 3/1997 Limtanakool ..... D11/79
- D528,939 S \* 9/2006 Casassa ..... D11/95
- D556,080 S \* 11/2007 Day ..... D11/86
- D668,176 S \* 10/2012 Kreuzer ..... D11/125
- D727,092 S \* 4/2015 Rudisill ..... D7/392.1

**OTHER PUBLICATIONS**

- [Online] [https://www.etsy.com/listing/170534571/sigma-sorority-cz-greek-letter-silver?ga\\_order=most\\_relevant&ga\\_search\\_type=all&ga\\_view\\_type=gallery&ga\\_search\\_query=cz%20greek%20letter%20charm&ref=sr\\_gallery\\_12](https://www.etsy.com/listing/170534571/sigma-sorority-cz-greek-letter-silver?ga_order=most_relevant&ga_search_type=all&ga_view_type=gallery&ga_search_query=cz%20greek%20letter%20charm&ref=sr_gallery_12). Retrieved Oct. 29, 2015.\*
- [Online] <https://s-media-cache-ak0.pinimg.com/736x/12/e9/99/12e999e560d50fd312f962f5986e63a5.jpg>. Retrieved Oct. 29, 2015.\*
- [Online] [https://img1.etsystatic.com/100/0/5778844/il\\_340x270.831913863\\_kq47.jpg](https://img1.etsystatic.com/100/0/5778844/il_340x270.831913863_kq47.jpg). Retrieved Oct. 29, 2015.\*

\* cited by examiner

*Primary Examiner* — Garth Rademaker  
*Assistant Examiner* — Melanie Pellegrini  
(74) *Attorney, Agent, or Firm* — FisherBroyles, LLP; Jason M. Pass

(57) **CLAIM**

I claim the ornamental design for an article of jewelry, as shown and described.

**DESCRIPTION**

A portion of the disclosure of this patent document contains material to which a claim for copyright is made. The copyright owner has no objection to the reproduction of the patent document or the patent disclosure, as it appears in the U.S. Patent Office records, but reserves all other copyright rights whatsoever.

FIG. 1 is a front view of a first embodiment of an article of jewelry according to my design;

FIG. 2 is a left perspective view of the article of jewelry of FIG. 1;

FIG. 3 is a front view of a second embodiment of an article of jewelry according to my design;

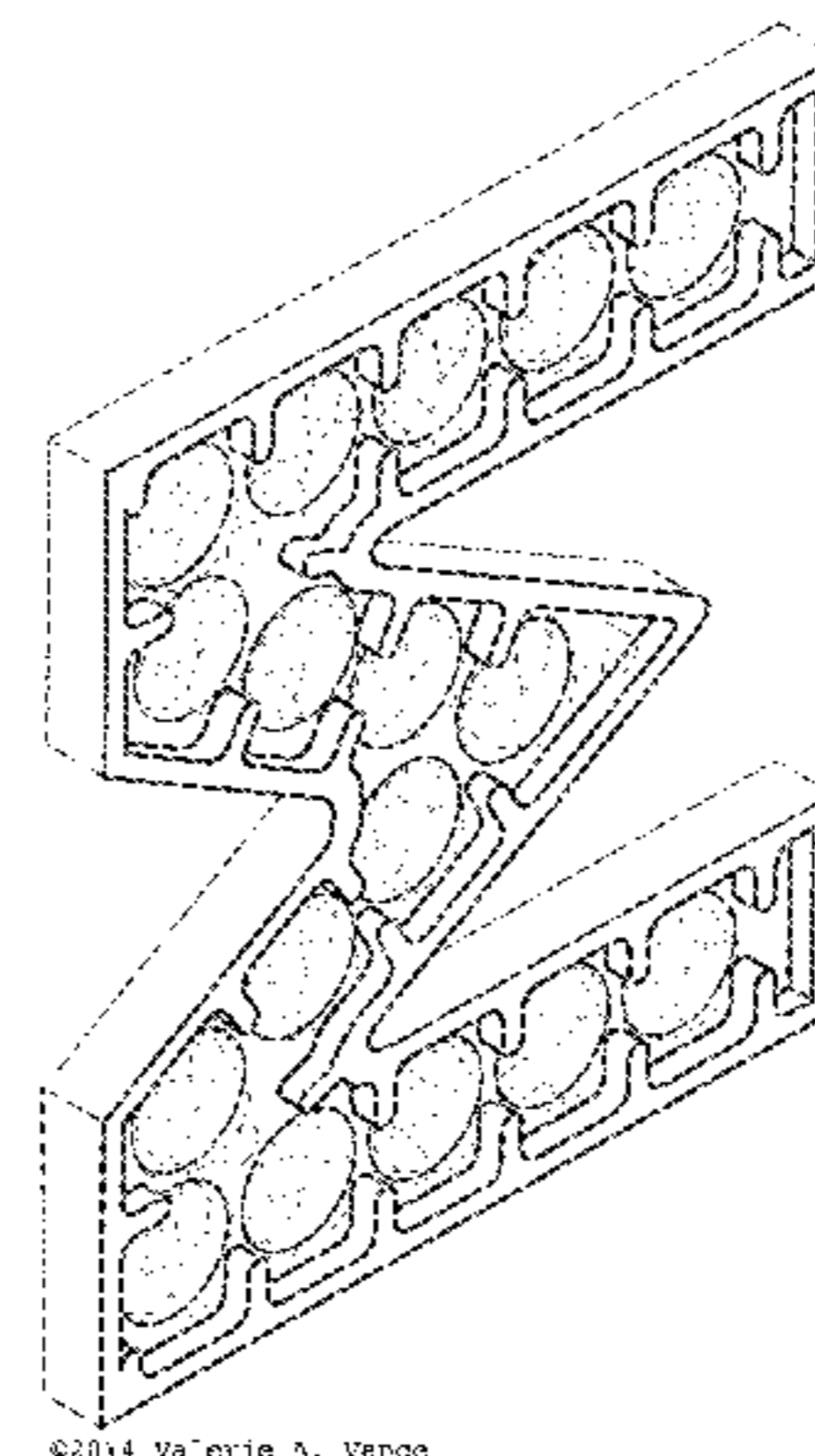
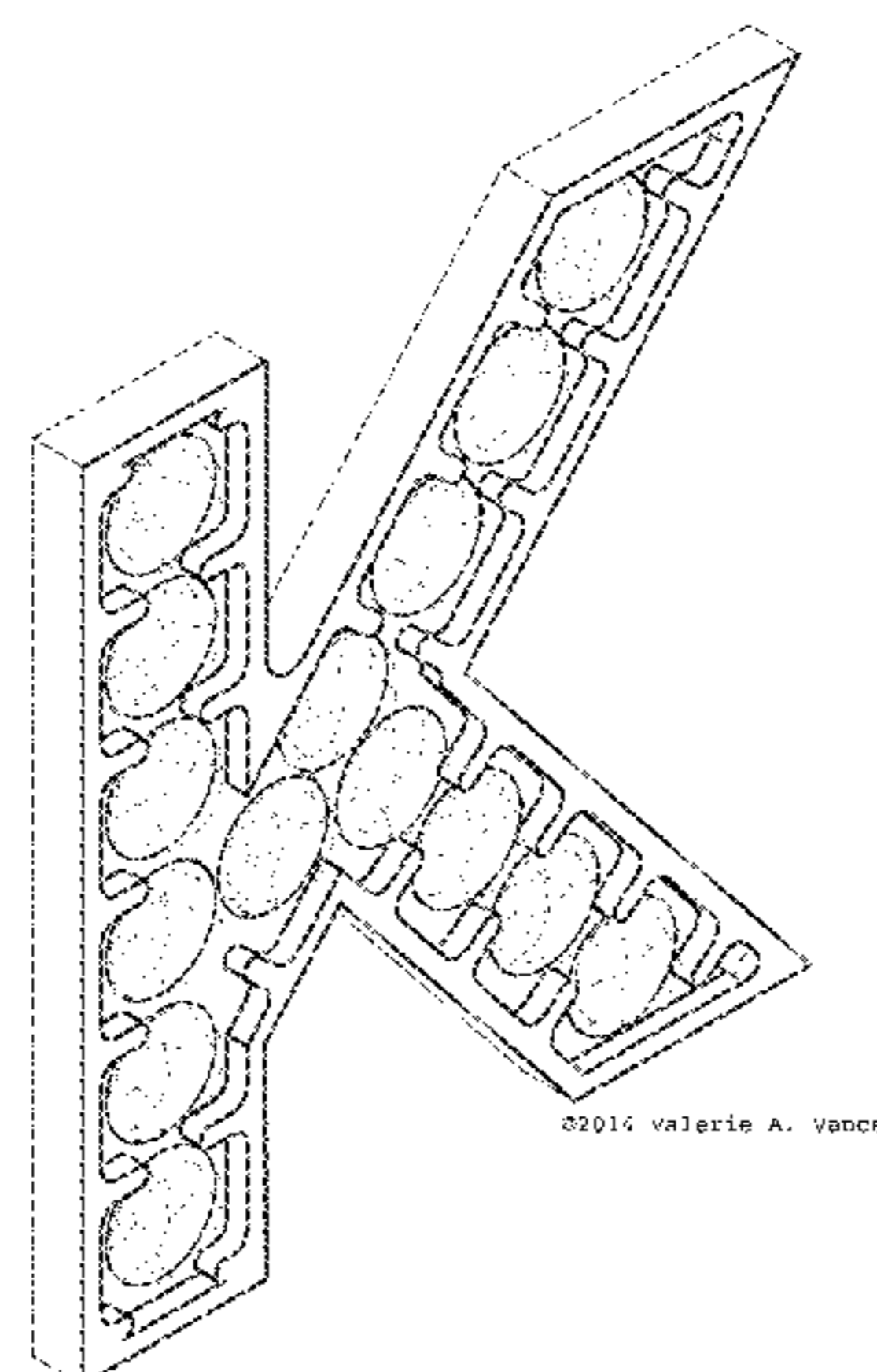

©2014 Valerie A. Vance

©2014 Valerie A. Vance

FIG. 4 is a left perspective view of the article of jewelry of FIG. 3;

FIG. 5 is a front view of a third embodiment of an article of jewelry according to my design;

FIG. 6 is a left perspective view of the article of jewelry of FIG. 5;

FIG. 7 is a front view of a fourth embodiment of an article of jewelry according to my design;

FIG. 8 is a left perspective view of the article of jewelry of FIG. 7;

FIG. 9 is a front view of a fifth embodiment of an article of jewelry according to my design;

FIG. 10 is a left perspective view of the article of jewelry of FIG. 9;

FIG. 11 is a front view of a sixth embodiment of an article of jewelry according to my design;

FIG. 12 is a left perspective view of the article of jewelry of FIG. 11;

FIG. 13 is a front view of a seventh embodiment of an article of jewelry according to my design;

FIG. 14 is a left perspective view of the article of jewelry of FIG. 13;

FIG. 15 is a front view of an eighth embodiment of an article of jewelry according to my design; and,

FIG. 16 is a left perspective view of the article of jewelry of FIG. 15.

FIG. 17 is a front view of a ninth embodiment of an article of jewelry according to my design; and,

FIG. 18 is a left perspective view of the article of jewelry of FIG. 17.

The broken lines shown in the drawings illustrate portions of the article of jewelry that form no part of the claimed design.

**1 Claim, 18 Drawing Sheets**

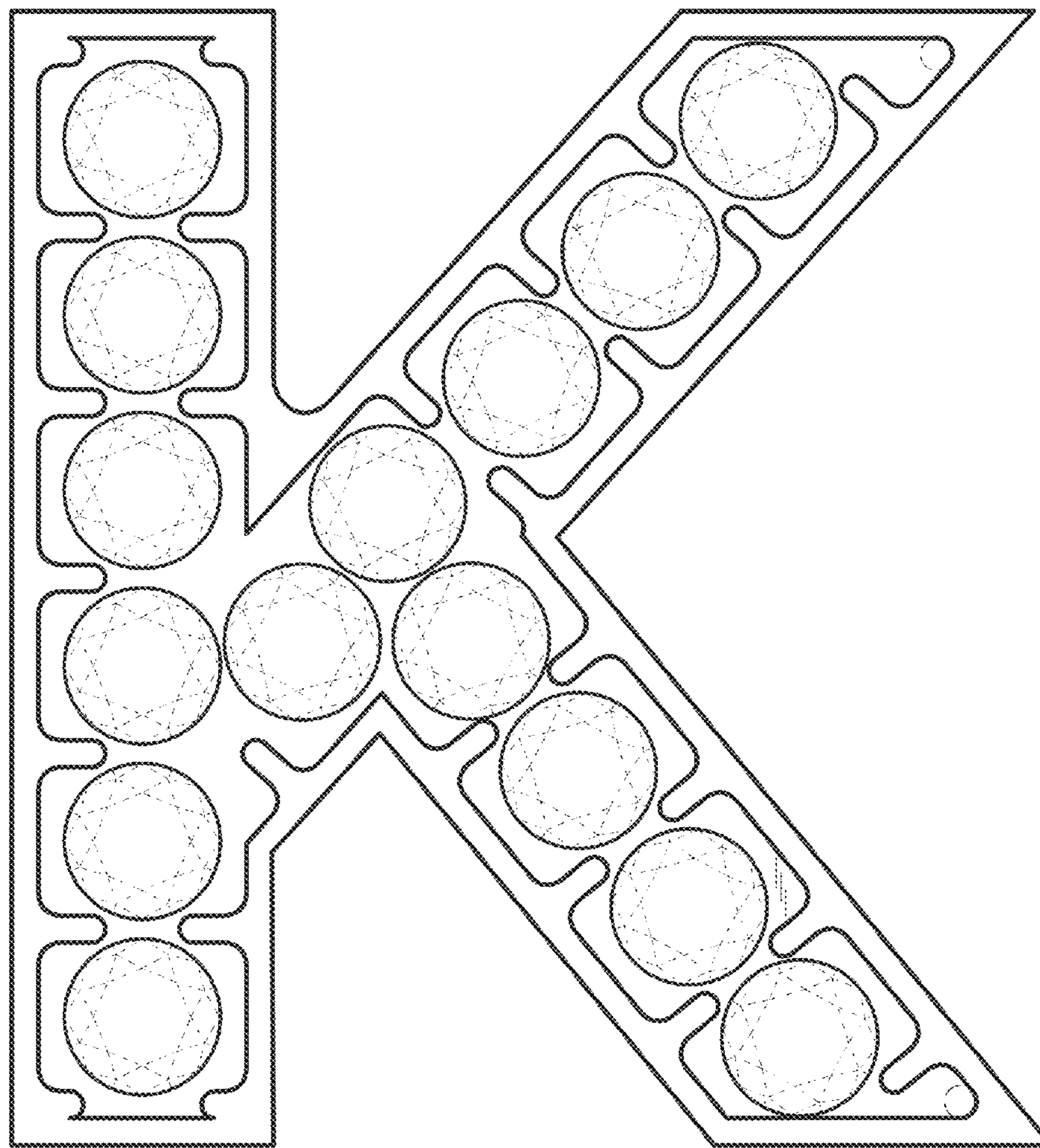

©2014 Valerie A. Vance

Fig. 1

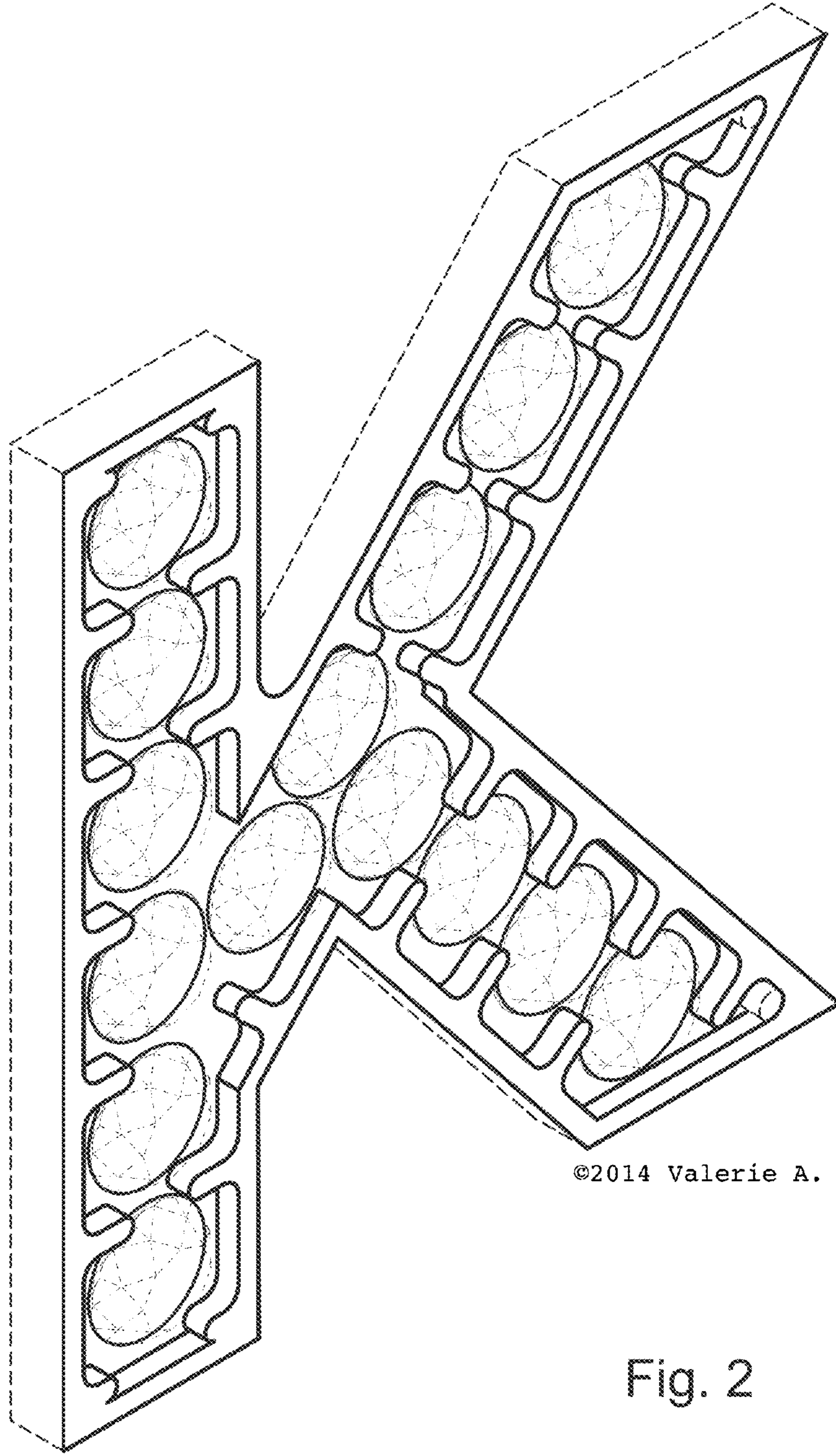

©2014 Valerie A. Vance

Fig. 2

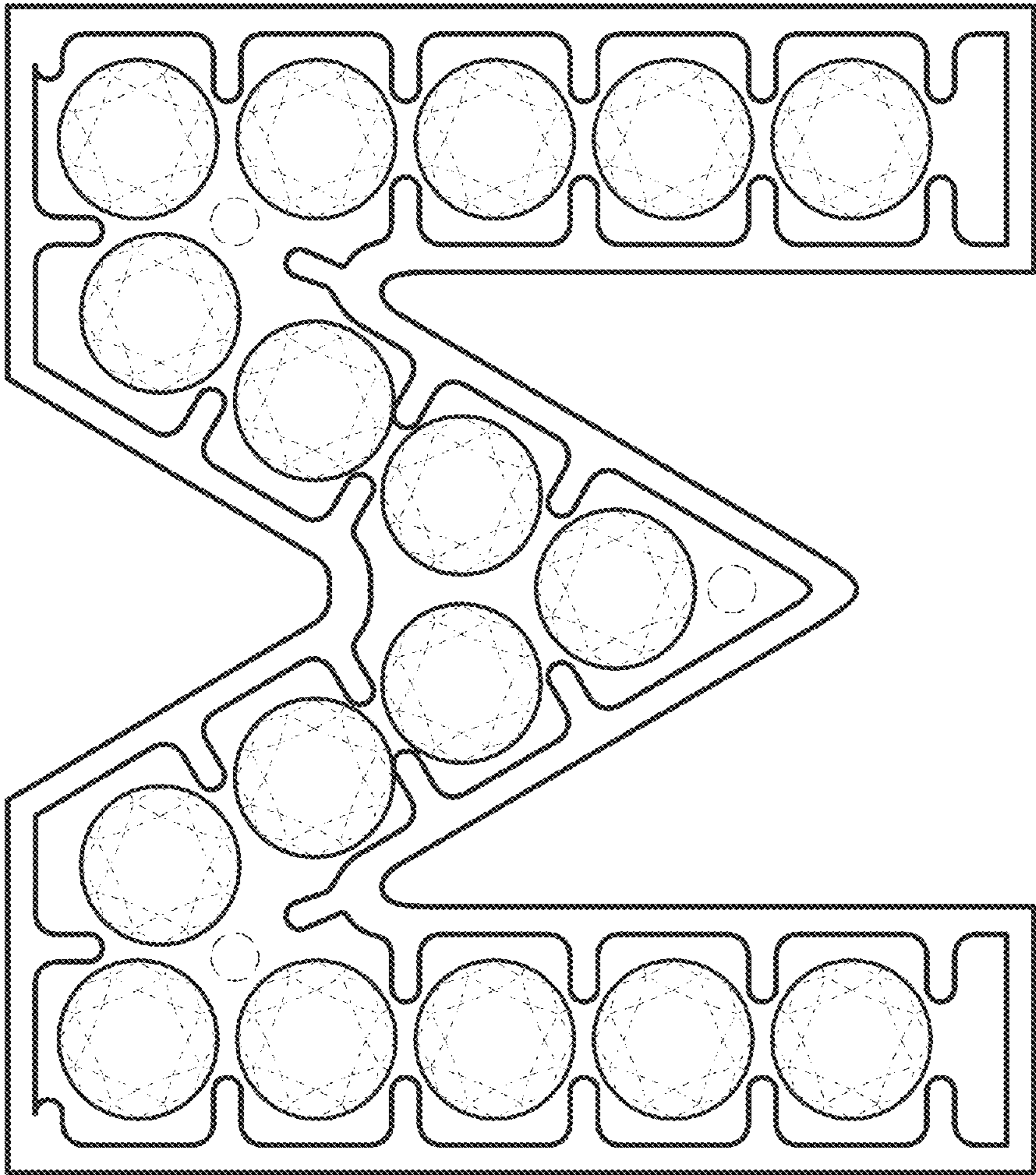

©2014 Valerie A. Vance

Fig. 3

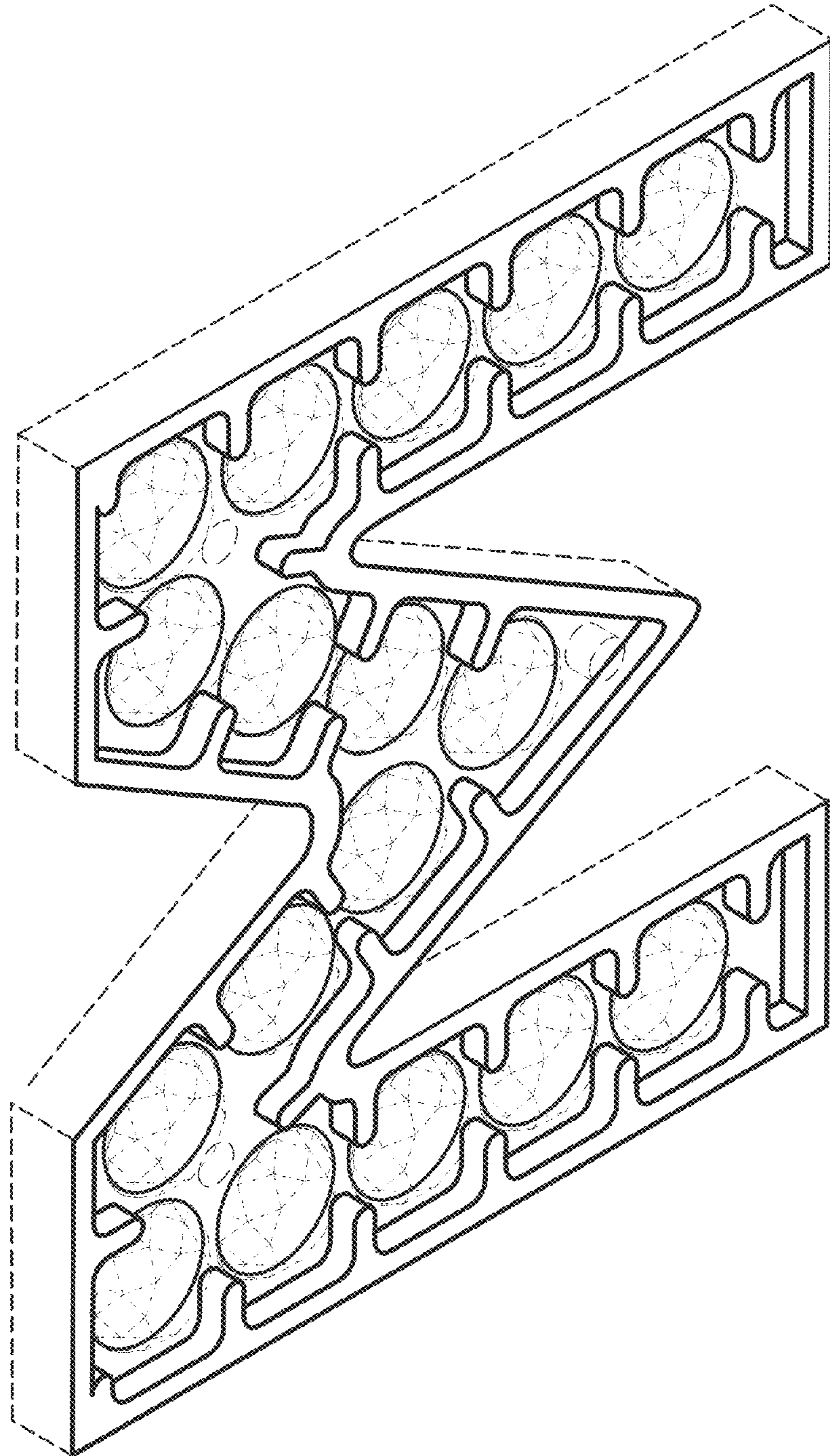

©2014 Valerie A. Vance

Fig. 4

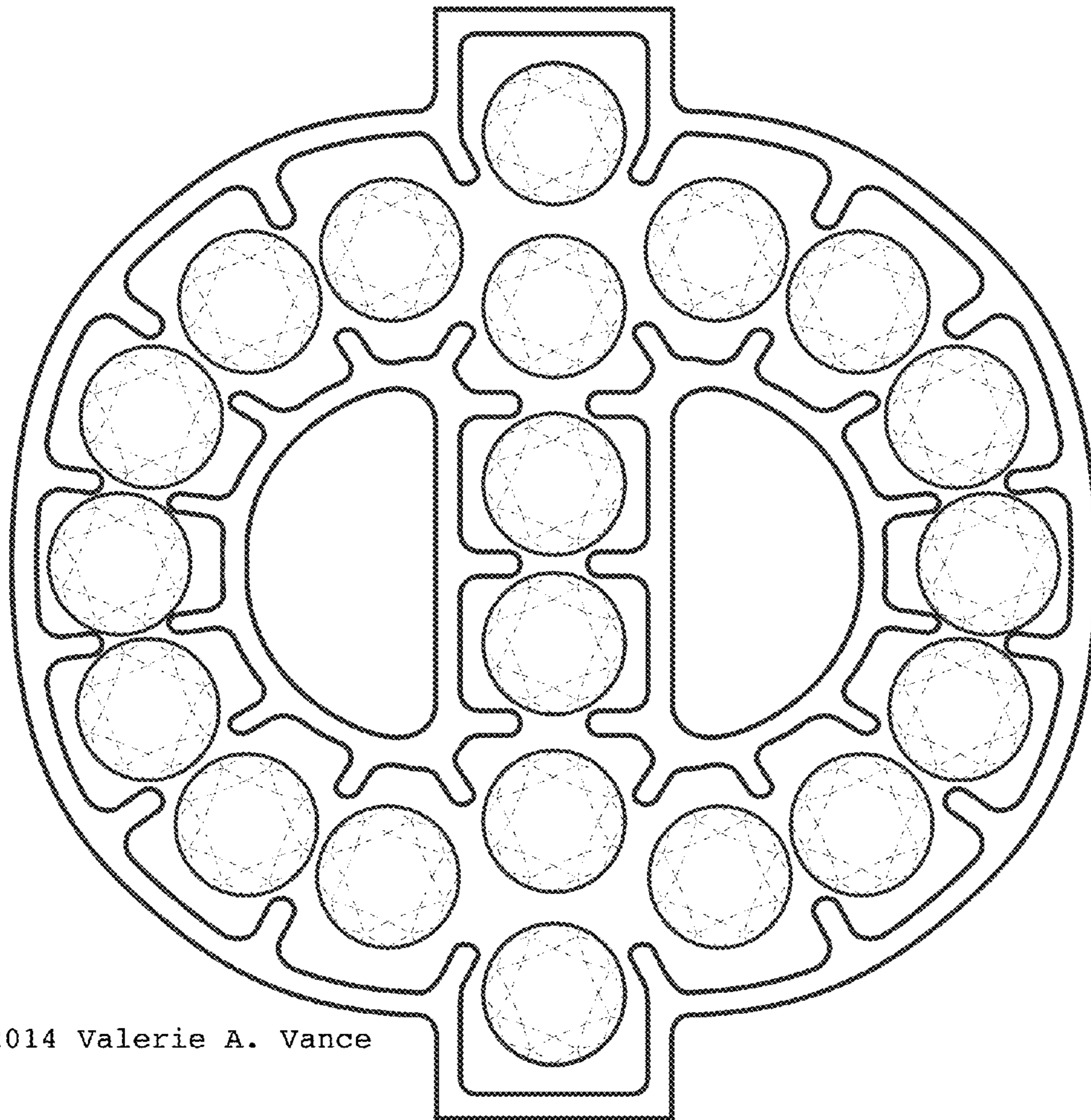

©2014 Valerie A. Vance

Fig. 5

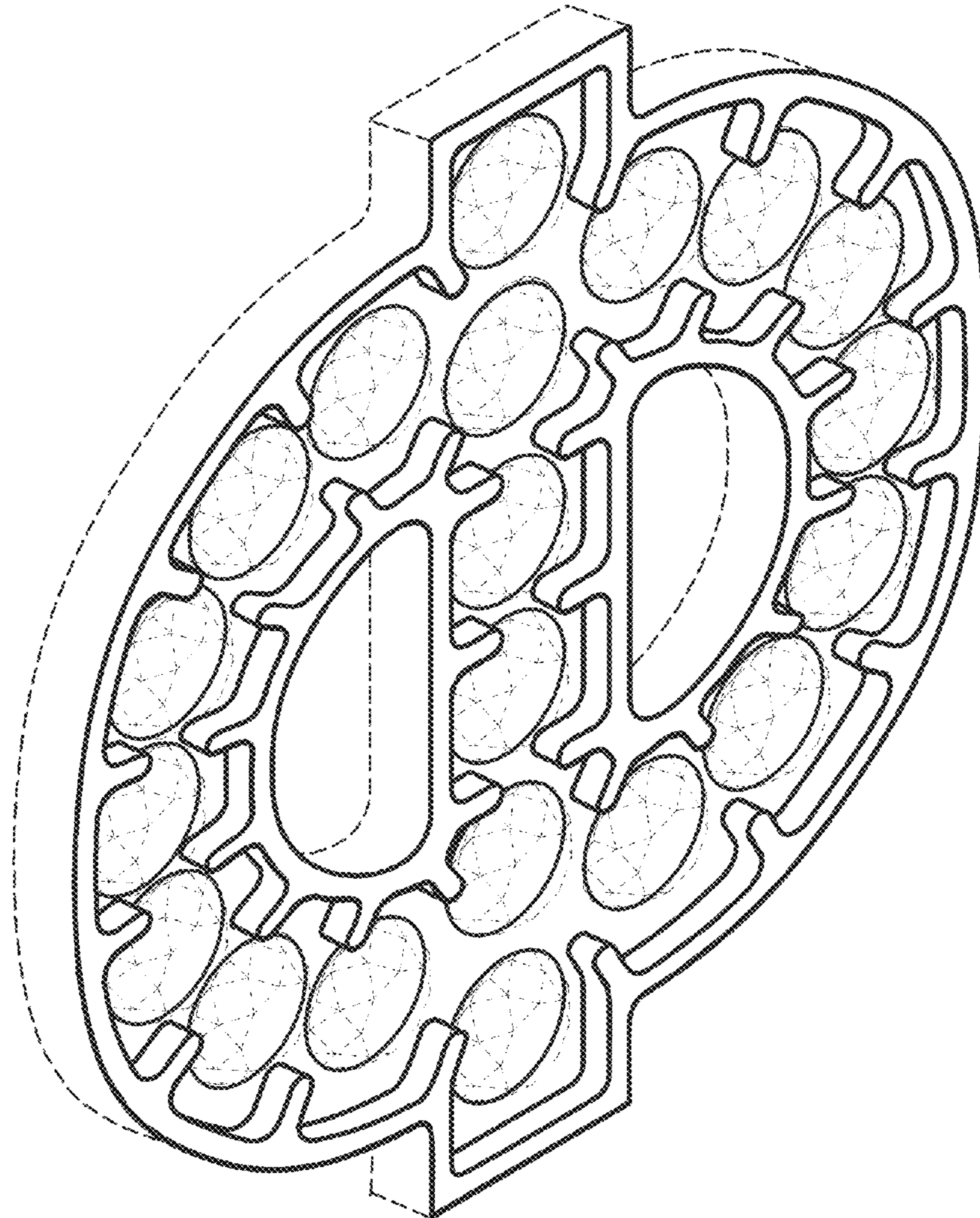

©2014 Valerie A. Vance

Fig. 6



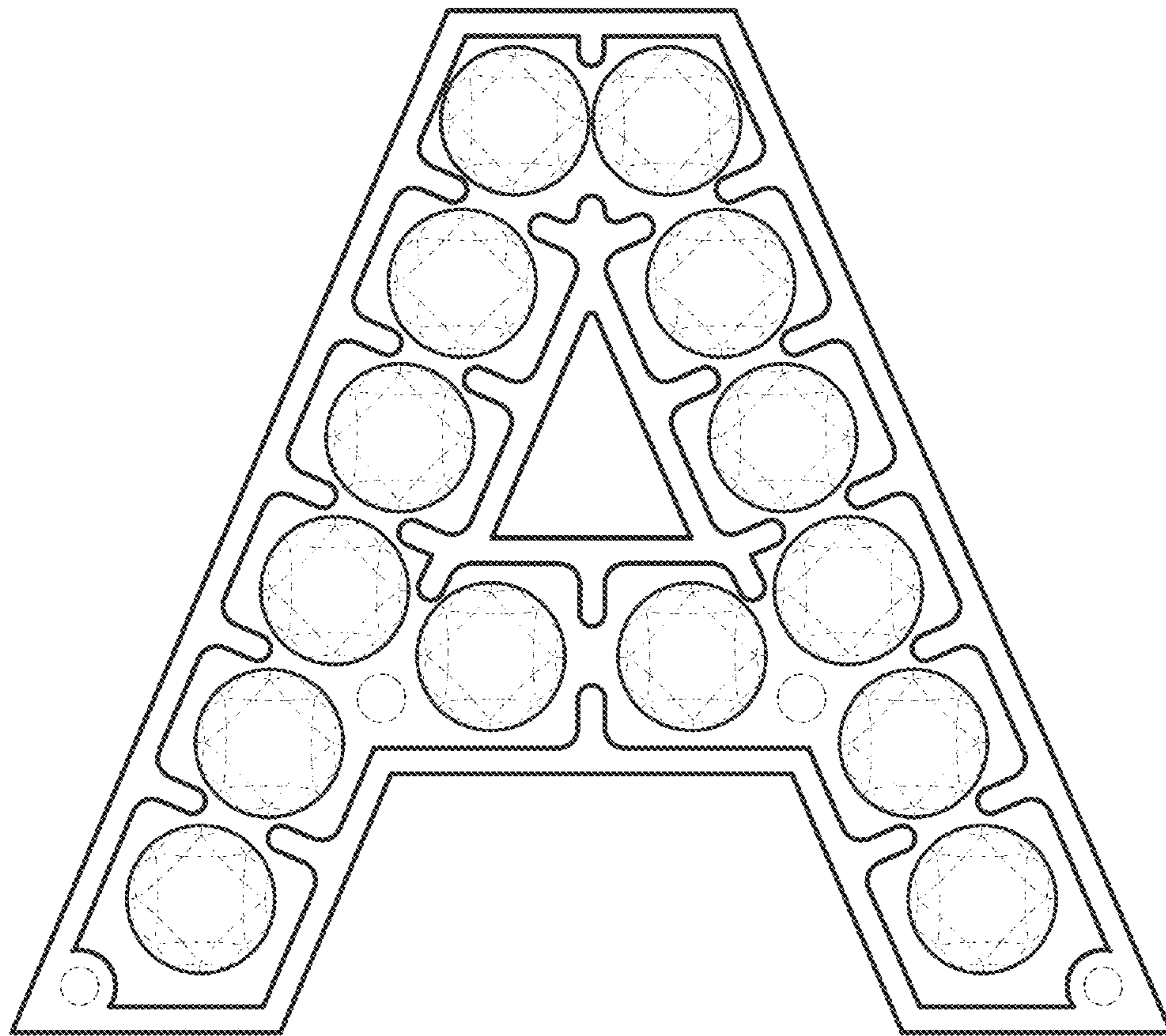

©2014 Valerie A. Vance

Fig. 7

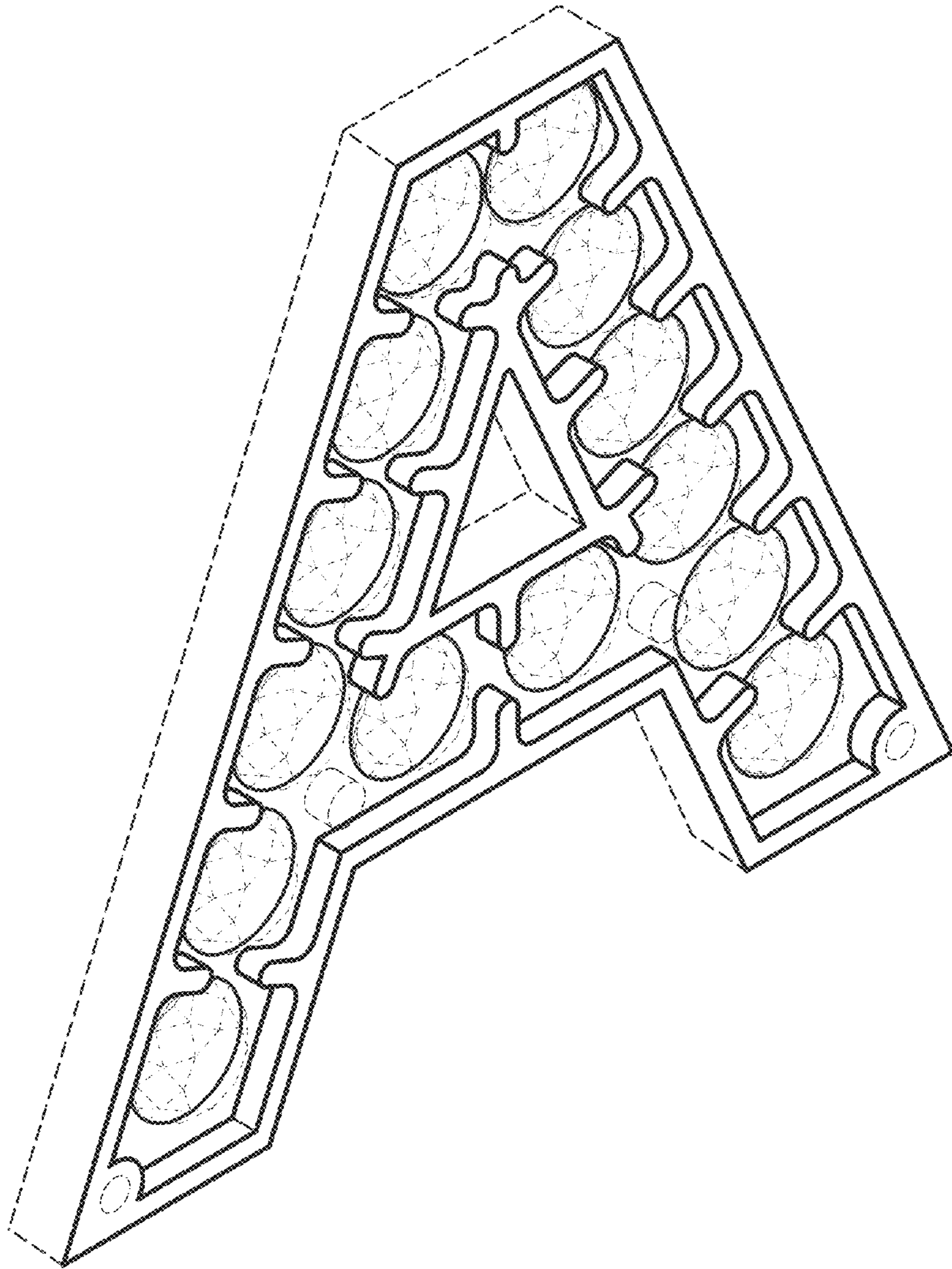

©2014 Valerie A. Vance

Fig. 8

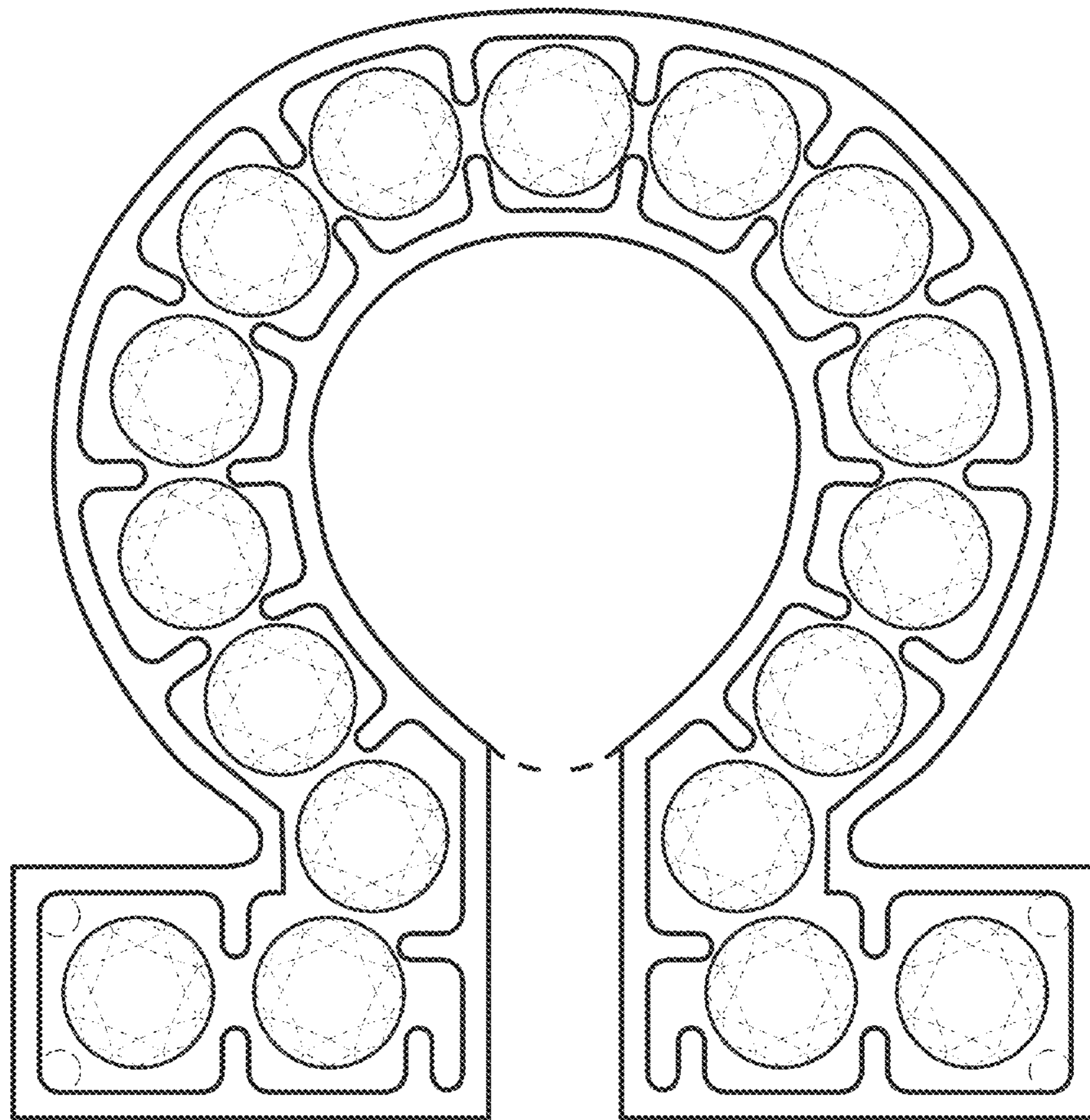

©2014 Valerie A. Vance

Fig. 9

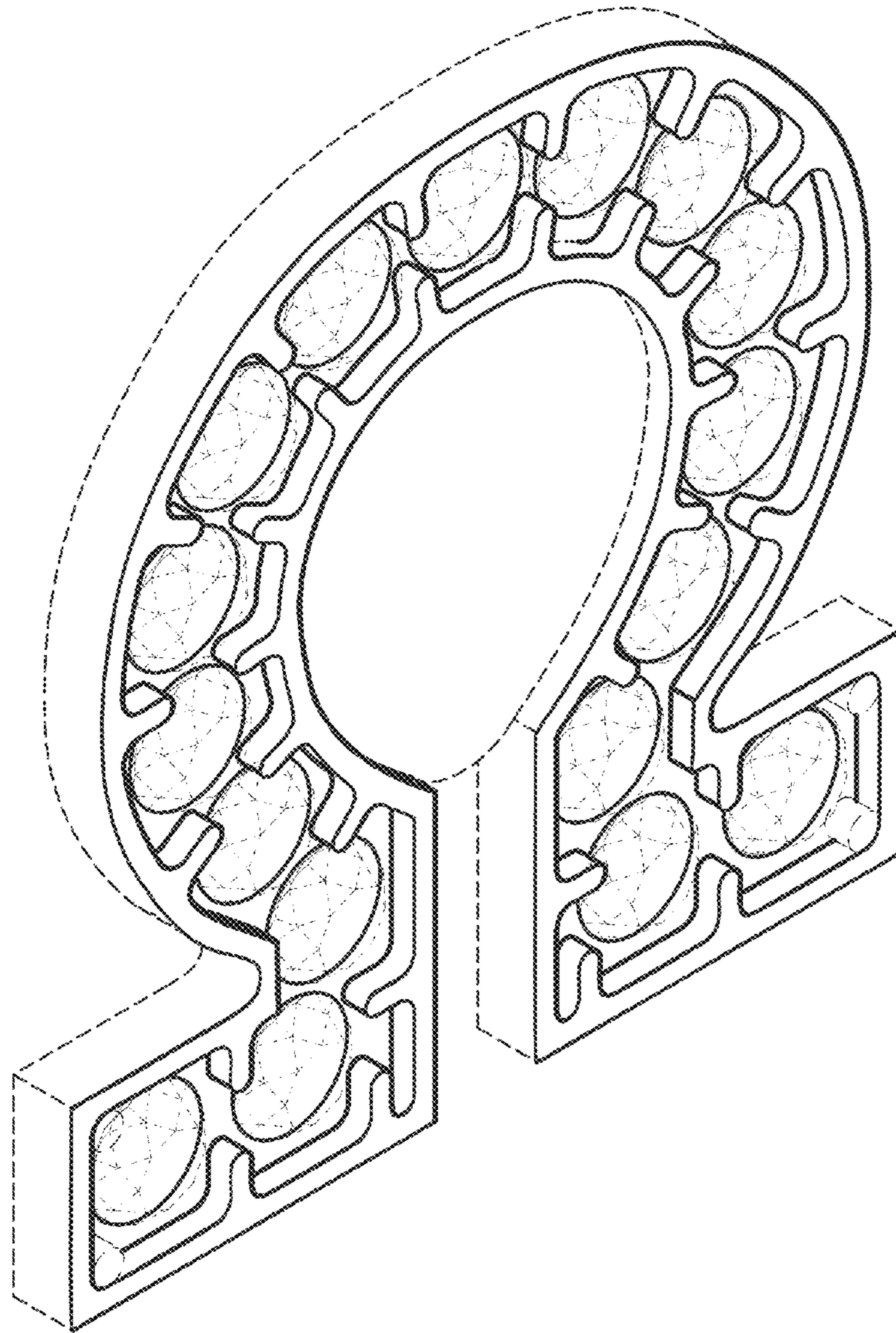

©2014 Valerie A. Vance

Fig. 10

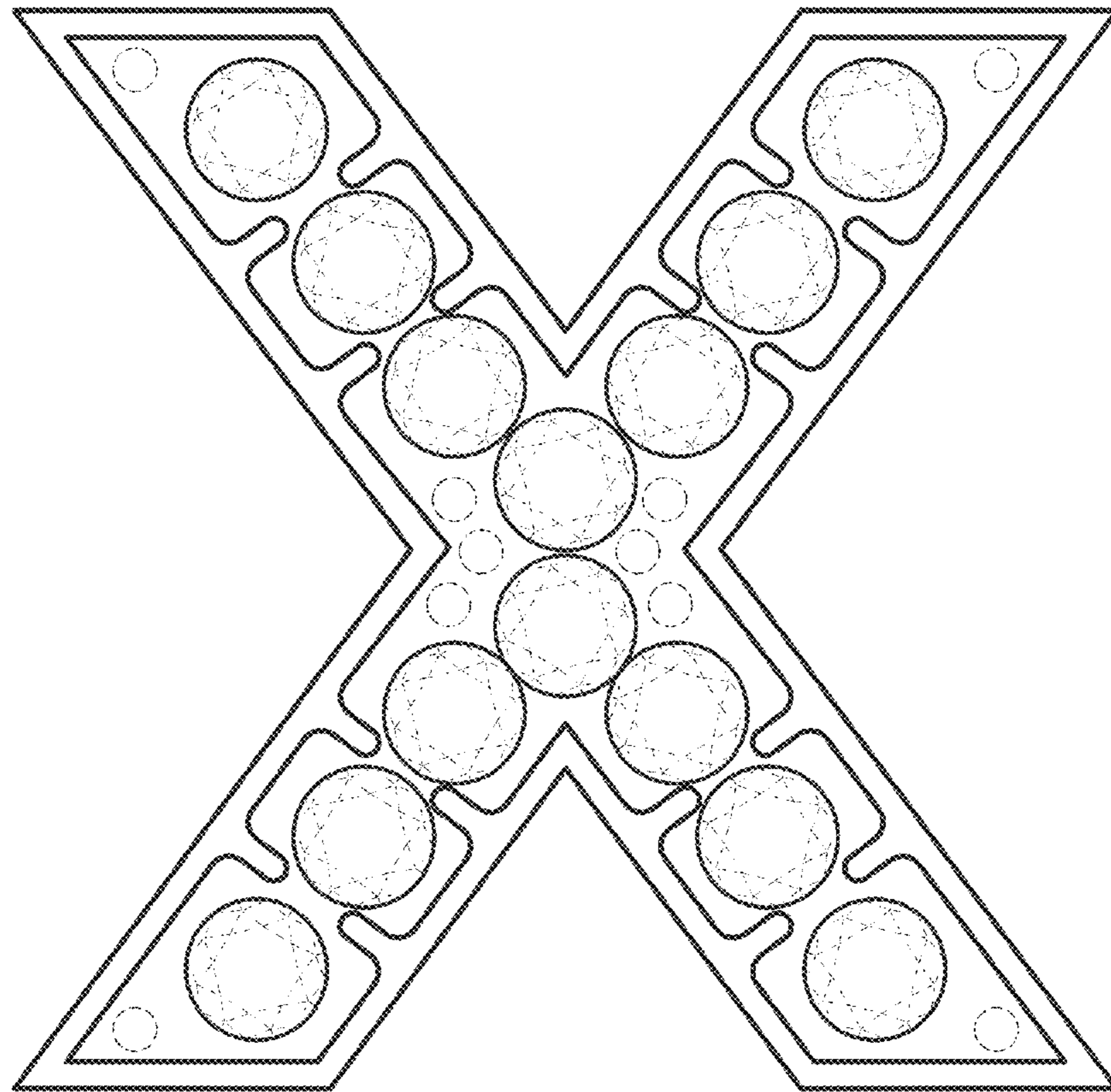

©2014 Valerie A. Vance

Fig. 11

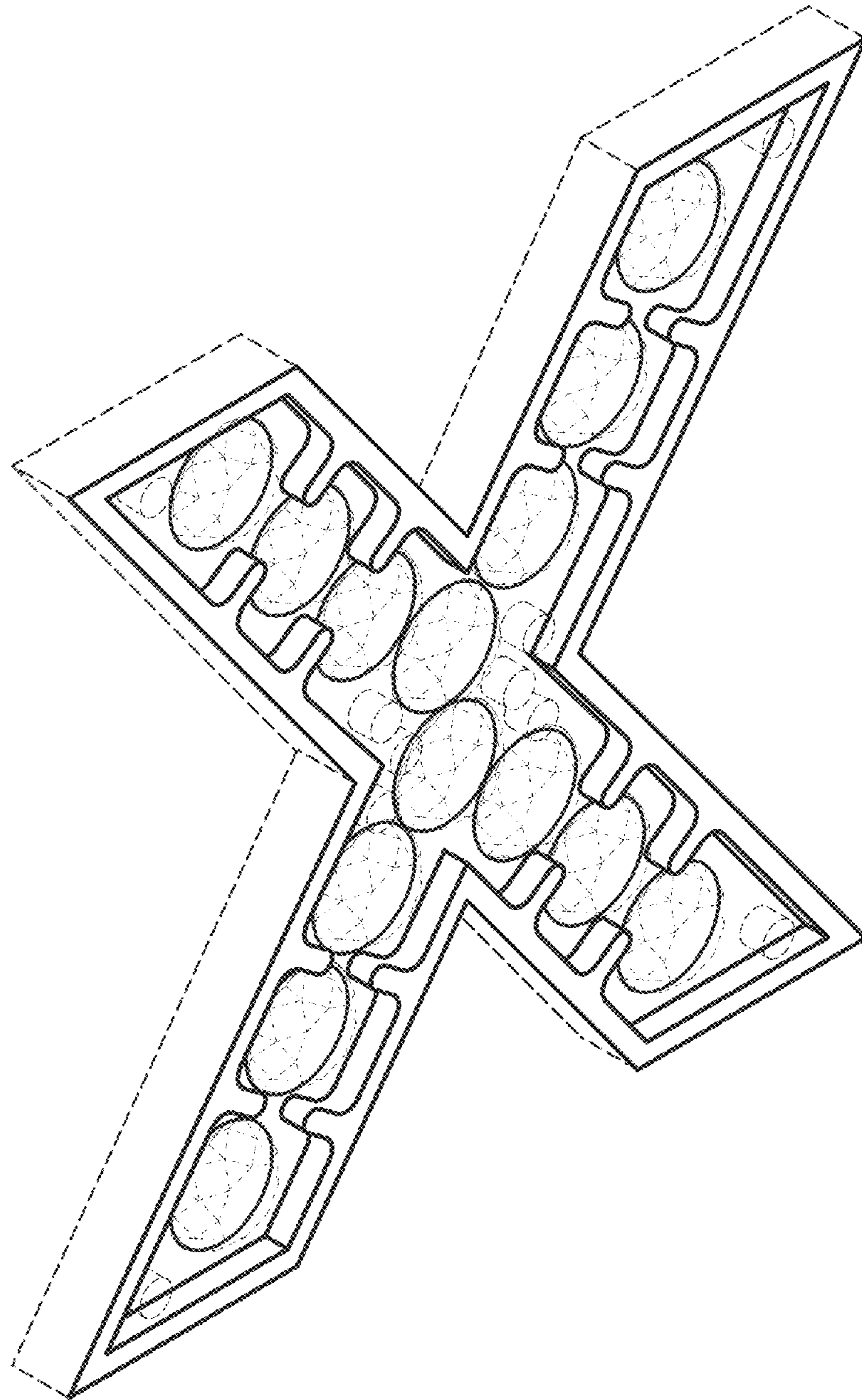

©2014 Valerie A. Vance

Fig. 12

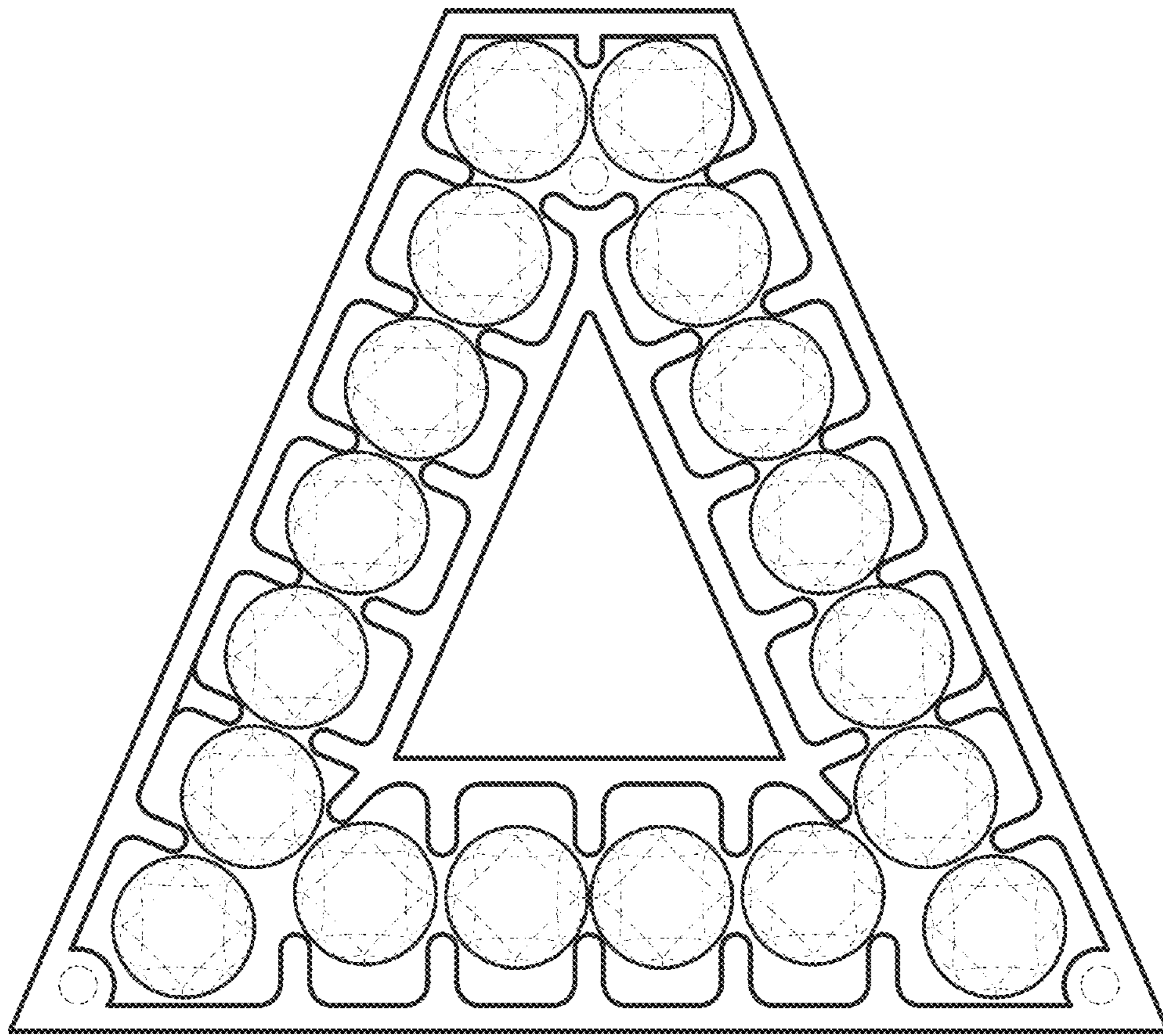

©2014 Valerie A. Vance

Fig. 13

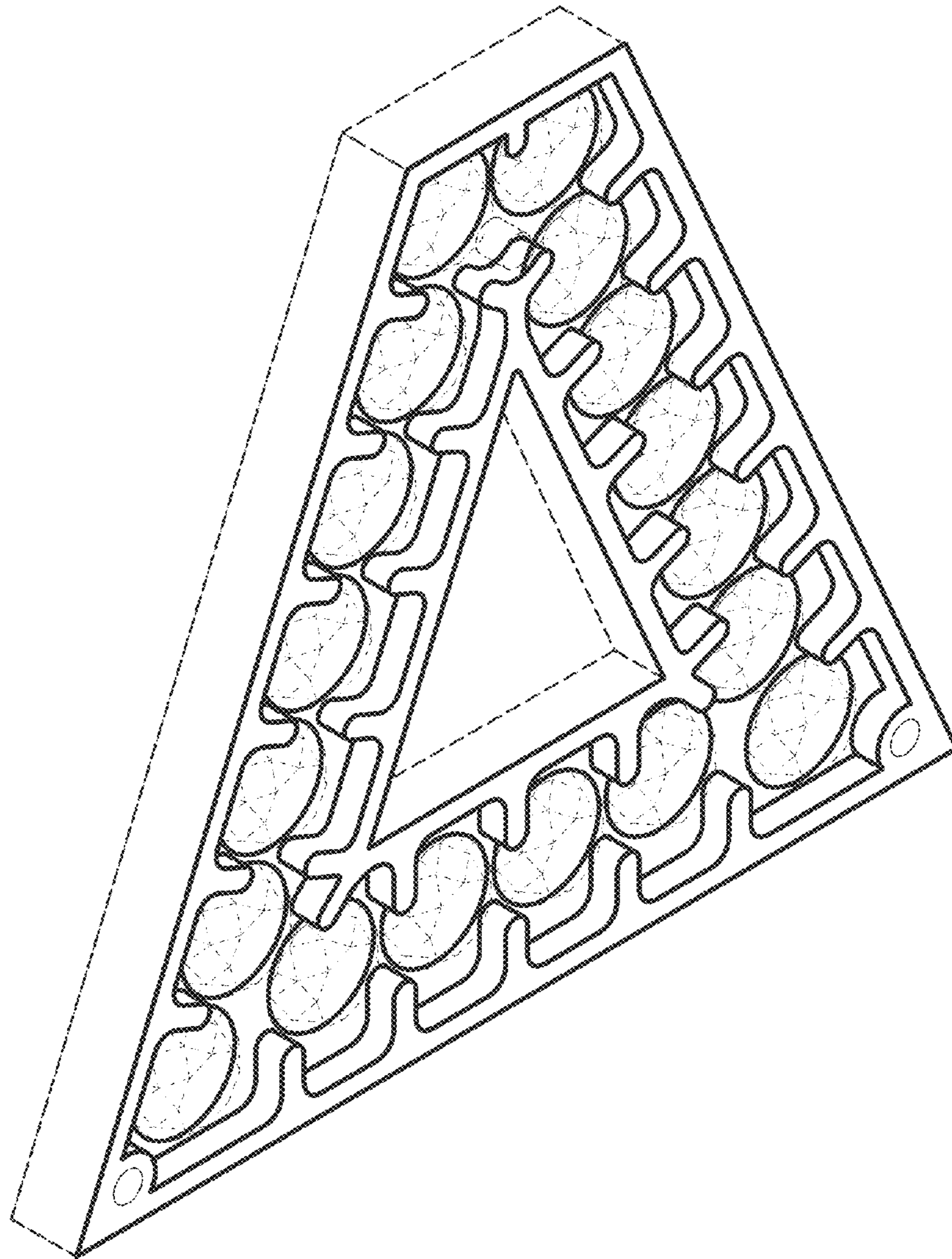

©2014 Valerie A. Vance

Fig. 14



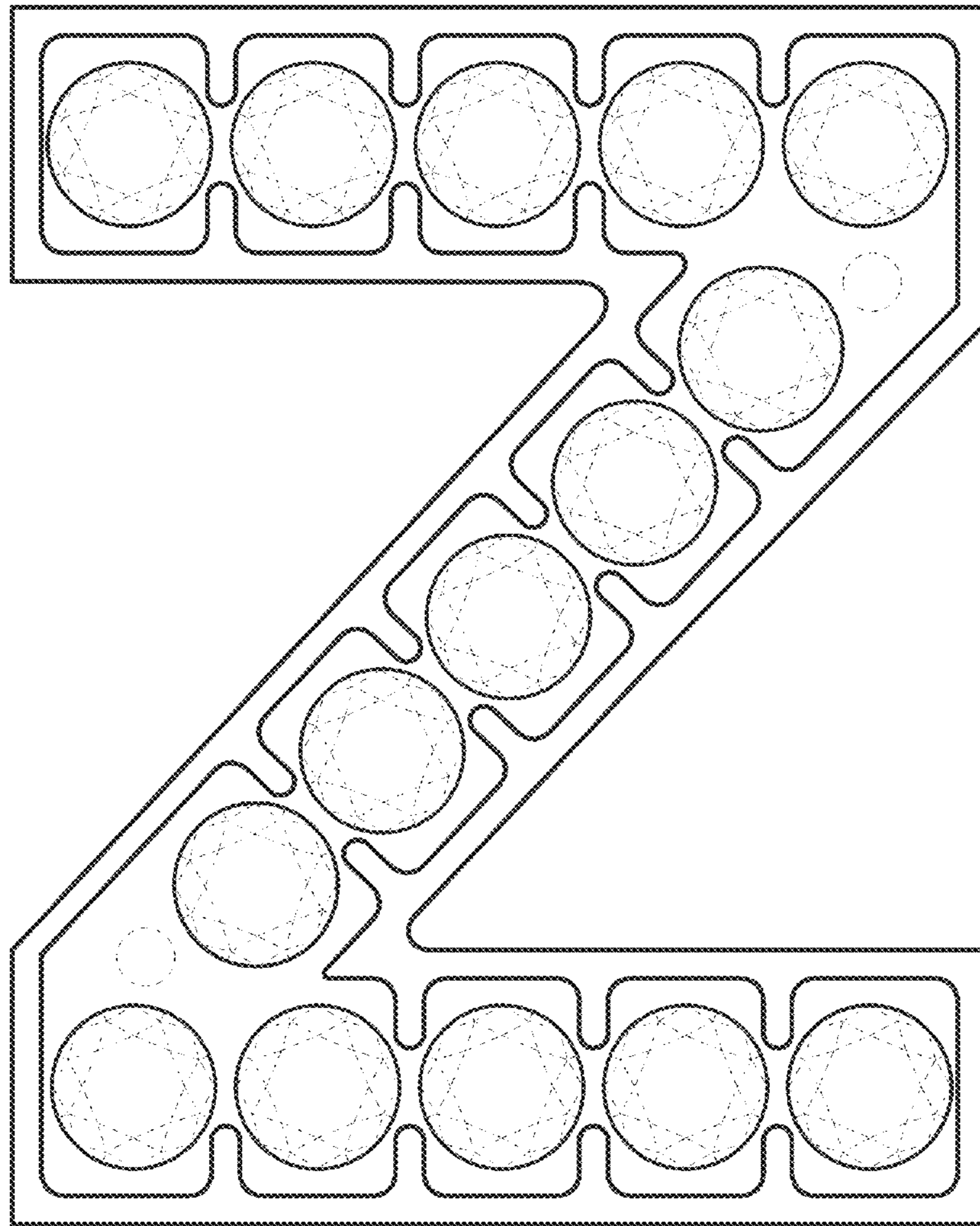

©2014 Valerie A. Vance

Fig. 15

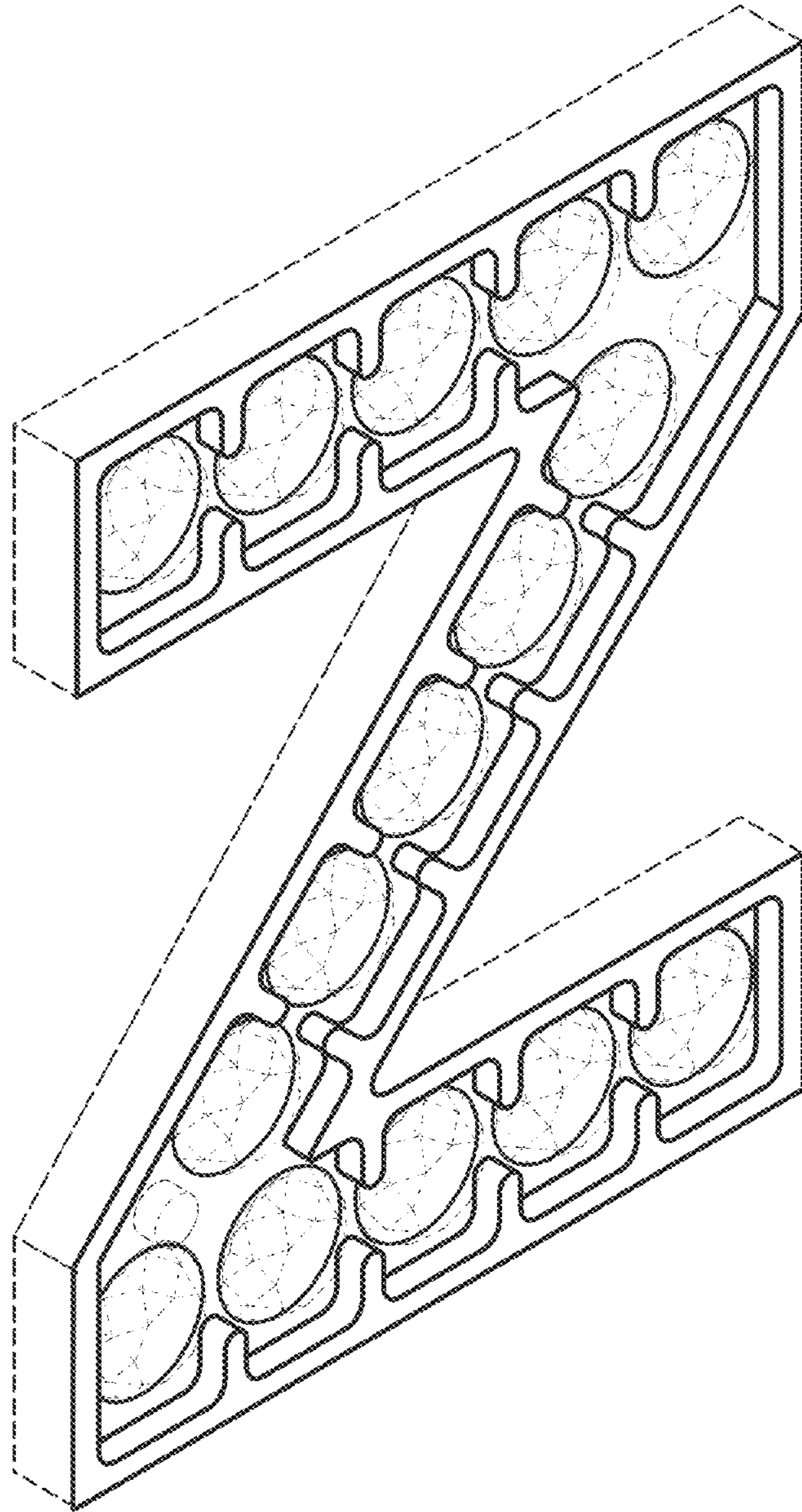

©2014 Valerie A. Vance

Fig. 16

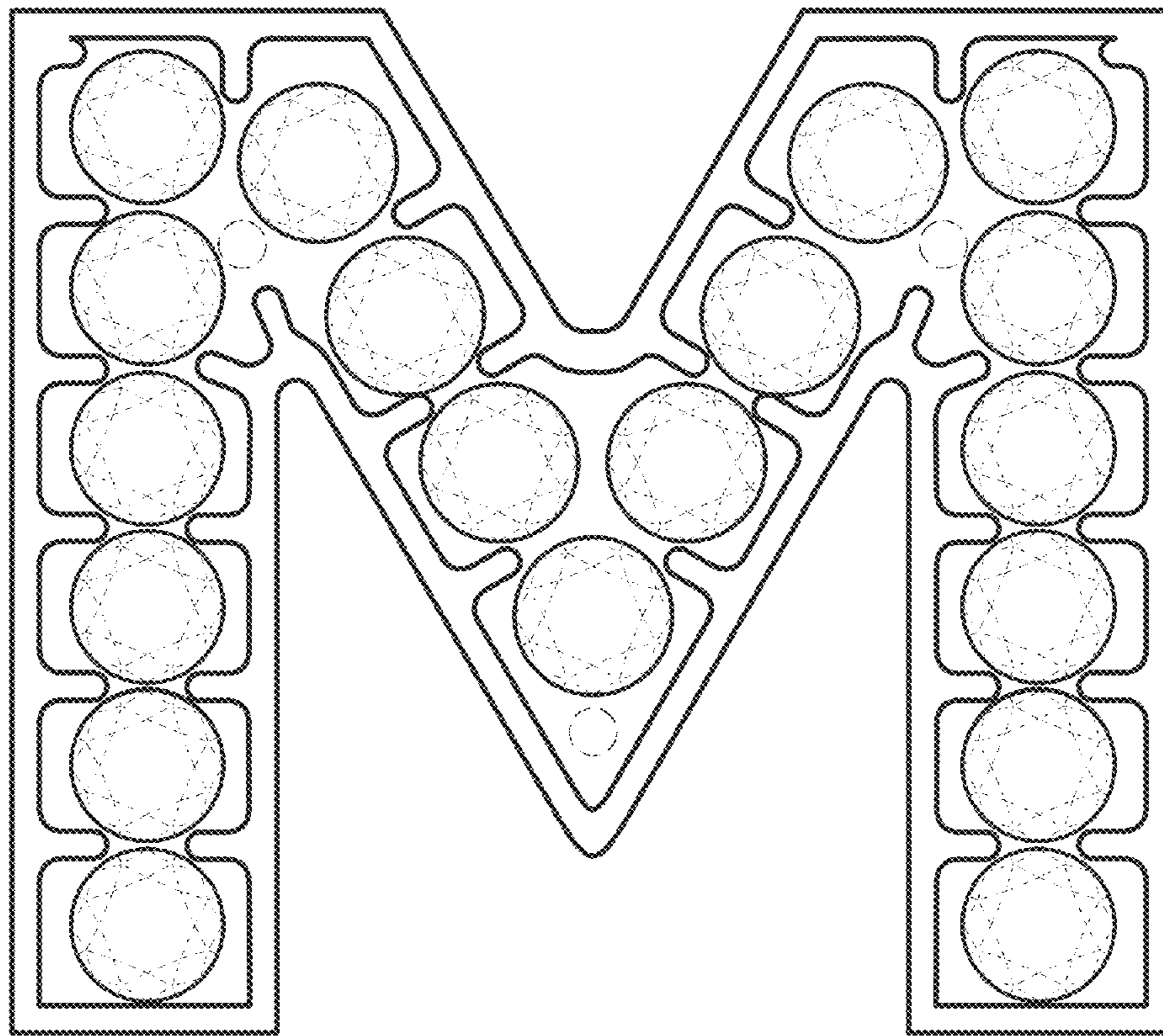

©2014 Valerie A. Vance

Fig. 17

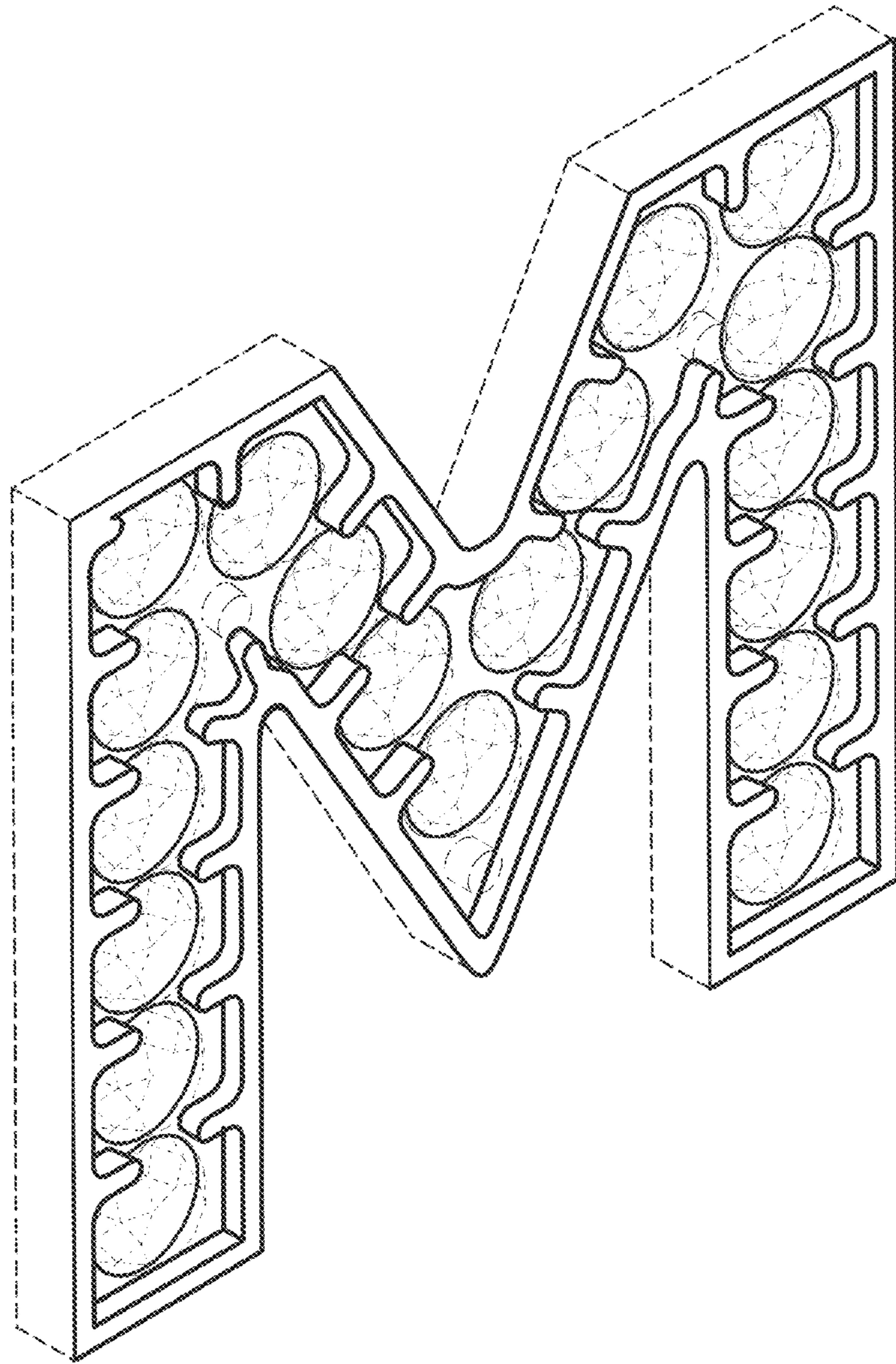

©2014 Valerie A. Vance

Fig. 18