



US00D760599S

(12) **United States Design Patent**
Jayakaran et al.

(10) **Patent No.:** **US D760,599 S**
(45) **Date of Patent:** **** Jul. 5, 2016**

(54) **BLISTER PACKAGE**

- (71) Applicant: **The Procter & Gamble Company**,
Cincinnati, OH (US)
- (72) Inventors: **Jacob Karun Jayakaran**, Cincinnati,
OH (US); **Raf Gustaaf Alfons De Geyter**,
Herk-de-Stad (BE); **Satoshi Fukuda**,
Kobe (JP); **Masahiko Ishimoto**,
Kanonji (JP)
- (73) Assignee: **The Procter & Gamble Company**,
Cincinnati, OH (US)
- (**) Term: **14 Years**
- (21) Appl. No.: **29/488,105**
- (22) Filed: **Apr. 16, 2014**
- (51) **LOC (10) Cl.** **09-01**
- (52) **U.S. Cl.**
USPC **D9/732**
- (58) **Field of Classification Search**
USPC D9/414, 415, 418, 424, 430, 715, 722,
D9/730, 732; 206/216, 229, 461, 471,
206/524.1, 525.1, 531, 532, 538, 562, 563,
206/569, 570, 586, 822; D3/201, 202, 269;
D24/227
CPC .. B65D 75/327; B65D 75/36; B65D 2585/56;
B65D 75/367; B65D 2575/3245; B65D
2581/055; B65D 83/0445; B65D 2575/3236;
B65D 73/0092; B65D 1/36; B65D 81/113;
B65D 75/30; B65D 51/28; B65D 85/00;
B65D 2543/00296; B65D 5/4204; B65D
75/22; B65D 2575/366; B65D 75/38; B65D
5/5038; B65D 2575/3218; B65D 75/323;
B65D 75/58; B65D 81/133; B65D
2543/00194; B65D 2575/565; B65D 73/00;
B65D 81/02; B65D 85/60; B65D 75/34;
B65D 81/24; B65D 83/00; B65D 71/00;
B65D 5/5088; B65D 73/0007; B65D 73/0078;
B65D 75/5811; B65D 75/5833; B65D
2519/00273; B65D 1/0223

See application file for complete search history.

(56) **References Cited**

U.S. PATENT DOCUMENTS

- 3,463,308 A * 8/1969 Karl-Heinz B65D 73/0057
206/380
- 3,921,805 A * 11/1975 Compere B65D 75/327
206/469
- 4,371,080 A * 2/1983 Haines B65D 75/366
206/531
- 4,450,959 A * 5/1984 Sommer B65D 75/327
206/461
- D360,826 S * 8/1995 Harman D9/415
- D371,071 S * 6/1996 Ford D9/415
- 5,551,567 A * 9/1996 Malone B65D 75/327
206/469
- 6,076,675 A * 6/2000 Pawlowski A47F 7/03
206/459.5
- D506,680 S * 6/2005 Saelzer D9/732
- D537,735 S * 3/2007 Fountoulakis D9/415
- D544,788 S * 6/2007 Brittain D9/415
- D569,575 S * 5/2008 Yalinkaya D99/34
- D570,075 S * 5/2008 Wood D99/34

(Continued)

Primary Examiner — Derrick Holland

Assistant Examiner — Lauren Calve

(74) *Attorney, Agent, or Firm* — Gregory S.
Darley-Emerson; Leonard W Lewis; Steve W Miller

(57) **CLAIM**

The ornamental design for a blister package, as shown and described.

DESCRIPTION

FIG. 1 is an isometric view of a blister package, embodying the new design;
 FIG. 2 is a front view thereof;
 FIG. 3 is a back view thereof;
 FIG. 4 is a right view thereof;
 FIG. 5 is a left view thereof;
 FIG. 6 is a top view thereof; and,
 FIG. 7 is a bottom view thereof.
 The broken lines shown represent unclaimed subject matter and form no part of the claimed design.

1 Claim, 3 Drawing Sheets

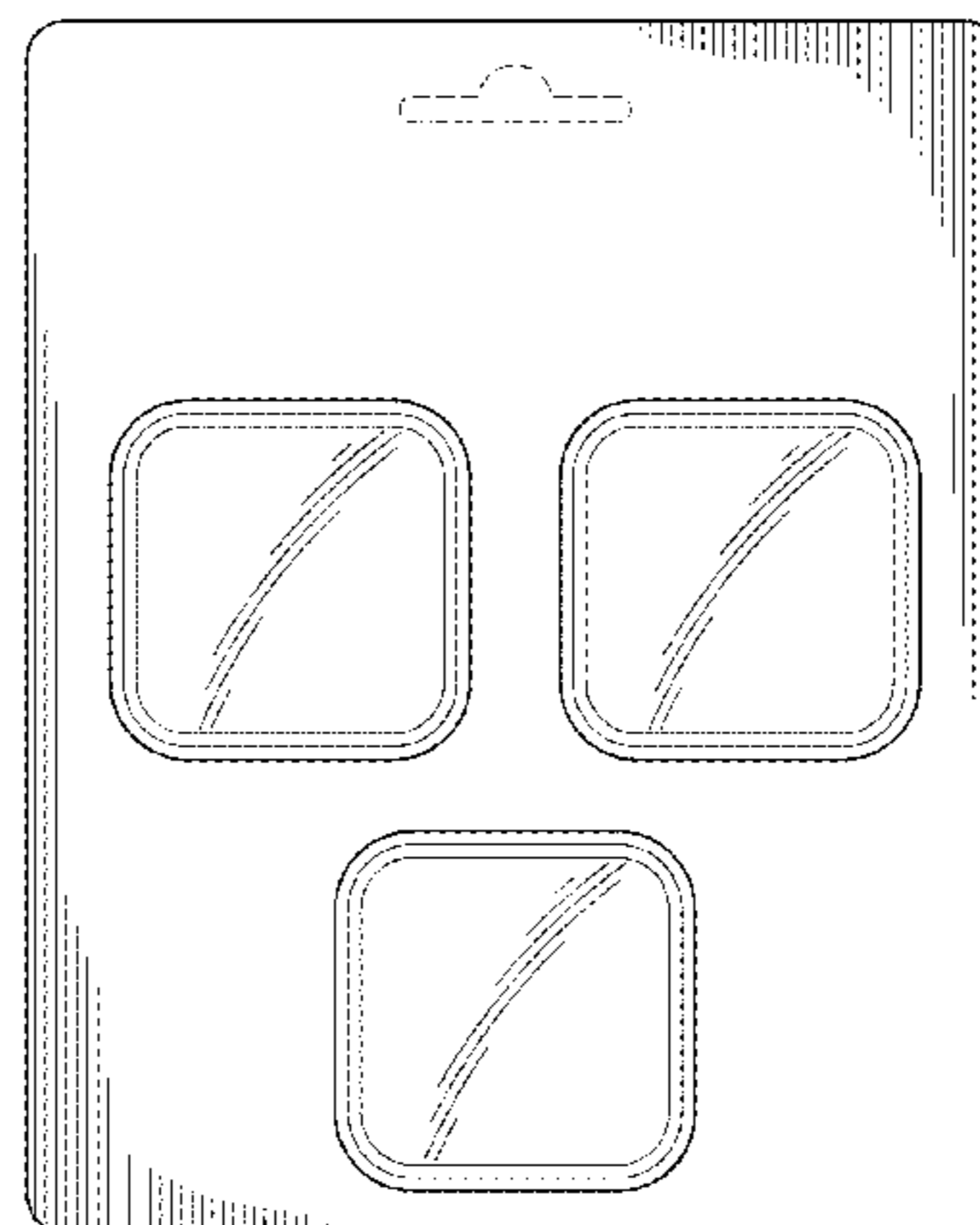
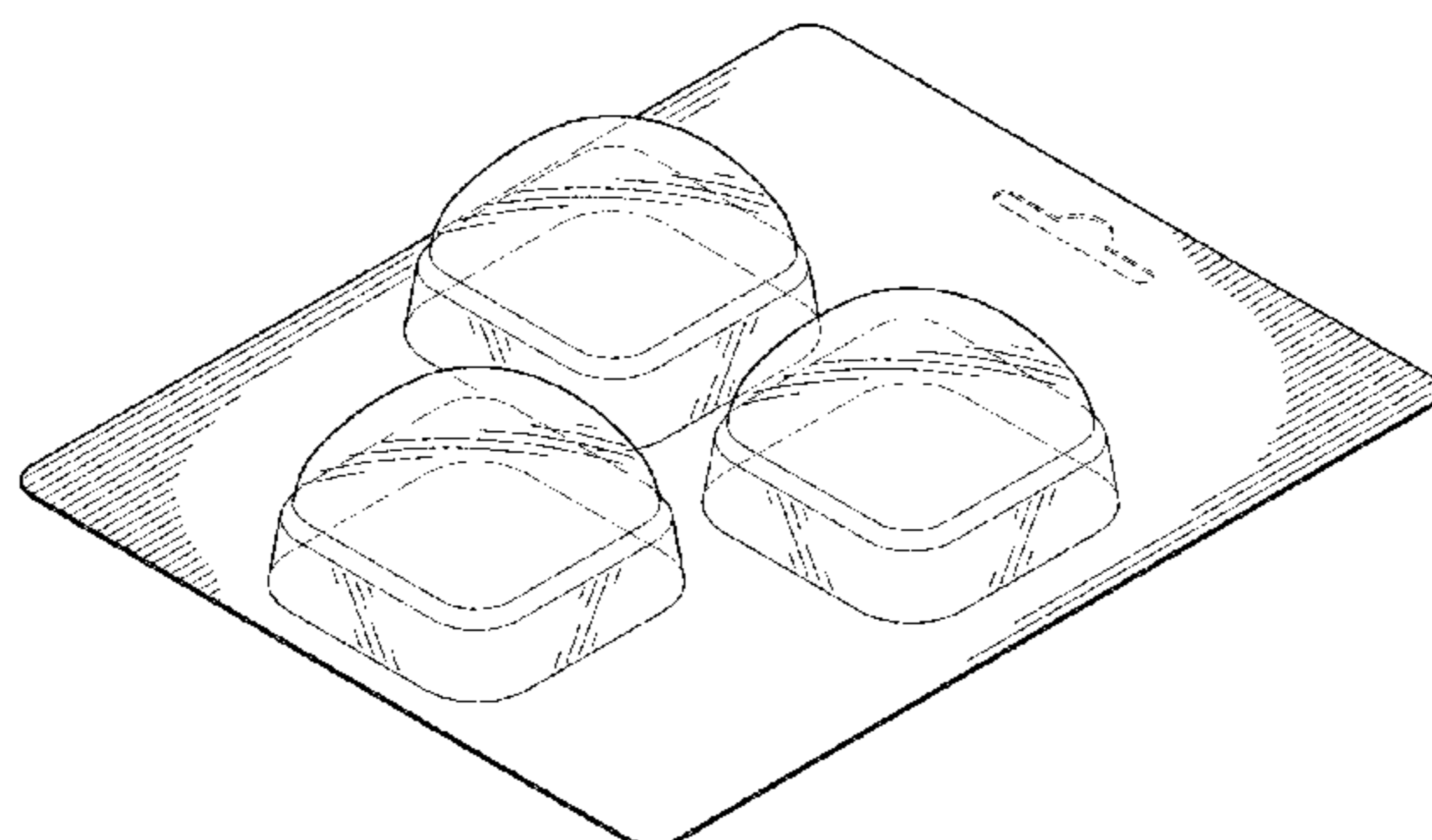

US D760,599 S

Page 2

(56)

References Cited

U.S. PATENT DOCUMENTS

D588,012 S *	3/2009	Navarro	D9/415	D727,721 S *	4/2015	Mayer	D9/415
D628,090 S *	11/2010	Stuiber	D9/732	D734,143 S *	7/2015	Mayer	D9/415
D637,073 S *	5/2011	Morcos	D9/415	2006/0127540 A1 *	6/2006	Keckeis	B65D 81/3294 426/120
D649,885 S *	12/2011	Stuiber	D9/732	2006/0249422 A1 *	11/2006	Bates, Jr.	B65D 75/367 206/532
D682,084 S *	5/2013	Pierre	D9/415	2010/0000899 A1 *	1/2010	Burg	B65D 83/0463 206/459.1
D706,622 S *	6/2014	Bischoff	D9/425	2013/0160408 A1 *	6/2013	Neff	B65D 75/323 53/492
D707,117 S *	6/2014	Leclerc	D9/415					

* cited by examiner

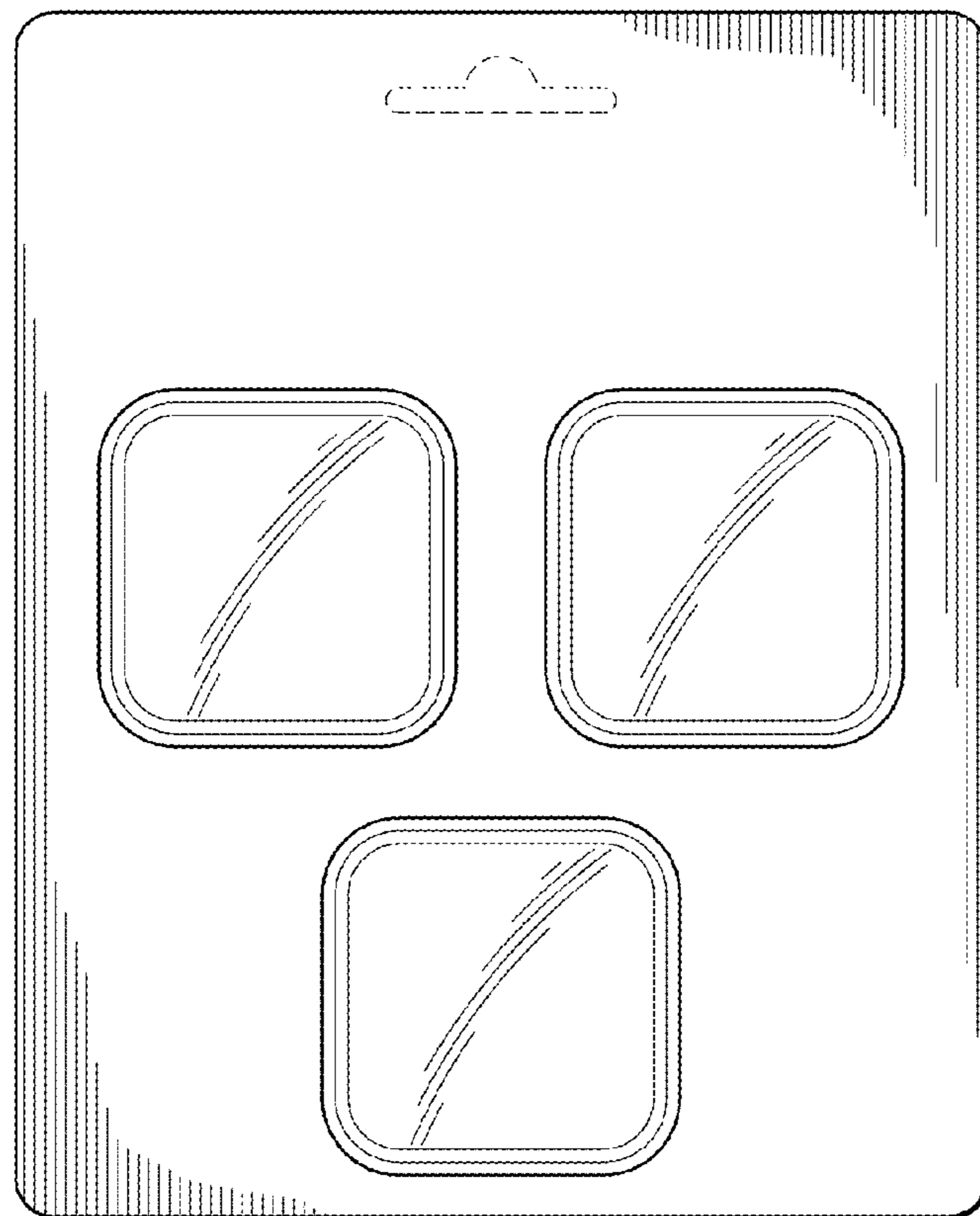
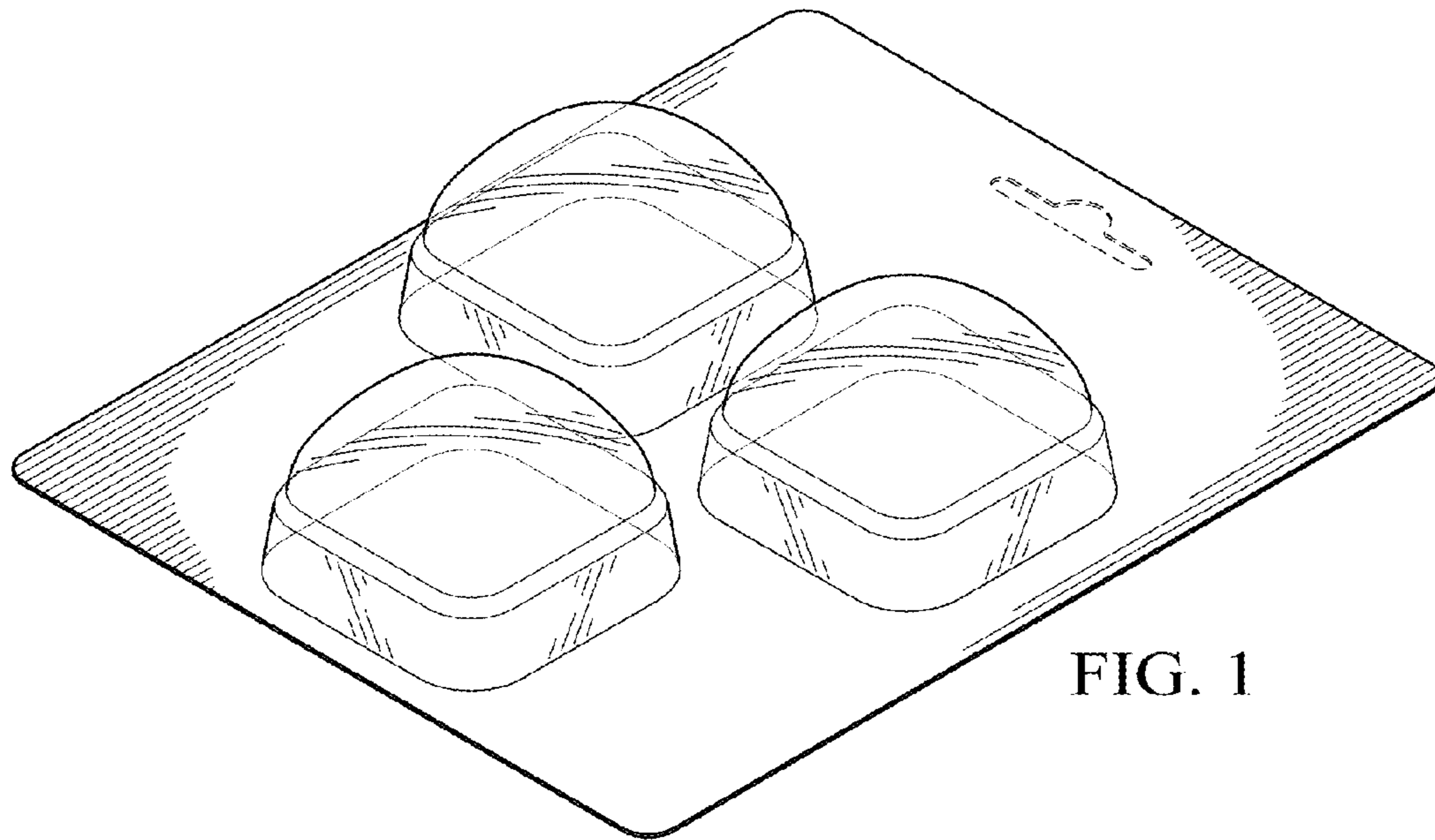

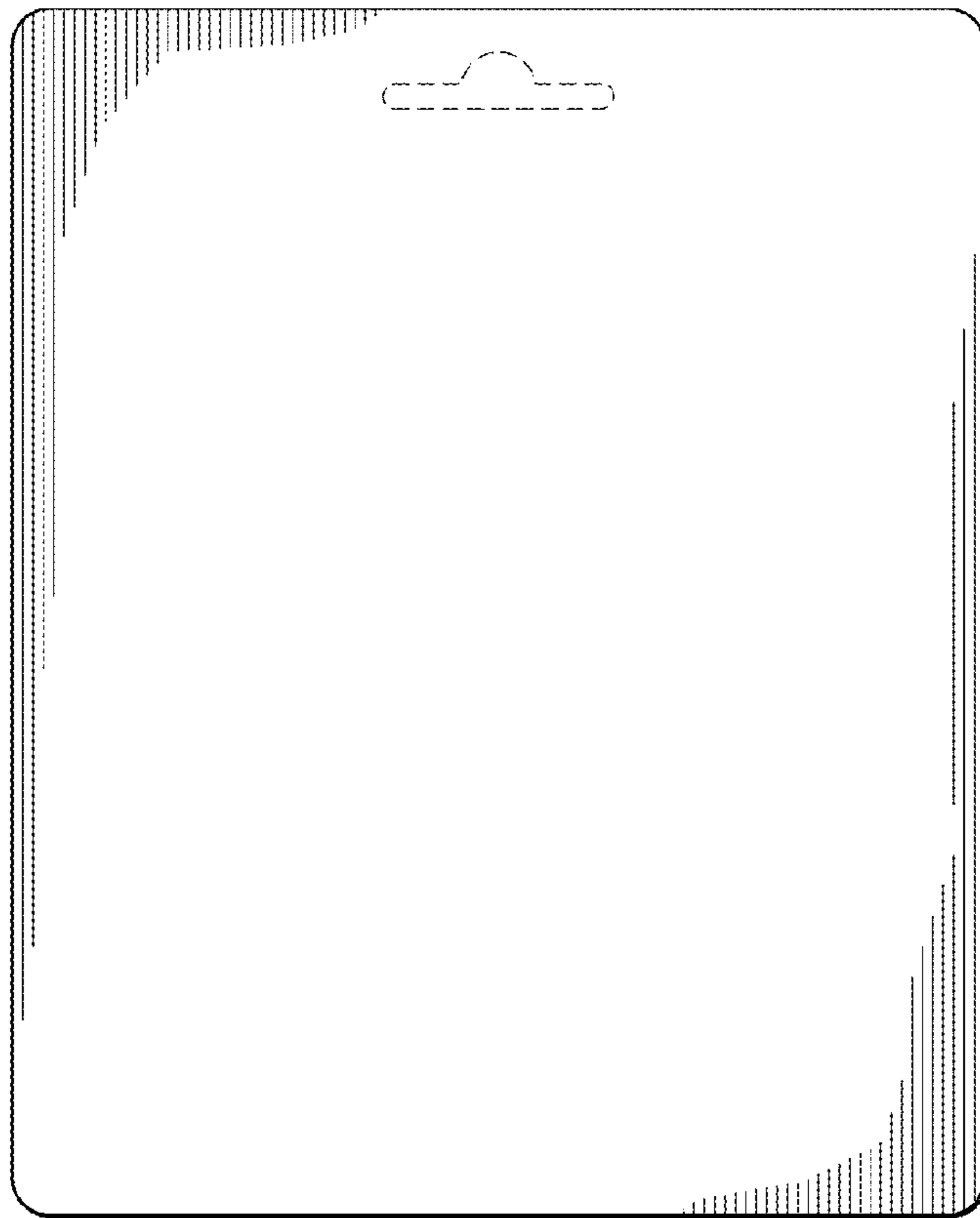

FIG. 3

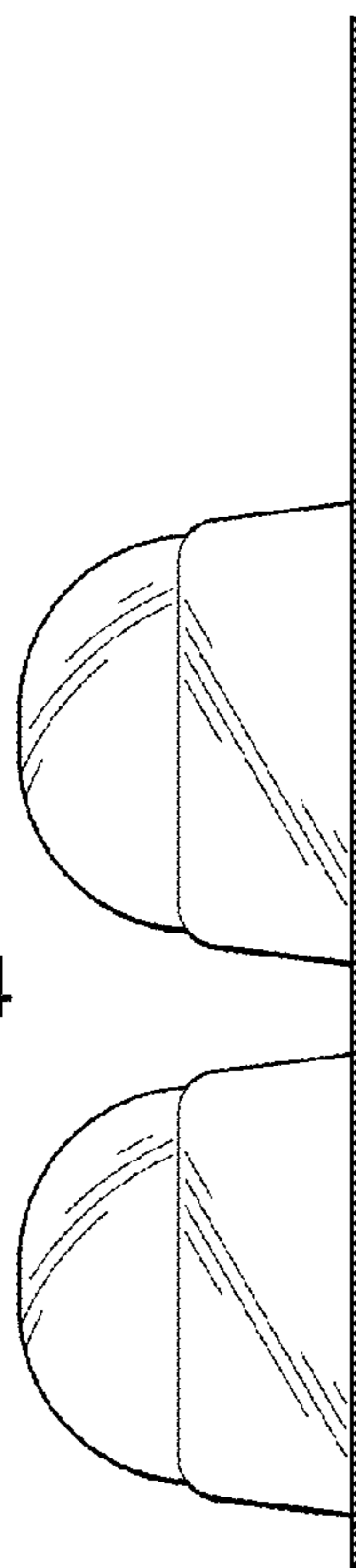

FIG. 4

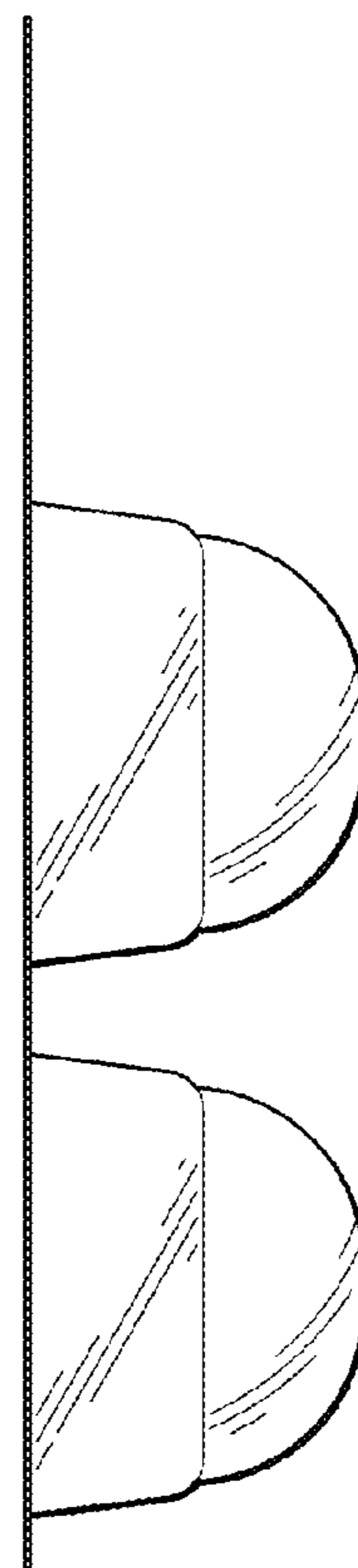

FIG. 5

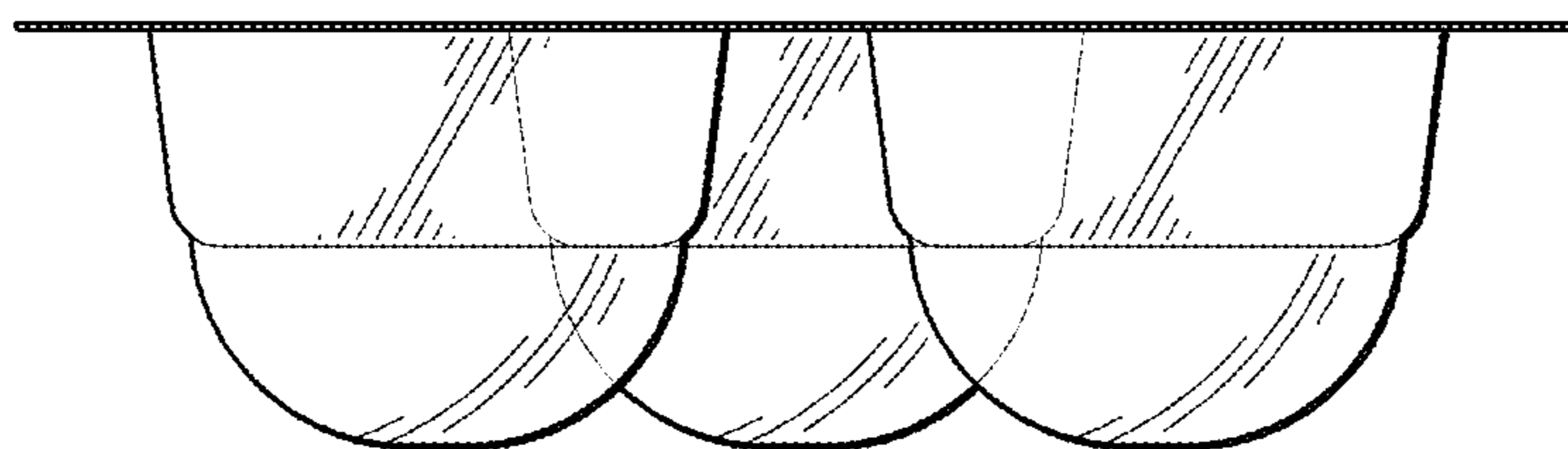

FIG. 6

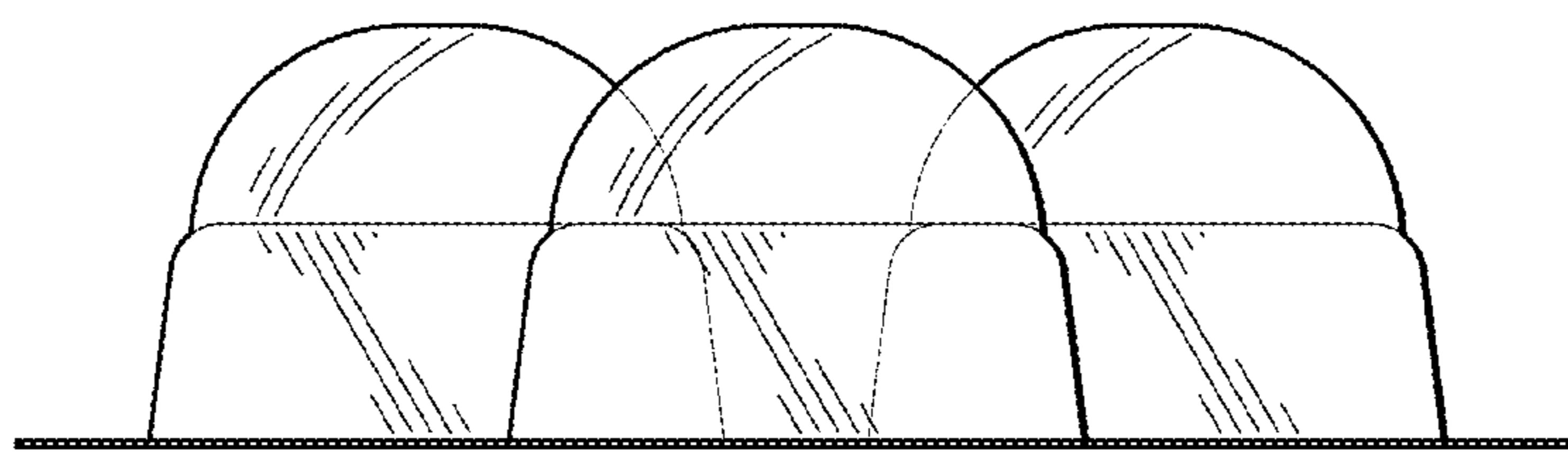

FIG. 7