



US00D760591S

(12) **United States Design Patent**
Groglopo Favetto et al.

(10) **Patent No.:** **US D760,591 S**

(45) **Date of Patent:** **** Jul. 5, 2016**

(54) **JAR**

(71) Applicant: **Conopco, Inc.**, Englewood Cliffs, NJ
(US)

(72) Inventors: **Pablo Ignacio Groglopo Favetto**,
Rotterdam (NL); **Marije Karen**
Luijendijk, Rotterdam (NL); **Gavin**
Thomas Schertzing, Chicago, IL (US)

(73) Assignee: **CONOPCO, INC.**, Englewood Cliffs,
NJ (US)

(**) Term: **14 Years**

(21) Appl. No.: **29/502,868**

(22) Filed: **Sep. 19, 2014**

(30) **Foreign Application Priority Data**

Mar. 19, 2014 (EM) 002428250-0001

(51) **LOC (10) Cl.** **09-01**

(52) **U.S. Cl.**
USPC **D9/500; D9/550**

(58) **Field of Classification Search**
USPC D9/500, 502, 503, 516, 549, 550, 558,
D9/715, 719
CPC B65D 1/00; B65D 1/02; B65D 1/10;
B65D 1/0223; B65D 1/243; B65D 23/00;
B65D 81/00; B65D 2501/00; B65D 2501/0009
See application file for complete search history.

(56) **References Cited**

U.S. PATENT DOCUMENTS

D236,433 S * 8/1975 Strand D9/500
3,940,004 A * 2/1976 Faulstich B65D 41/485
215/256
D241,011 S * 8/1976 Pentengill D9/500
D277,550 S * 2/1985 Campbell D9/500

D284,269 S * 6/1986 Goettner D9/500
D288,906 S * 3/1987 Strand D9/533
D345,503 S * 3/1994 Murphy D7/615
D529,389 S * 10/2006 Trude D9/538
D595,580 S * 7/2009 Cordero D9/516
D606,870 S * 12/2009 Kaminski D9/552
D611,817 S * 3/2010 Simmons D9/449
D633,794 S * 3/2011 Cresswell D9/500
D697,408 S * 1/2014 Eble D9/502
2007/0289933 A1 * 12/2007 Weissmann B65D 1/101
215/42
2009/0188888 A1 * 7/2009 Penny B65D 1/0246
215/329

OTHER PUBLICATIONS

Co-Pending Application Groglopo Favetto, Titled: Lid, Filed Sep. 19, 2014.

* cited by examiner

Primary Examiner — Ian Simmons

Assistant Examiner — Keith Frank

(74) *Attorney, Agent, or Firm* — Foley & Lardner, LLP

(57) **CLAIM**

The ornamental design for a jar, as shown and described.

DESCRIPTION

FIG. 1 is a perspective view from above and one side;
FIG. 2 is a front elevational view thereof;
FIG. 3 is a rear elevational view thereof;
FIG. 4 is a side elevational view thereof
FIG. 5 is a side elevational view thereof;
FIG. 6 is a top plan view thereof; and,
FIG. 7 is a bottom plan view.

The evenly-dashed broken lines in the drawings showing the jar illustrate the portions of the jar that form no part of the claim. The dash-dot-dash broken lines represent the bounds of the claim and form no part of the claim.

1 Claim, 7 Drawing Sheets

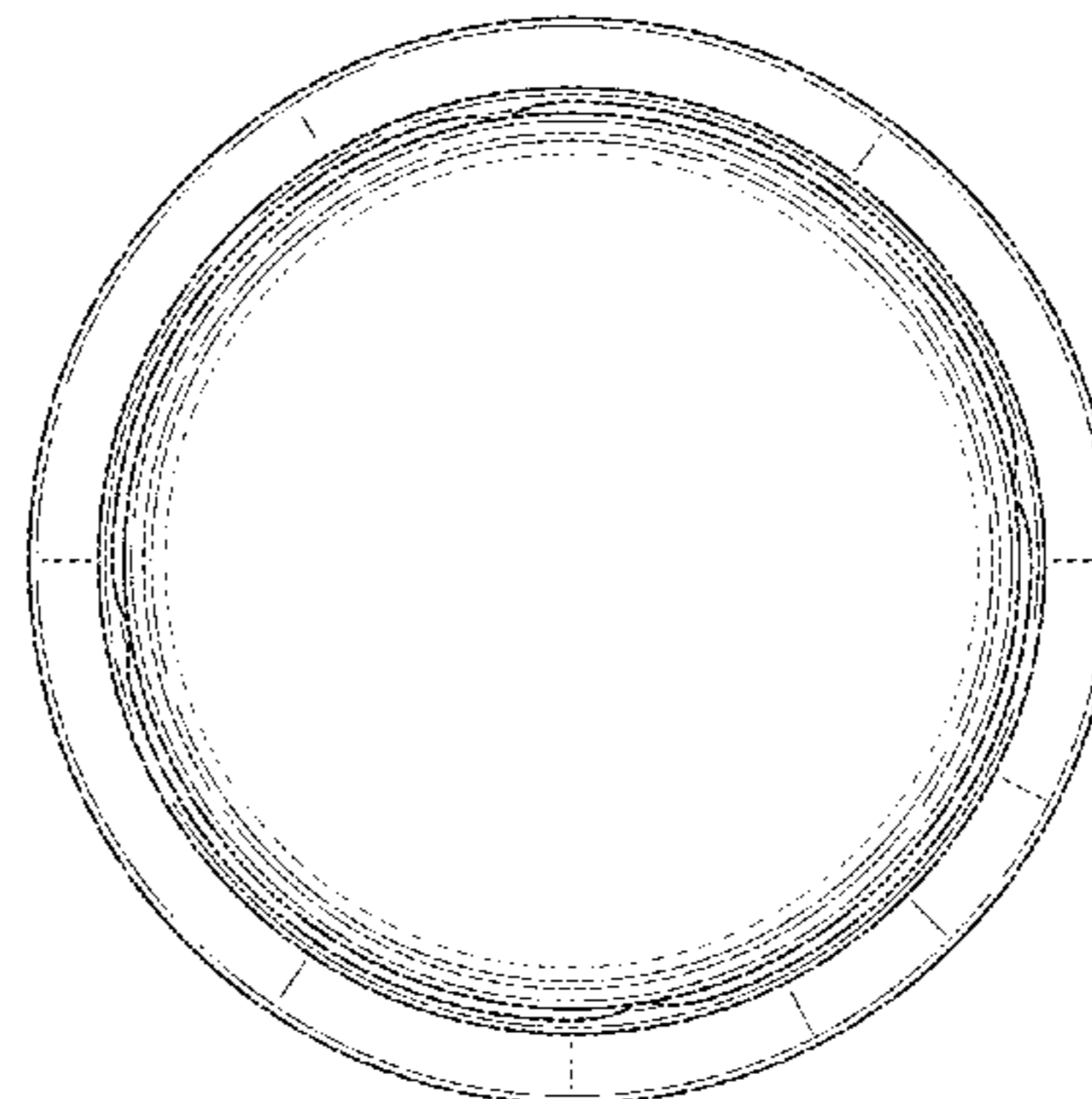
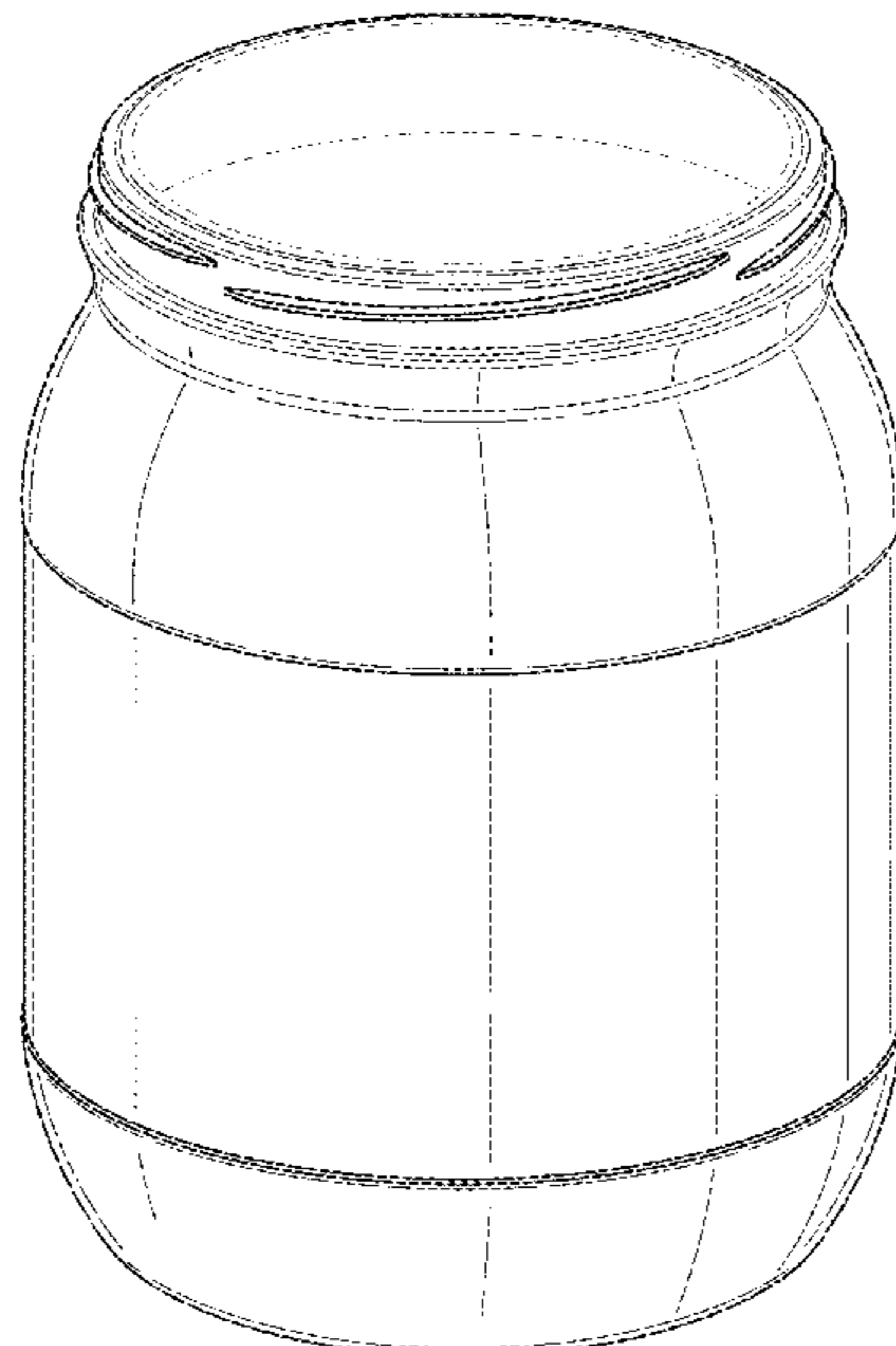

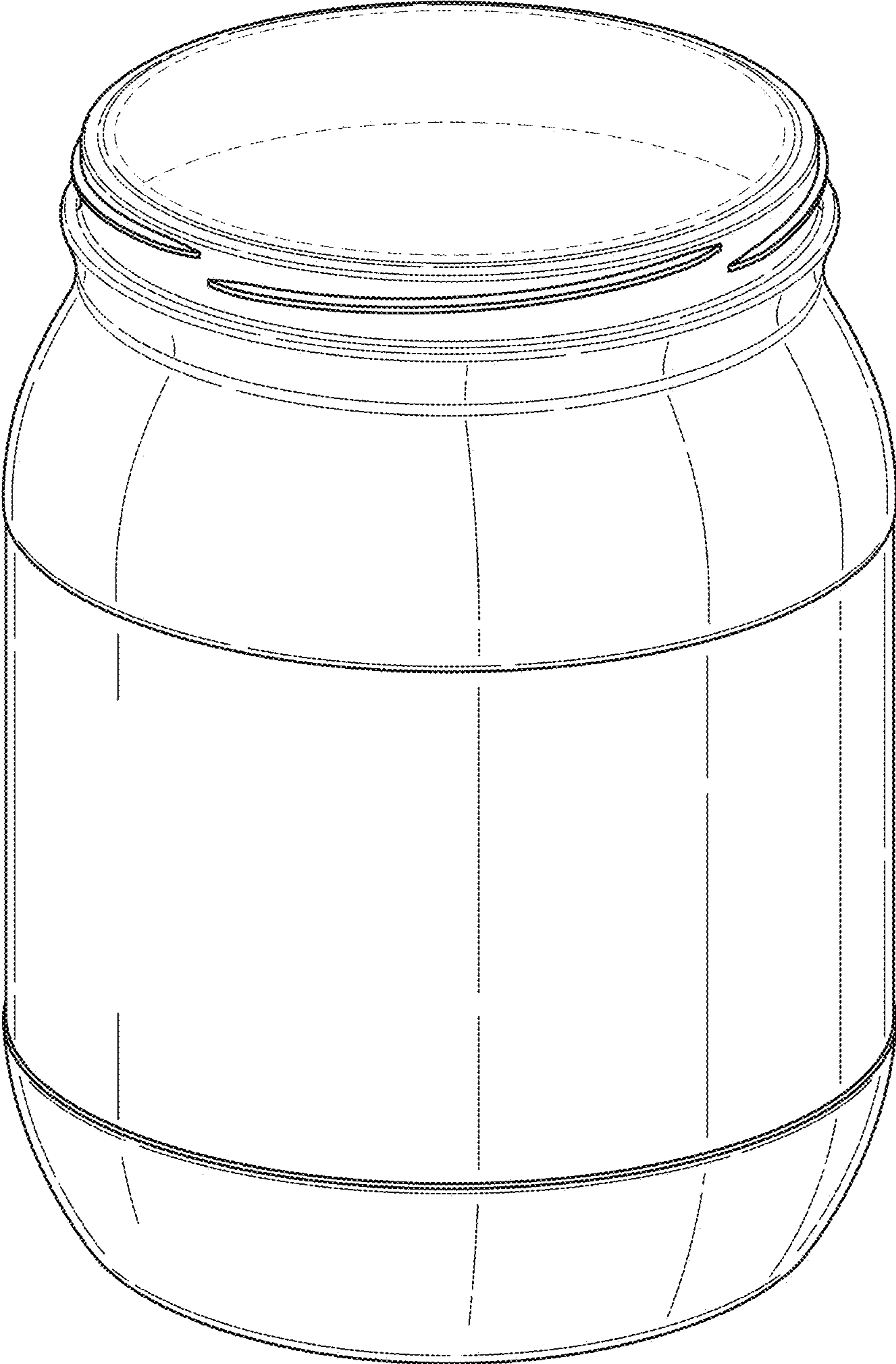

Fig. 1

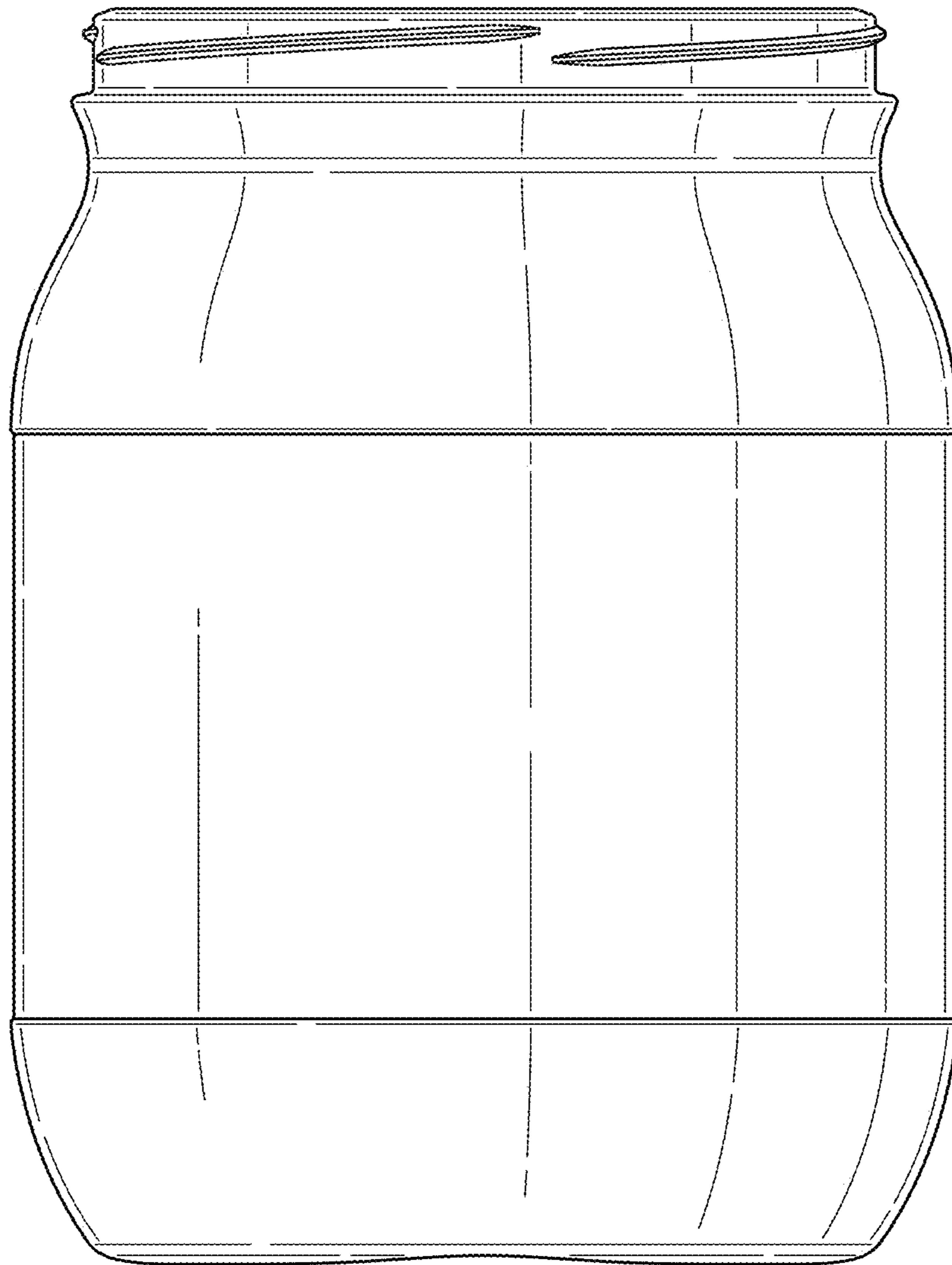

Fig. 2

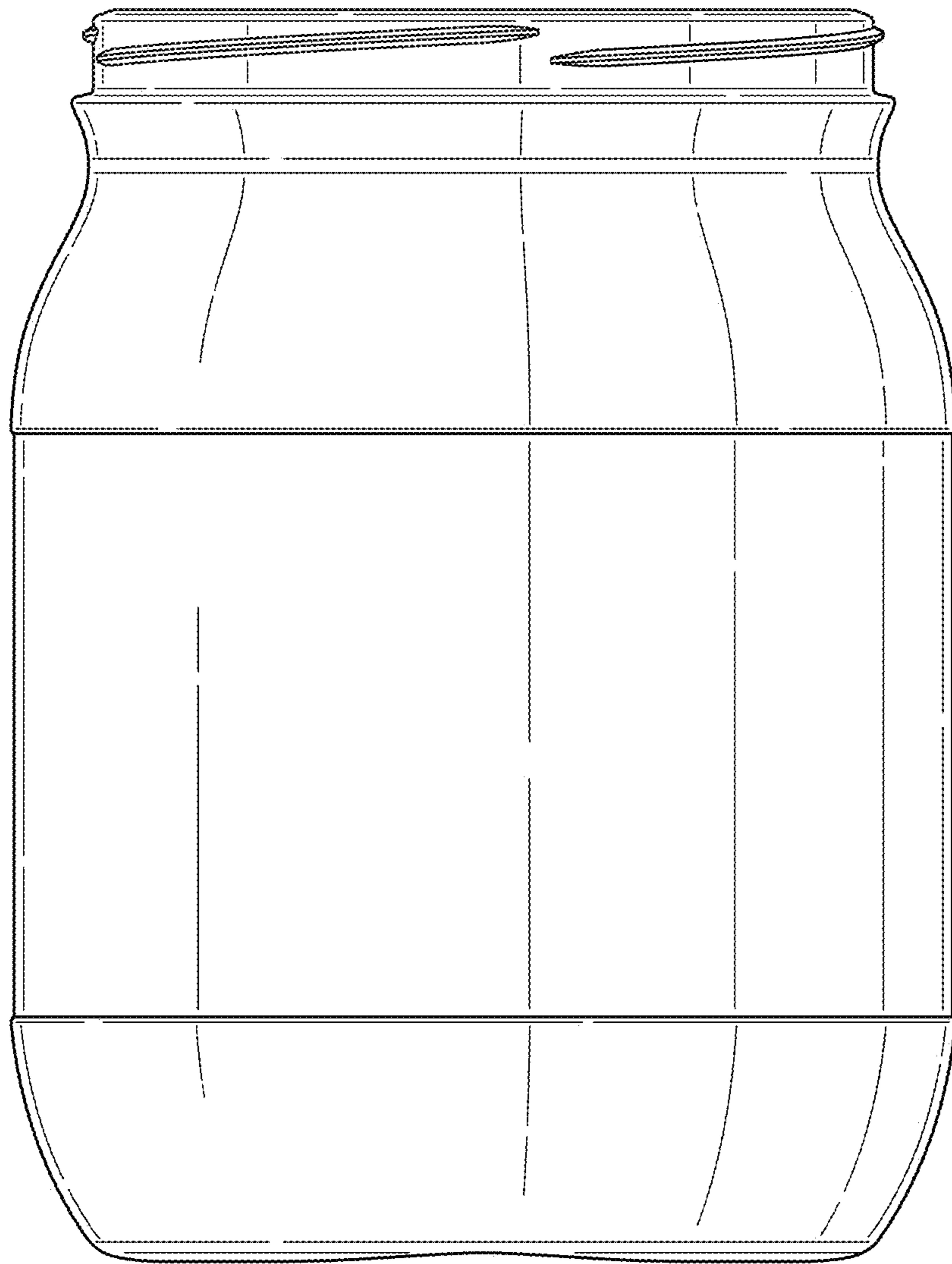

Fig. 3

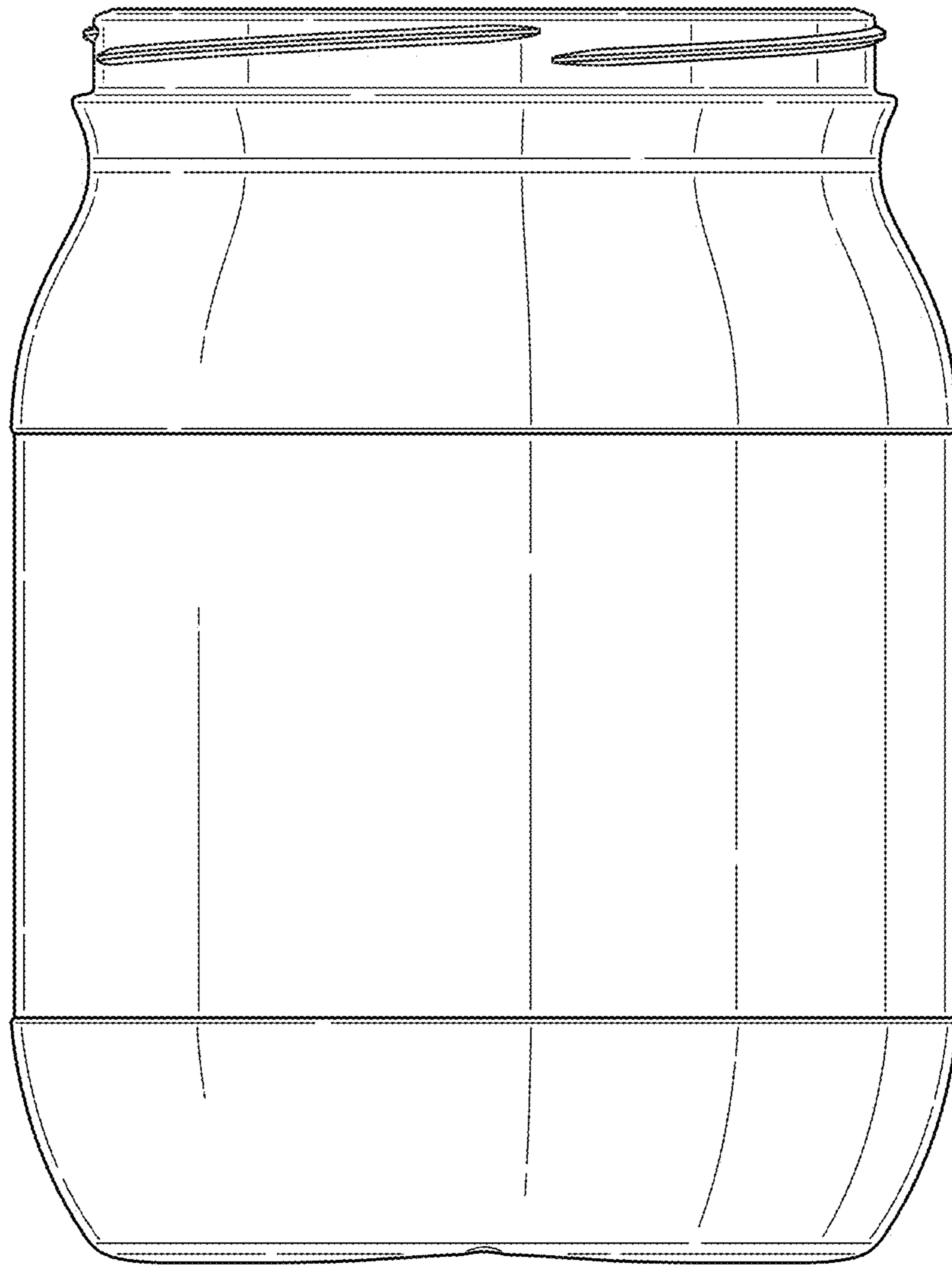

Fig. 4

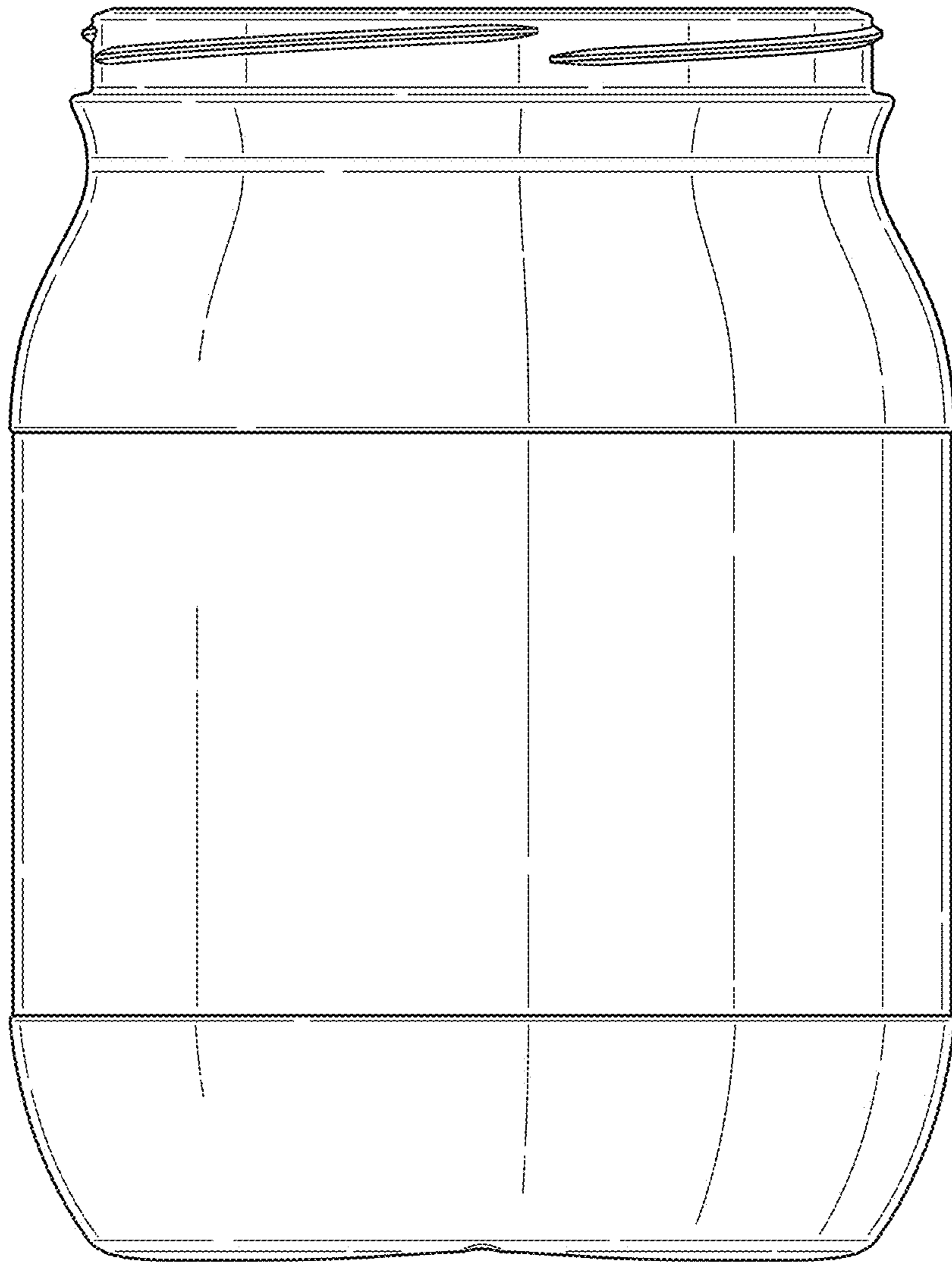

Fig. 5

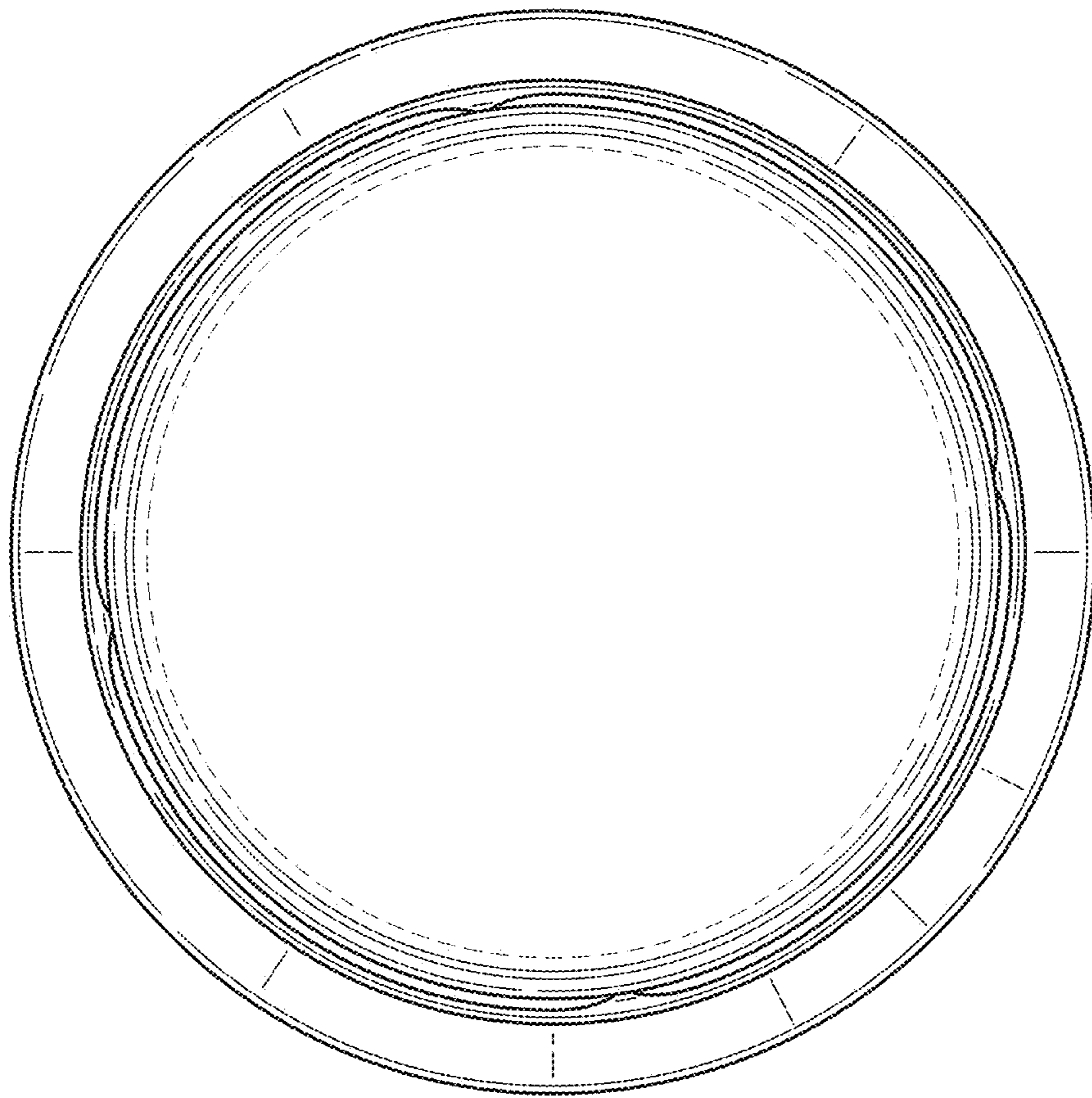

Fig. 6

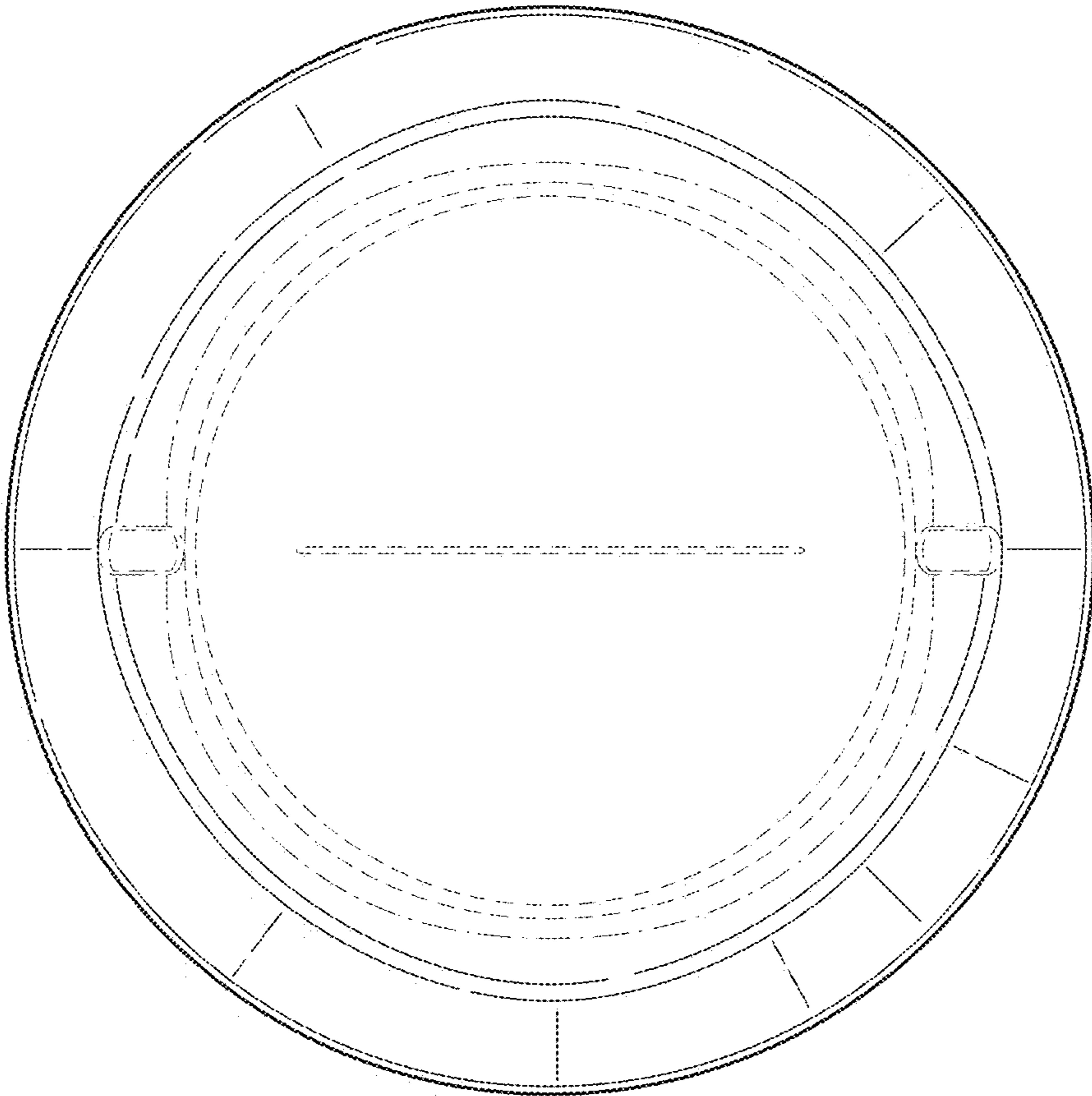

Fig. 7