



US00D760542S

(12) **United States Design Patent**
Vu et al.

(10) **Patent No.:** **US D760,542 S**
(45) **Date of Patent:** **** Jul. 5, 2016**

- (54) **MUG**
- (71) Applicant: **DE'LONGHI BRAUN HOUSEHOLD GMBH**, Neu-Isenburg (DE)
- (72) Inventors: **Duy Phong Vu**, Schwalbach am Taunus (DE); **Sven Wuttig**, Griesheim (DE); **Dennis Müller**, Frankfurt am Main (DE); **Britta Stockinger**, Frankfurt am Main (DE); **Markus Orthey**, Eltville am Rhein (DE)
- (73) Assignee: **DE'LONGHI BRAUN HOUSEHOLD GMBH**, Neu-Isenburg (DE)
- (**) Term: **14 Years**
- (21) Appl. No.: **29/519,381**
- (22) Filed: **Mar. 4, 2015**
- (51) **LOC (10) Cl.** **07-01**
- (52) **U.S. Cl.**
USPC **D7/511; D7/510; D7/532; D7/608**
- (58) **Field of Classification Search**
USPC **D7/509, 510, 511, 523, 532, 543, 505, D7/300.1, 607, 708, 619.1, 396.1, 396.2, D7/399, 387, 608; D9/503, 504, 520, 546, D9/572, 573, 574, 414, 432, 450, 524; D24/232, 216, 207, 206, 218, 224, 227, D24/229; D28/82, 76, 73, 83, 85; 220/592.16, 592.17, 700, 703, 377; D3/202, 302; D26/49**
CPC **A47G 19/22; A47G 19/2205; A47G 19/2255; A47G 19/2288; B65D 1/265; B65D 43/02; B65D 3/08**
See application file for complete search history.

(56) **References Cited**

U.S. PATENT DOCUMENTS

- 2,012,113 A * 8/1935 Thompson A47G 19/2205
215/363
- 2,075,721 A * 3/1937 Hommel B65D 25/48
220/717

- D107,994 S * 1/1938 Hansen D7/532
- 2,729,956 A * 1/1956 Gilbert B65D 25/44
141/390
- 2,861,716 A * 11/1958 Kramer B65D 1/265
215/228
- 3,185,341 A * 5/1965 Barbour B65D 25/48
220/260
- 5,657,572 A * 8/1997 Little A01K 97/26
220/8
- D421,877 S * 3/2000 La Torre D7/510
- D422,179 S * 4/2000 Stephenson D7/510
- D457,034 S * 5/2002 Bodum D7/510
- D495,208 S * 8/2004 Putnam D7/300.1
- D586,182 S * 2/2009 Trombly D7/509
- D622,545 S * 8/2010 Wahl D7/510
- D622,547 S * 8/2010 Carreno D7/510
- D627,196 S * 11/2010 George D7/510
- D632,525 S * 2/2011 George D7/396.2
- D651,853 S * 1/2012 Eyal D7/510
- D654,762 S * 2/2012 Gilbert D7/510
- D658,431 S * 5/2012 Gilbert D7/392.1
- D662,361 S * 6/2012 Eyal D7/510
- D671,787 S * 12/2012 Lin D7/300.1
- D683,184 S * 5/2013 Lin D7/316
- D709,322 S * 7/2014 Ross D7/399

(Continued)

Primary Examiner — Marianne Pandozzi

Assistant Examiner — Jae Liang

(74) *Attorney, Agent, or Firm* — Goodwin Procter LLP

(57) **CLAIM**

The ornamental design for a mug, as shown and described.

DESCRIPTION

- FIG. 1 is a top perspective view of a mug showing our new design;
- FIG. 2 is a front view of the mug;
- FIG. 3 is a rear view of the mug;
- FIG. 4 is a right side view of the mug;
- FIG. 5 is a left side view of the mug;
- FIG. 6 is a top view of the mug;
- FIG. 7 is a bottom view of the mug; and,
- FIG. 8 is a bottom perspective view of the mug.

1 Claim, 5 Drawing Sheets

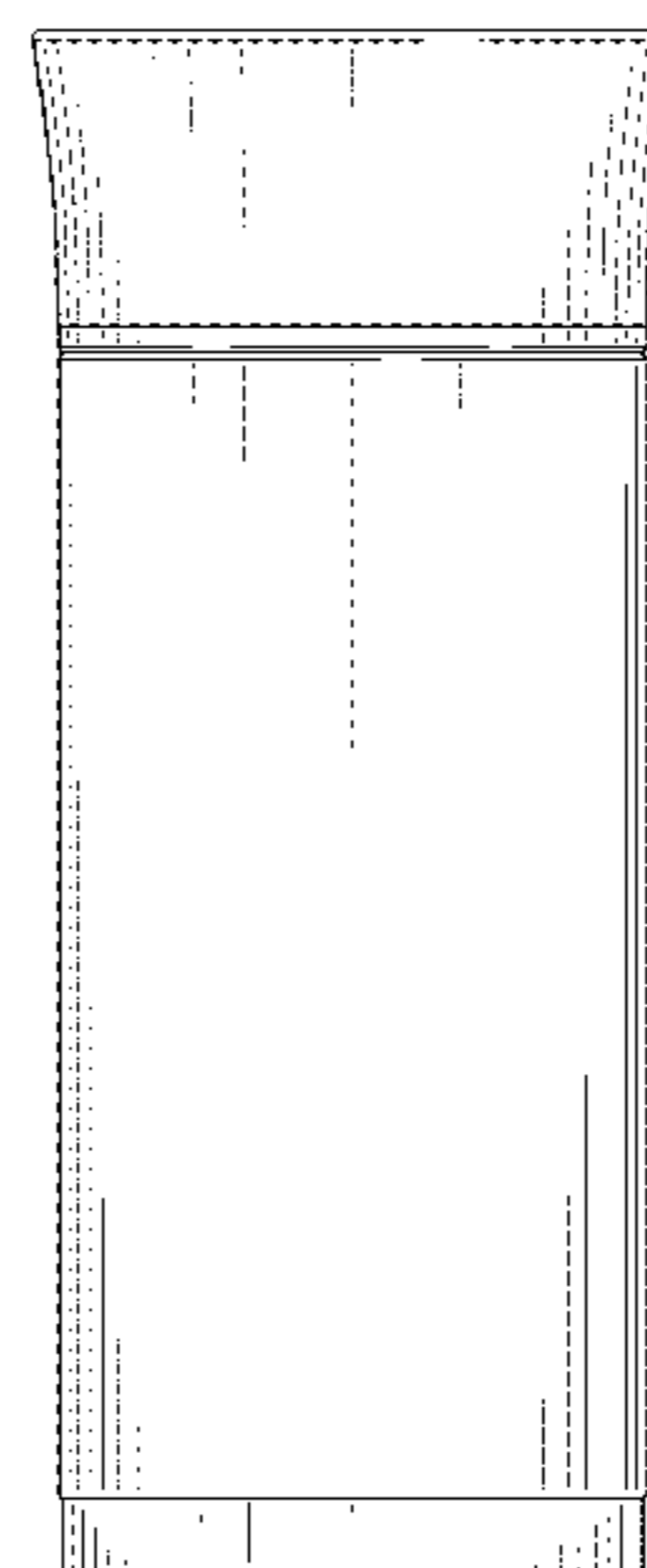
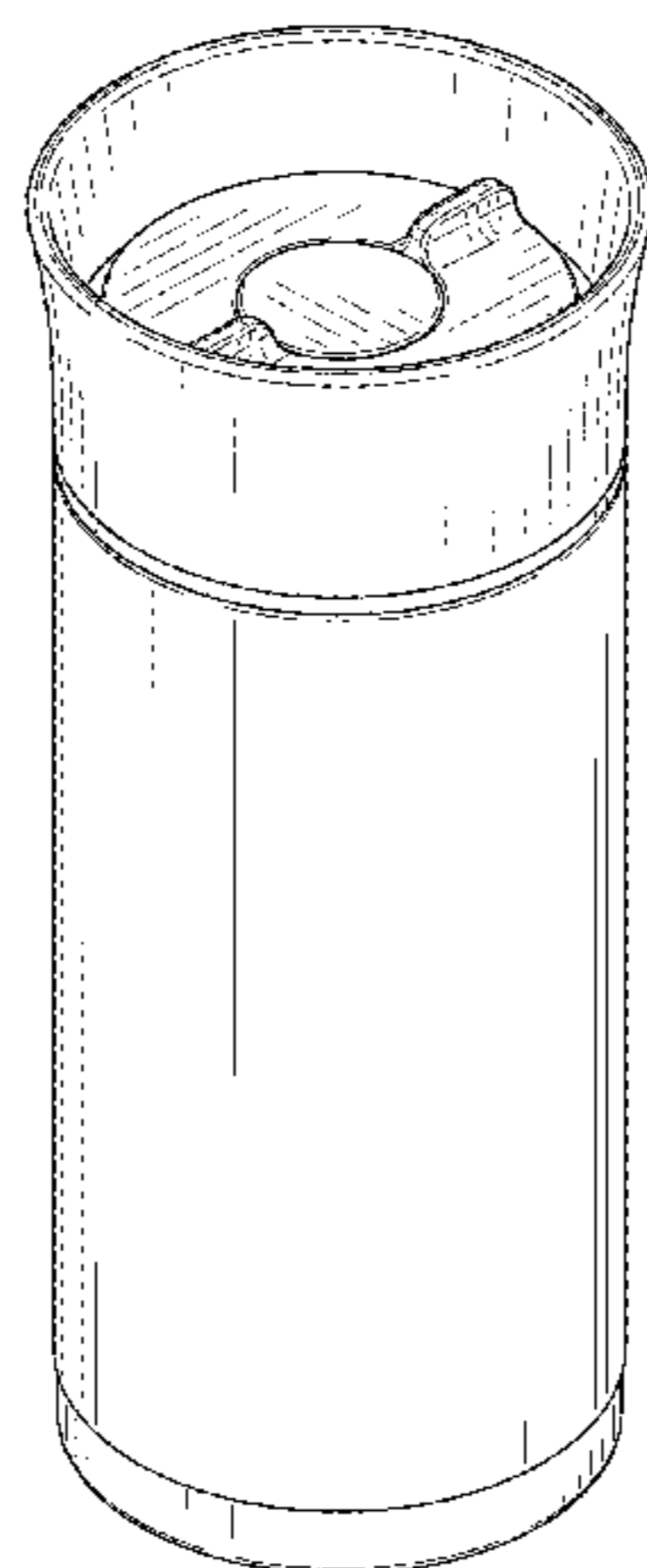

US D760,542 S

Page 2

(56)

References Cited

U.S. PATENT DOCUMENTS

D744,281 S *	12/2015	Dunn	D7/510
2011/0309094 A1 *	12/2011	Bodum	A47G 19/2272 220/715
D727,681 S *	4/2015	Osgood	D7/392.1

* cited by examiner

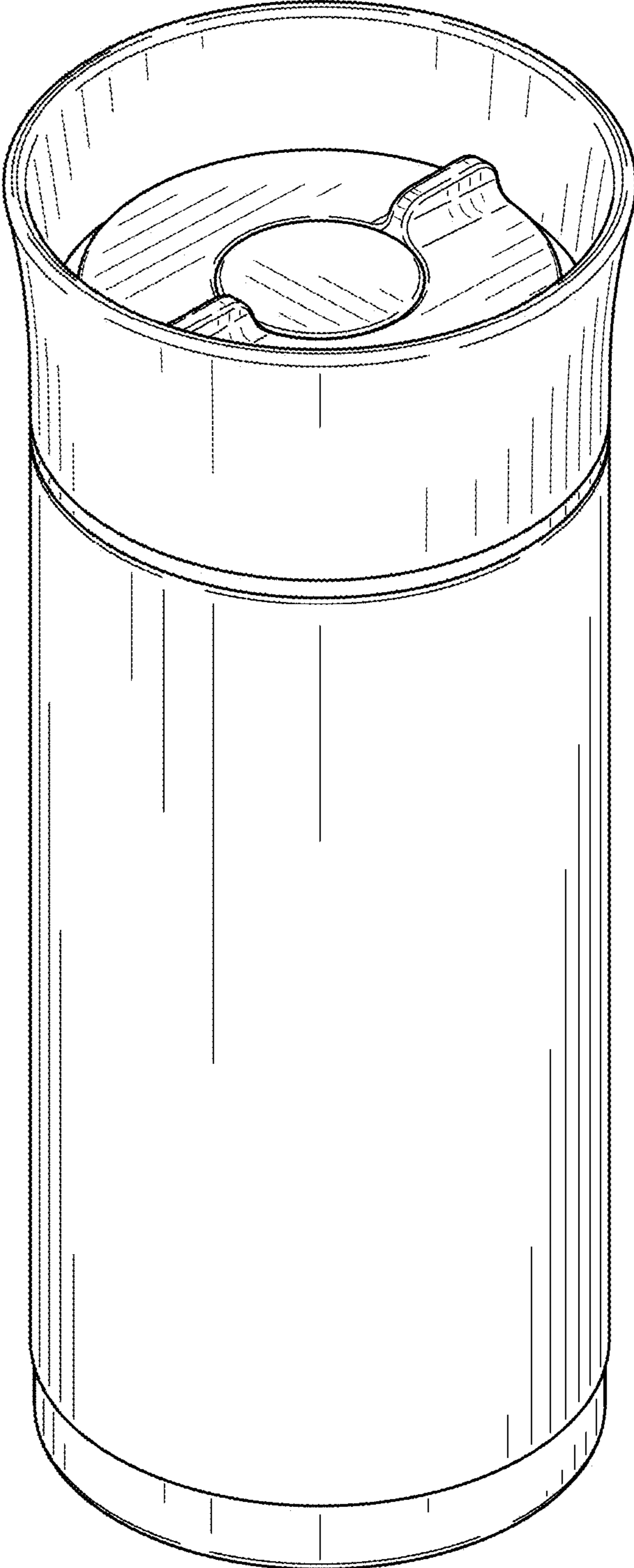

FIG. 1

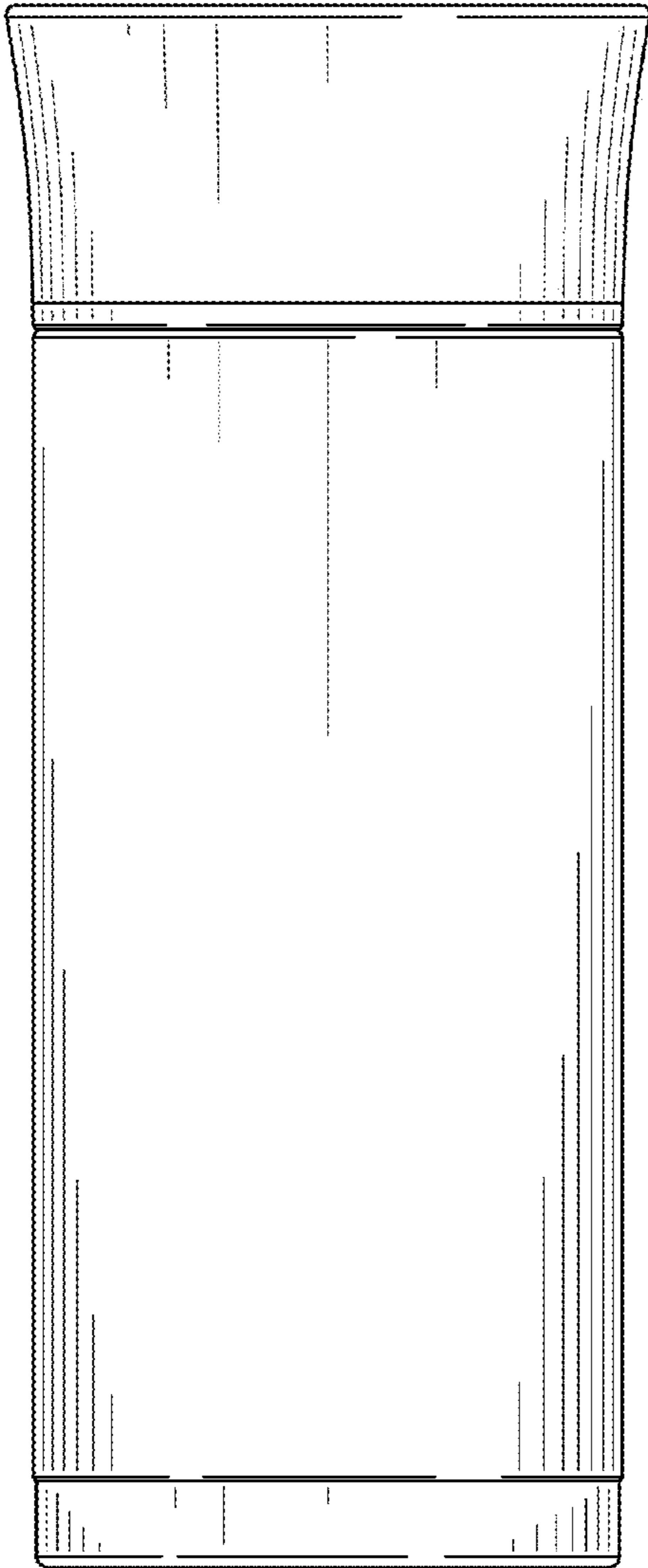

FIG. 2

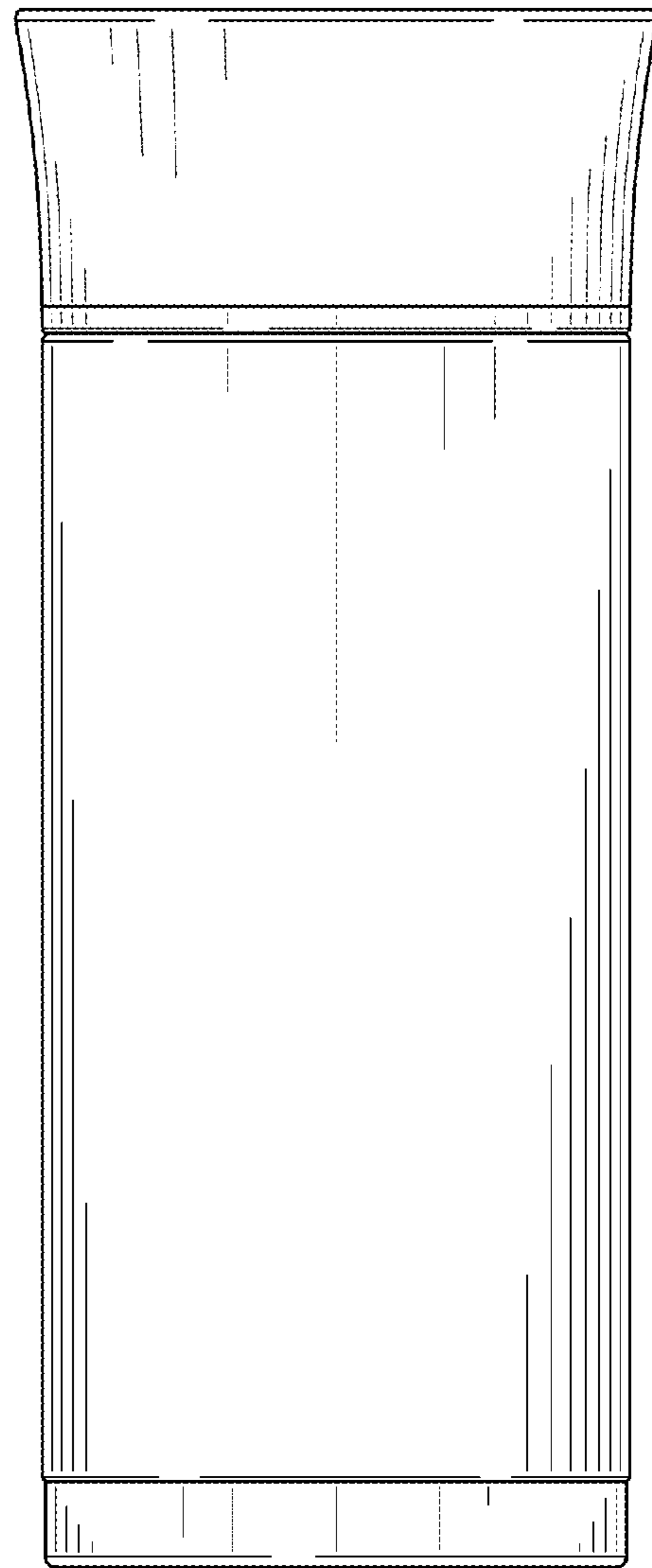

FIG. 3

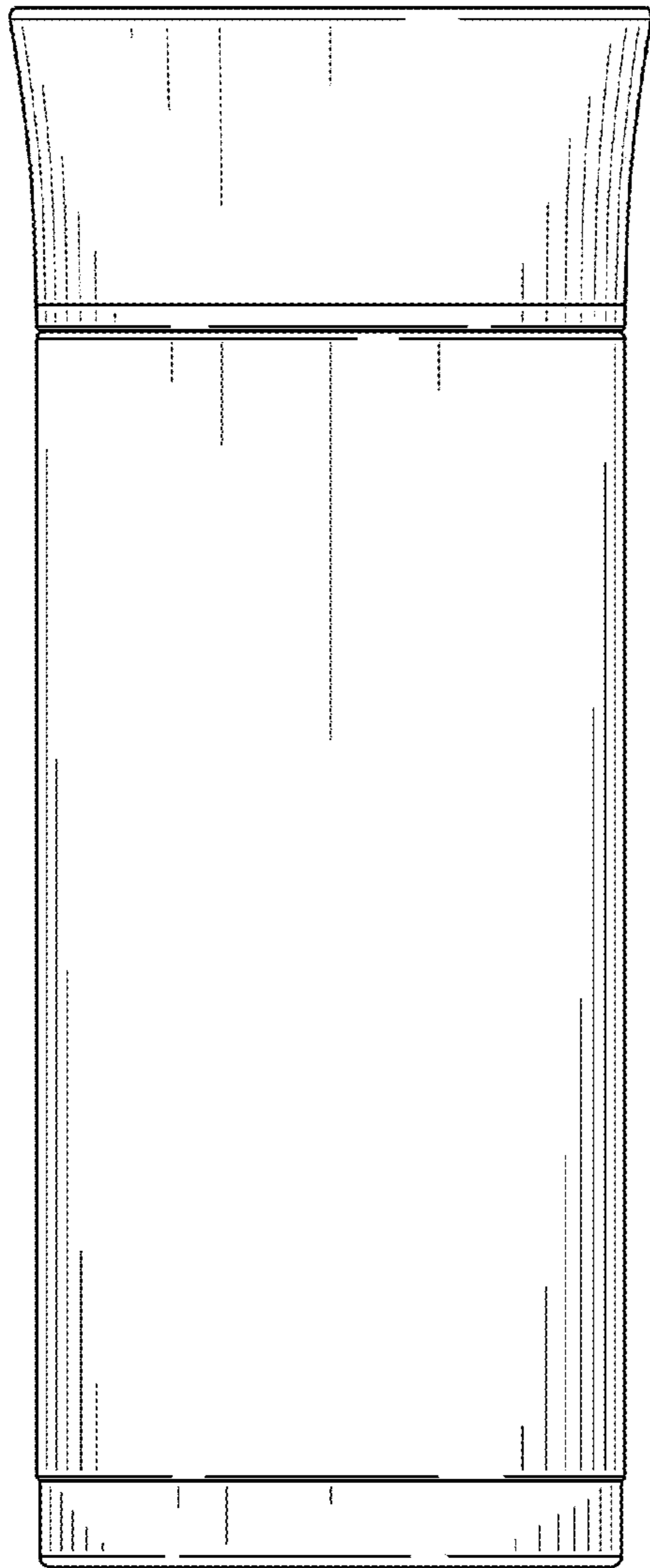

FIG. 4

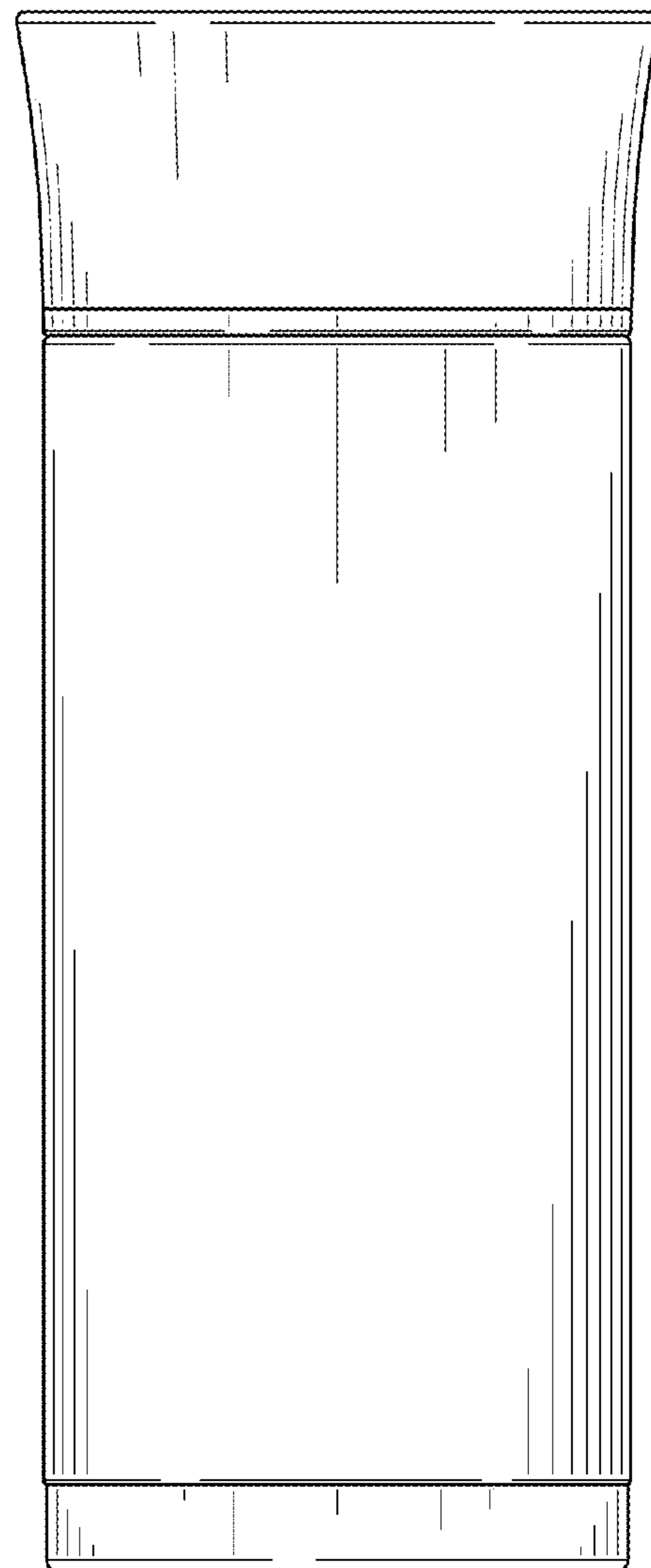

FIG. 5

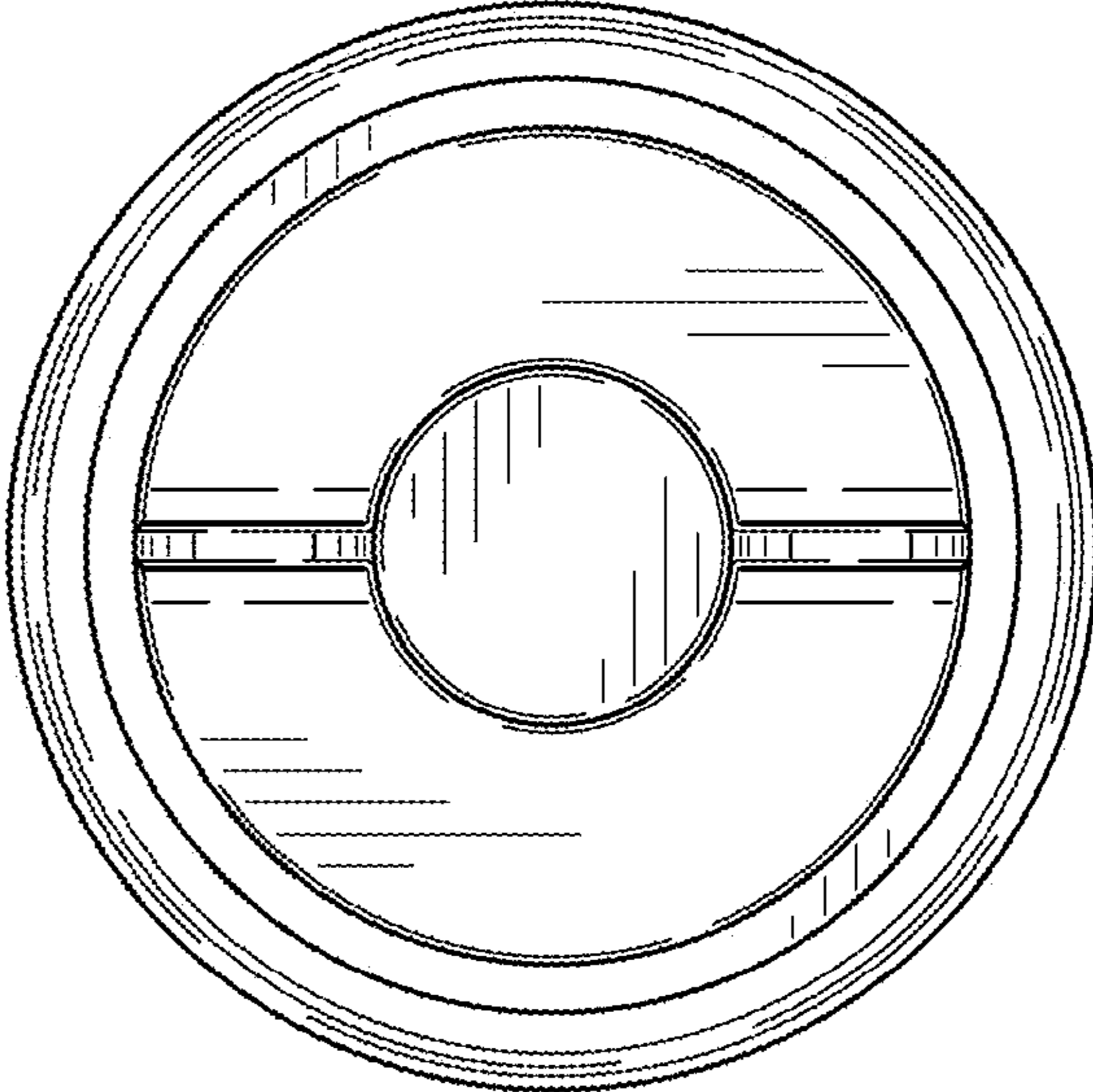

FIG. 6

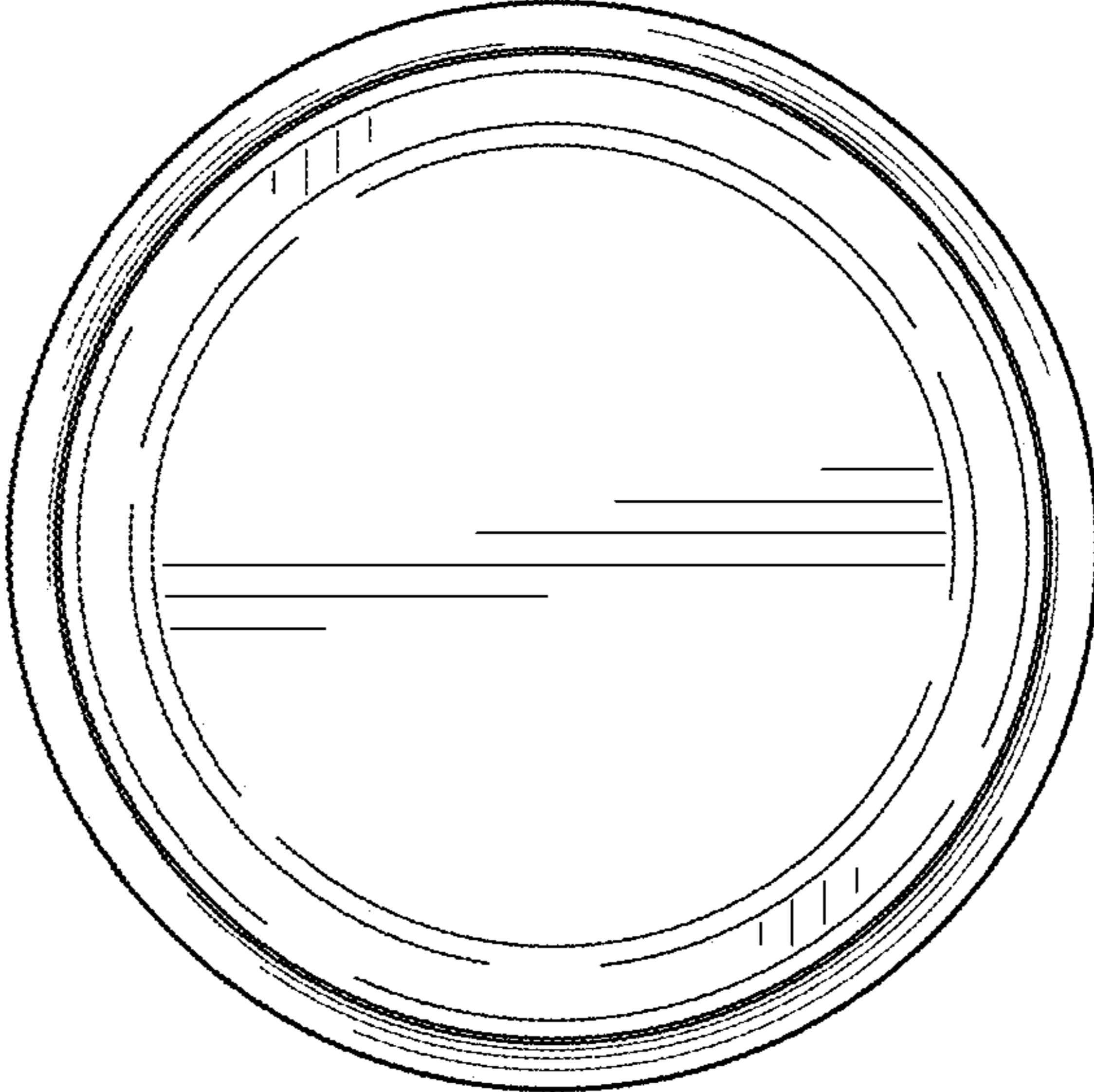

FIG. 7

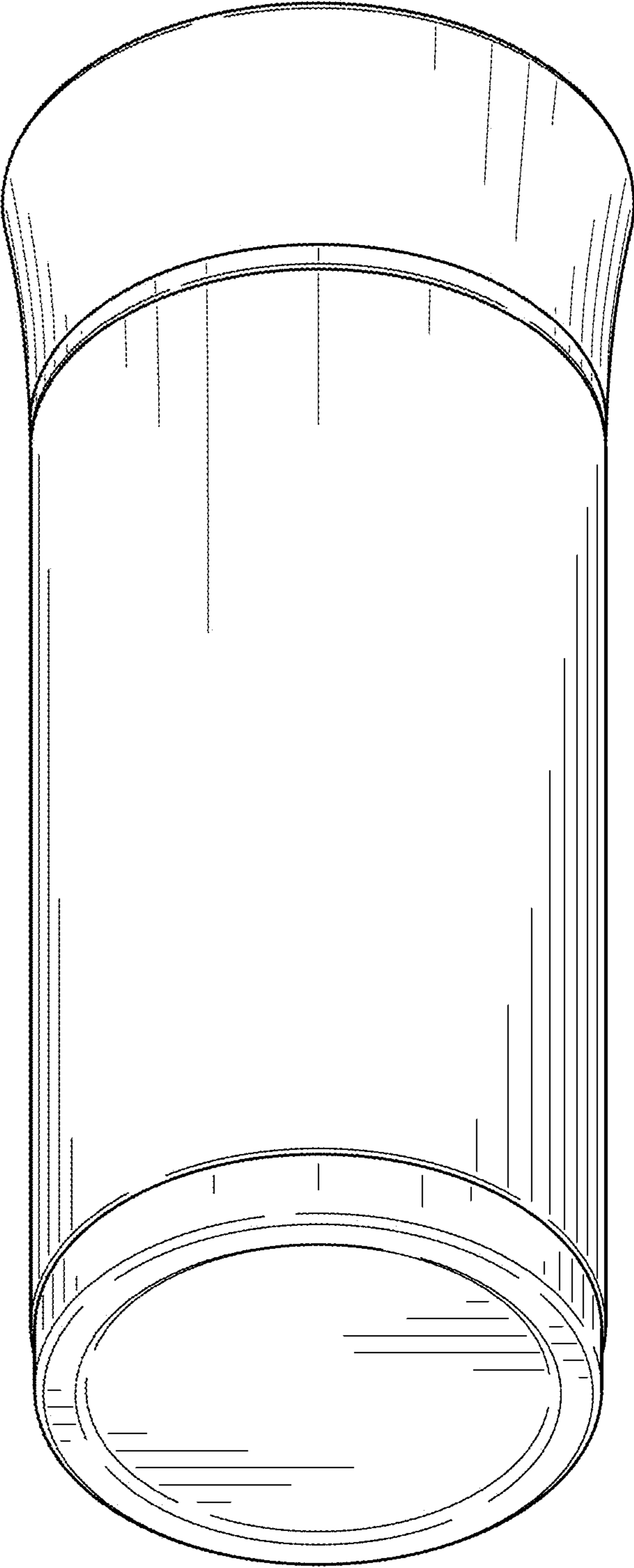

FIG. 8