



US00D760366S

(12) **United States Design Patent**  
**Cummings**

(10) **Patent No.:** **US D760,366 S**  
(45) **Date of Patent:** **\*\* Jun. 28, 2016**

- (54) **RIMLESS TOILET PAN**
- (71) Applicant: **Caroma Industries Limited**, Fortitude Valley (AU)
- (72) Inventor: **Stephen John Cummings**, Newport (AU)
- (73) Assignee: **Caroma Industries Limited**, Fortitude Valley, Queensland (AU)
- (\*\*) Term: **15 Years**
- (21) Appl. No.: **29/535,197**
- (22) Filed: **Aug. 4, 2015**
- (51) **LOC (10) Cl.** ..... **23-02**
- (52) **U.S. Cl.**  
USPC ..... **D23/300**
- (58) **Field of Classification Search**  
USPC ..... D23/295, 301, 303, 309, 313, 300  
CPC ..... E03D 1/00; E03D 1/01; E03D 1/012  
See application file for complete search history.

- D606,178 S 12/2009 Cummings et al.
- D606,179 S 12/2009 Cummings et al.
- D609,791 S 2/2010 Cummings et al.
- D683,437 S 5/2013 Newson
- D683,828 S 6/2013 Newson
- D703,797 S \* 4/2014 Shinozaki ..... D23/300
- D732,150 S \* 6/2015 Jung ..... D23/295

\* cited by examiner

*Primary Examiner* — Robert Delehanty  
(74) *Attorney, Agent, or Firm* — DASCENZO Intellectual Property Law, P.C.

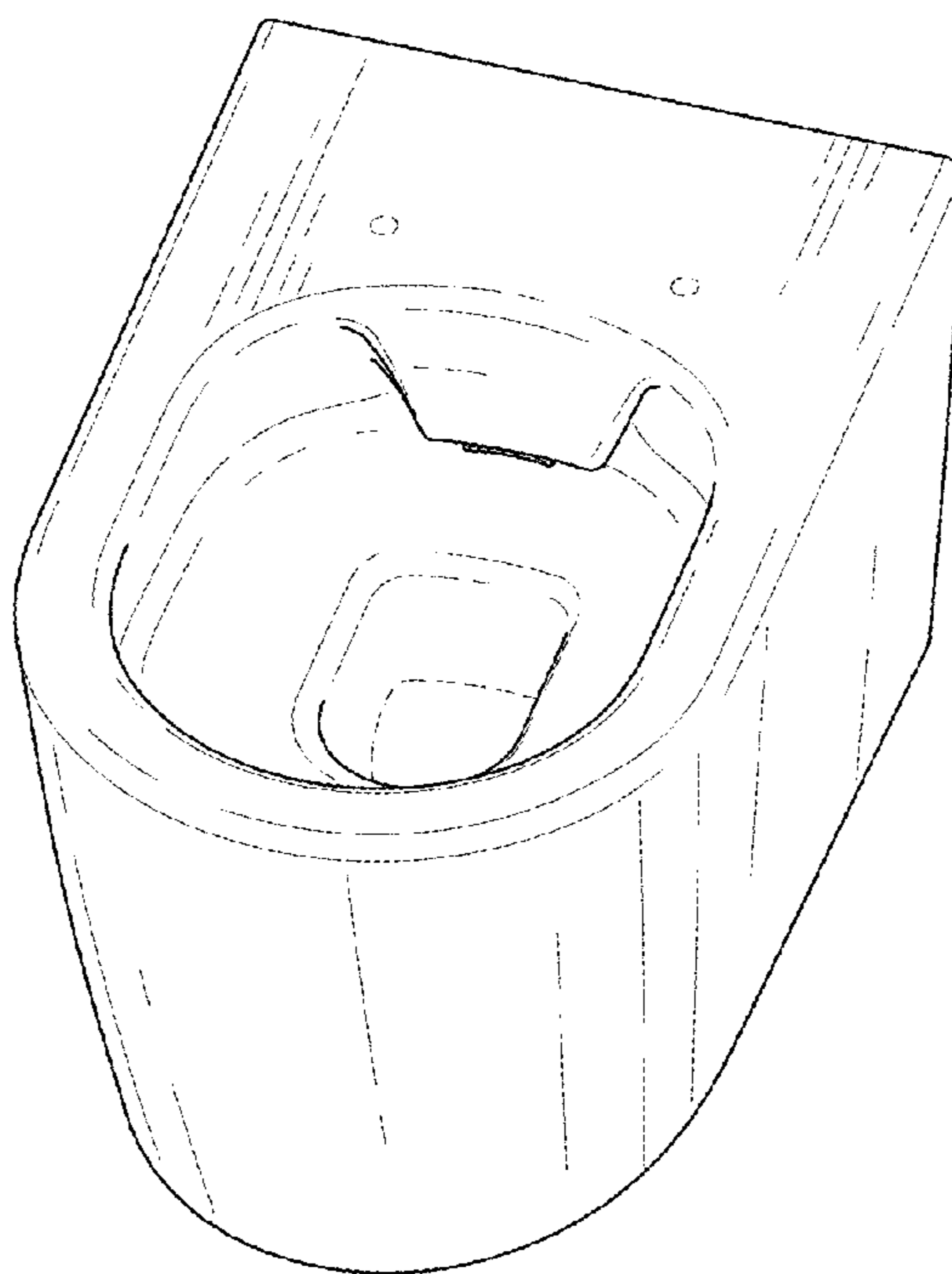
(57) **CLAIM**  
The ornamental design for a rimless toilet pan, as shown and described.

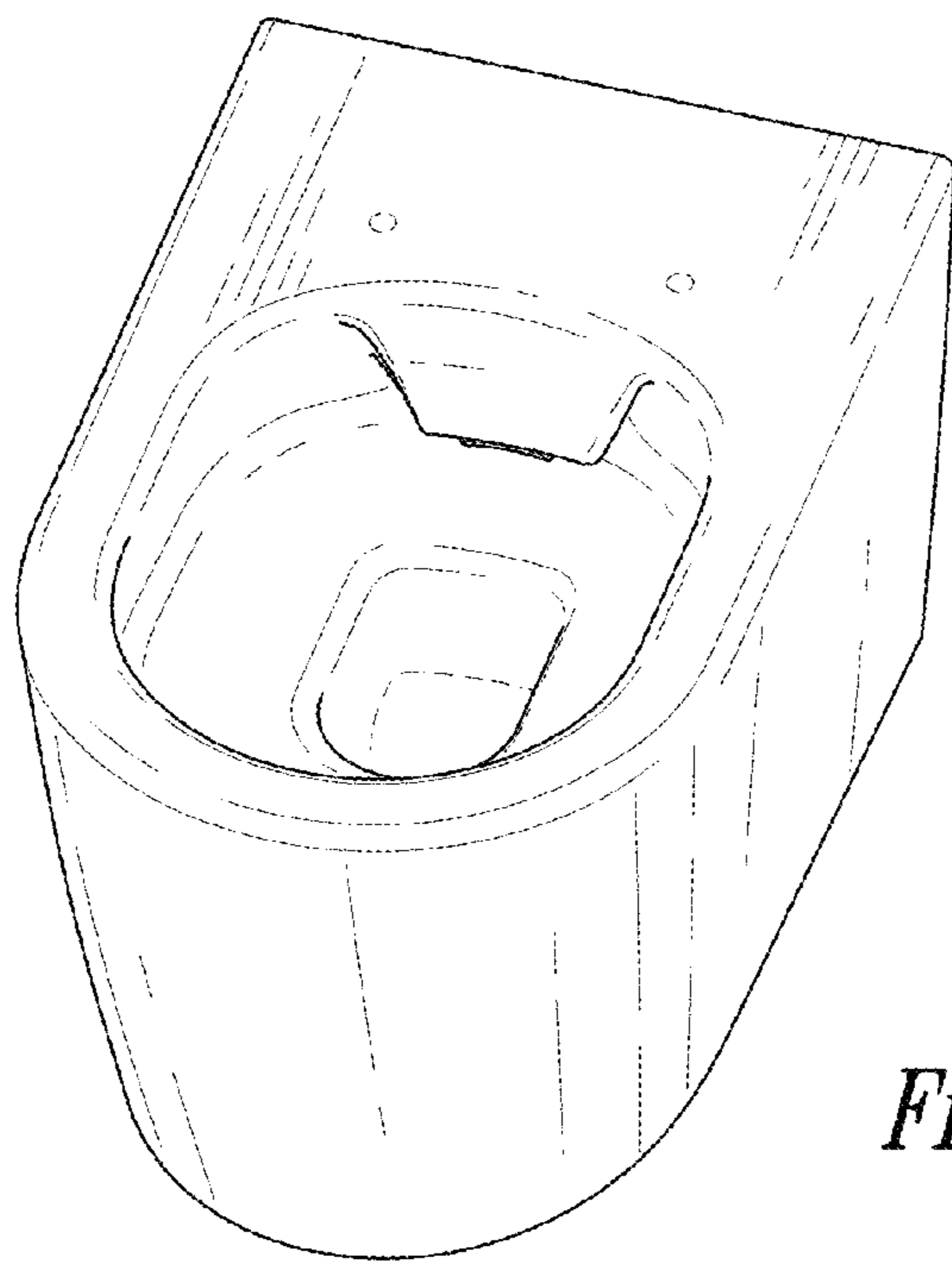
**DESCRIPTION**

FIG. 1 is a front isometric view of the new design.  
FIG. 2 is a rear isometric view of the new design.  
FIG. 3 is a top view of the new design.  
FIG. 4 is a bottom view of the new design.  
FIG. 5 is a right side view of the new design.  
FIG. 6 is a left side view of the new design.  
FIG. 7 is a front view of the new design; and,  
FIG. 8 is a rear view of the new design.  
The broken lines shown in the drawings illustrate portions of the toilet pan that form no part of the claimed design.

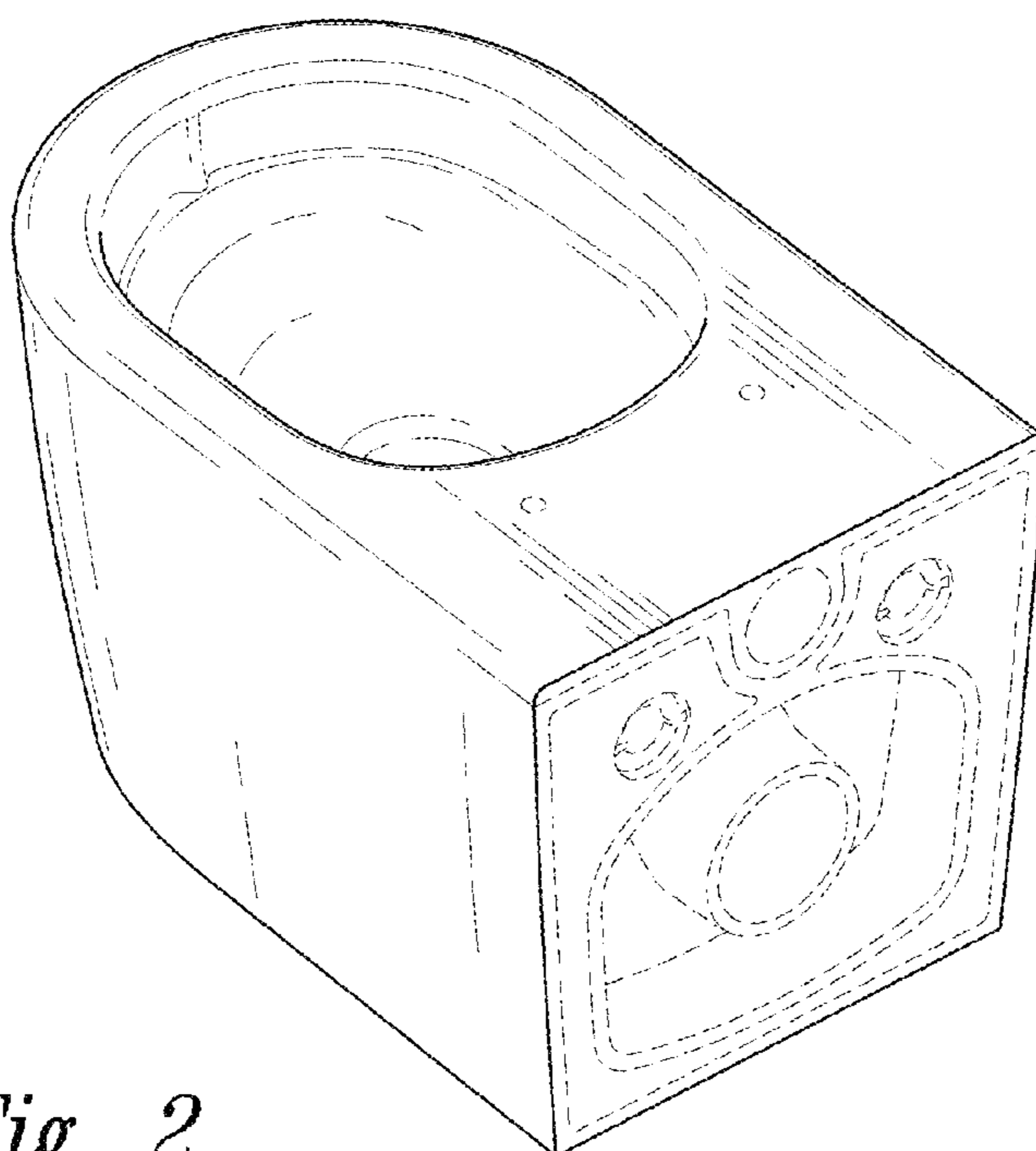
- (56) **References Cited**  
U.S. PATENT DOCUMENTS  
D586,893 S \* 2/2009 Cummings ..... D23/295  
D600,333 S \* 9/2009 Liu ..... D23/295

**1 Claim, 4 Drawing Sheets**

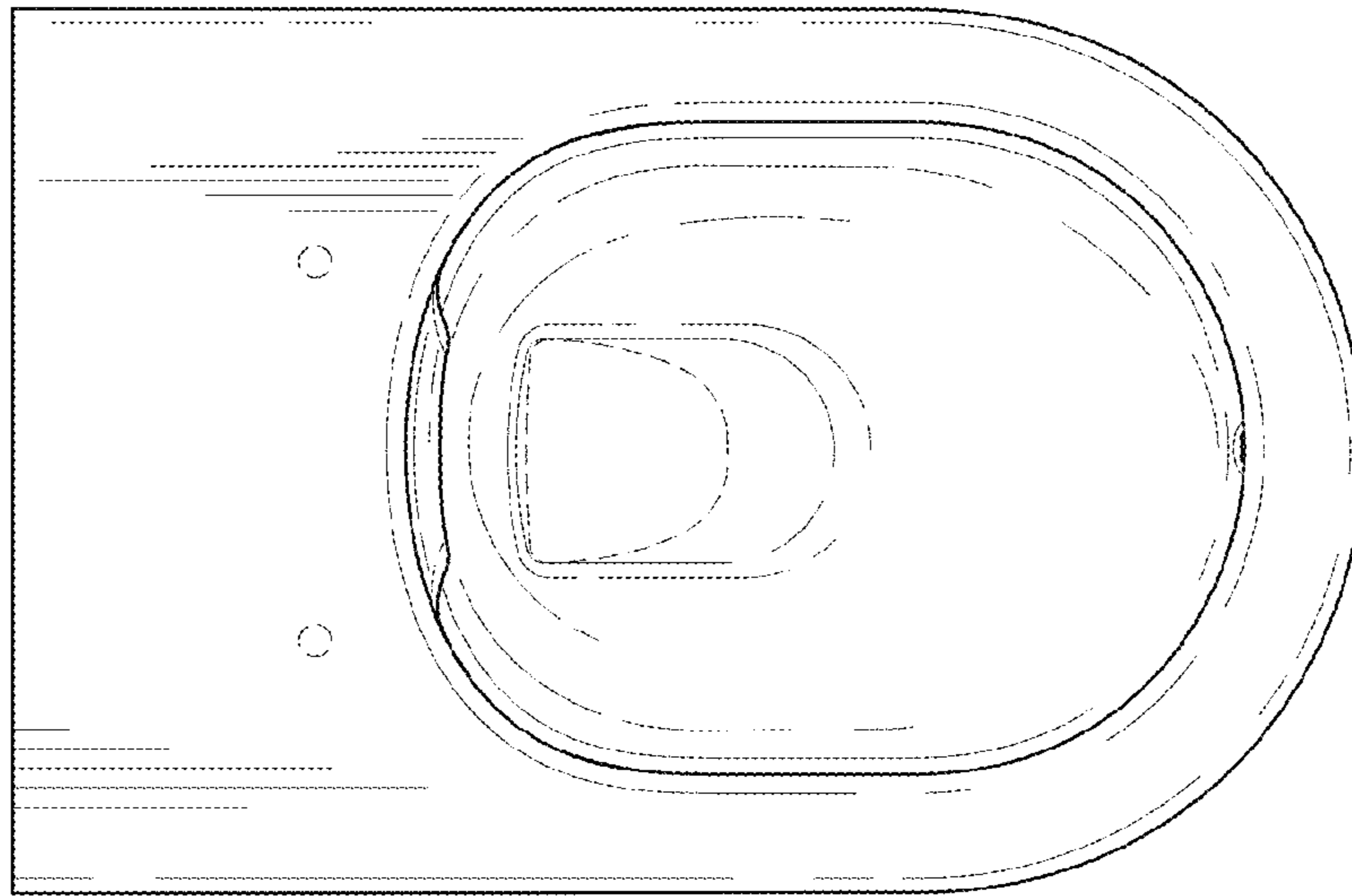




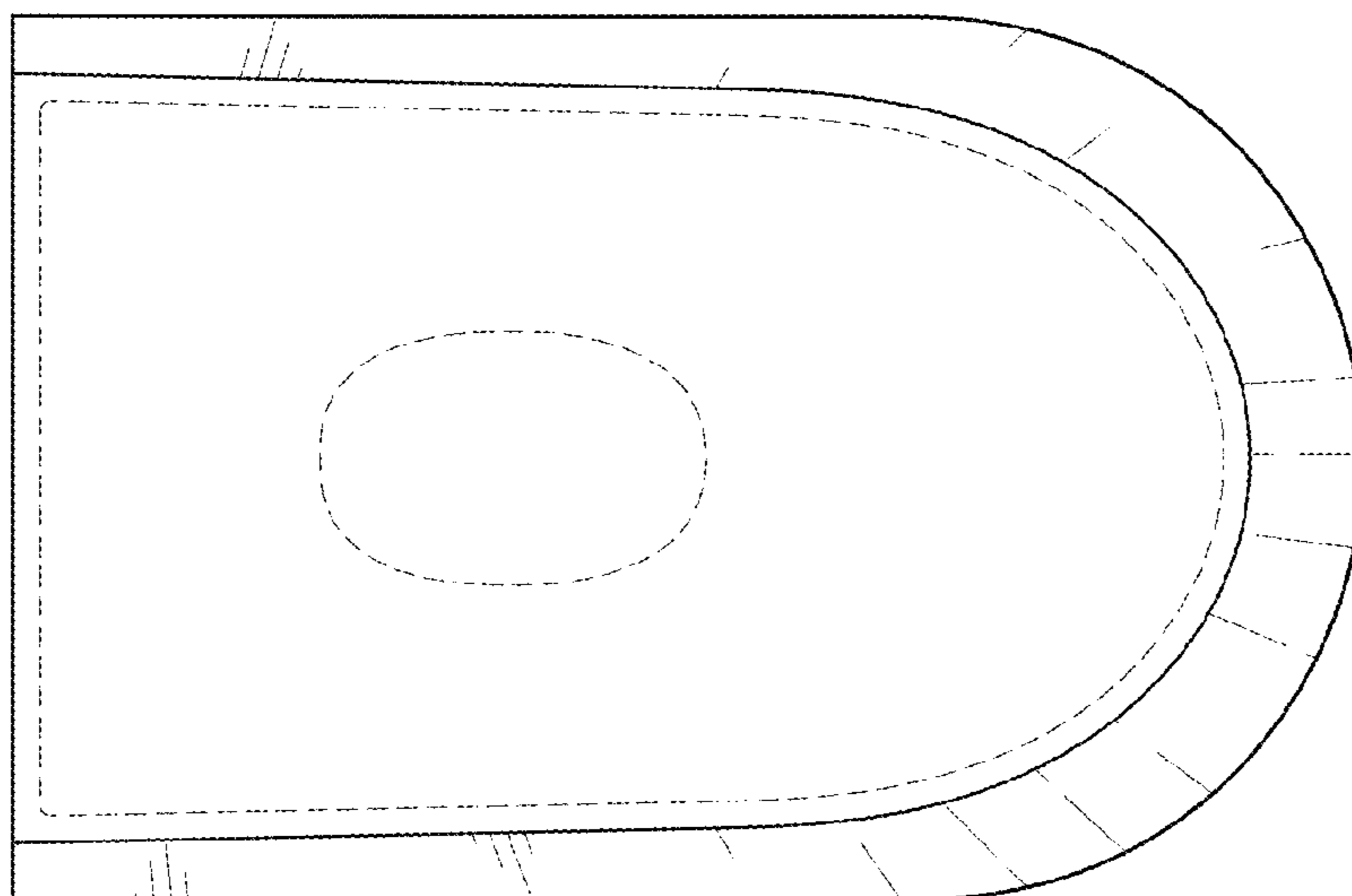
*Fig. 1*



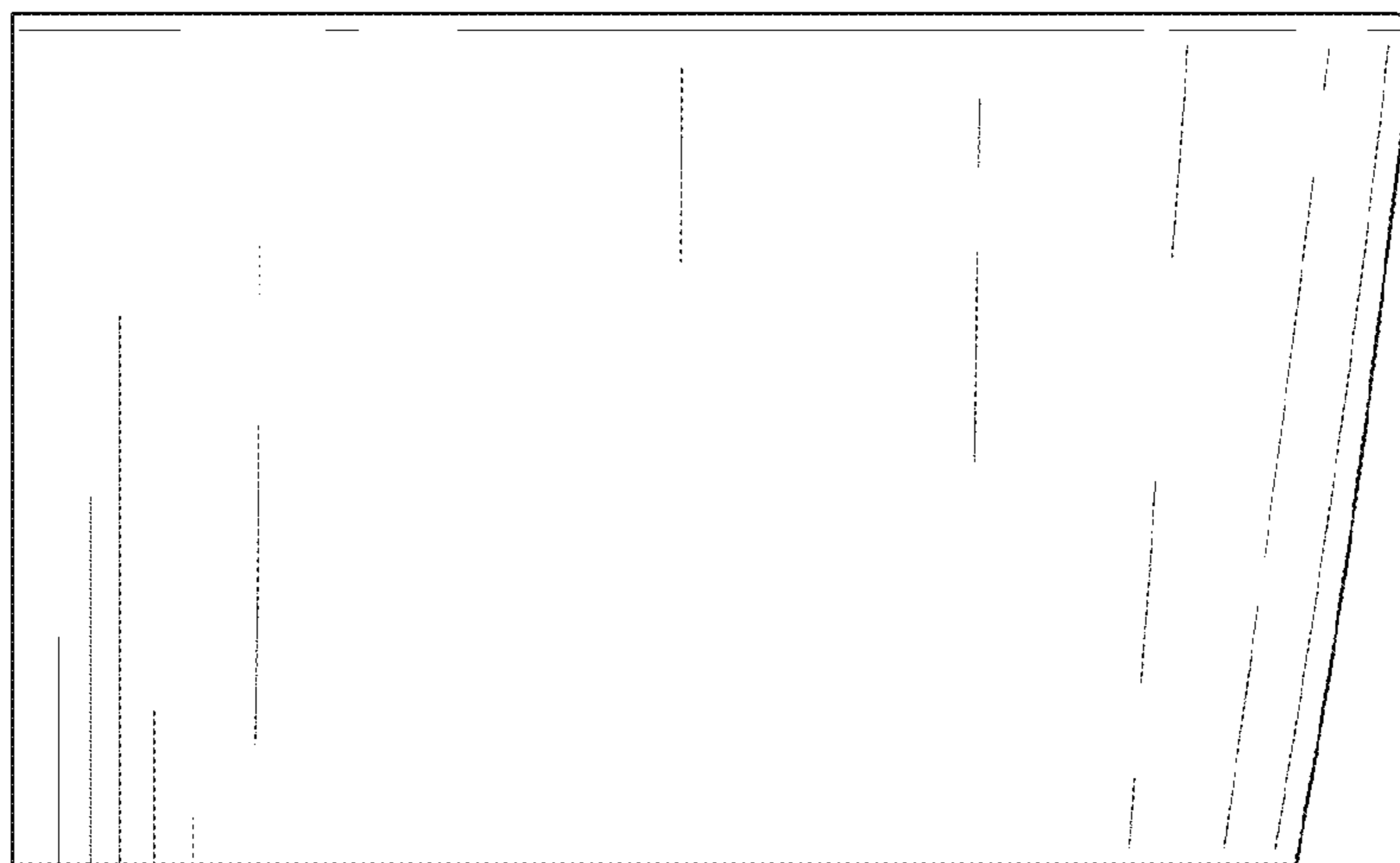
*Fig. 2*



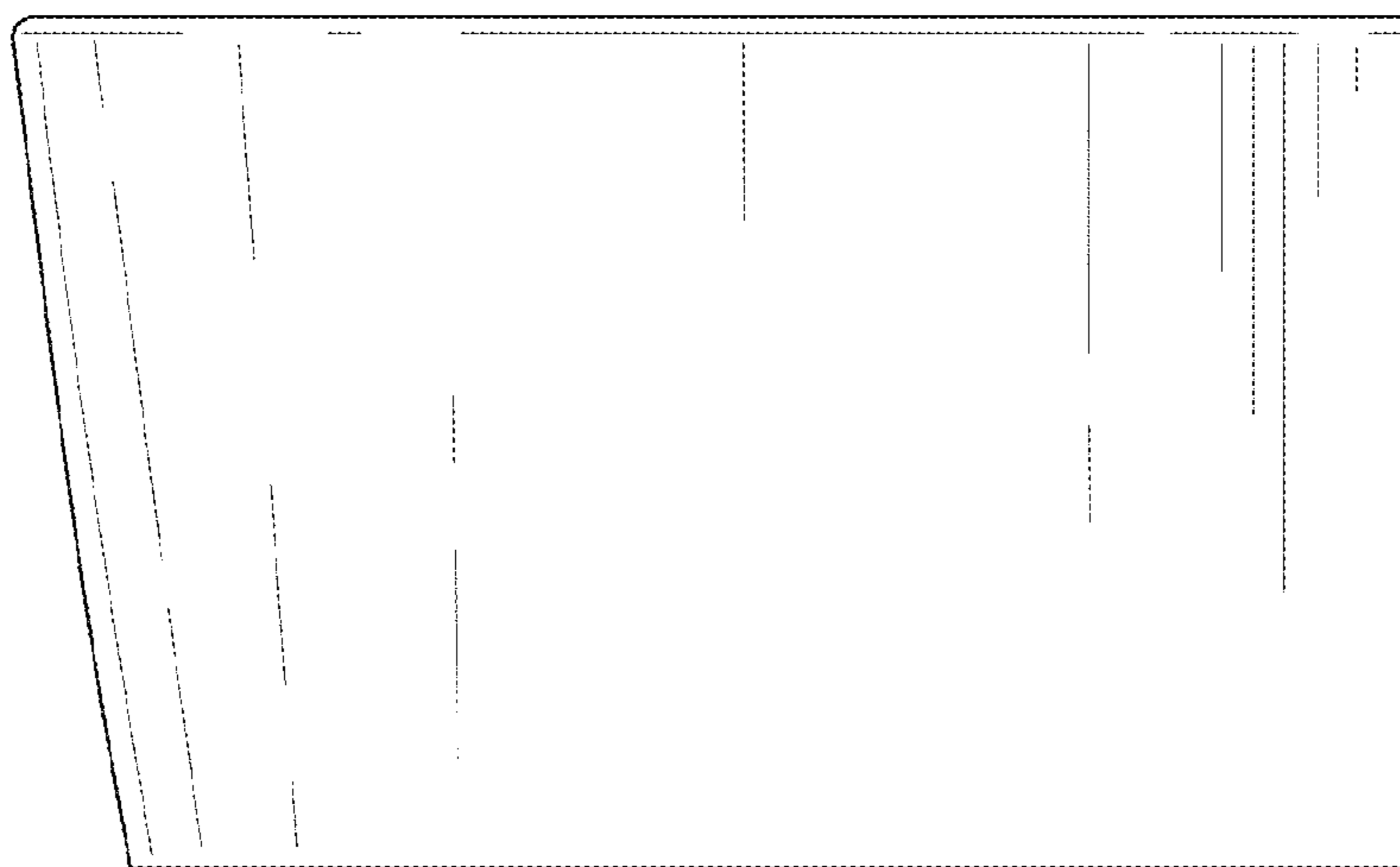
*Fig. 3*



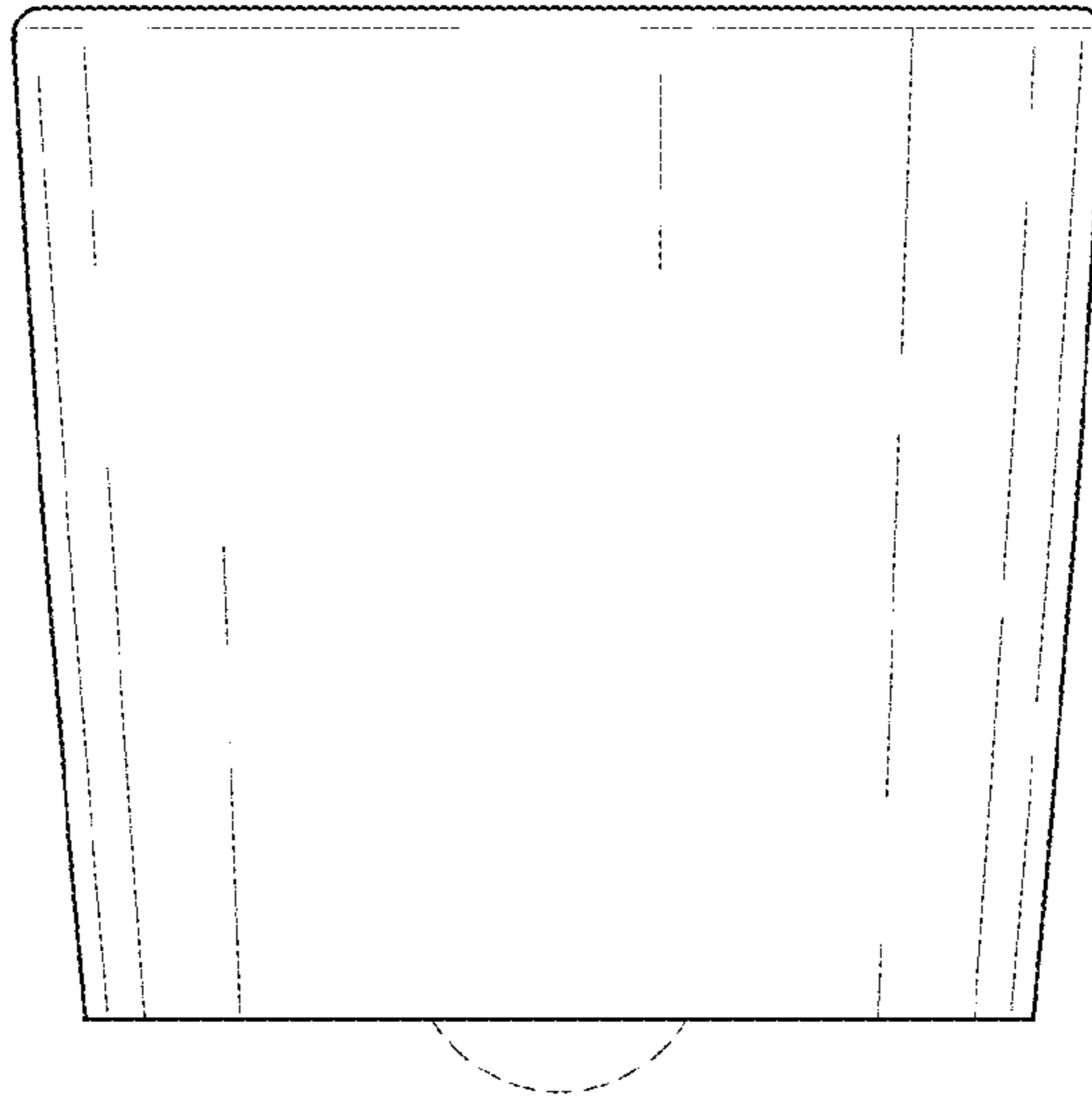
*Fig. 4*



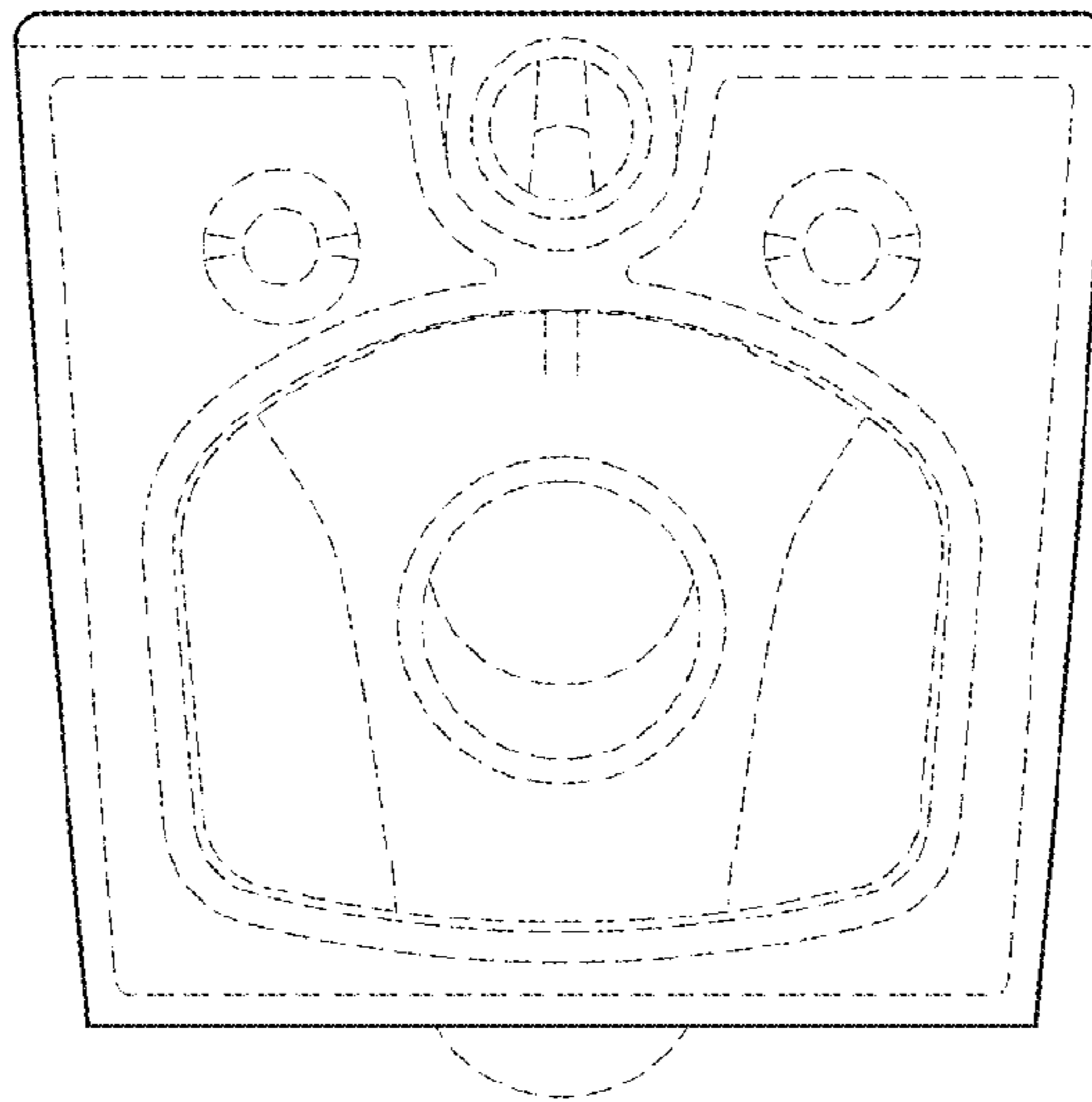
*Fig. 5*



*Fig. 6*



*Fig. 7*



*Fig. 8*