



US00D760348S

(12) **United States Design Patent**
McCutcheon et al.

(10) **Patent No.:** **US D760,348 S**
(45) **Date of Patent:** **** Jun. 28, 2016**

(54) **SHOWER HEAD**

(71) Applicant: **Methven Limited**, Auckland (NZ)

(72) Inventors: **Stephen McLay McCutcheon**,
Auckland (NZ); **Scott Douglas**
Fitzsimons, Auckland (NZ); **Kent**
Bradley Thomas Sneddon, Auckland
(NZ)

(73) Assignee: **Methven Limited**, Auckland (NZ)

(**) Term: **14 Years**

(21) Appl. No.: **29/524,649**

(22) Filed: **Apr. 22, 2015**

(30) **Foreign Application Priority Data**

Oct. 22, 2014 (NZ) 419479

(51) **LOC (10) Cl.** **23-01**

(52) **U.S. Cl.**
USPC **D23/213**

(58) **Field of Classification Search**
USPC D23/213, 223, 229, 230; 239/282, 283;
4/615
CPC B05B 1/18; B05B 1/00
See application file for complete search history.

(56) **References Cited**

U.S. PATENT DOCUMENTS

D313,267 S * 12/1990 Lenci D23/213
D326,311 S * 5/1992 Lenci D23/213
D346,430 S * 4/1994 Warshawsky D23/213

D580,010 S * 11/2008 Lee D23/213
D608,412 S * 1/2010 Barnard D23/223
D668,320 S * 10/2012 Weihreter D23/213
D674,046 S * 1/2013 Berger D23/223
D713,003 S * 9/2014 Sandee D23/223
D733,258 S * 6/2015 Sandee D23/223
D737,930 S * 9/2015 Rexach D23/223
D737,932 S * 9/2015 Nikles D23/223

FOREIGN PATENT DOCUMENTS

CN 101954318 A 1/2011
CN 201760354 U 3/2011
CN 102059181 A 5/2011
CN 203750724 U 8/2014
CN 204051956 U 12/2014
JP 2002238793 A 8/2002

* cited by examiner

Primary Examiner — Robin V Webster

(74) *Attorney, Agent, or Firm* — Lowe Graham Jones PLLC

(57) **CLAIM**

We claim the ornamental design for the shower head, as shown and described.

DESCRIPTION

FIG. 1 is top view of a shower head, showing our new design. FIG. 2 is a front view of the shower head. FIG. 3 is a right side view of the shower head. FIG. 4 is a rear view of the shower head. FIG. 5 is a left side view of the shower head. FIG. 6 is a bottom view of the shower head. FIG. 7 is a front perspective view of the shower head; and, FIG. 8 is a rear perspective view of the shower head. The features shown in broken lines are for illustrative purposes only and form no part of the claimed design.

1 Claim, 3 Drawing Sheets

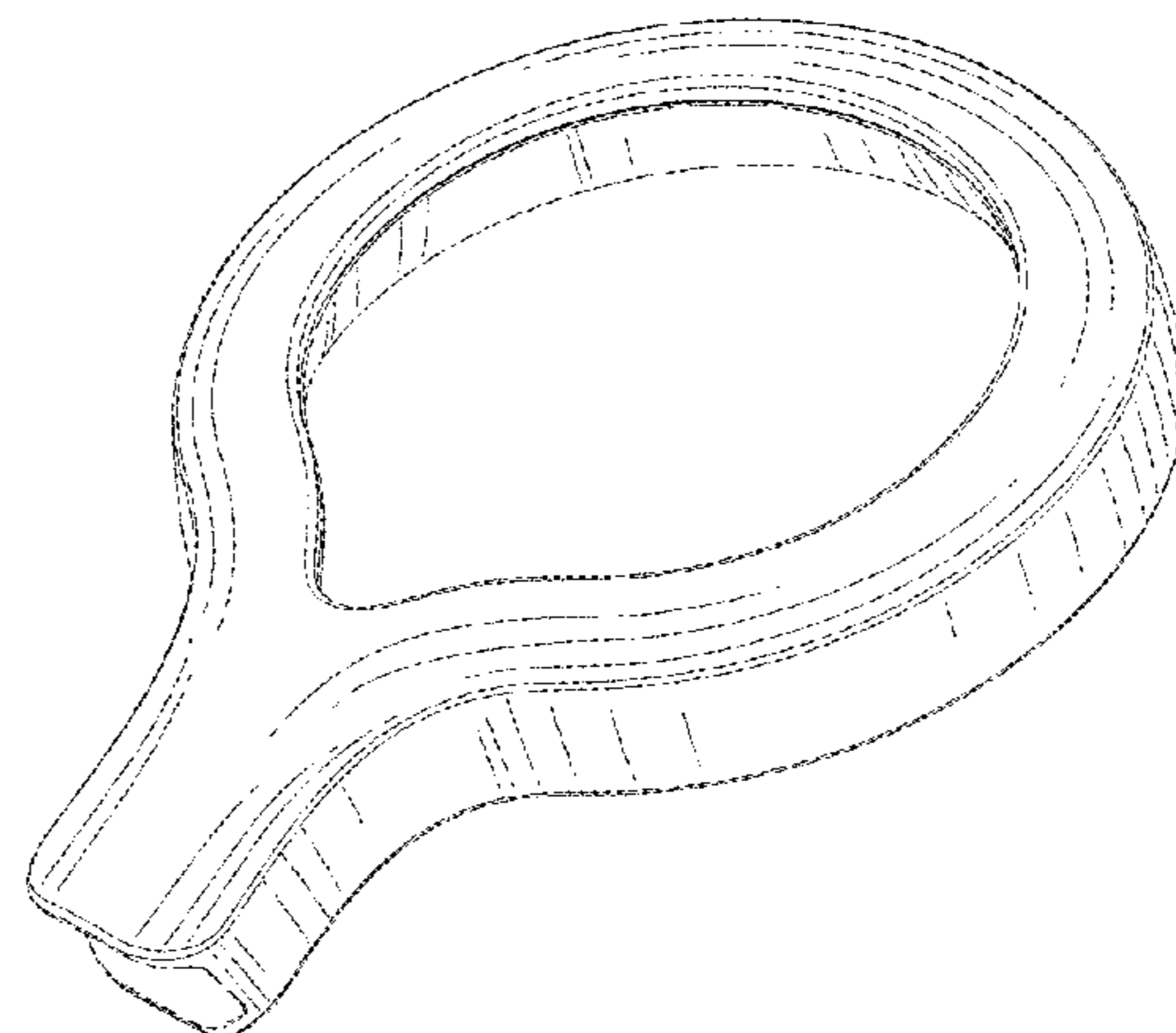
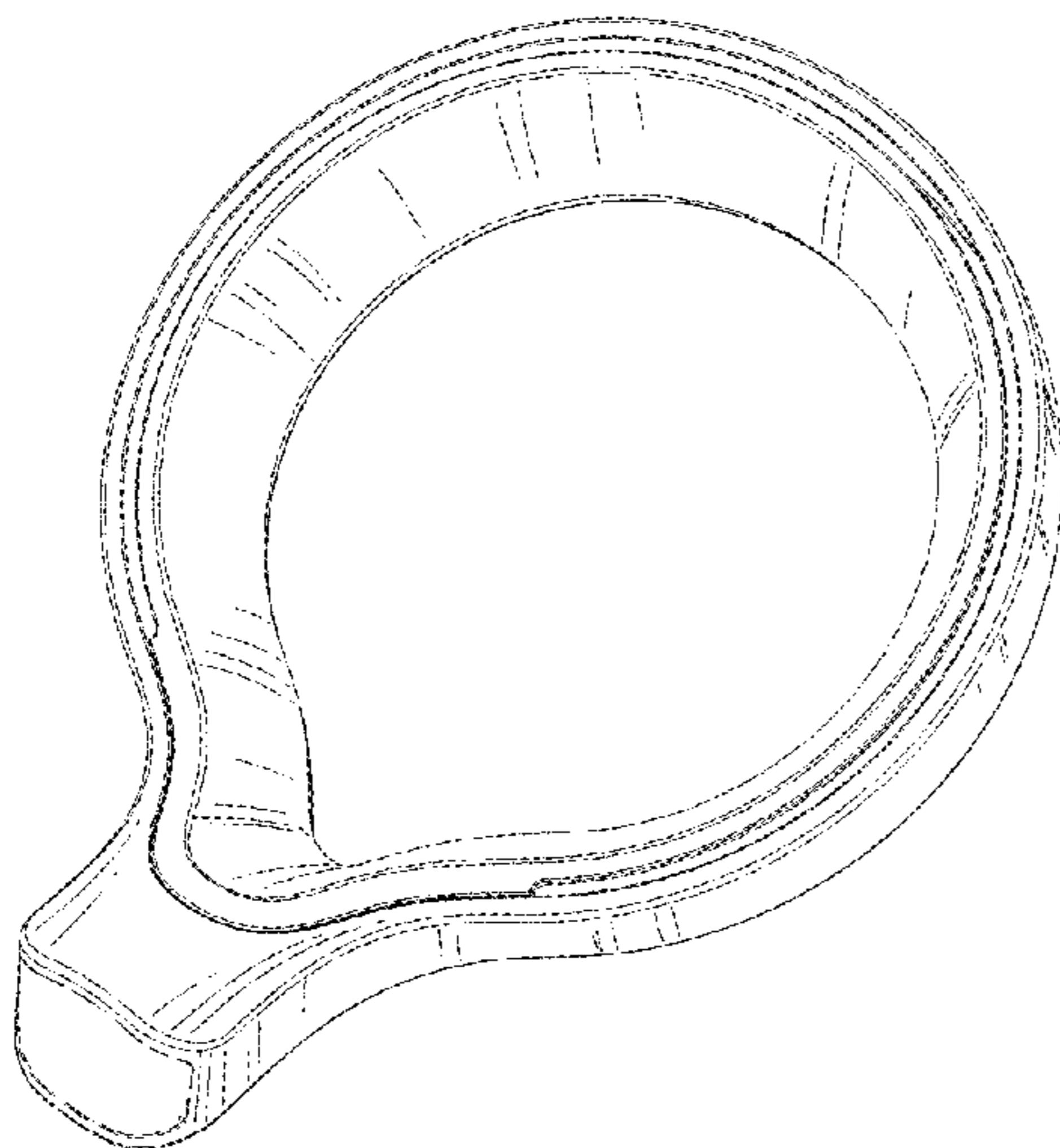

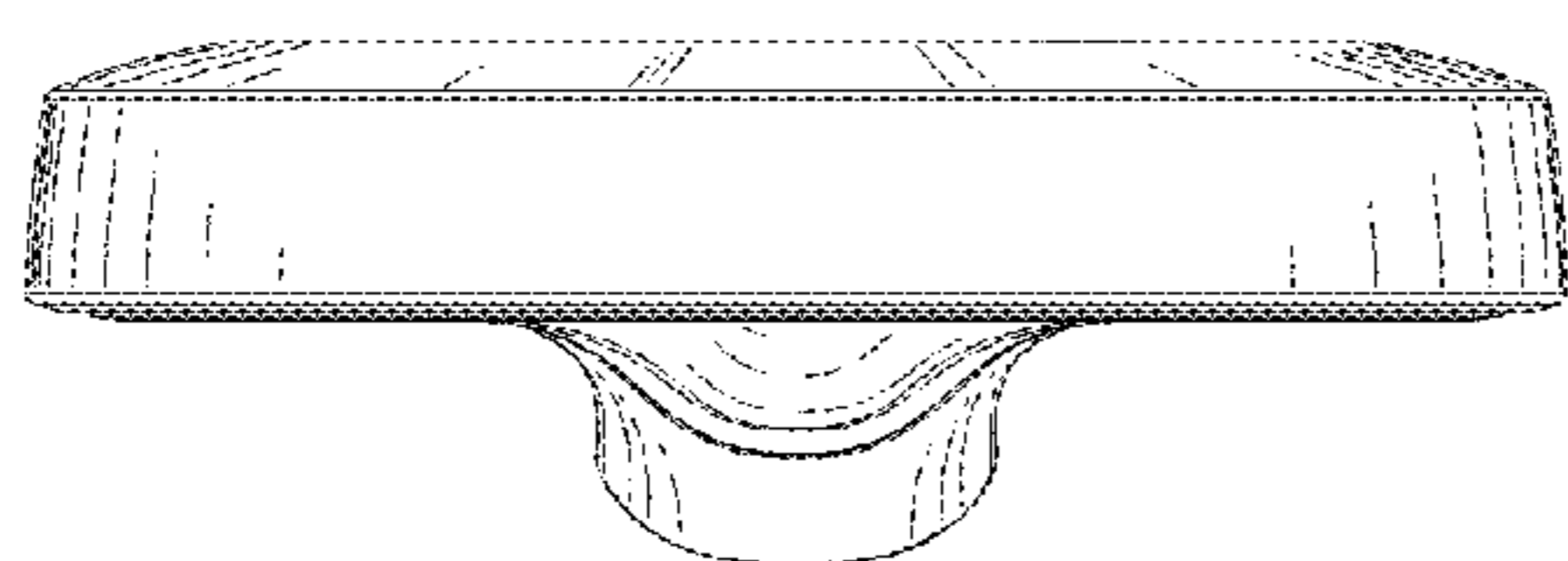

Figure 1

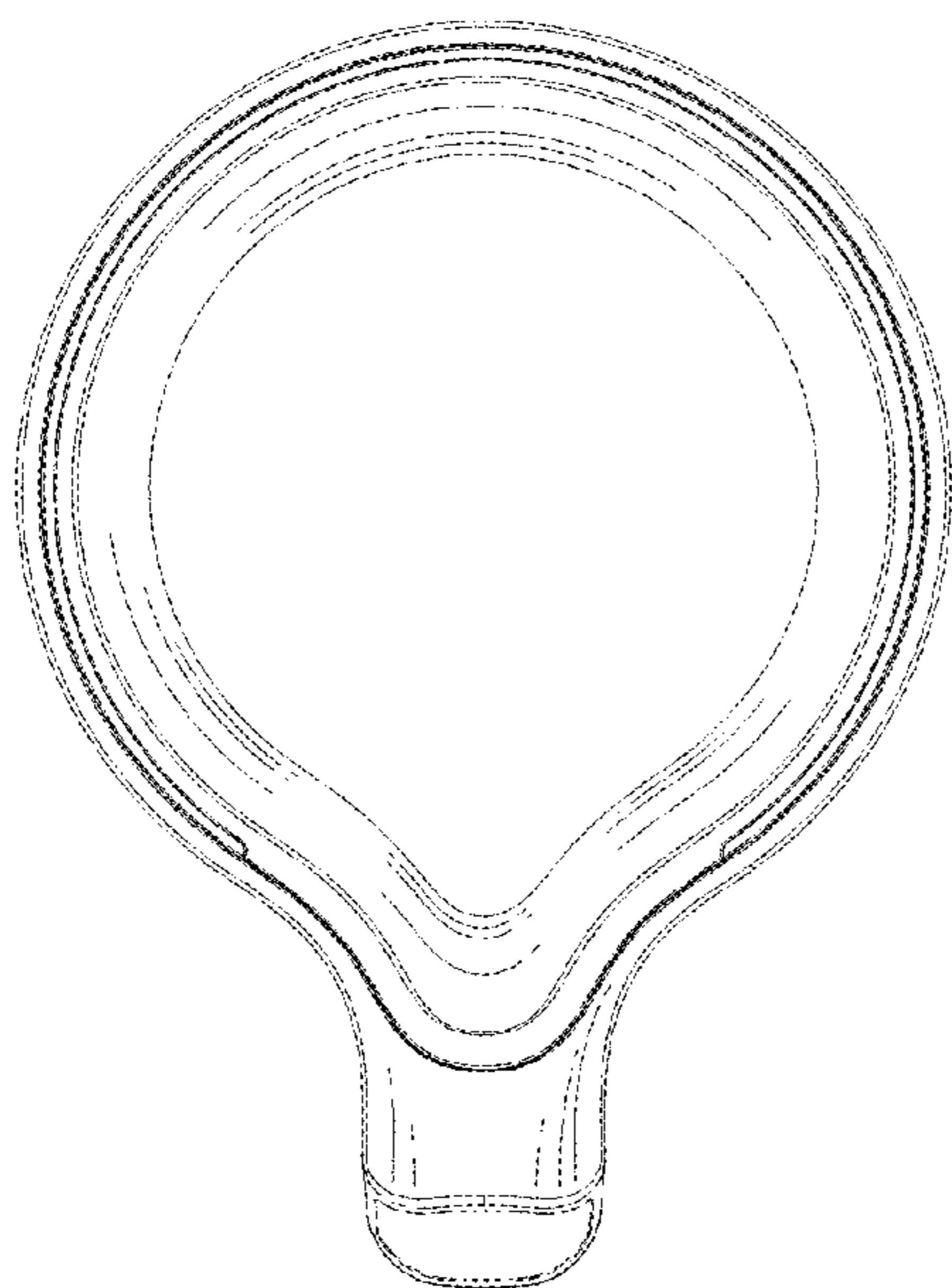

Figure 2

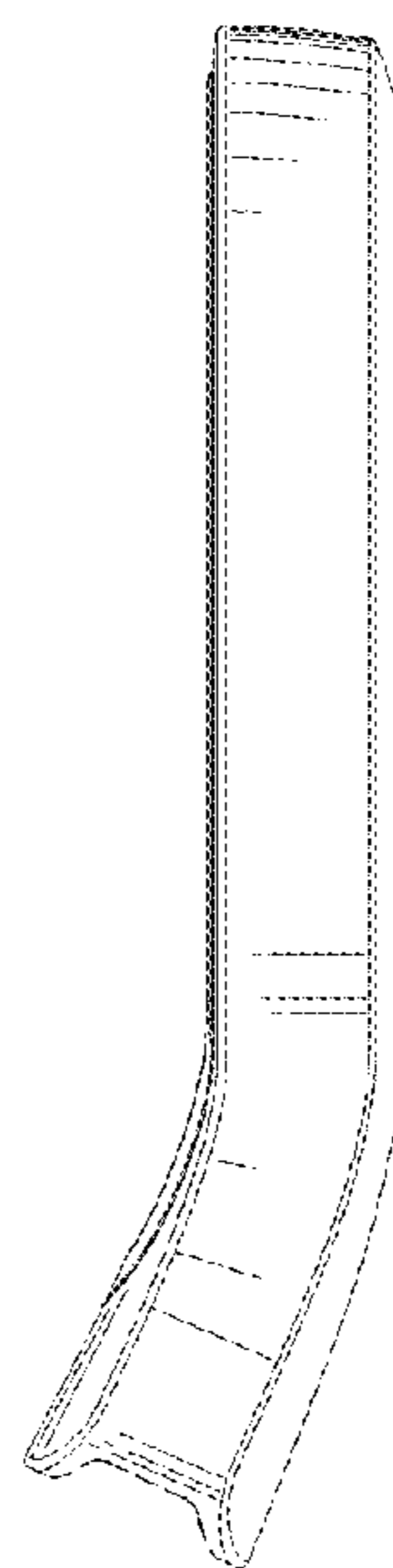

Figure 3

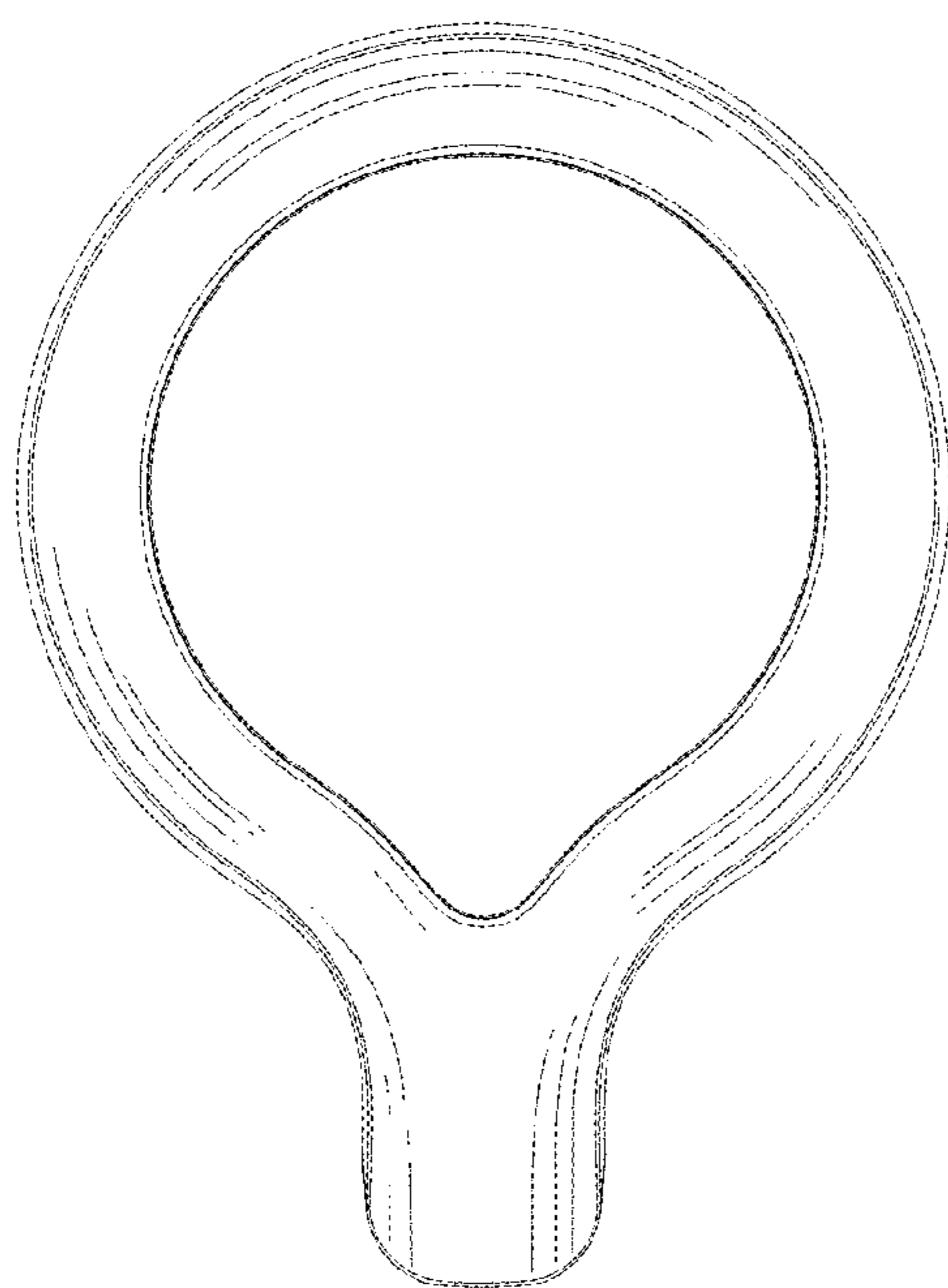

Figure 4

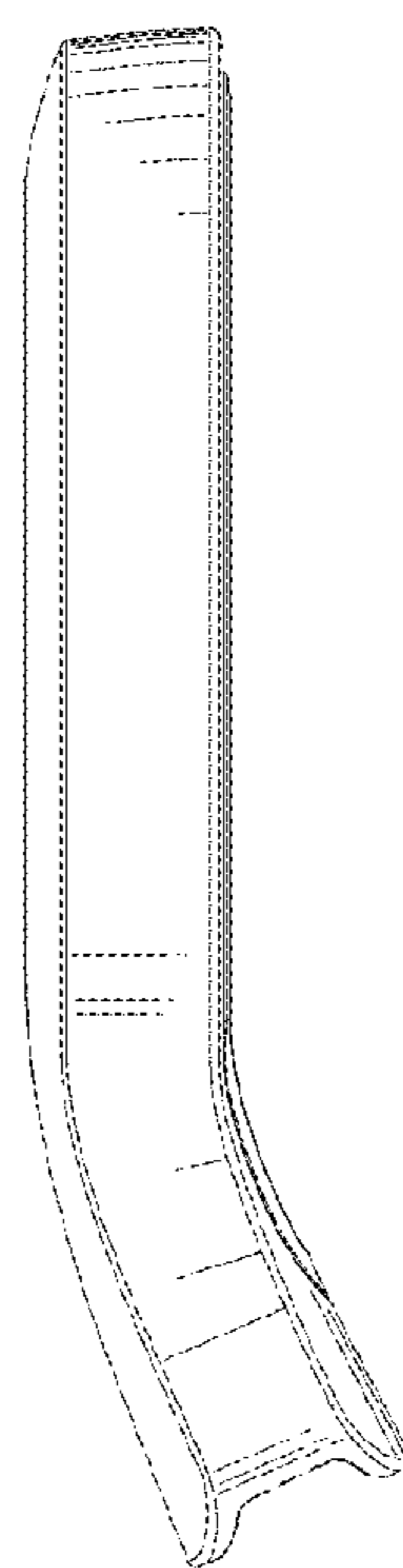

Figure 5

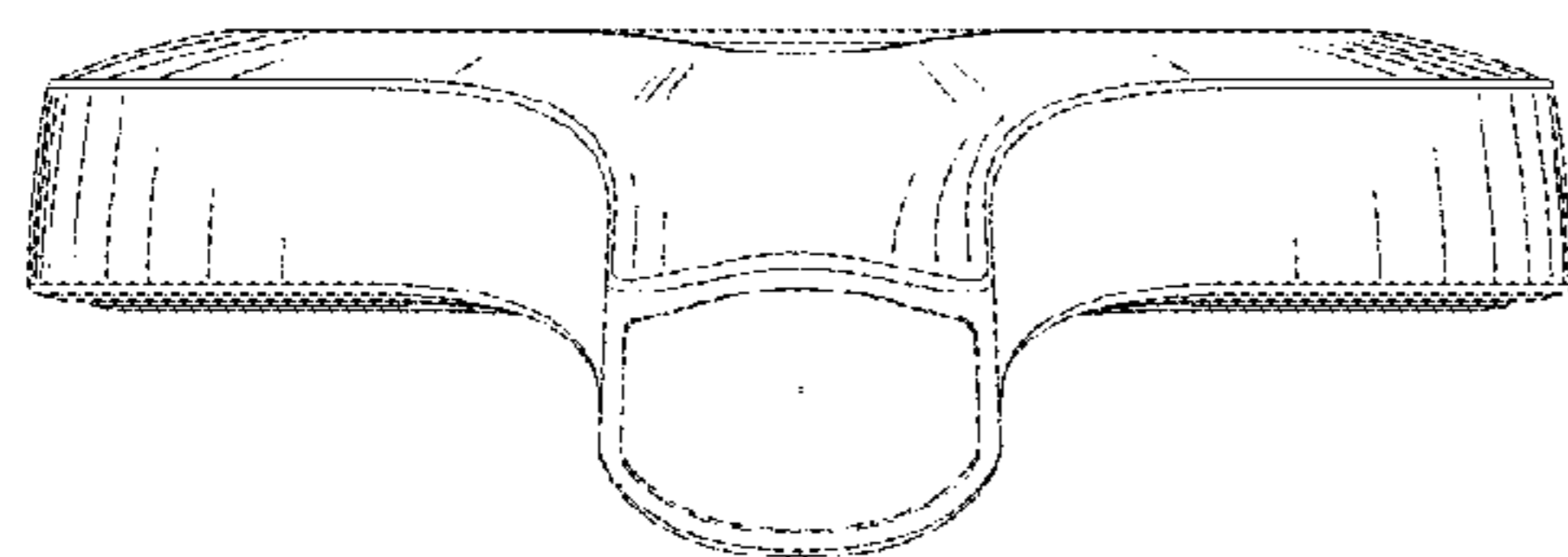

Figure 6

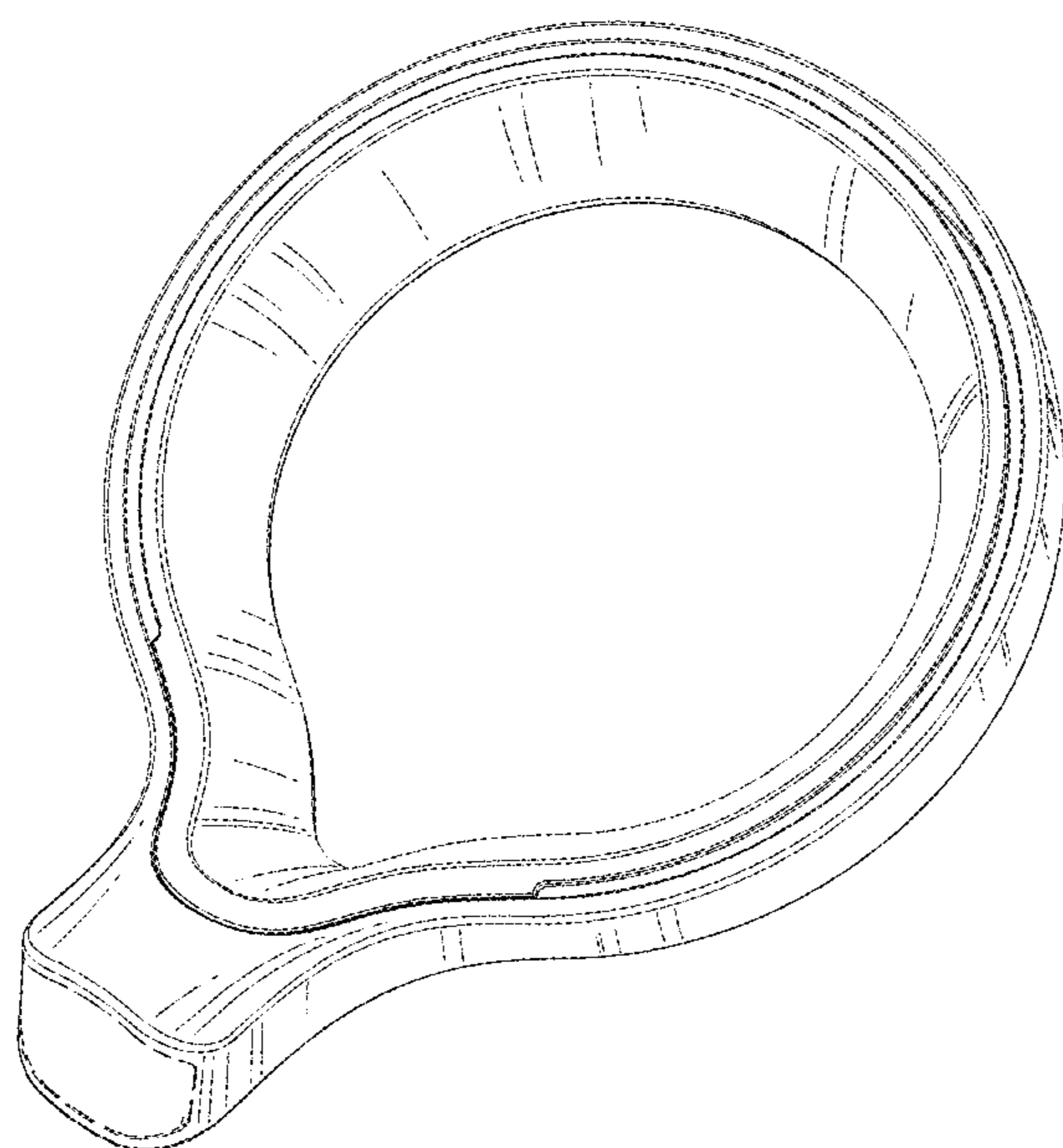

Figure 7

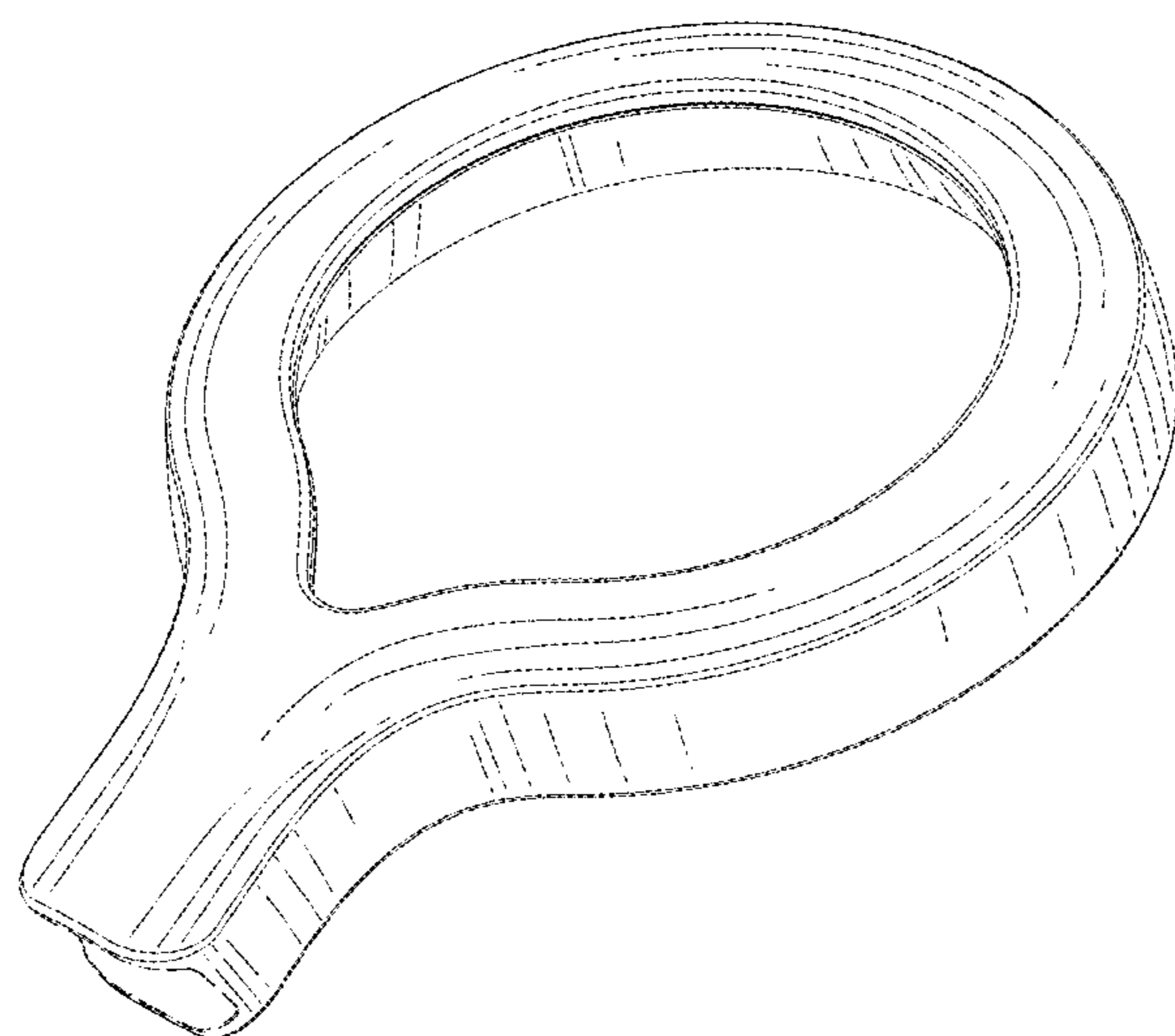

Figure 8