



US00D760339S

(12) **United States Design Patent**  
**Yao**

(10) **Patent No.:** **US D760,339 S**  
(45) **Date of Patent:** **\*\* Jun. 28, 2016**

- (54) **GUN MAGAZINE RELEASING APPARATUS**
- (71) Applicant: **Po Jen Yao**, West Covina, CA (US)
- (72) Inventor: **Po Jen Yao**, West Covina, CA (US)
- (\*\*) Term: **14 Years**
- (21) Appl. No.: **29/515,436**
- (22) Filed: **Jan. 22, 2015**
- (51) **LOC (10) Cl.** ..... **22-01**
- (52) **U.S. Cl.**  
USPC ..... **D22/108**
- (58) **Field of Classification Search**  
USPC ..... D22/103, 108  
CPC ..... F41A 17/38; F41A 3/72; F41A 9/59  
See application file for complete search history.

8,713,832 B2 \* 5/2014 Troy ..... F41A 17/38  
42/6  
D717,905 S \* 11/2014 Prince ..... D22/108  
9,182,186 B1 \* 11/2015 Prince ..... F41A 17/38  
2006/0123683 A1 \* 6/2006 Garrett ..... F41A 17/38  
42/6

\* cited by examiner

*Primary Examiner* — Michael A Pratt  
(74) *Attorney, Agent, or Firm* — Che-Yang Chen; Law Offices of Scott Warmuth

(57) **CLAIM**  
The ornamental design for a gun magazine releasing apparatus, as shown and described.

**DESCRIPTION**

FIG. 1 is a perspective view of a gun magazine releasing apparatus showing my new design;  
FIG. 2 is a front elevational view thereof;  
FIG. 3 is a rear elevational view thereof;  
FIG. 4 is a left side elevational view thereof;  
FIG. 5 is a right side elevational view thereof;  
FIG. 6 is a top plan view thereof; and,  
FIG. 7 is a bottom plan view thereof.

- (56) **References Cited**  
U.S. PATENT DOCUMENTS  
D288,279 S \* 2/1987 Chesnut ..... D22/108  
D671,612 S \* 11/2012 Azhocar ..... D22/108  
8,695,477 B2 \* 4/2014 Esch ..... F41A 17/42  
42/14

**1 Claim, 3 Drawing Sheets**

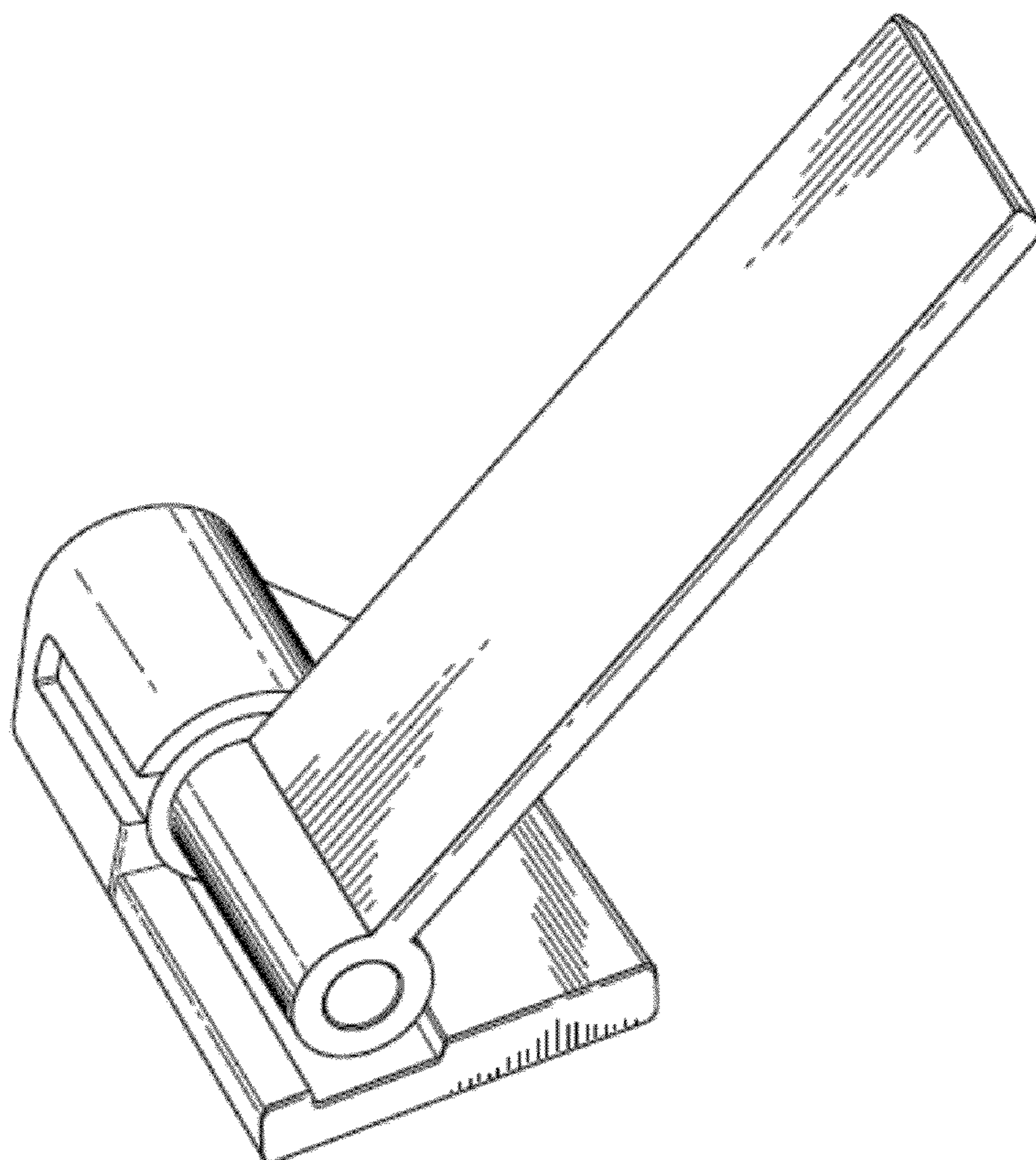

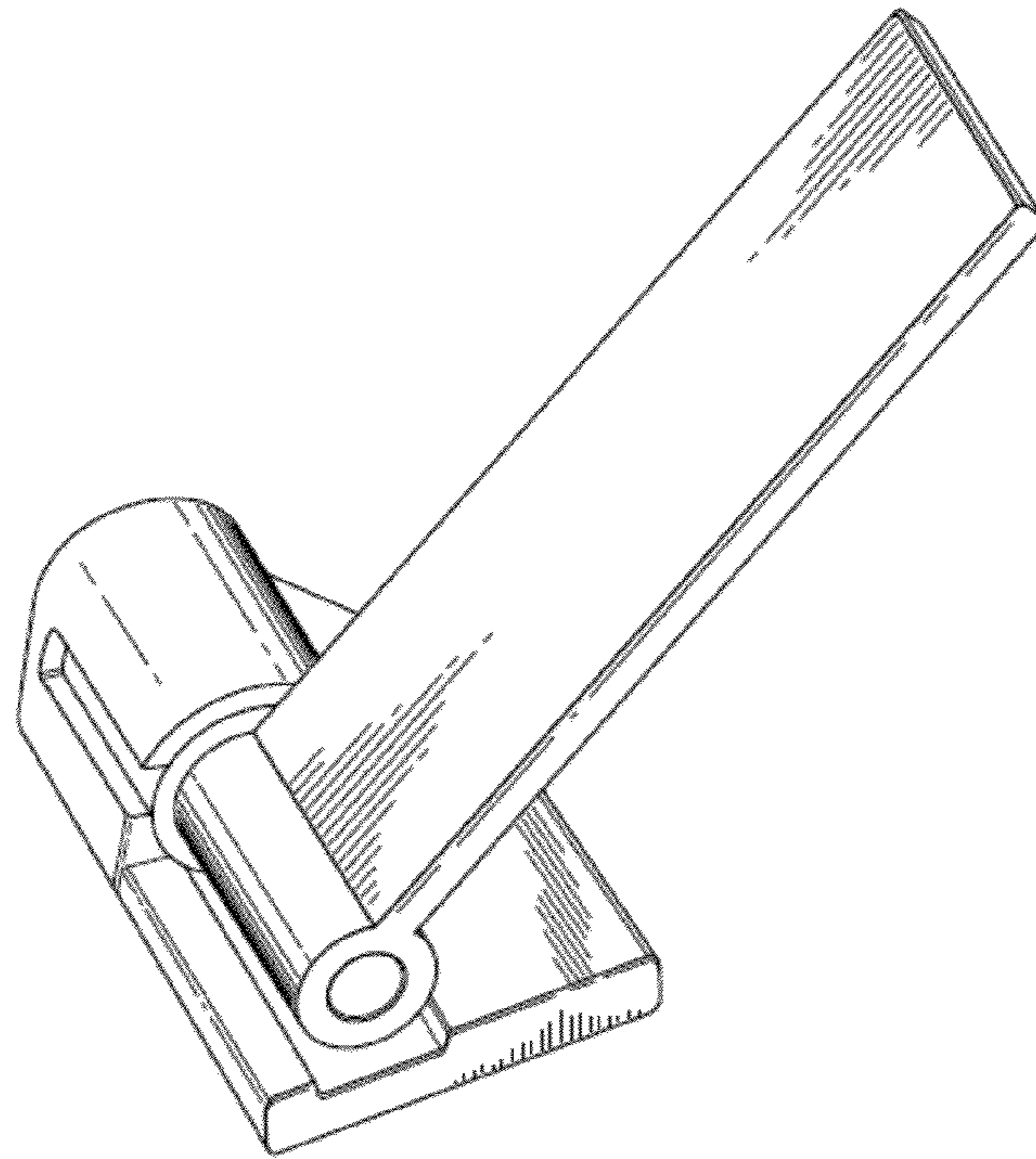

FIG. 1

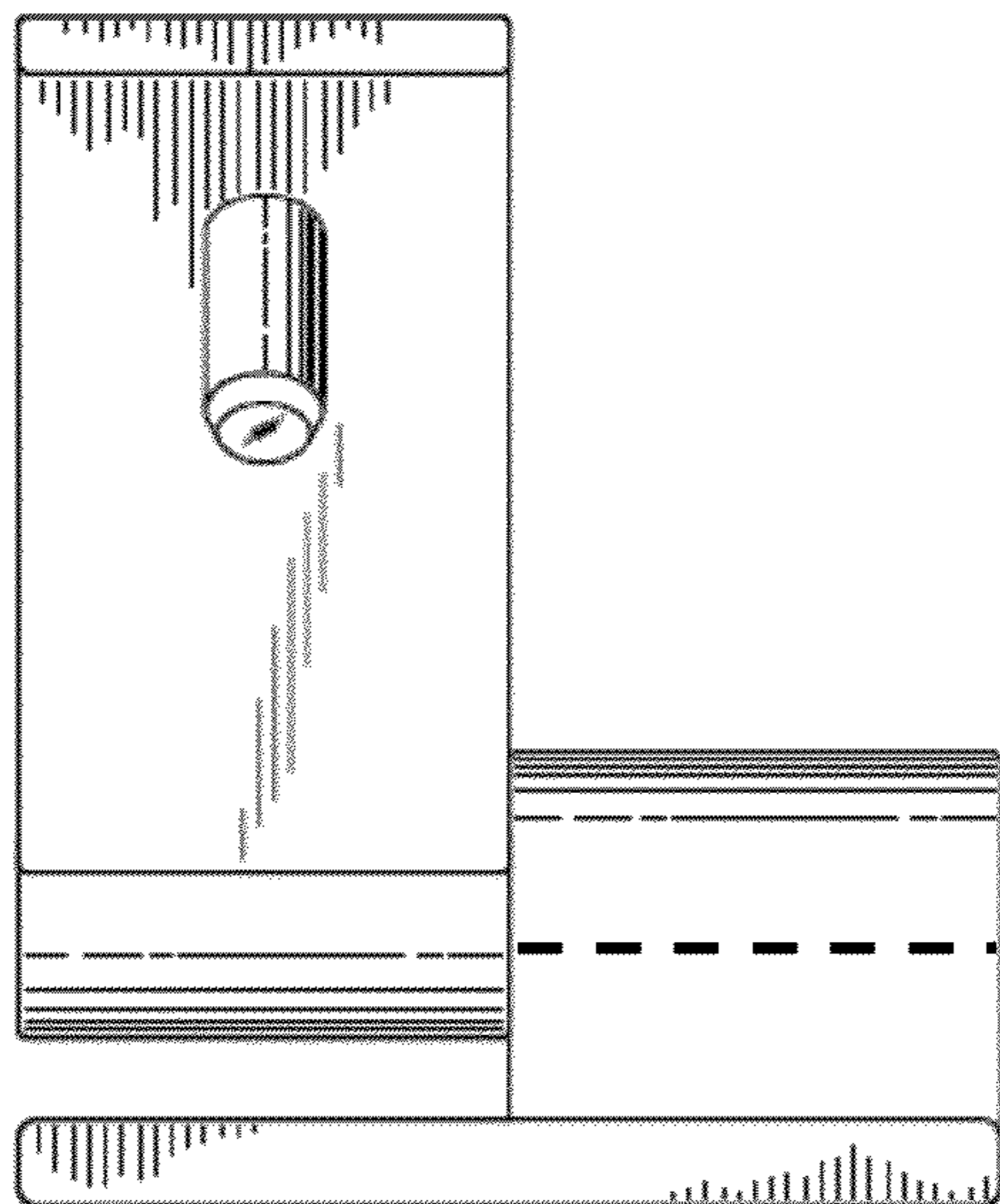

FIG. 2

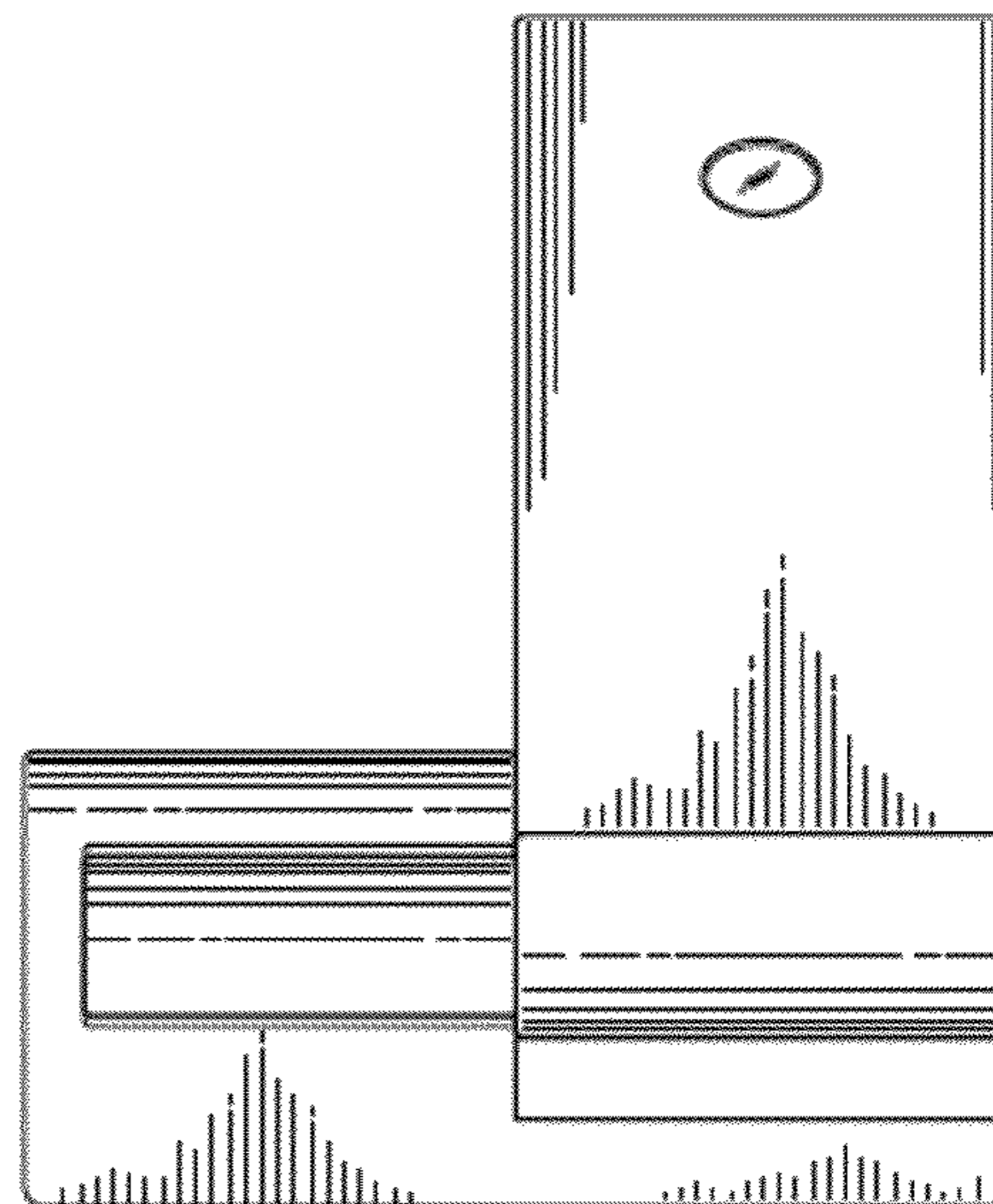

FIG. 3

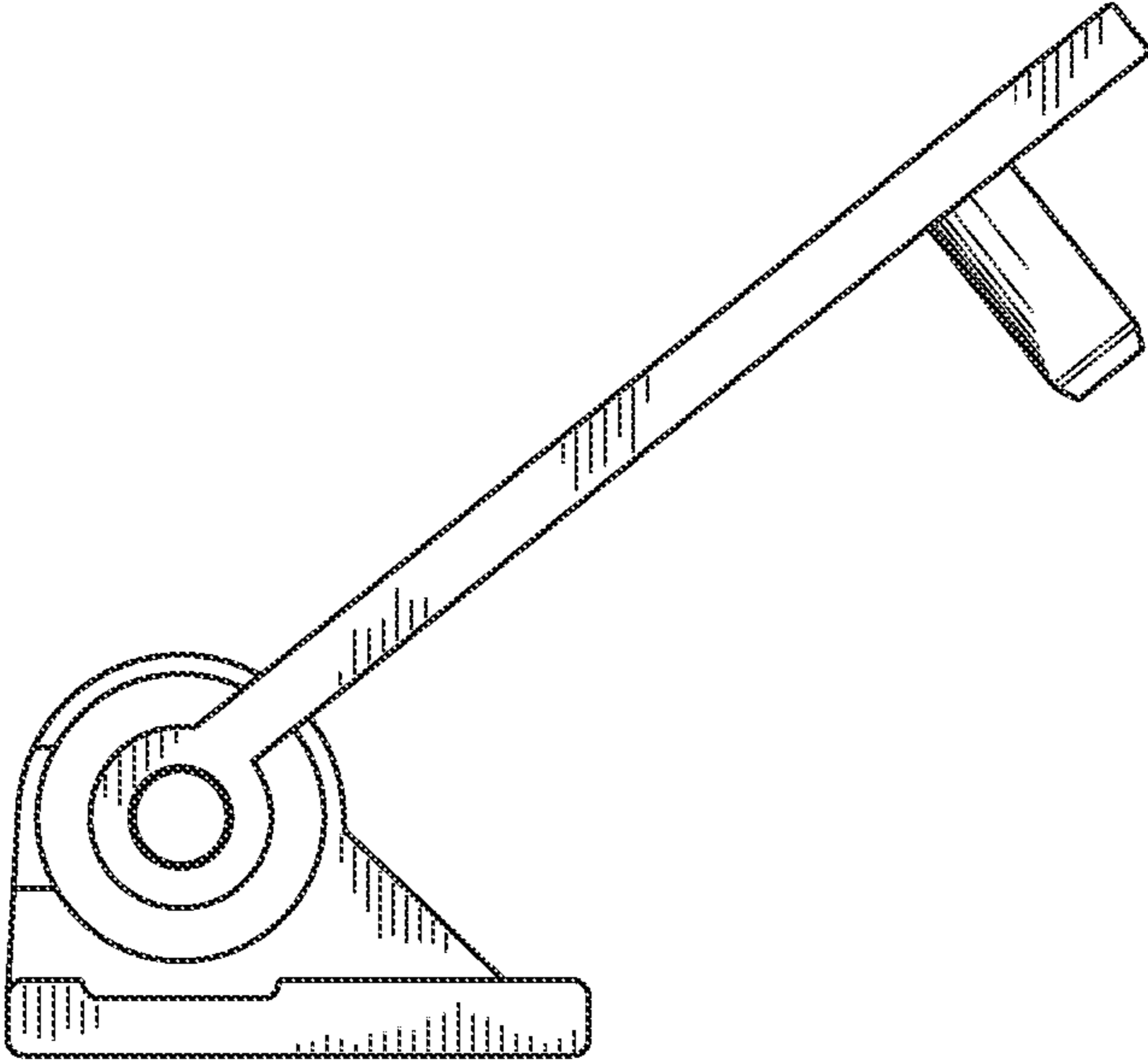

FIG. 4

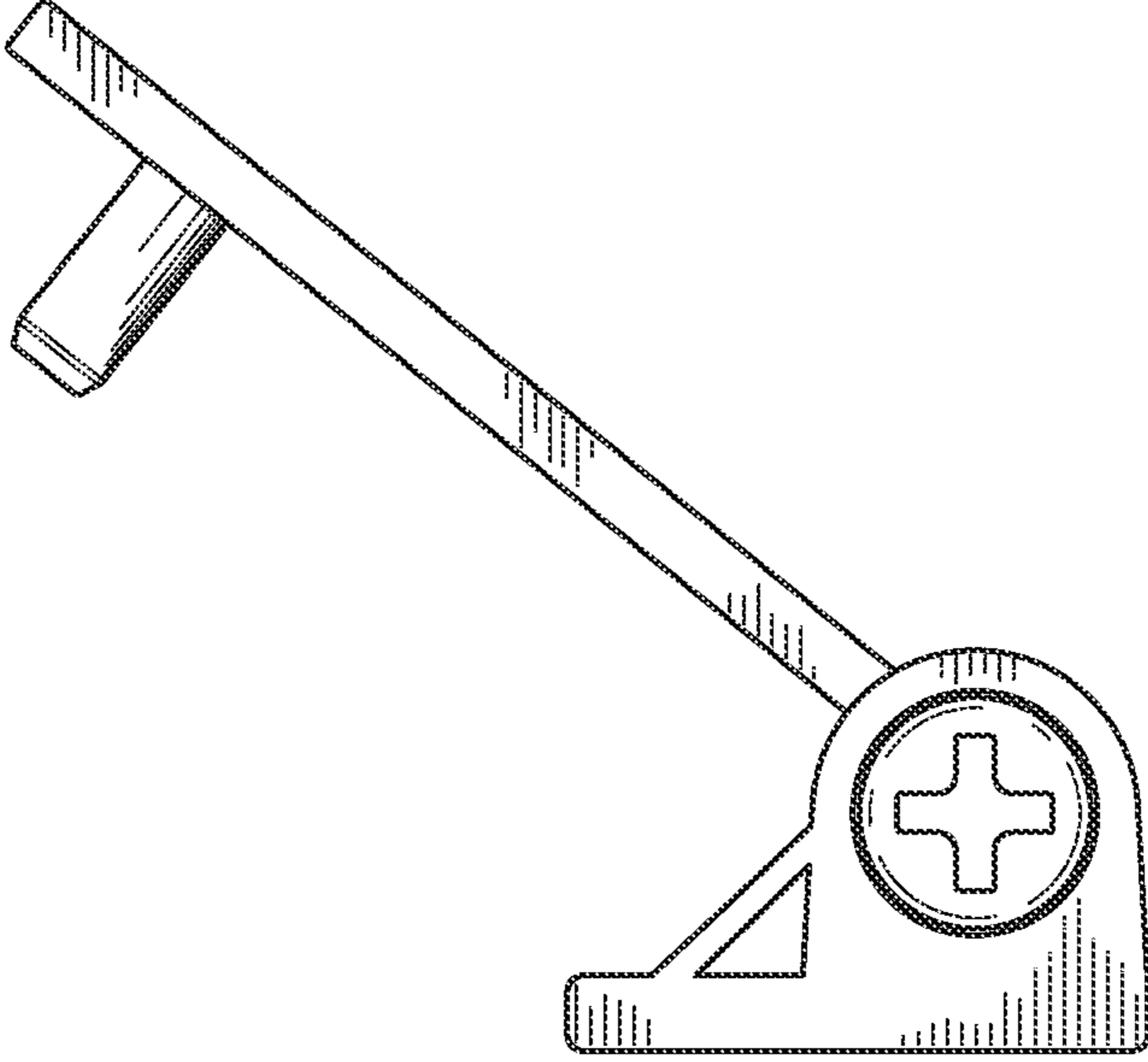

FIG. 5



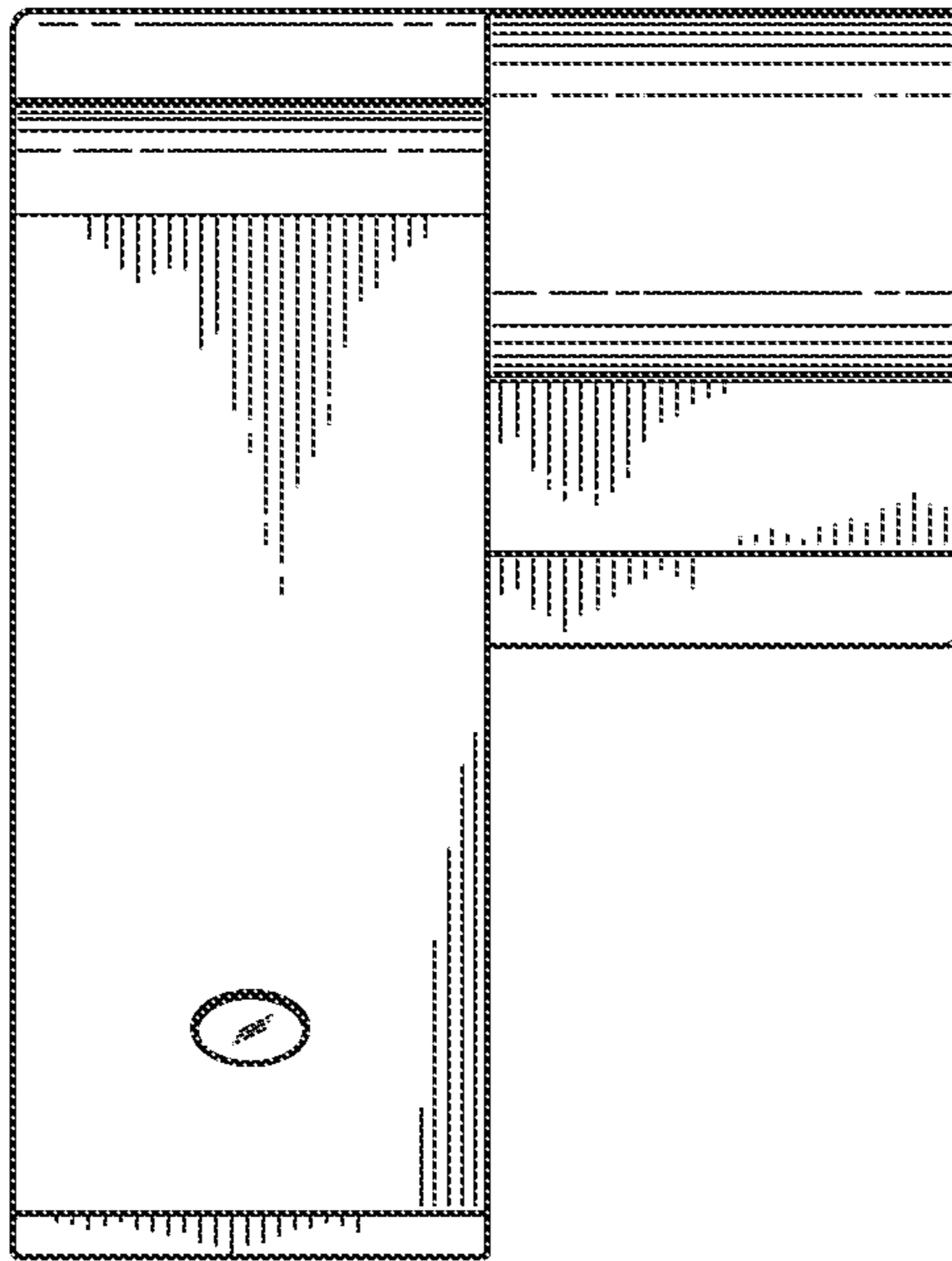

FIG. 6

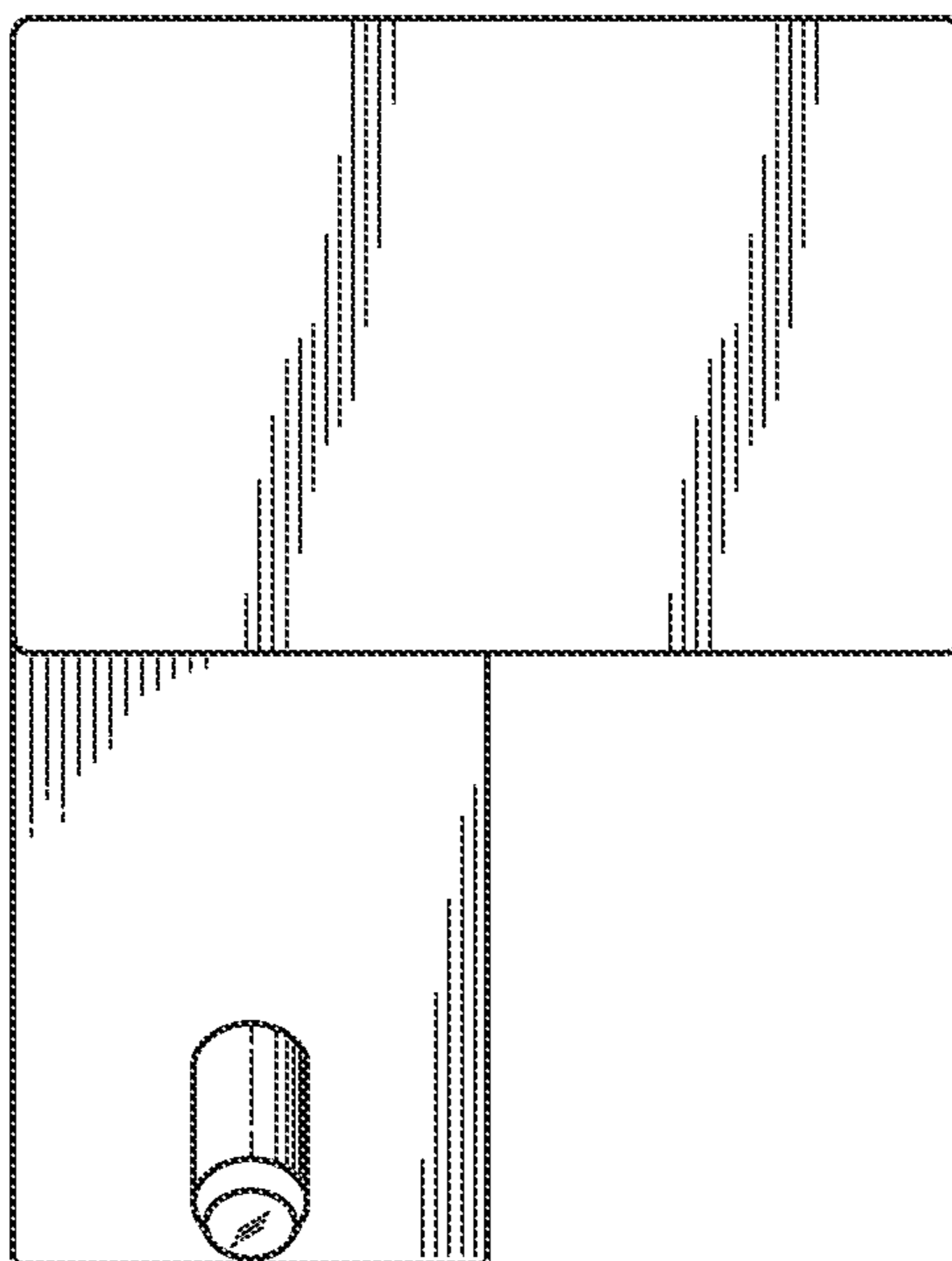

FIG. 7