

US00D760076S

(12) **United States Design Patent**  
**O’Toole et al.**

(10) **Patent No.:** **US D760,076 S**  
(45) **Date of Patent:** **\*\* Jun. 28, 2016**

- (54) **CAP**
- (71) Applicant: **Johnson & Johnson Consumer Inc.,**  
Skillman, NJ (US)
- (72) Inventors: **Timothy S. O’Toole**, Jersey City, NJ  
(US); **Hlynur Atlason**, New York, NY  
(US); **Taylor C. Leishman**, Orem, UT  
(US)
- (73) Assignee: **Johnson & Johnson Consumer Inc.,**  
Skillman, NJ (US)
- (\*\*) Term: **14 Years**
- (21) Appl. No.: **29/510,656**
- (22) Filed: **Dec. 2, 2014**

**Related U.S. Application Data**

- (62) Division of application No. 29/414,078, filed on Feb.  
24, 2012, now Pat. No. Des. 720,991.
- (51) **LOC (10) Cl.** ..... **09-01**
- (52) **U.S. Cl.**  
USPC ..... **D9/435; D9/445; D9/452**
- (58) **Field of Classification Search**  
USPC ..... D9/516, 529–530, 538–539, 541–543,  
D9/549, 552, 558, 565, 571, 574–575, 447,  
D9/449, 452; 215/379, 381–382, 384;  
220/660, 662, 669  
See application file for complete search history.

**References Cited**

**U.S. PATENT DOCUMENTS**

- D83,119 S \* 1/1931 Meyer ..... D11/146
- D86,656 S \* 4/1932 Barbiers ..... D9/569
- D93,070 S \* 8/1934 Westlake ..... D9/544

- D96,782 S \* 9/1935 Sloan ..... D3/294
- D102,283 S 12/1936 Marrow
- D116,214 S 8/1939 Bergaud
- D118,157 S 12/1939 Jung
- D144,612 S 5/1946 Derham
- D145,512 S 9/1946 Derham
- D155,260 S 9/1949 Baron
- D155,358 S \* 9/1949 Pavlinetz ..... D9/454
- D222,611 S 11/1971 Strand
- D256,332 S \* 8/1980 Messina ..... D9/552 X

(Continued)

*Primary Examiner* — Carol P Rademaker

(57) **CLAIM**

The ornamental design for a cap, as shown and described.

**DESCRIPTION**

FIG. 1 is a front, right and top perspective view of a first embodiment of a cap showing our new design;  
 FIG. 2 is a front elevational view of the cap of FIG. 1;  
 FIG. 3 is a back elevational view of the cap of FIG. 1;  
 FIG. 4 is a left side elevational view of the cap of FIG. 1;  
 FIG. 5 is a right side elevational view of the cap of FIG. 1;  
 FIG. 6 is a top plan view of the cap of FIG. 1;  
 FIG. 7 is a front, right and top perspective view of a second embodiment of a cap showing our new design;  
 FIG. 8 is a front elevational view of the cap of FIG. 7;  
 FIG. 9 is a back elevational view of the cap of FIG. 7;  
 FIG. 10 is a left side elevational view of the cap of FIG. 7;  
 FIG. 11 is a right side elevational view of the cap of FIG. 7;  
 and,  
 FIG. 12 is a top plan view of the cap of FIG. 7.  
 The dotted lines are included for the purpose of illustrating portions of the cap that form no part of the claimed design, with the dot-dash lines being representative of boundary between claimed and unclaimed subject matter.

**1 Claim, 6 Drawing Sheets**

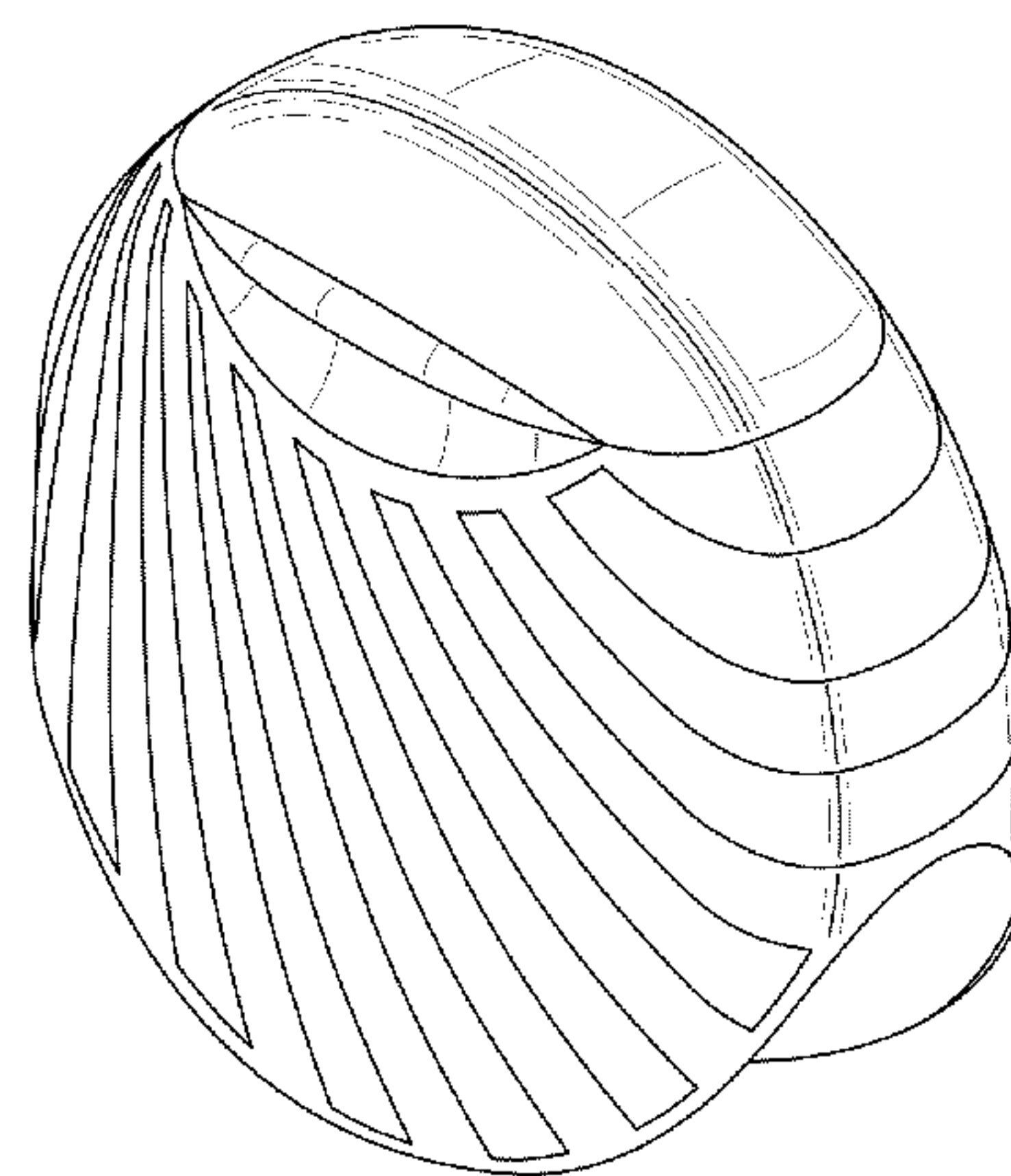
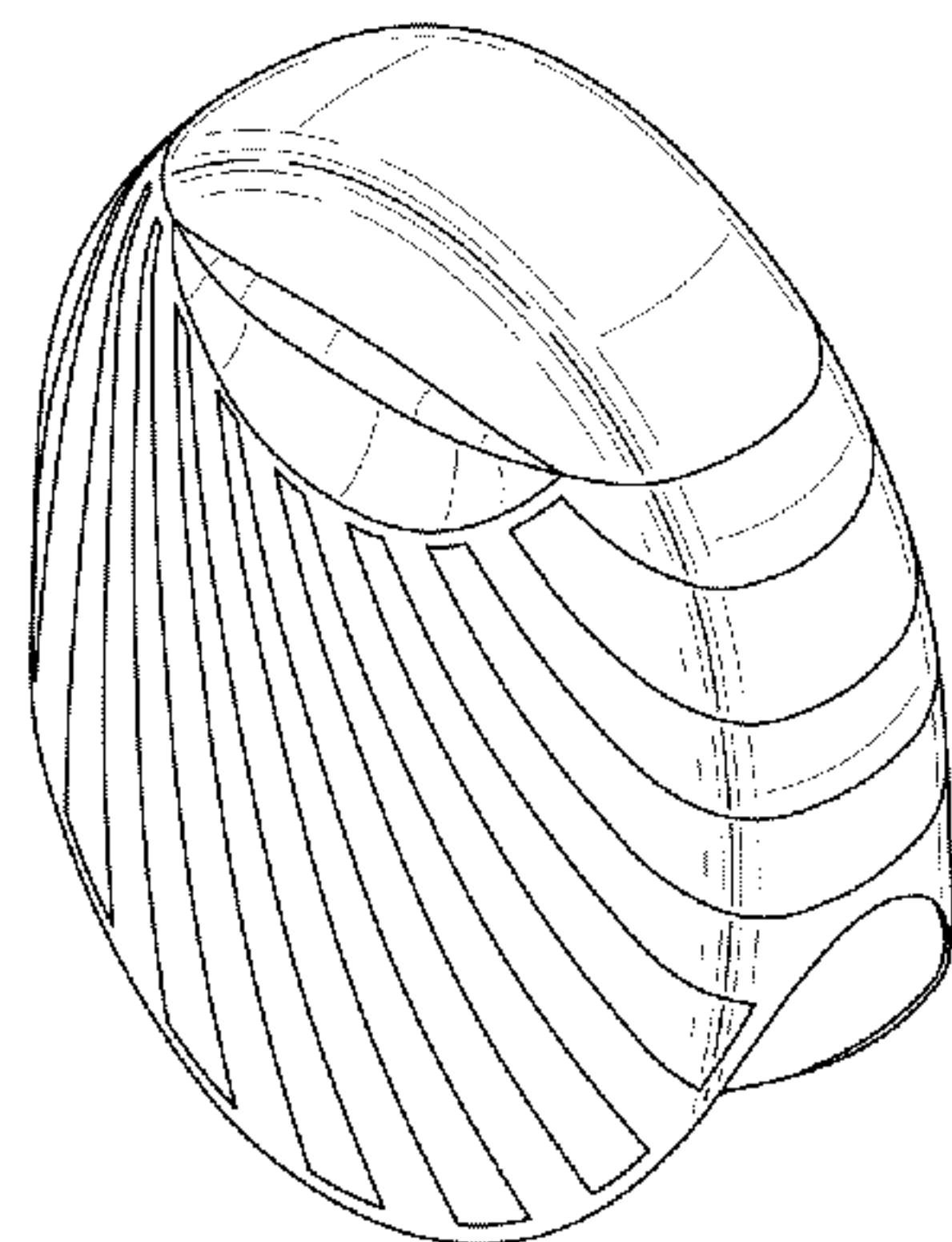

(56)

References Cited

U.S. PATENT DOCUMENTS

D270,138 S \* 8/1983 Rosen ..... D9/544  
 D275,838 S \* 10/1984 Rosen ..... D9/435  
 D284,548 S \* 7/1986 Rosen ..... D9/435  
 D286,273 S \* 10/1986 Pozzi ..... D11/143  
 D288,663 S 3/1987 Thieffry  
 D290,229 S \* 6/1987 Rosen ..... D9/529  
 D316,223 S \* 4/1991 Dinand ..... D9/575 X  
 D322,217 S \* 12/1991 Dinand ..... D9/435  
 D325,701 S 4/1992 van Lit  
 D357,632 S \* 4/1995 Dinand ..... D9/452  
 D372,396 S 8/1996 Seager  
 D375,455 S \* 11/1996 Uhl ..... D9/529 X  
 D420,285 S \* 2/2000 Sagan ..... D9/435 X  
 D453,685 S \* 2/2002 Lane ..... D9/552  
 D462,013 S \* 8/2002 Iizuka ..... D9/538  
 D471,809 S \* 3/2003 Poisson ..... D9/435

D476,888 S \* 7/2003 Poisson ..... D9/445 X  
 D477,220 S \* 7/2003 Poisson ..... D9/445 X  
 D478,507 S \* 8/2003 Poisson ..... D9/445 X  
 D546,179 S \* 7/2007 Kunesh ..... D9/445  
 D550,078 S \* 9/2007 Henry ..... D9/435  
 D562,134 S 2/2008 Studee  
 D584,148 S 1/2009 Stolle  
 D589,801 S 4/2009 Lablaine  
 D589,802 S 4/2009 Lablaine  
 D590,265 S 4/2009 Lablaine  
 D604,625 S 11/2009 Lablaine  
 D604,627 S 11/2009 Lablaine  
 D605,043 S 12/2009 Lablaine  
 D605,511 S 12/2009 Weber  
 D605,513 S 12/2009 Weber  
 D645,348 S \* 9/2011 Borghesi ..... D9/445  
 D653,954 S \* 2/2012 Arad ..... D9/565 X  
 D738,216 S \* 9/2015 Martz ..... D9/451  
 D738,725 S \* 9/2015 Isaris ..... D9/452

\* cited by examiner

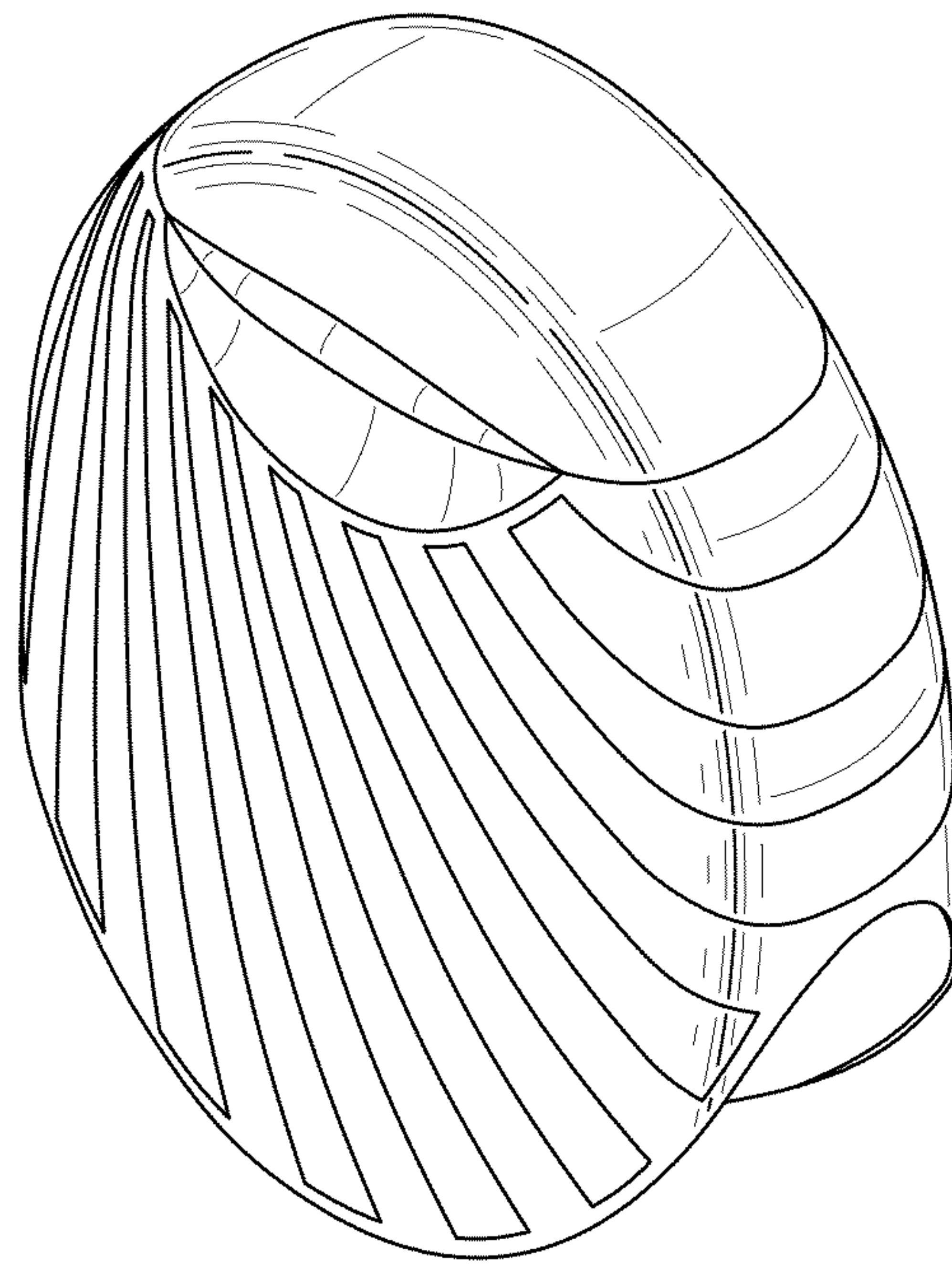

Fig. 1

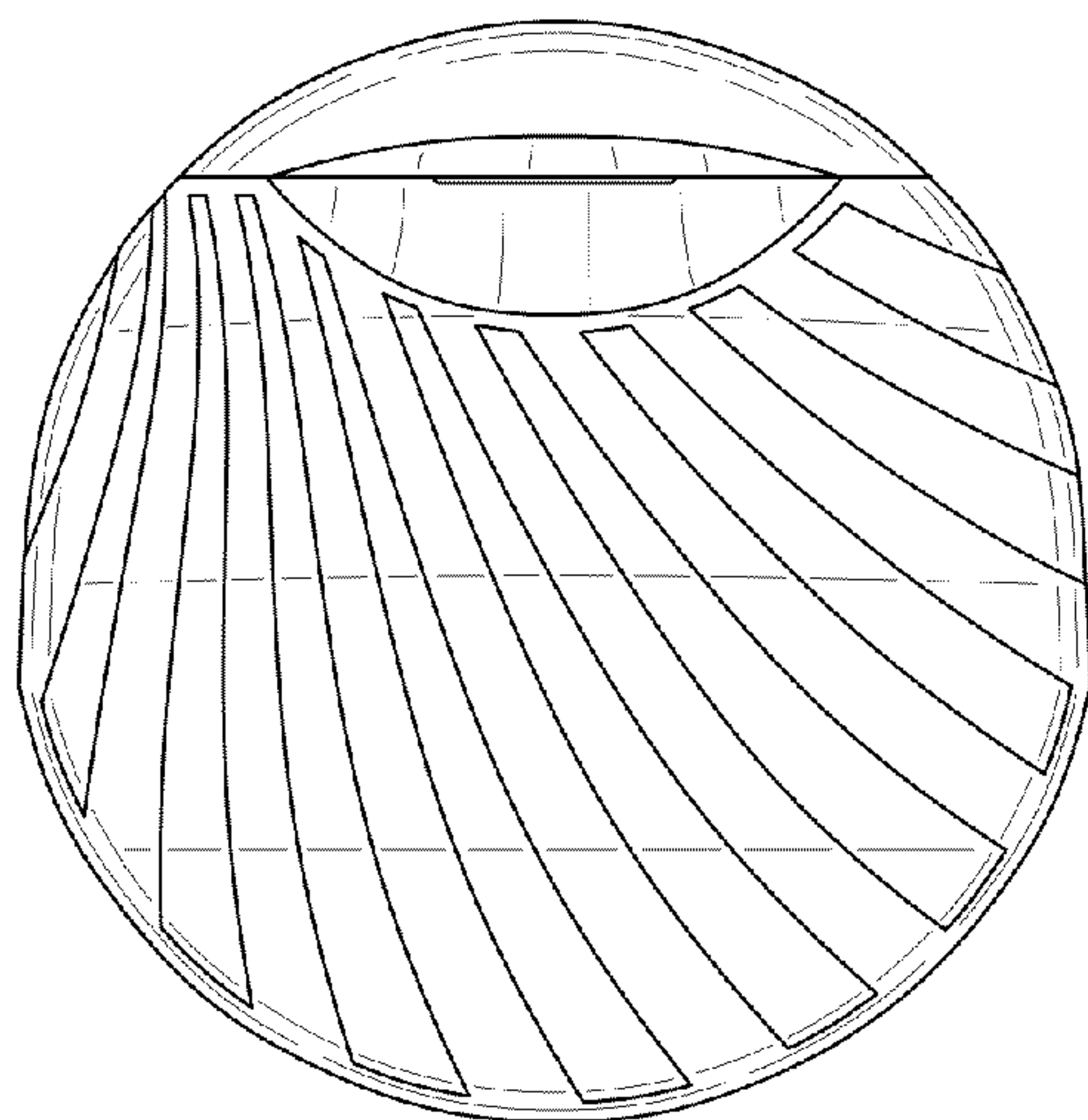

Fig. 2

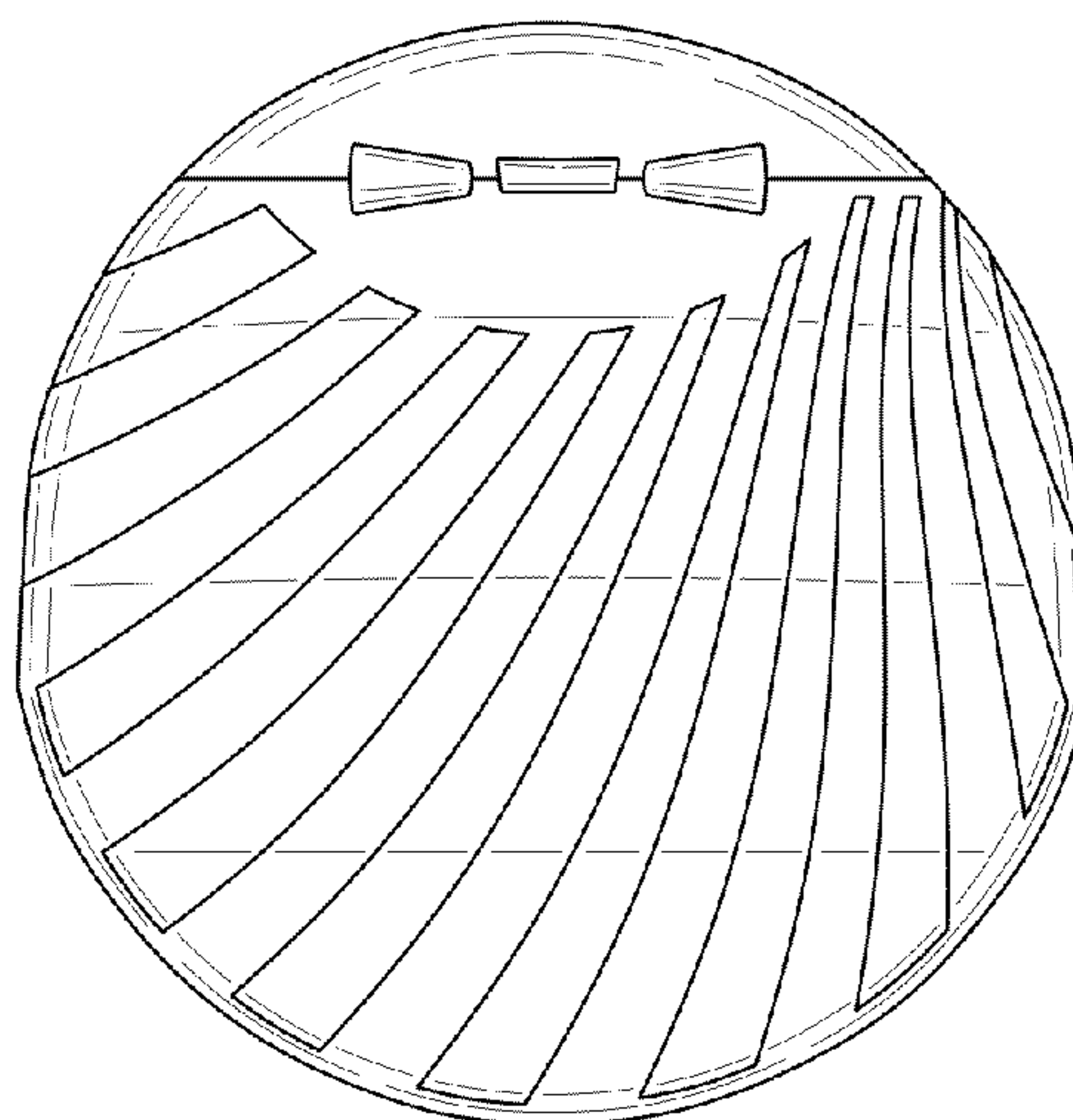

Fig. 3



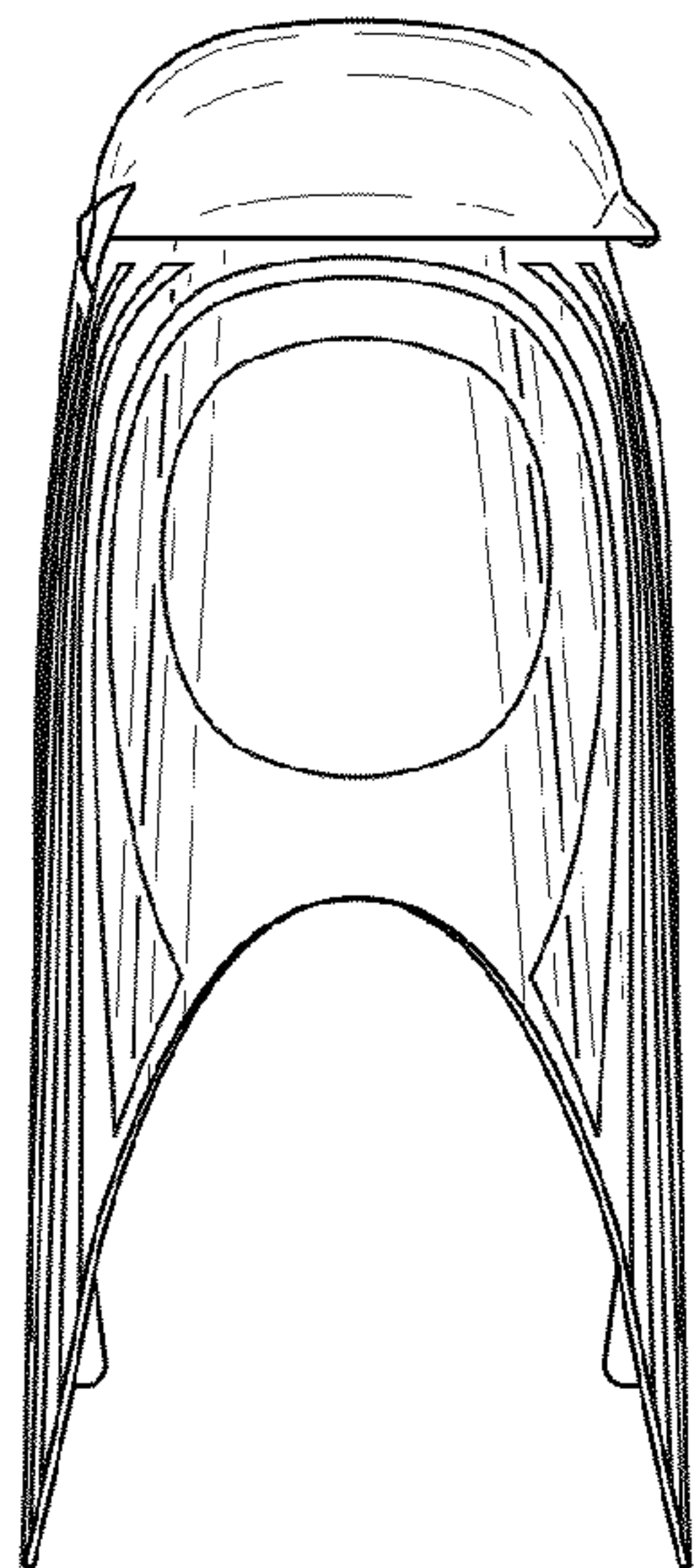

Fig. 4

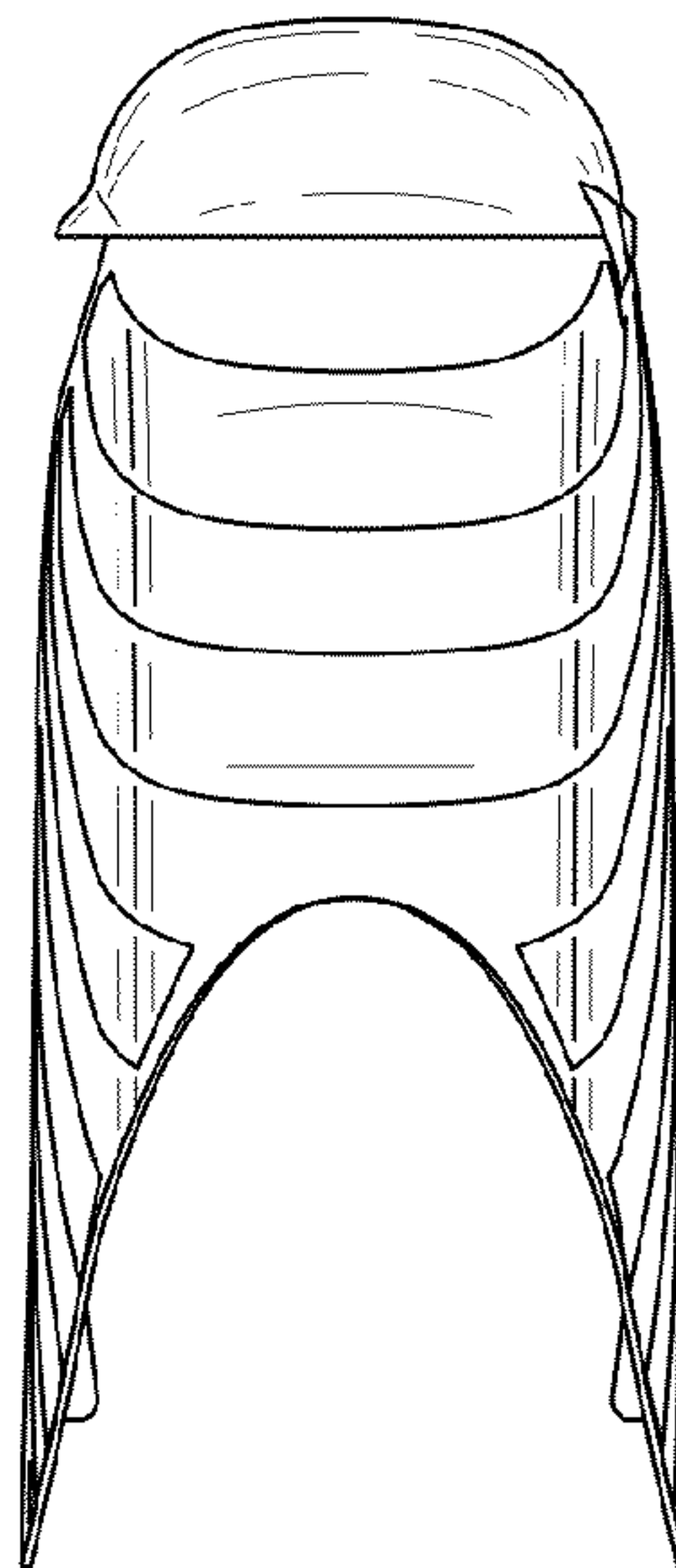

Fig. 5

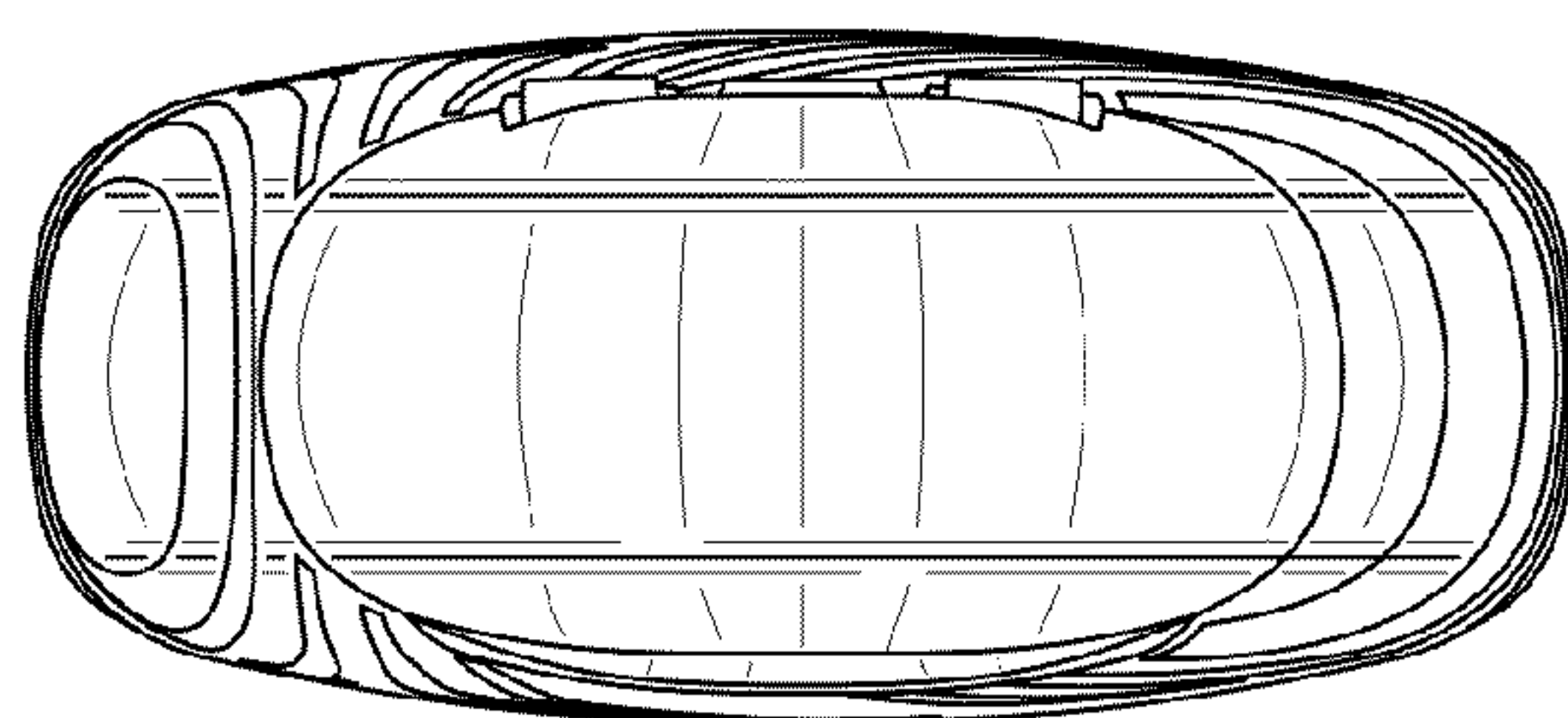

Fig. 6

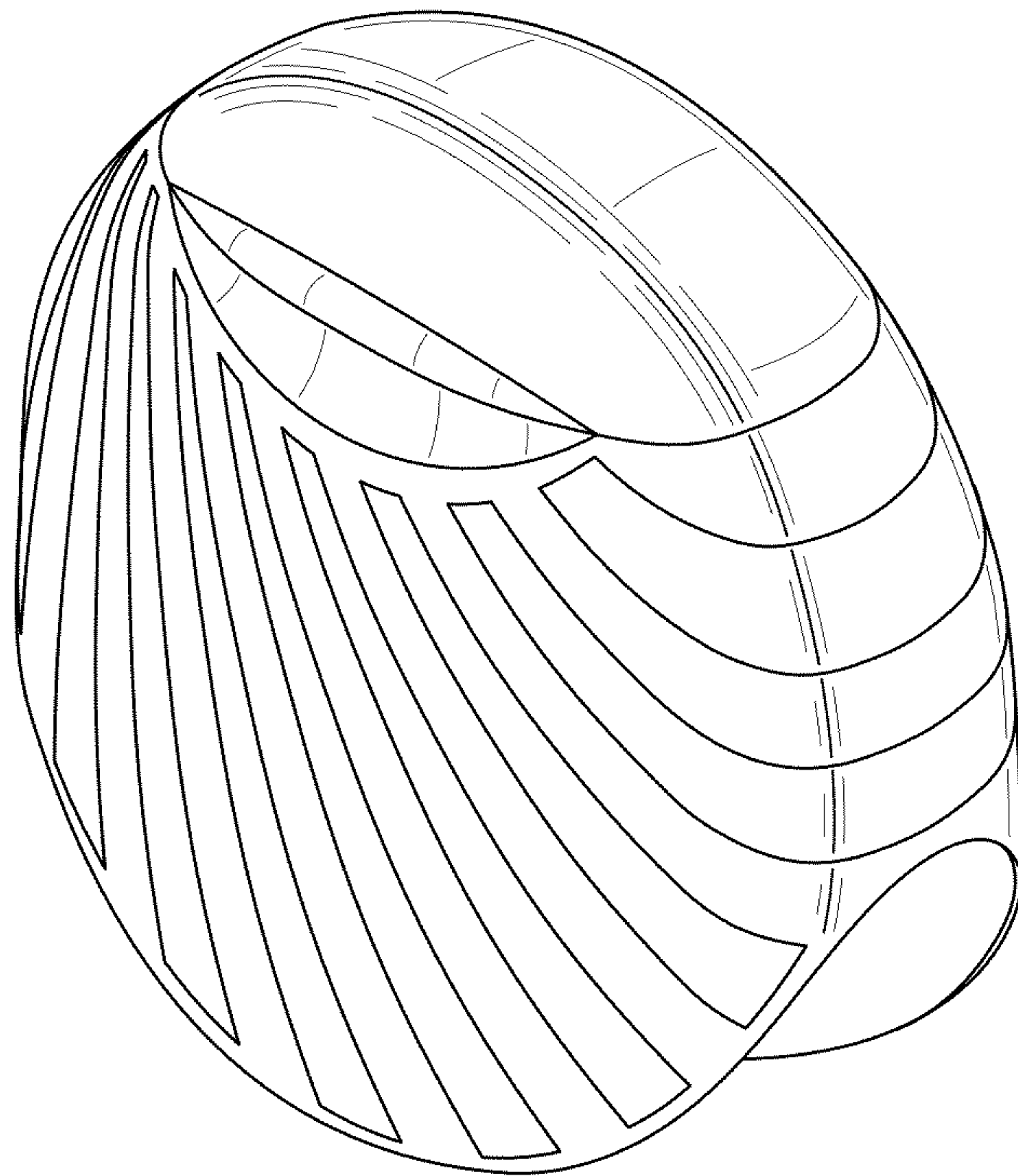

Fig. 7

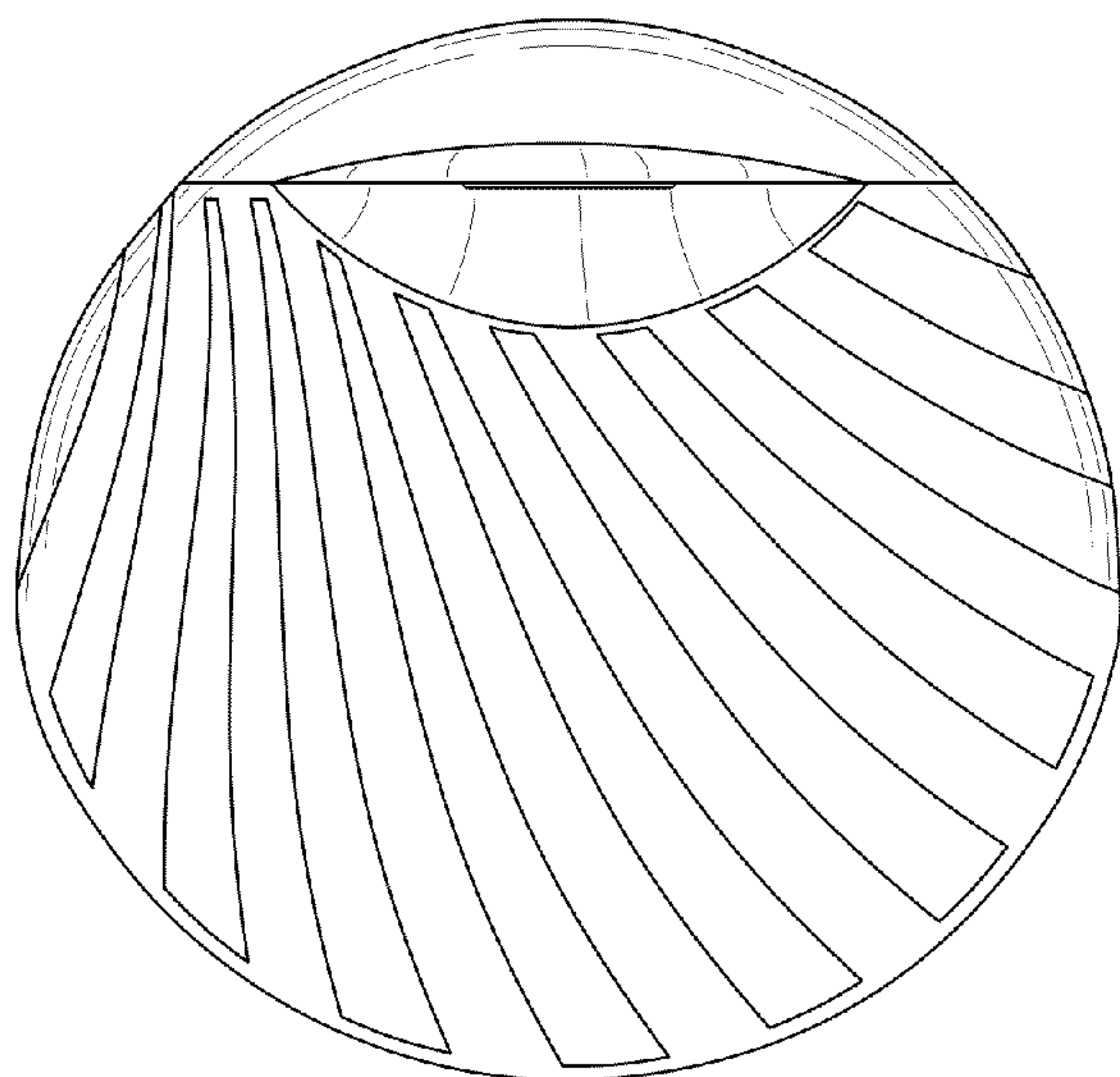

Fig. 8

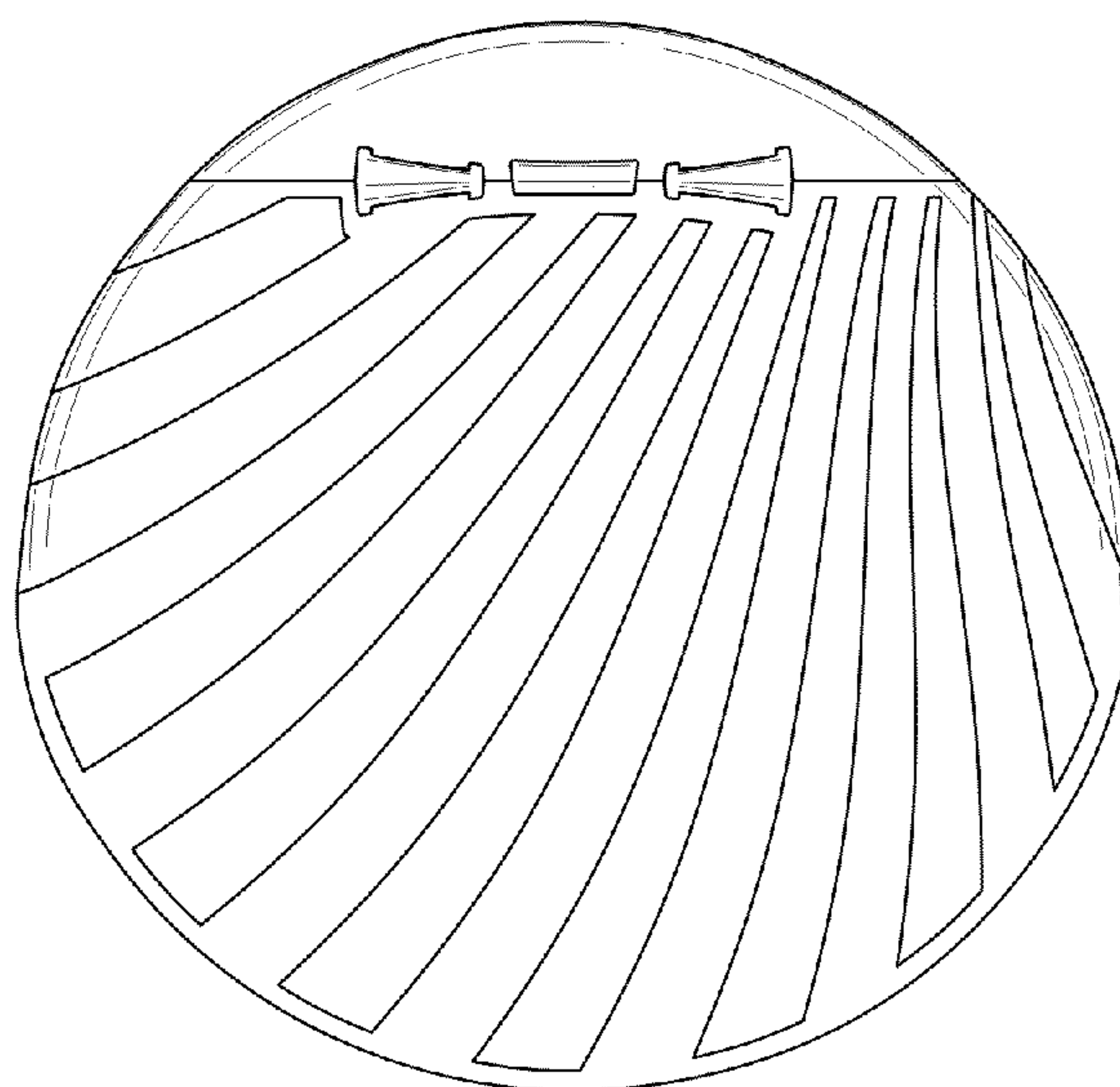

Fig. 9

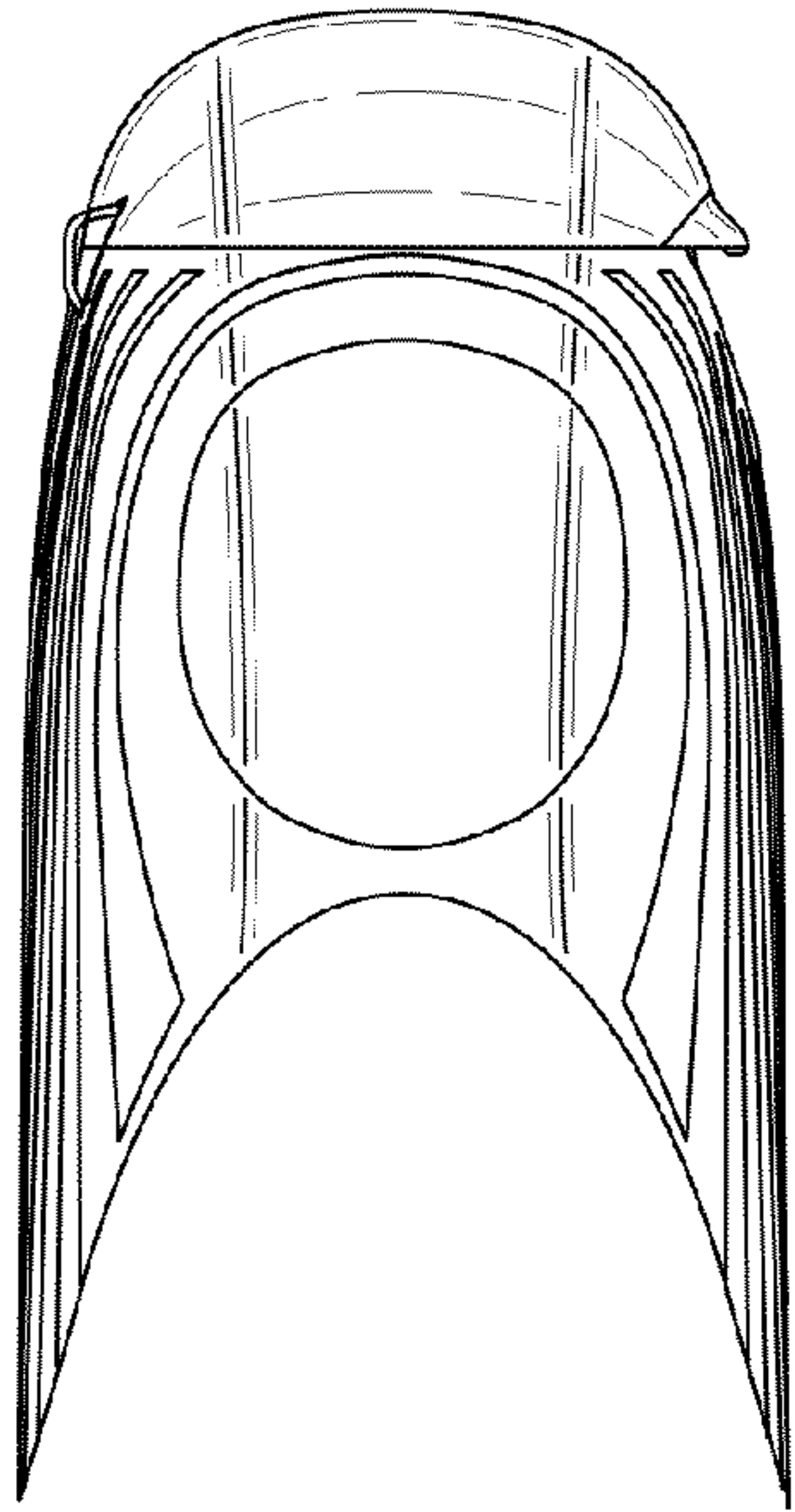

Fig. 10

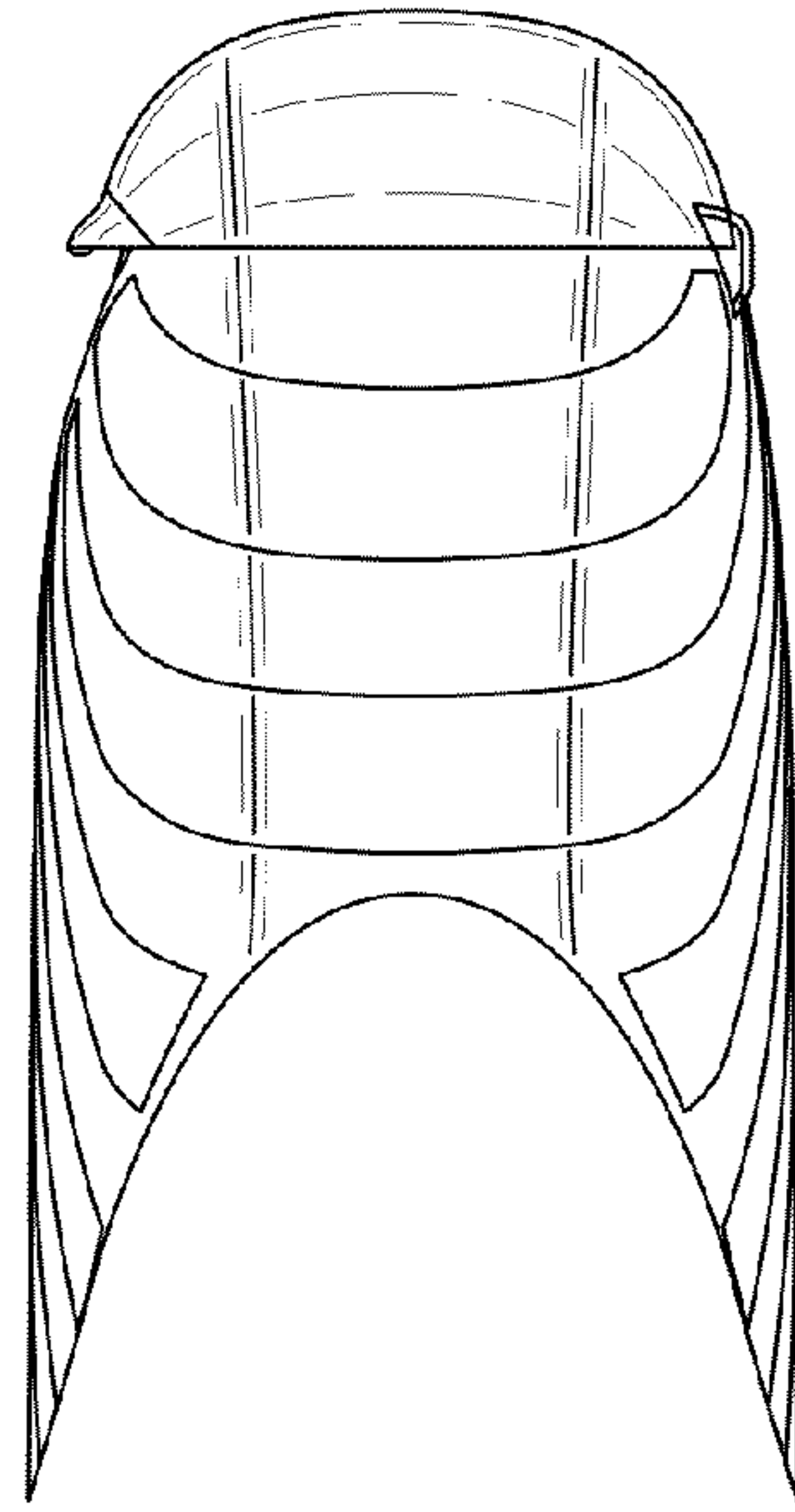

Fig. 11

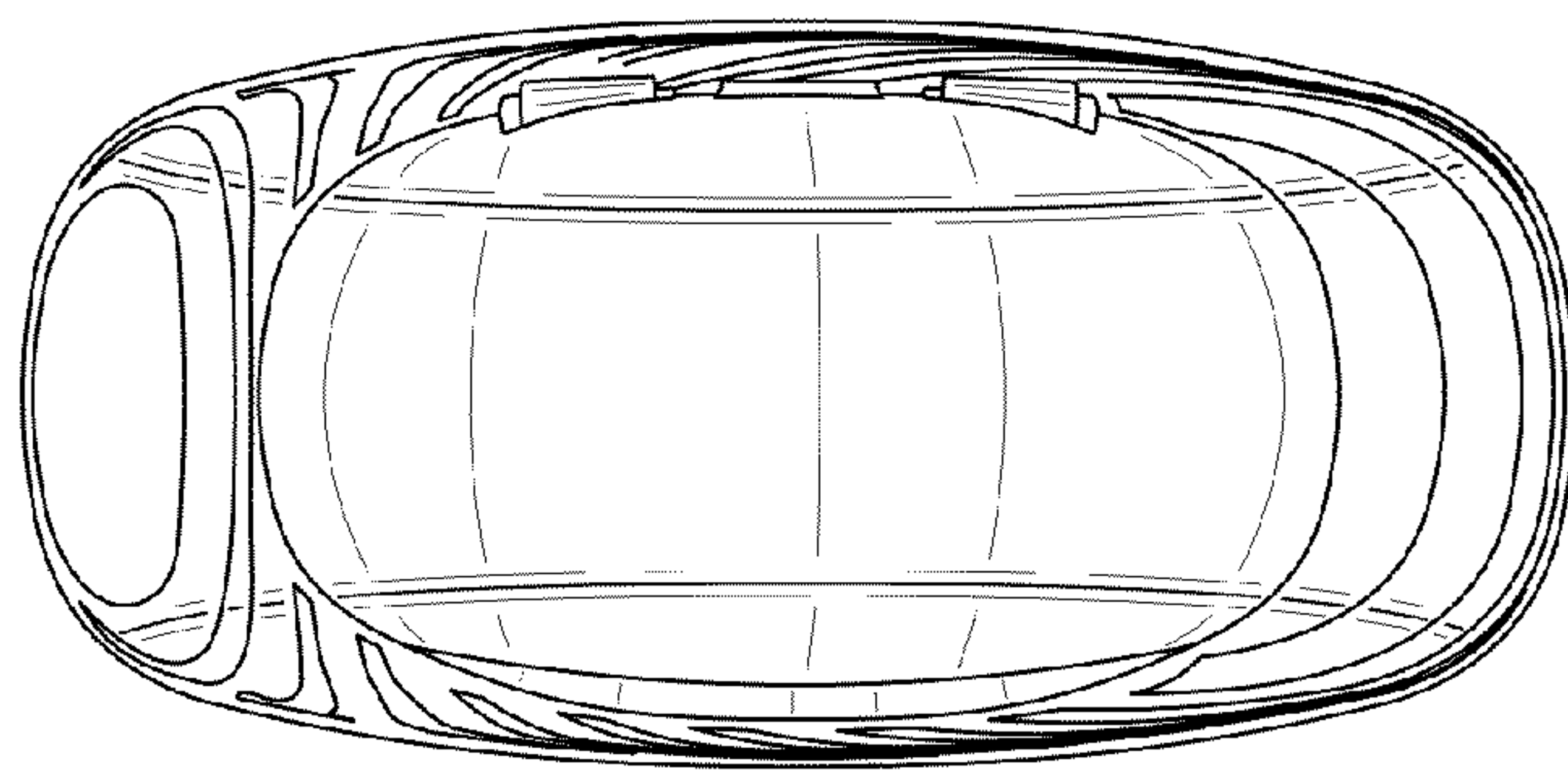

Fig. 12