



US00D759967S

(12) **United States Design Patent**
Schug et al.

(10) **Patent No.:** **US D759,967 S**
(45) **Date of Patent:** **** Jun. 28, 2016**

- (54) **BASEBALL GLOVE HOLDER**
- (71) Applicants: **Chad Schug**, Yorba Linda, CA (US);
Ryan Ackland, Yorba Linda, CA (US)
- (72) Inventors: **Chad Schug**, Yorba Linda, CA (US);
Ryan Ackland, Yorba Linda, CA (US)
- (**) Term: **14 Years**
- (21) Appl. No.: **29/524,852**
- (22) Filed: **Apr. 23, 2015**
- (51) **LOC (10) Cl.** **03-01**
- (52) **U.S. Cl.**
USPC **D3/254**
- (58) **Field of Classification Search**
USPC D3/354, 201
CPC A63B 71/0036; A63B 71/143
See application file for complete search history.

5,868,368 A * 2/1999 MacDonald A63B 71/0036
211/33
D734,028 S * 7/2015 Noble D3/254
* cited by examiner

Primary Examiner — Mitchell Siegel
(74) *Attorney, Agent, or Firm* — Dunlap, Bennett & Ludwig
PLLC

(57) **CLAIM**
The ornamental design for a baseball glove holder, as shown
and described.

DESCRIPTION

FIG. 1 is an isometric view of a baseball glove holder;
FIG. 2 is a front elevation view thereof;
FIG. 3 is a rear elevation view thereof;
FIG. 4 is a left elevation view thereof; the right elevation view
being a mirror image thereof;
FIG. 5 is a top elevation view thereof; and,
FIG. 6 is a bottom elevation view thereof.
The broken lines shown in the drawings illustrate portions of
the baseball glove holder that form no part of the claimed
design.

- (56) **References Cited**
U.S. PATENT DOCUMENTS
4,418,849 A * 12/1983 Santa A63B 71/143
2/19
4,637,610 A * 1/1987 Carr A63B 69/0002
2/19

1 Claim, 3 Drawing Sheets

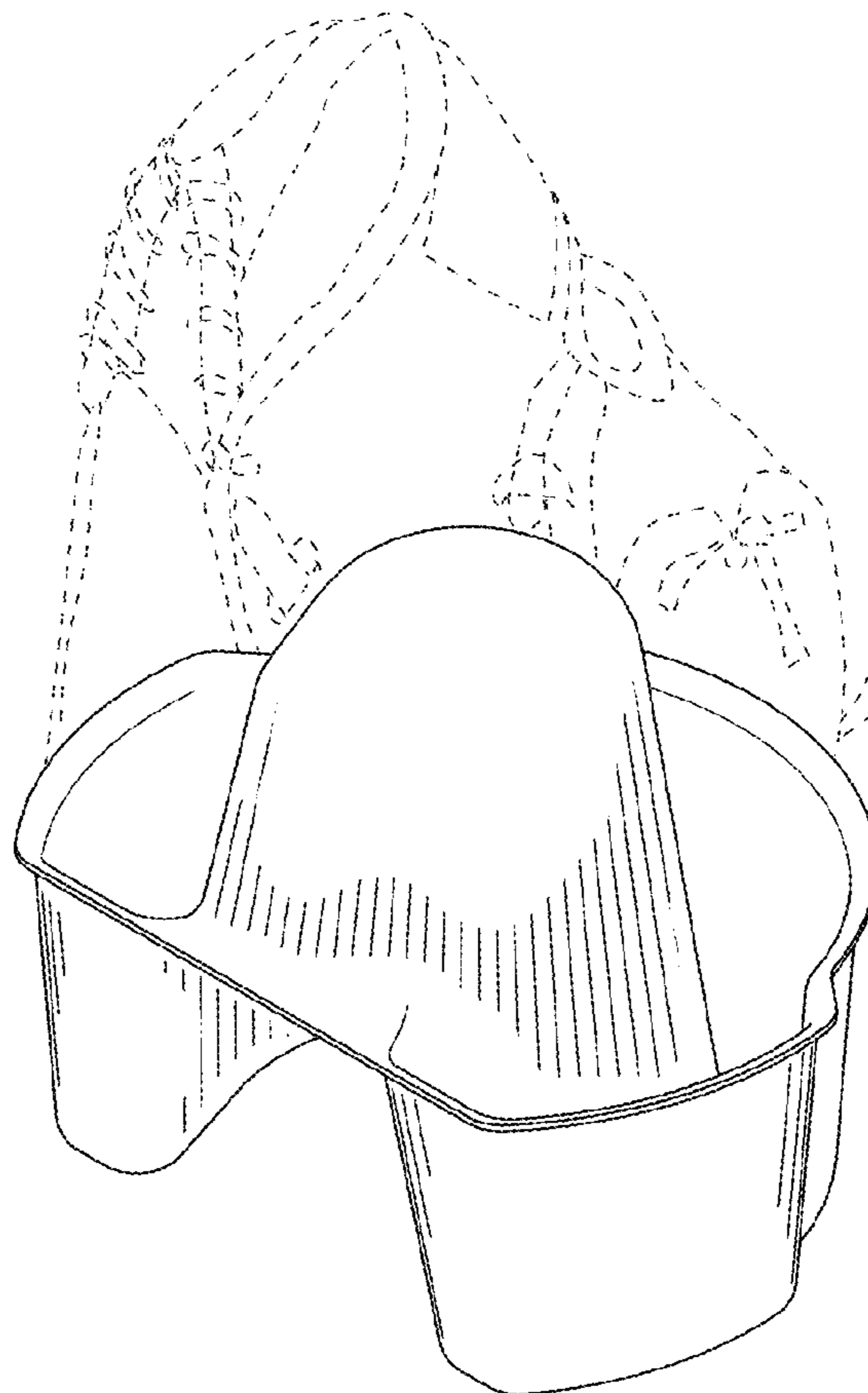

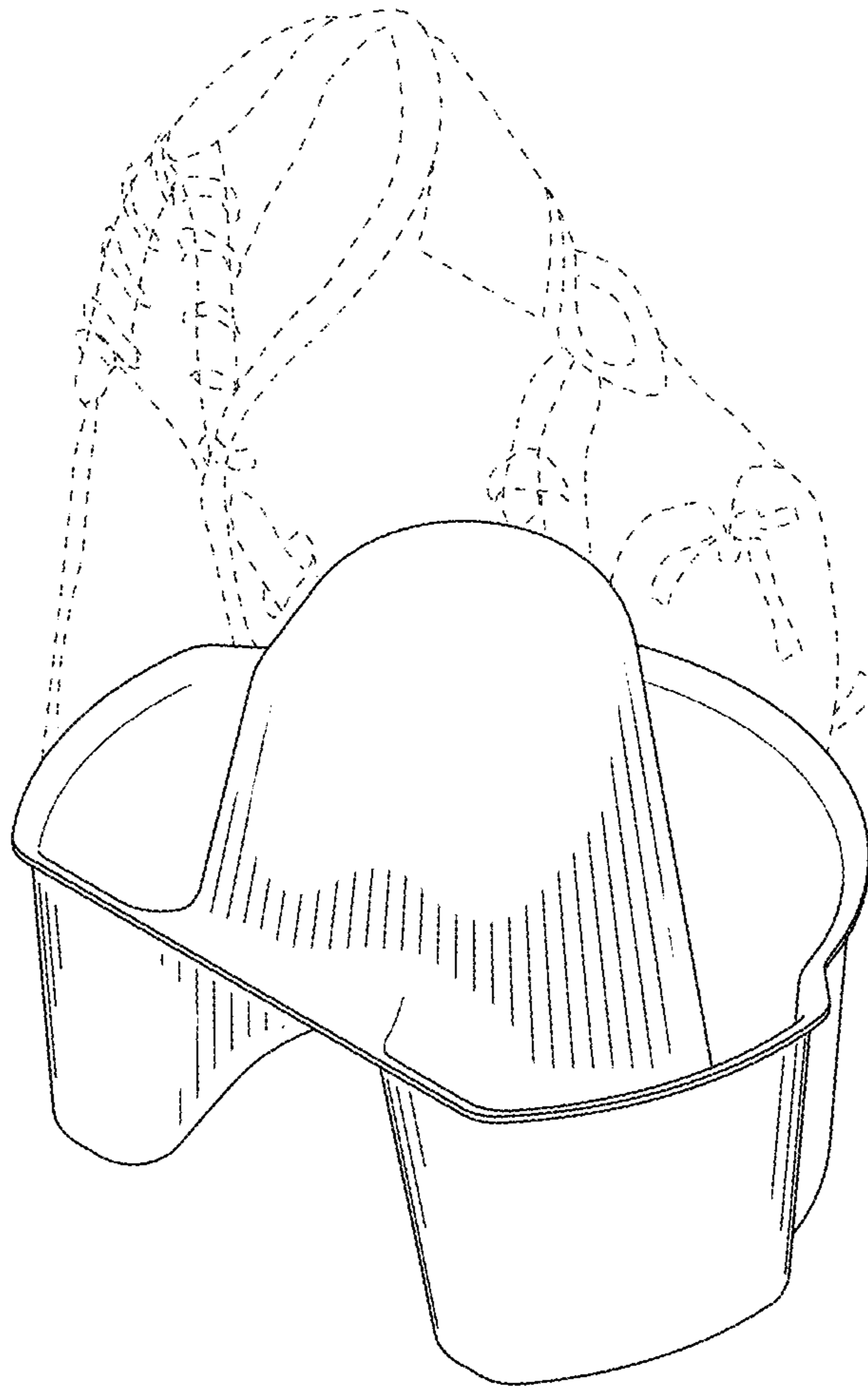

FIG. 1

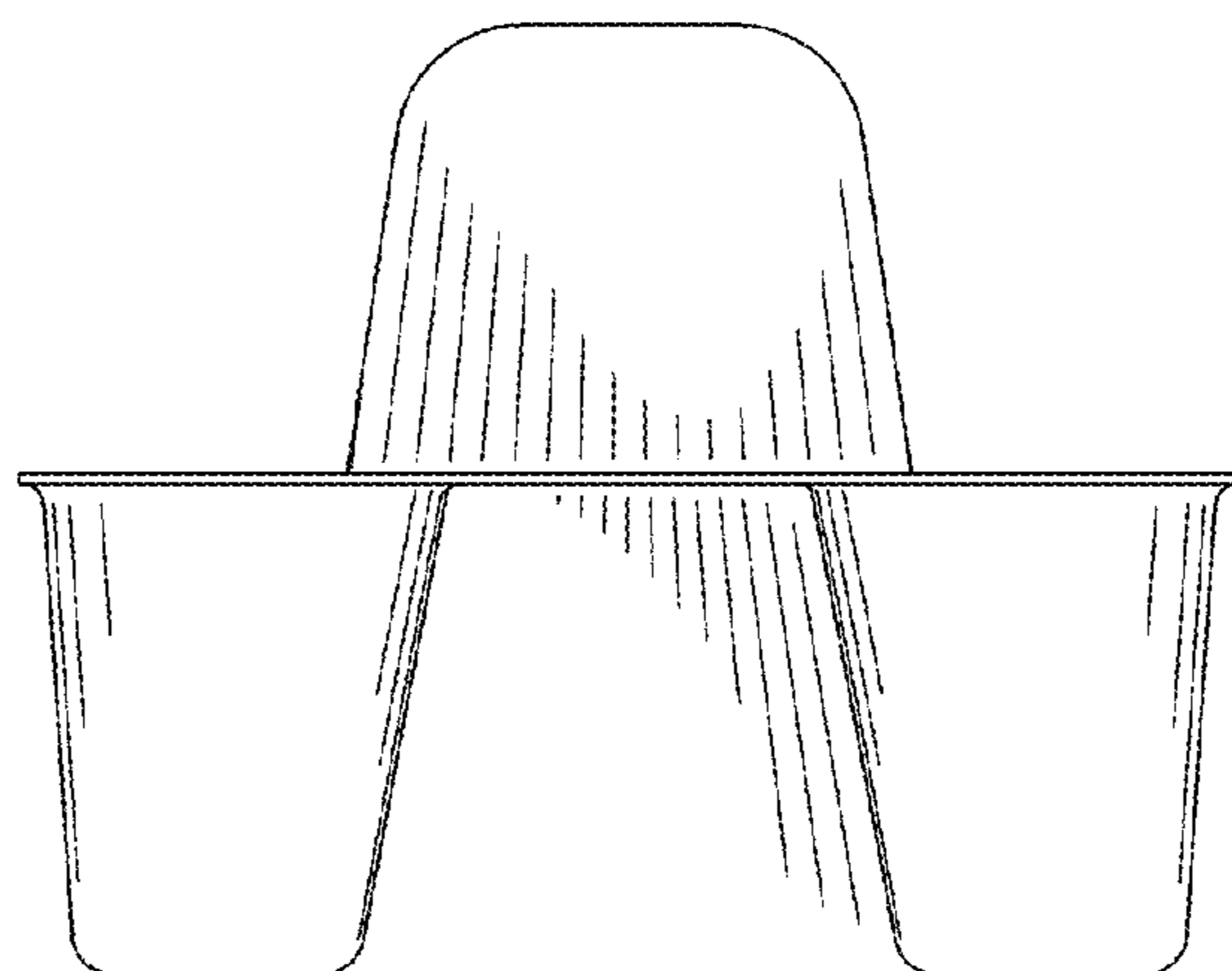

FIG. 2

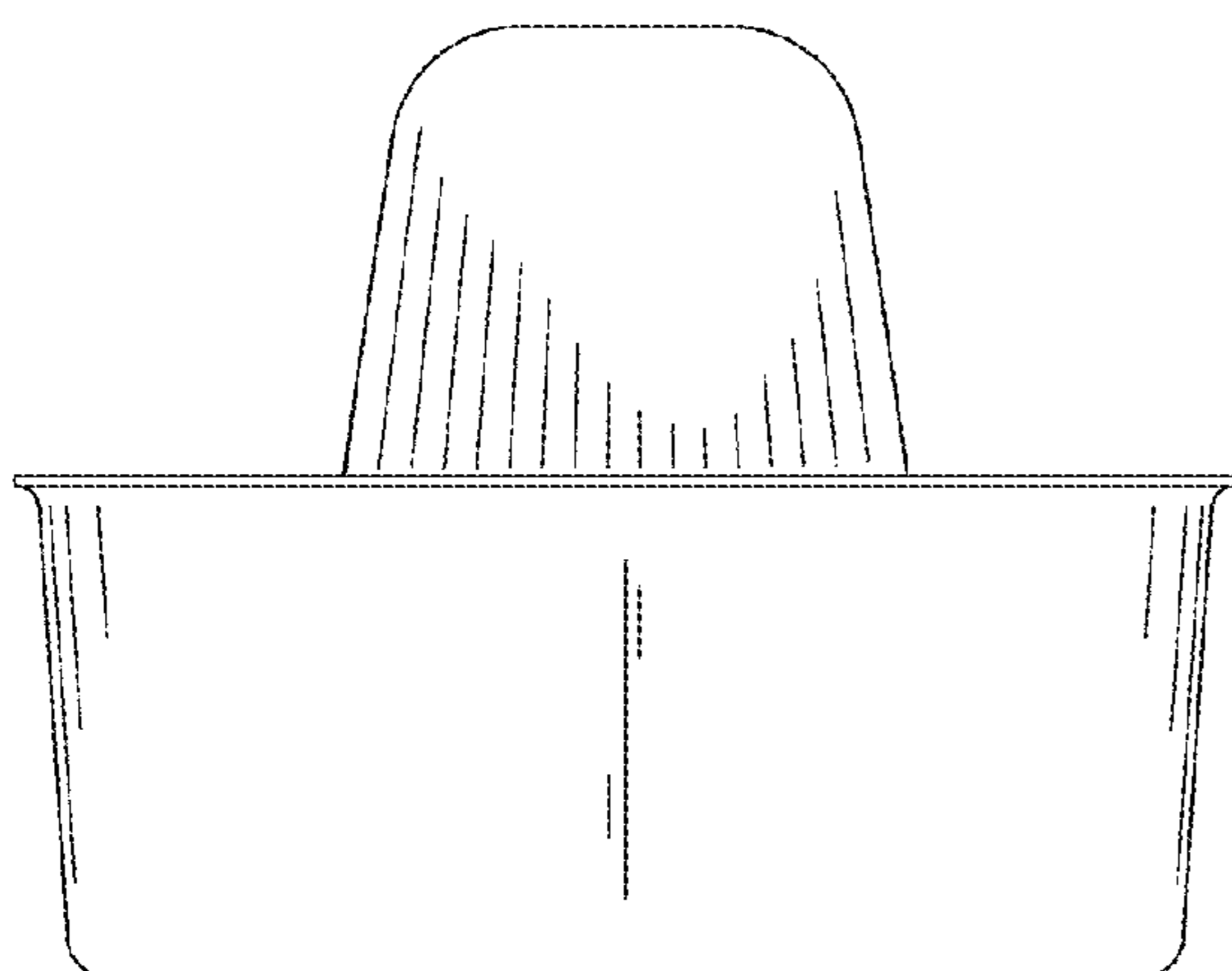

FIG. 3

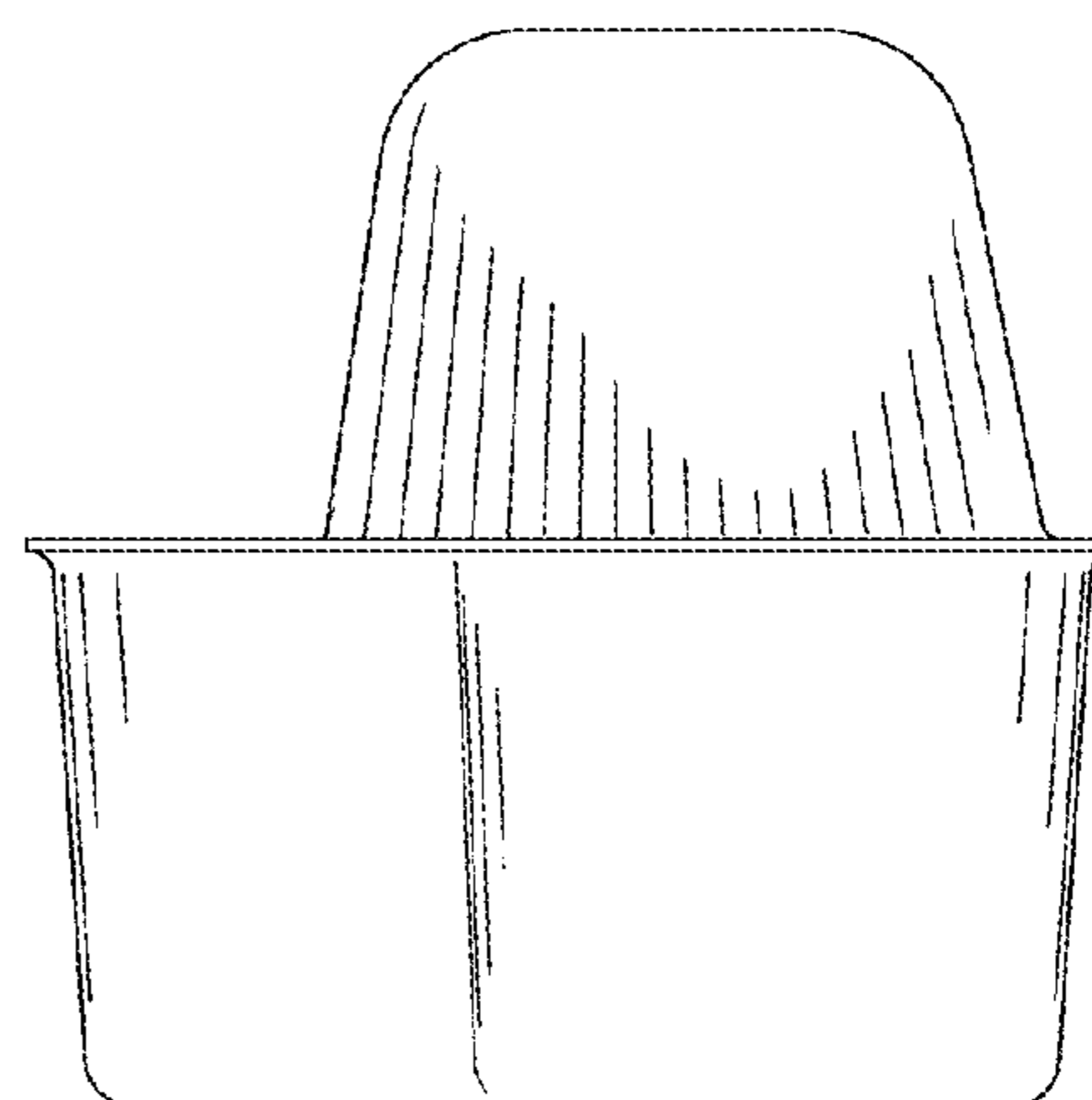

FIG. 4

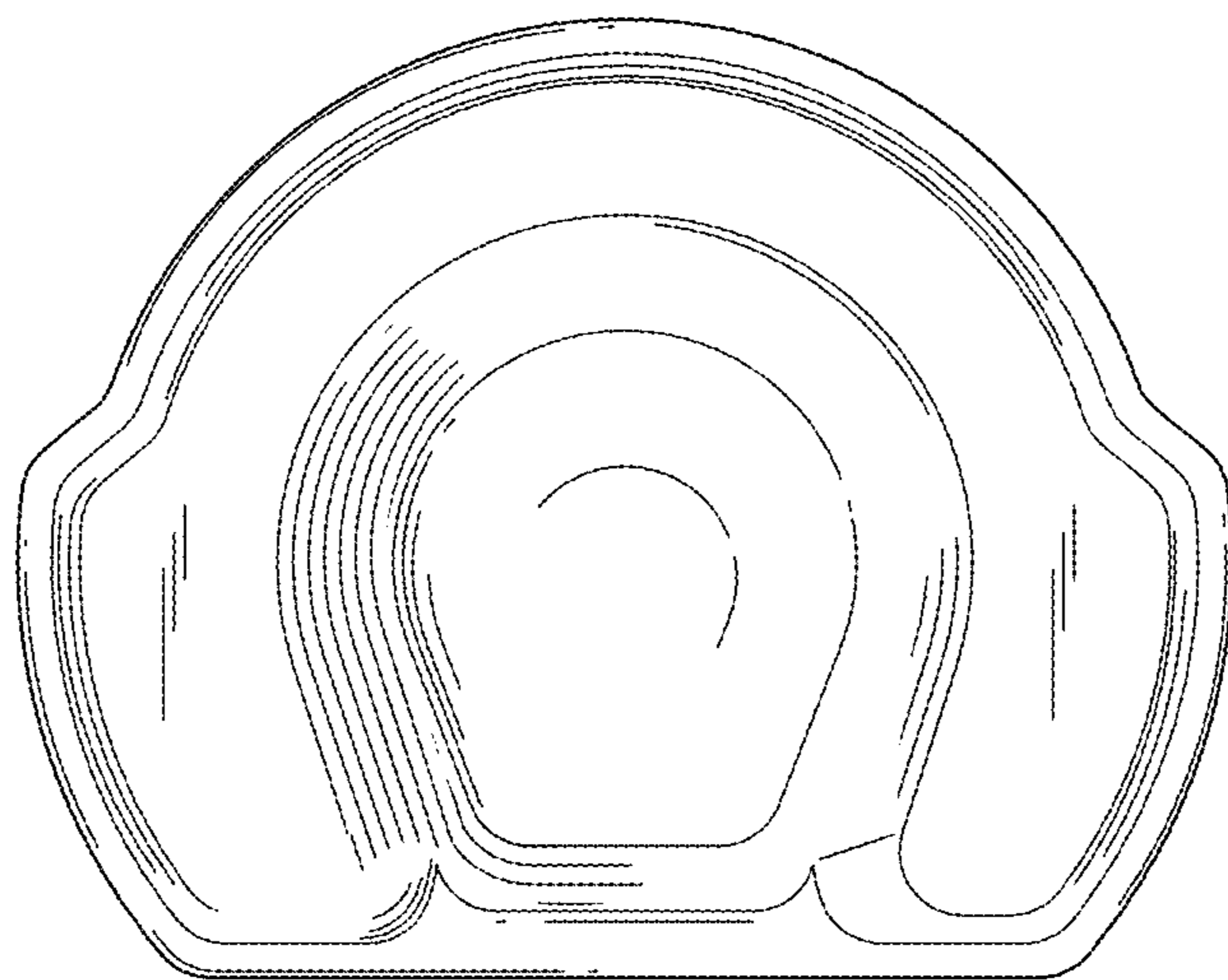

FIG. 5

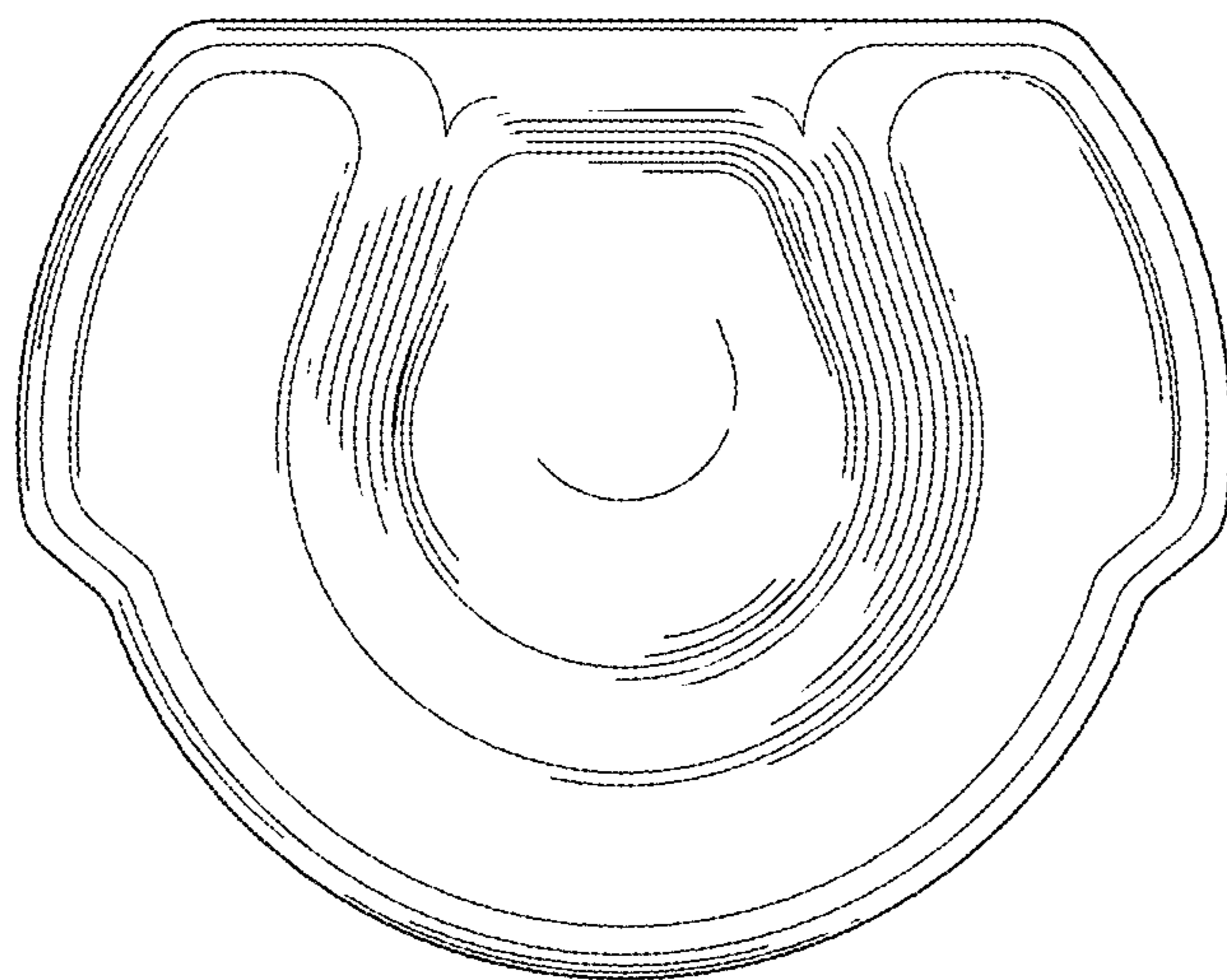

FIG. 6