



US00D759910S

(12) **United States Design Patent**  
**Chung et al.**

(10) **Patent No.:** **US D759,910 S**  
(45) **Date of Patent:** **\*\* Jun. 21, 2016**

(54) **WASHING MACHINE**  
(71) Applicant: **LG ELECTRONICS INC.**, Seoul (KR)  
(72) Inventors: **Wook Jun Chung**, Seoul (KR); **Ye Ji Um**, Seoul (KR); **Byeong Kook Kim**, Seoul (KR); **Jea Seok Seong**, Seoul (KR)  
(73) Assignee: **LG Electronics inc.**, Seoul (KR)

D620,211 S \* 7/2010 Shail ..... D32/25  
D629,168 S \* 12/2010 Park ..... D32/25  
8,215,136 B2 \* 7/2012 Kim ..... D06F 17/04  
68/11  
D665,544 S \* 8/2012 Jeon ..... D32/6  
D667,179 S \* 9/2012 Jeon ..... D32/6  
8,341,981 B2 \* 1/2013 Kim ..... D06F 39/125  
312/228  
D701,658 S \* 3/2014 Chung ..... D32/6  
D704,909 S \* 5/2014 Jeon ..... D32/25

(\*\*) Term: **14 Years**  
(21) Appl. No.: **29/525,820**  
(22) Filed: **May 4, 2015**

\* cited by examiner  
*Primary Examiner* — Susan Bennett Hattan  
*Assistant Examiner* — Rebecca Tsehaye  
(74) *Attorney, Agent, or Firm* — Morgan, Lewis & Bockius LLP

(30) **Foreign Application Priority Data**  
Dec. 9, 2014 (KR) ..... 30-2014-0060019  
(51) **LOC (10) Cl.** ..... **15-05**  
(52) **U.S. Cl.**  
USPC ..... **D32/6**  
(58) **Field of Classification Search**  
USPC ..... D32/1, 5, 6, 8, 10, 11, 25, 29; 312/228  
CPC ..... D06F 17/04; D06F 37/02; D06F 37/08;  
D06F 37/12; D06F 37/145; D06F 39/00;  
D06F 39/08; D06F 31/00; B08B 3/12  
See application file for complete search history.

(57) **CLAIM**  
We claim the ornamental design for a washing machine, as shown and described.

(56) **References Cited**  
U.S. PATENT DOCUMENTS  
D521,702 S \* 5/2006 No ..... D32/25  
D549,408 S \* 8/2007 Lee ..... D32/25  
7,628,043 B2 \* 12/2009 Sunshine ..... D06F 95/00  
68/20

**DESCRIPTION**  
FIG. 1 is a perspective view of a washing machine showing our new design;  
FIG. 2 is a front elevation view thereof;  
FIG. 3 is a rear elevation view thereof;  
FIG. 4 is a left-side elevation view thereof;  
FIG. 5 is a right-side elevation view thereof;  
FIG. 6 is a top plan view thereof;  
FIG. 7 is a bottom plan view thereof; and,  
FIG. 8 is a perspective view showing an illustration of use thereof.  
The broken lines in the drawing figures are included for the purpose of illustrating environment and form no part of the claimed design.

**1 Claim, 7 Drawing Sheets**

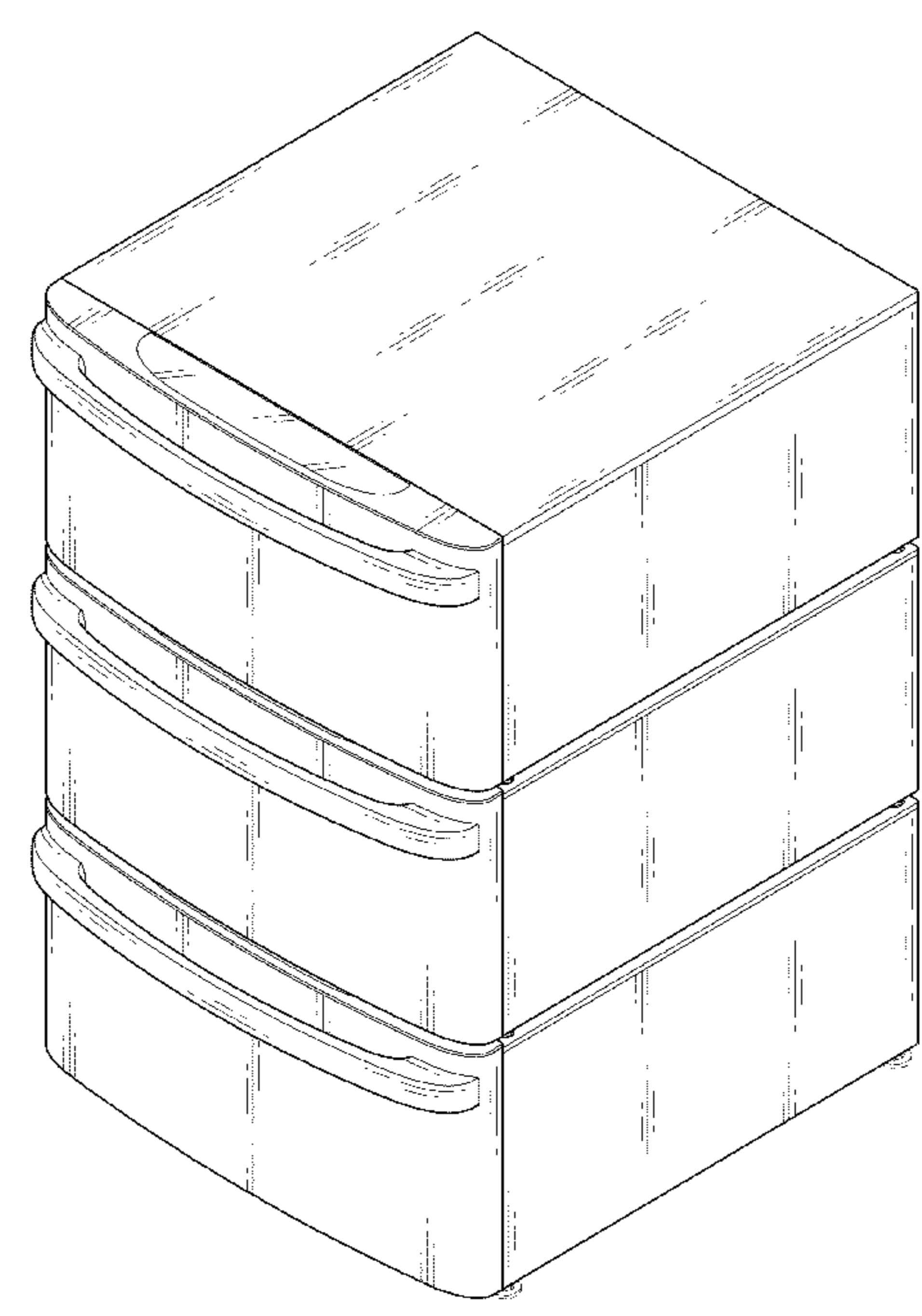

FIG. 1

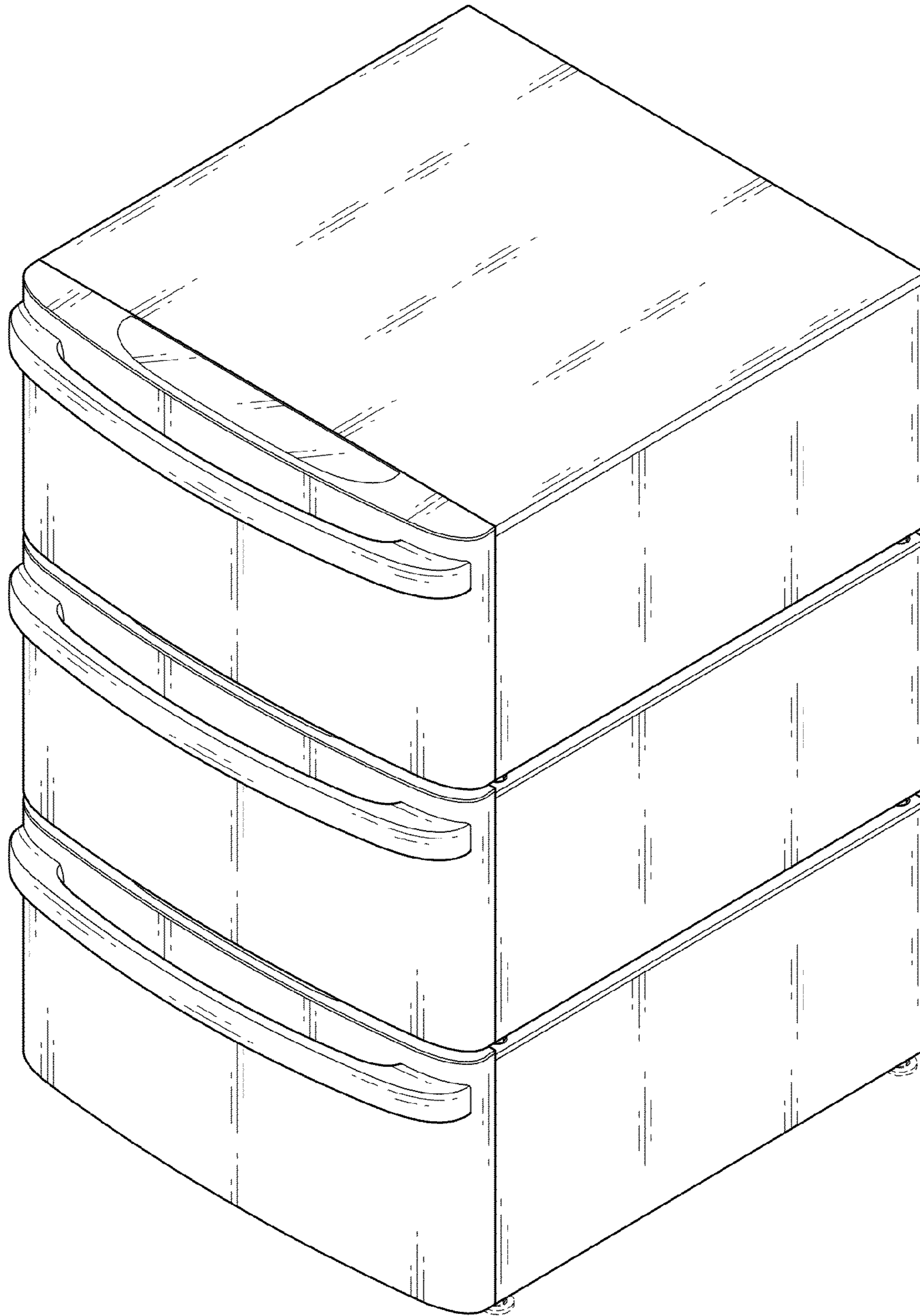

FIG. 2

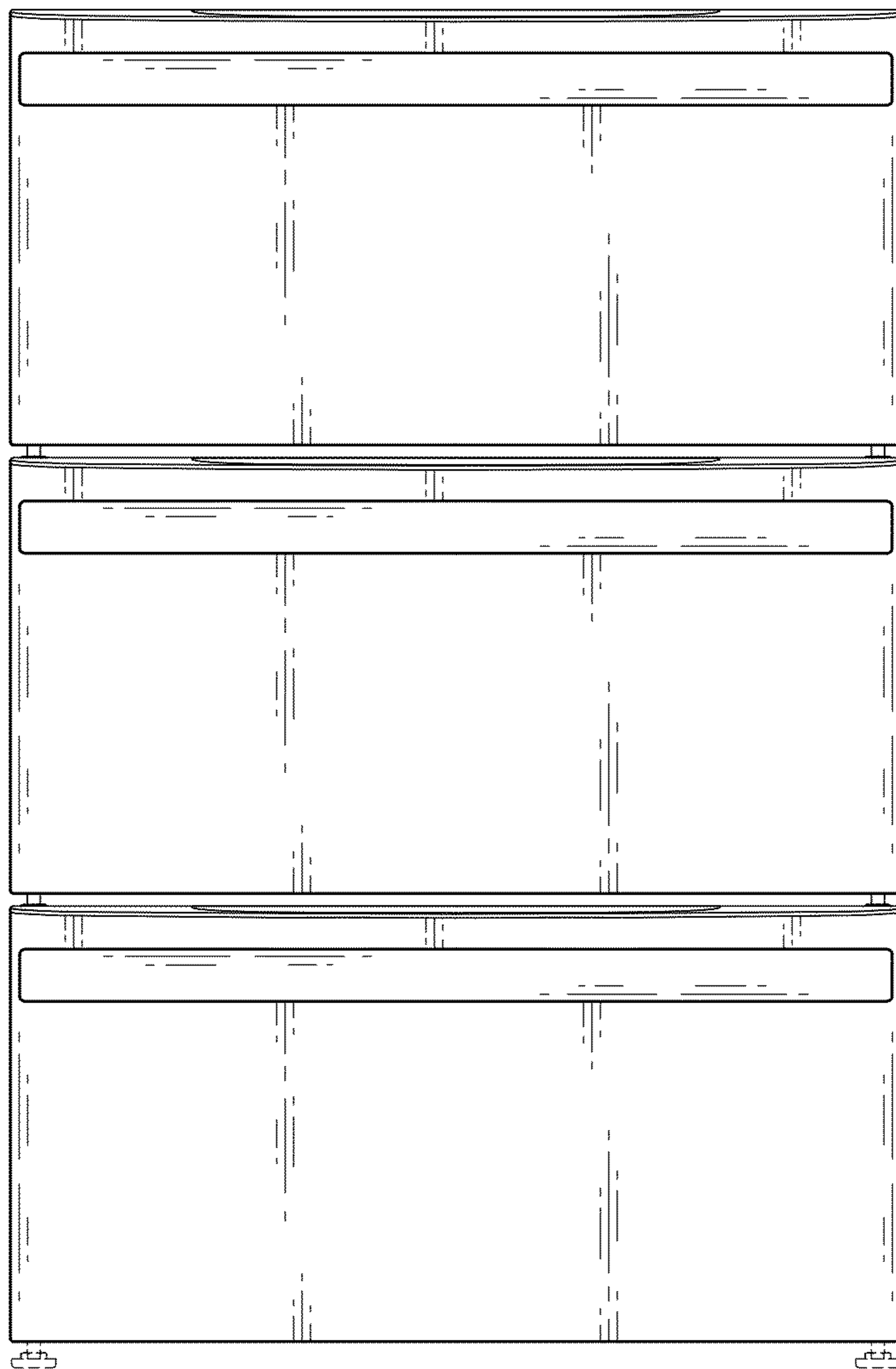

FIG. 3

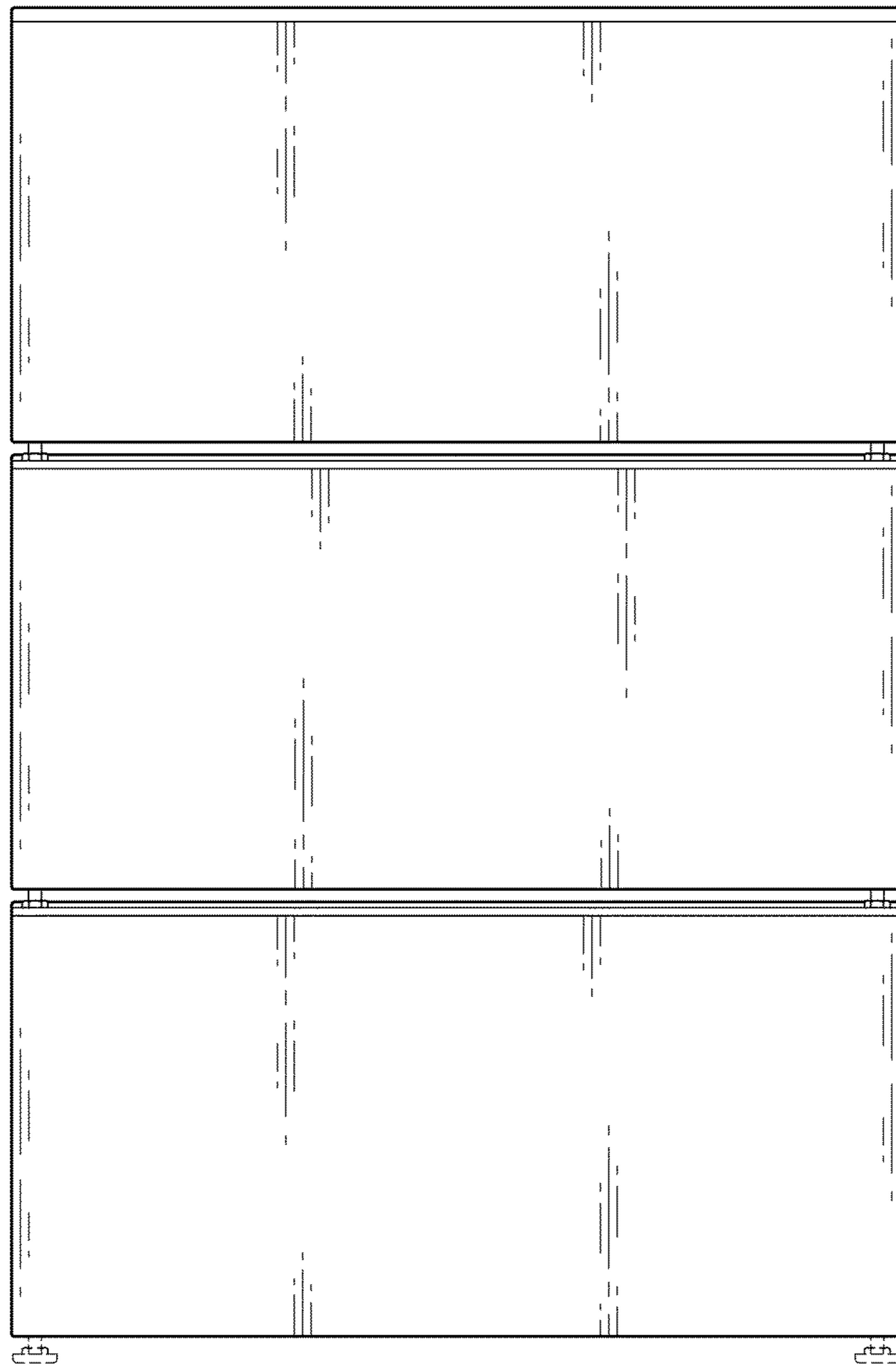

FIG. 4

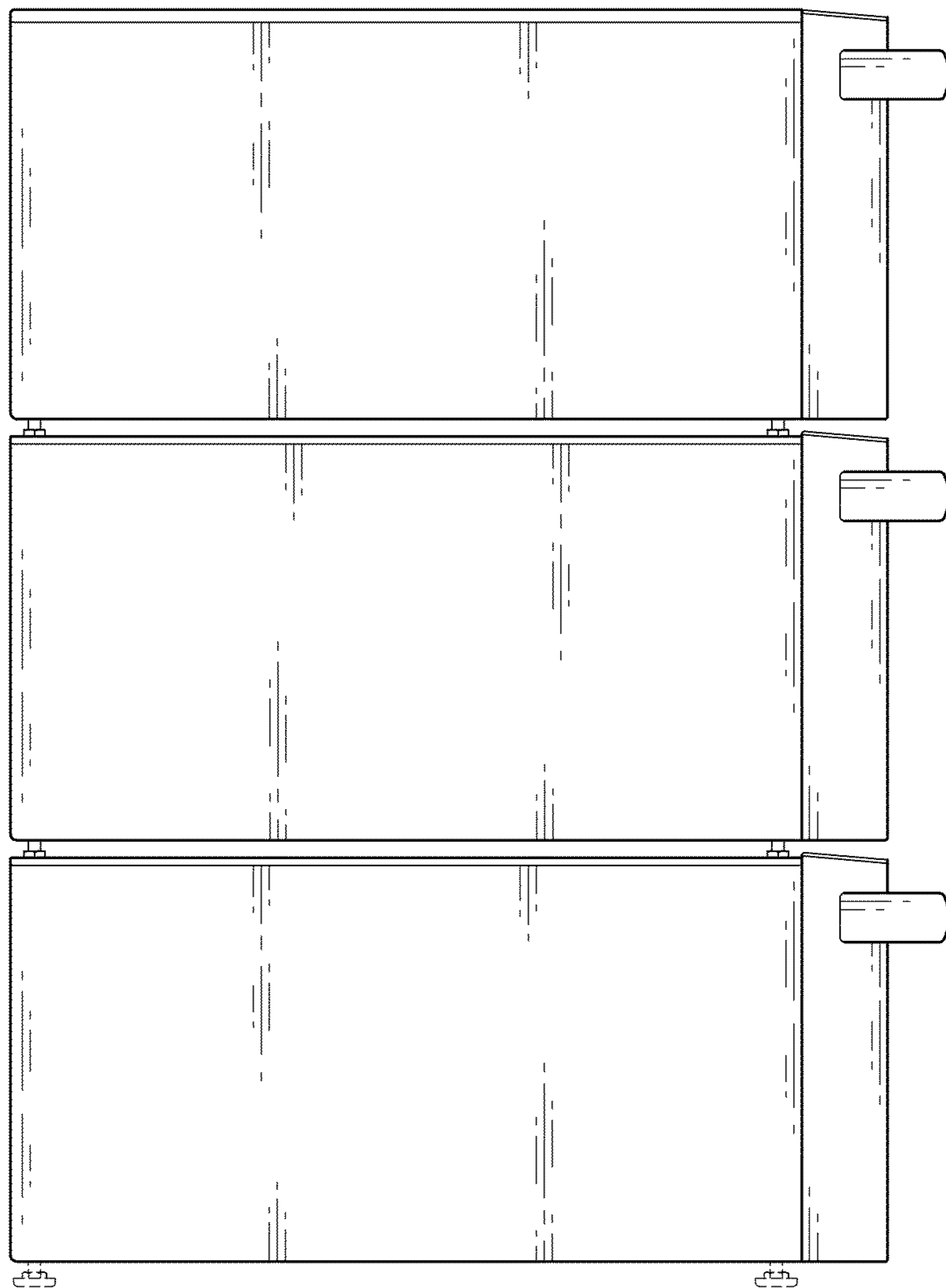

FIG. 5

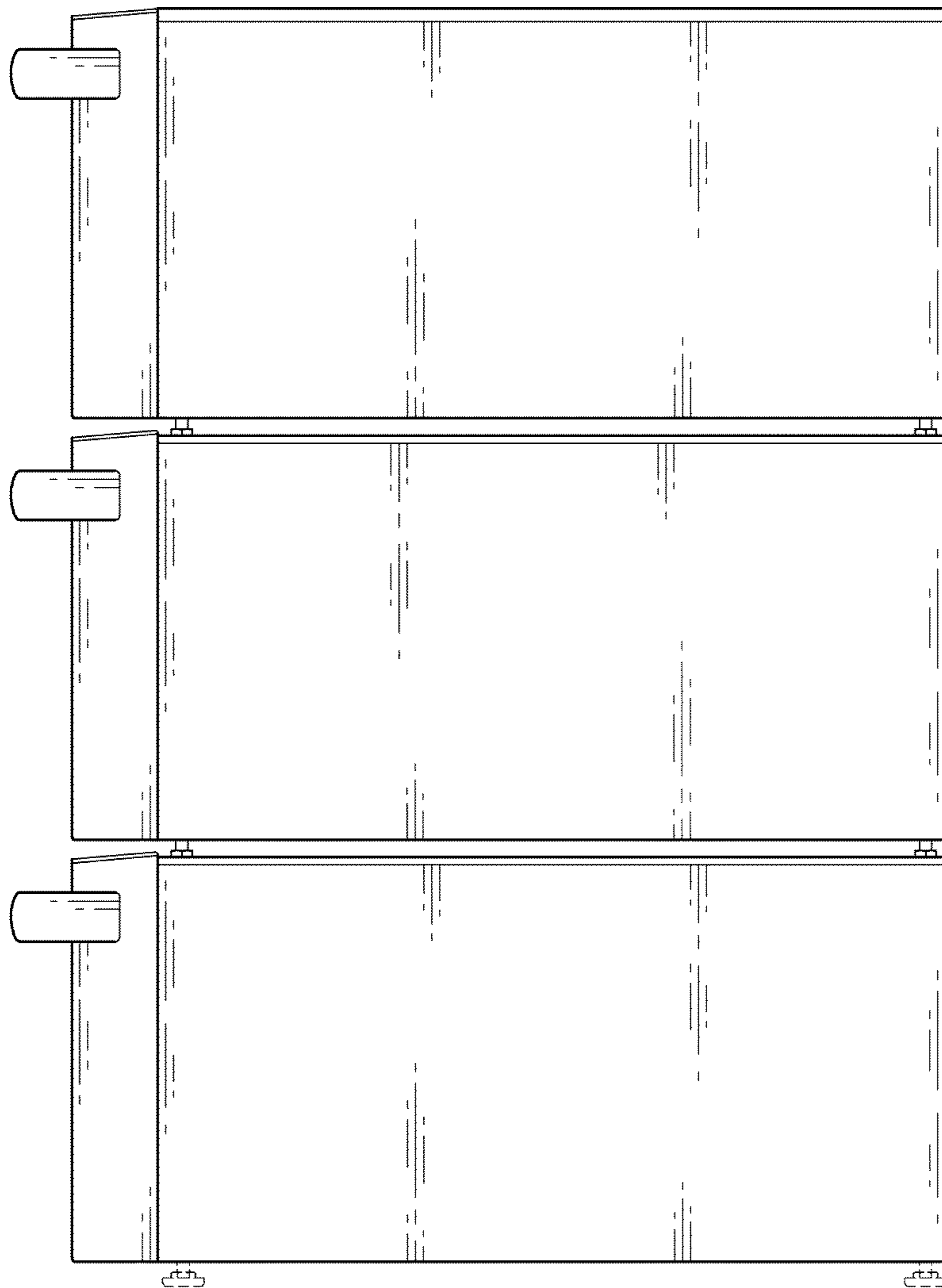

FIG. 6

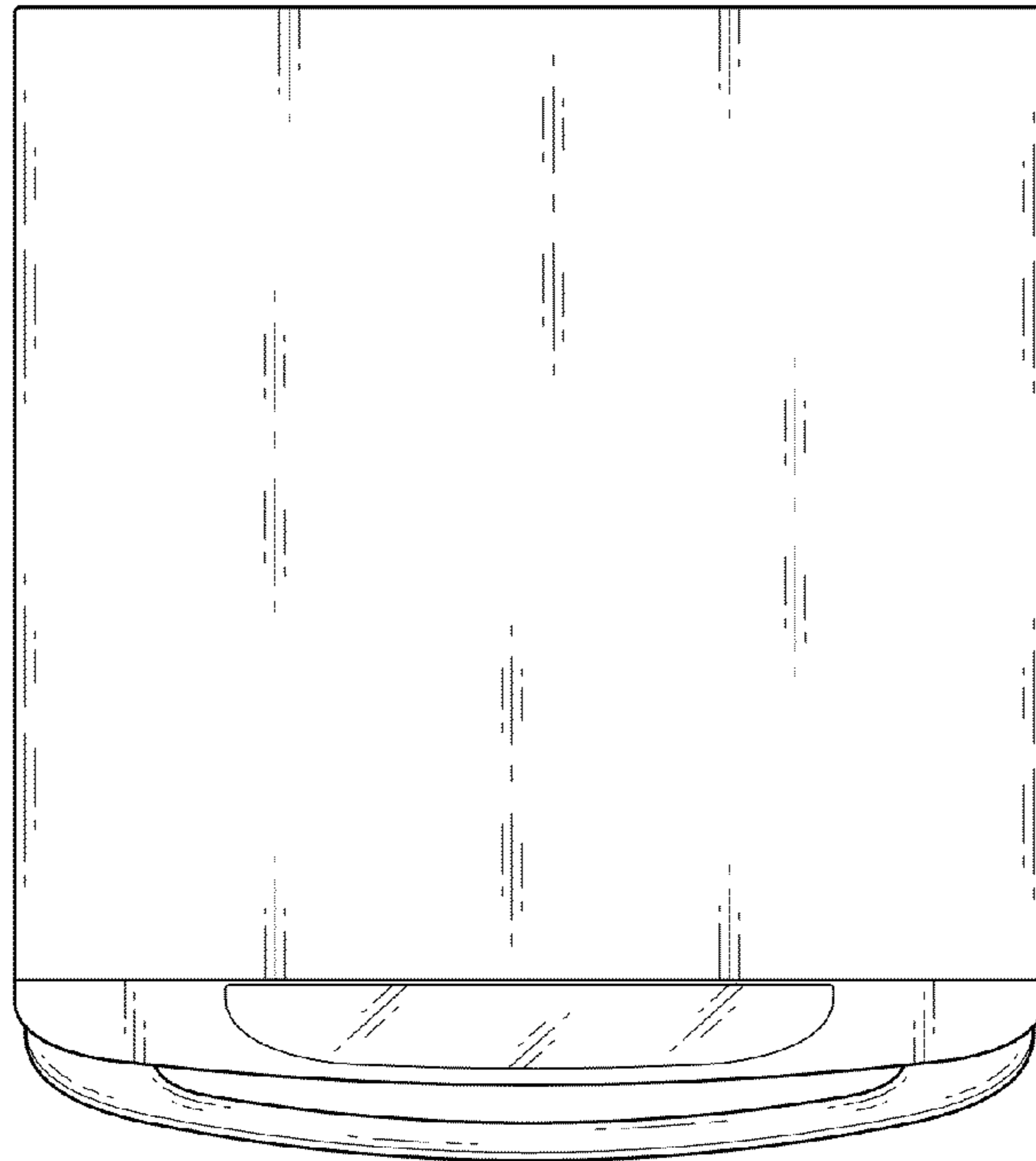

FIG. 7

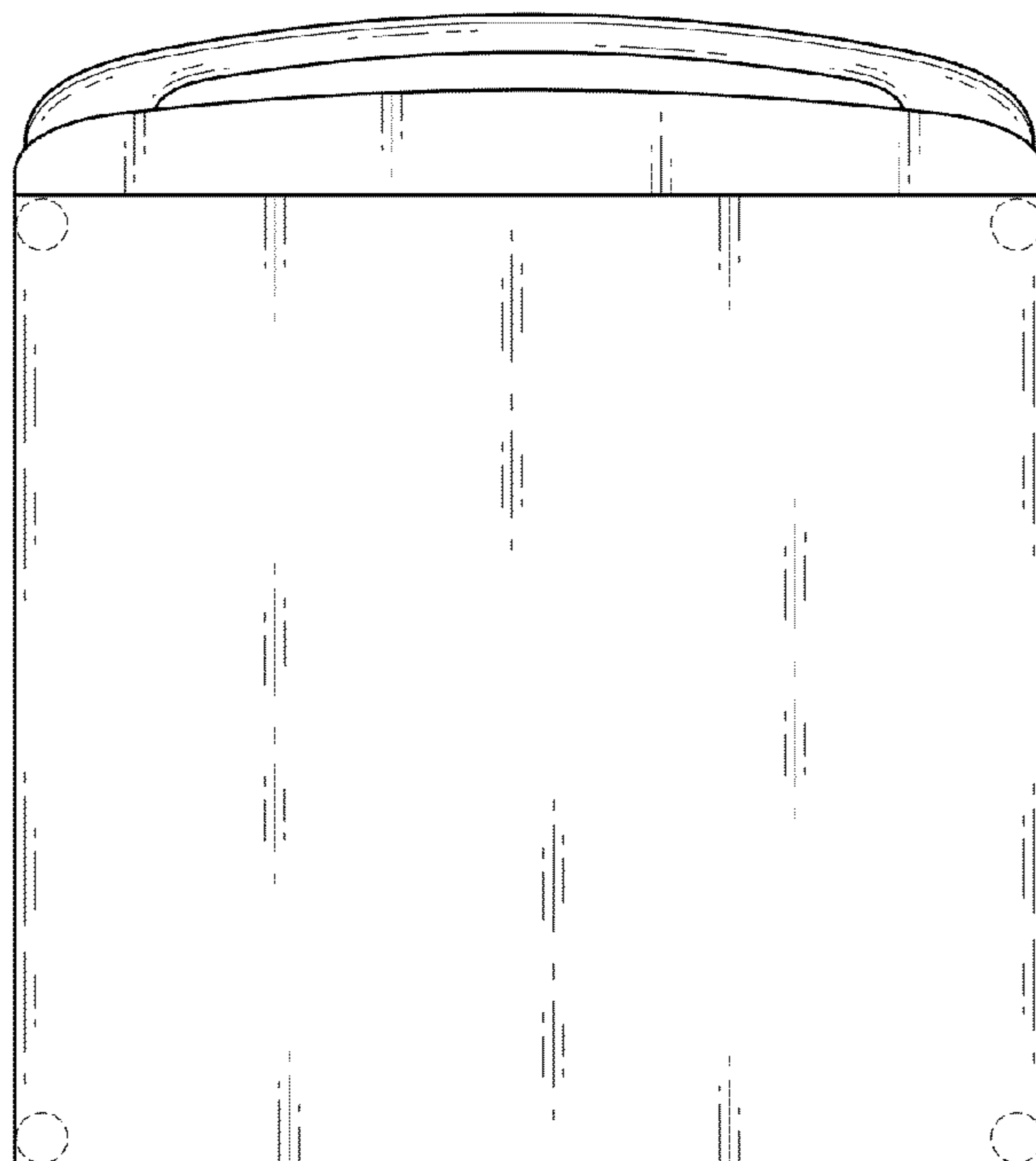

FIG. 8

