



US00D759856S

(12) **United States Design Patent**
Yang

(10) **Patent No.:** **US D759,856 S**
(45) **Date of Patent:** **** Jun. 21, 2016**

(54) **PORTION OF A LIGHT BULB**

Primary Examiner — Marcus Jackson

(71) Applicant: **Sim Lighting Design Company Limited**, Wanchai (HK)

(74) *Attorney, Agent, or Firm* — Wang Law Firm, Inc.

(72) Inventor: **Zhiqiang Yang**, WanChai (HK)

(57) **CLAIM**

(73) Assignee: **Sim Lighting Design Company Limited**, Wanchai (HK)

The ornamental design for a portion of a light bulb, as shown and described.

(**) Term: **14 Years**

DESCRIPTION

(21) Appl. No.: **29/524,003**

(22) Filed: **Apr. 15, 2015**

(30) **Foreign Application Priority Data**

Oct. 16, 2014 (CN) 2014 3 0392357

(51) **LOC (10) Cl.** **26-04**

(52) **U.S. Cl.**
USPC **D26/2**

(58) **Field of Classification Search**

USPC D26/1-4; 313/313, 315, 316, 317, 318,
313/493; 315/52, 53, 56, 57, 58

CPC H01J 5/00; H01J 5/48; H01J 5/50;
H01J 19/54; F21V 5/00

See application file for complete search history.

(56) **References Cited**

U.S. PATENT DOCUMENTS

D410,554 S * 6/1999 Guyton D26/2
D422,099 S * 3/2000 Kracke D26/2
D549,360 S * 8/2007 An D26/2
D550,864 S * 9/2007 Hernandez, Jr. D26/2
D689,215 S * 9/2013 Xue D26/2

* cited by examiner

FIG. 1 is a left view showing a first embodiment of my new design;
FIG. 2 is a front view thereof;
FIG. 3 is a rear view thereof;
FIG. 4 is a bottom view thereof;
FIG. 5 is a right view thereof;
FIG. 6 is a left perspective view thereof;
FIG. 7 is a left view showing a second embodiment of my new design;
FIG. 8 is a front view thereof;
FIG. 9 is a rear view thereof;
FIG. 10 is a bottom view thereof;
FIG. 11 is a right view thereof;
FIG. 12 is a left perspective view thereof;
FIG. 13 is a left view showing a third embodiment of my new design;
FIG. 14 is a front view thereof;
FIG. 15 is a rear view thereof;
FIG. 16 is a bottom view thereof;
FIG. 17 is a right view thereof; and,
FIG. 18 is a left perspective view thereof.

The broken lines shown on the drawings are for the purpose of illustration and form no part of the claimed design.

1 Claim, 9 Drawing Sheets

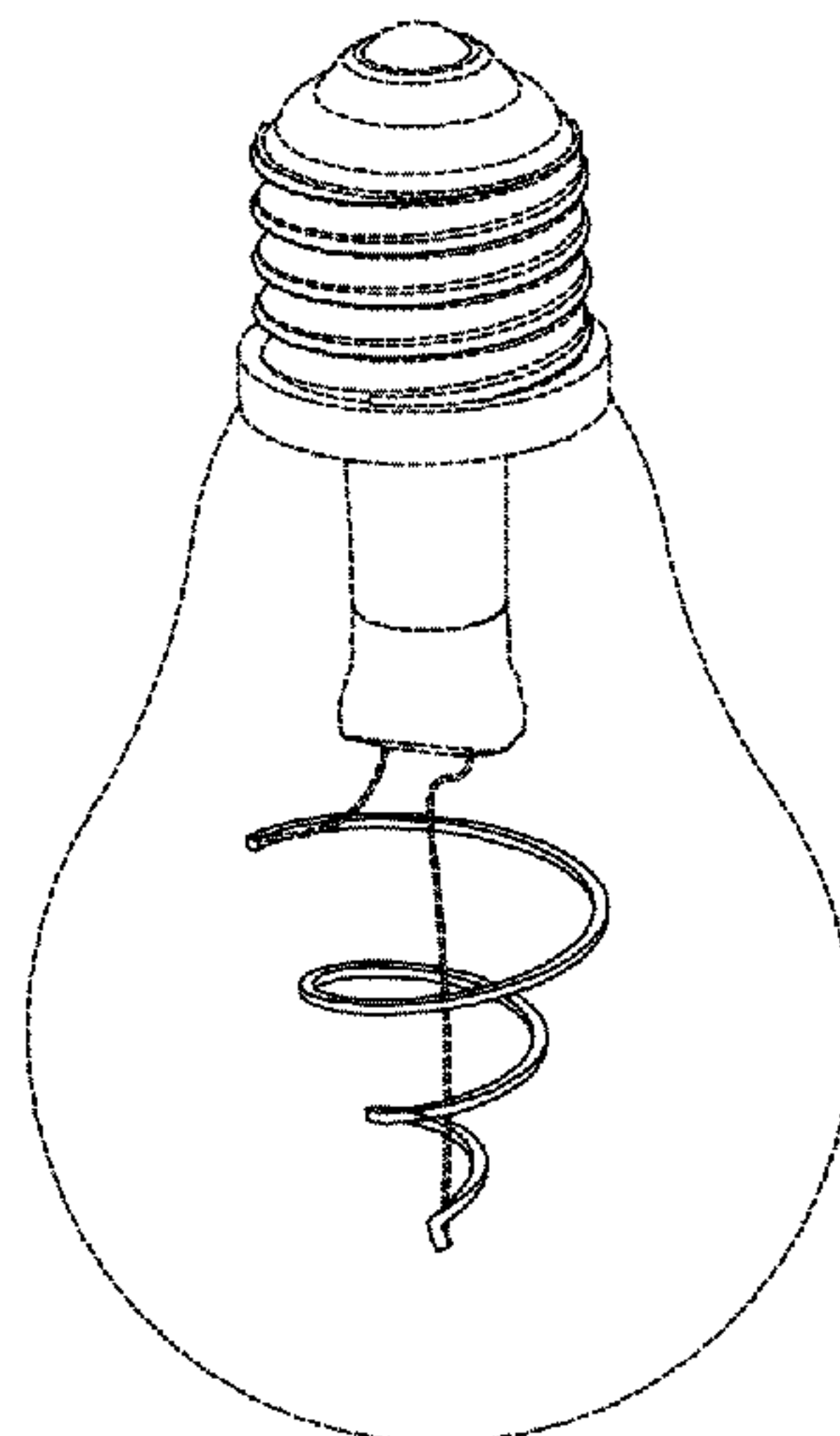

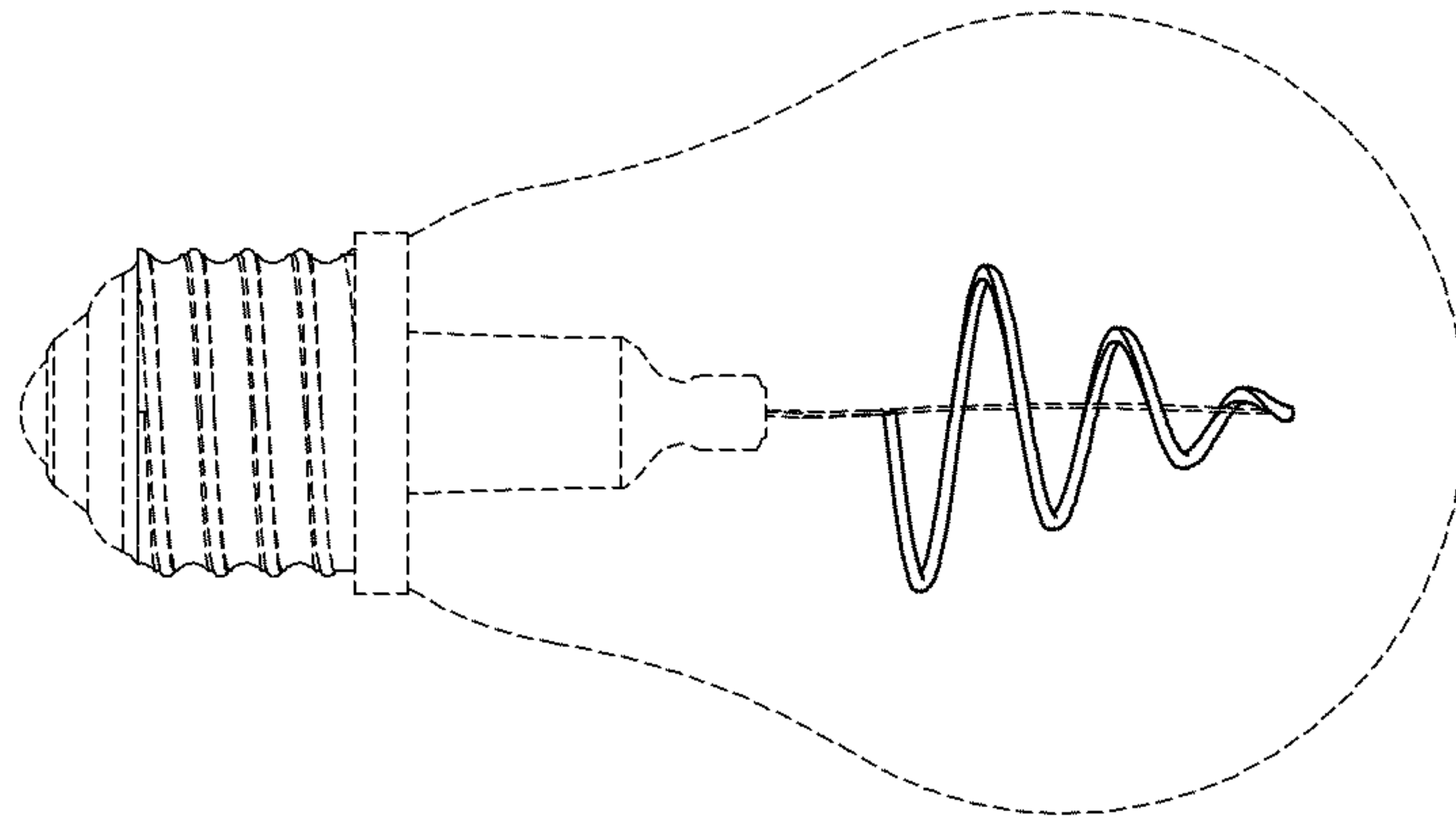

FIG. 2

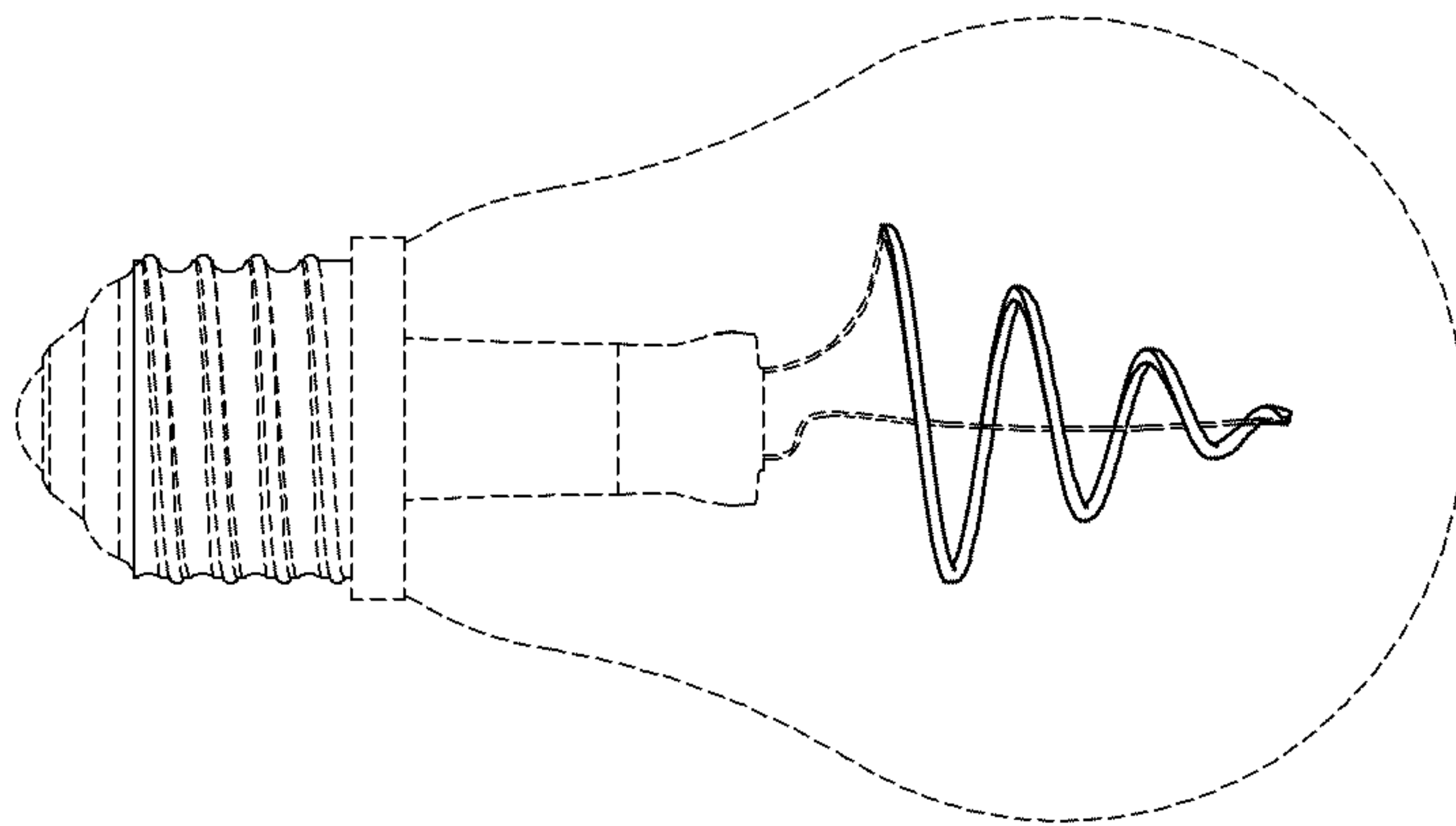

FIG. 1

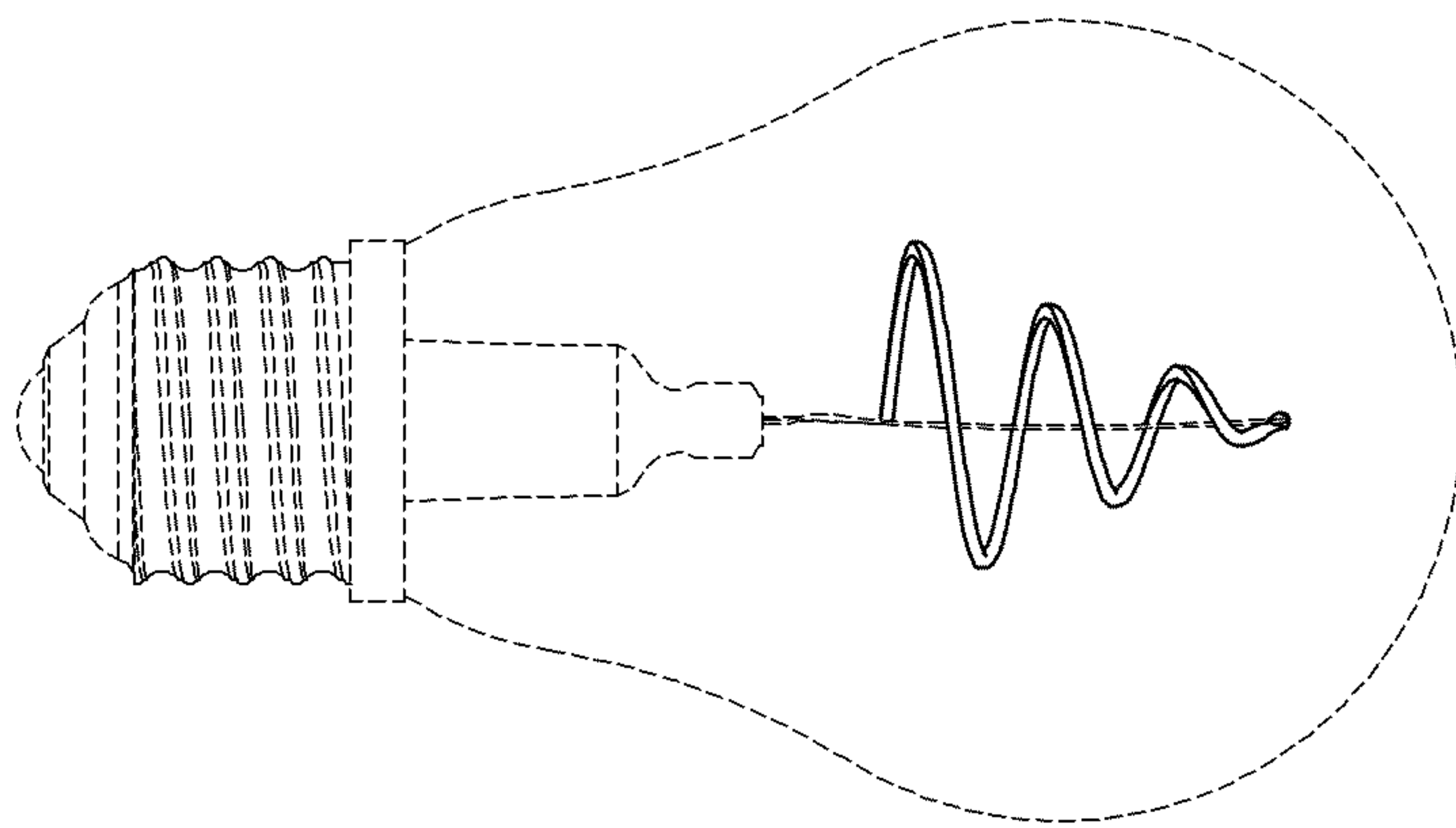

FIG. 3

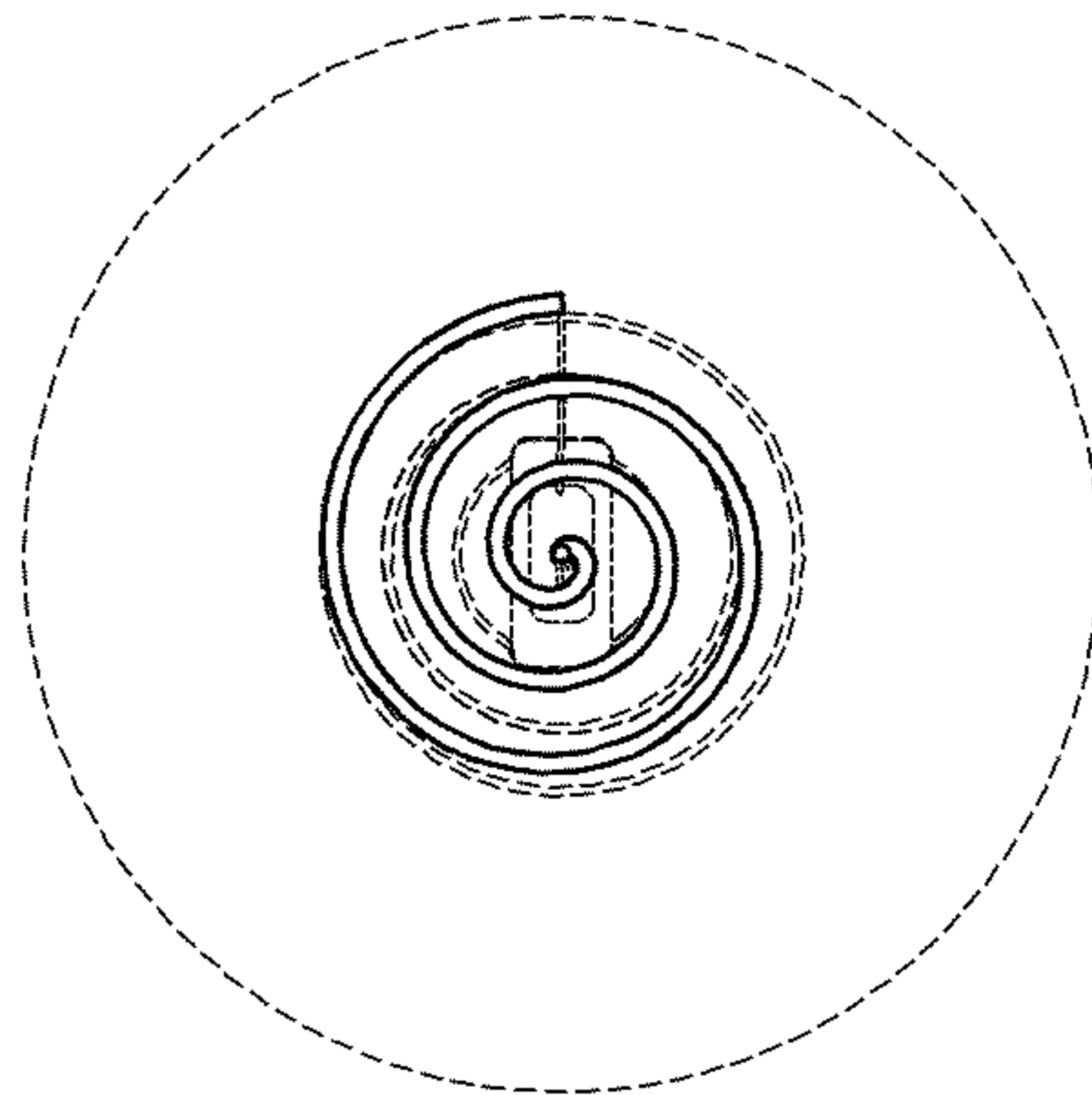

FIG. 4

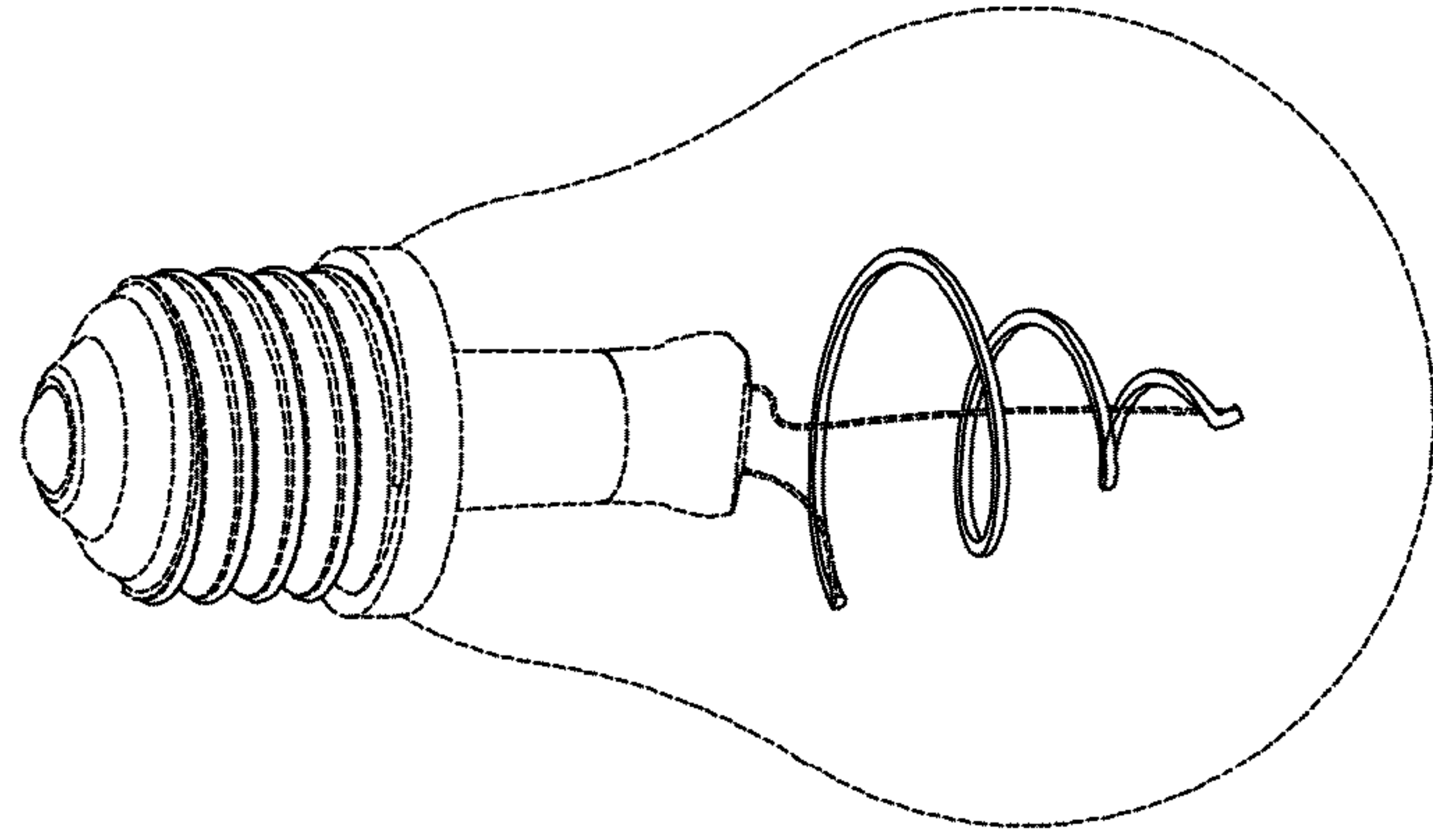

FIG. 6

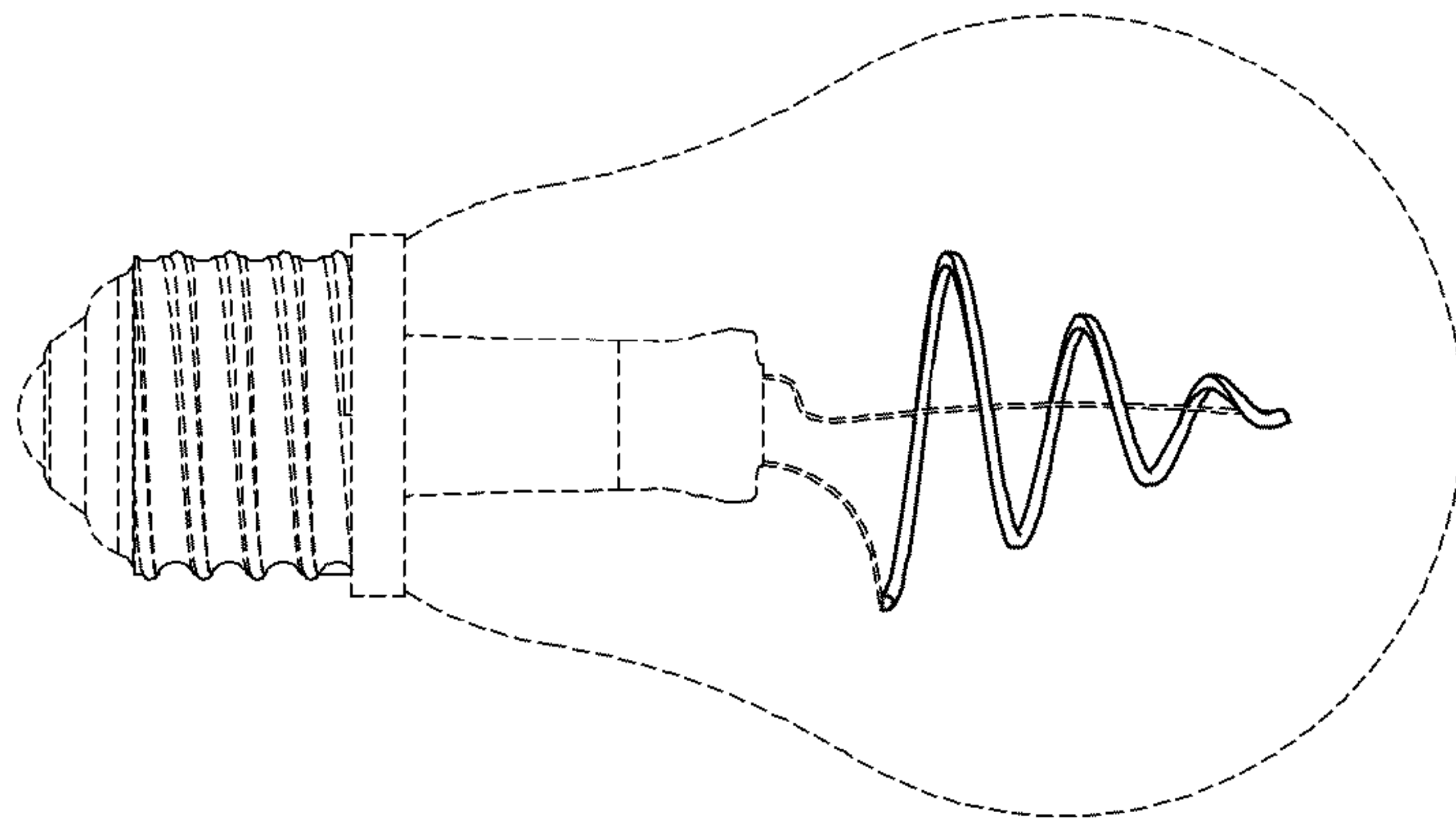

FIG. 5

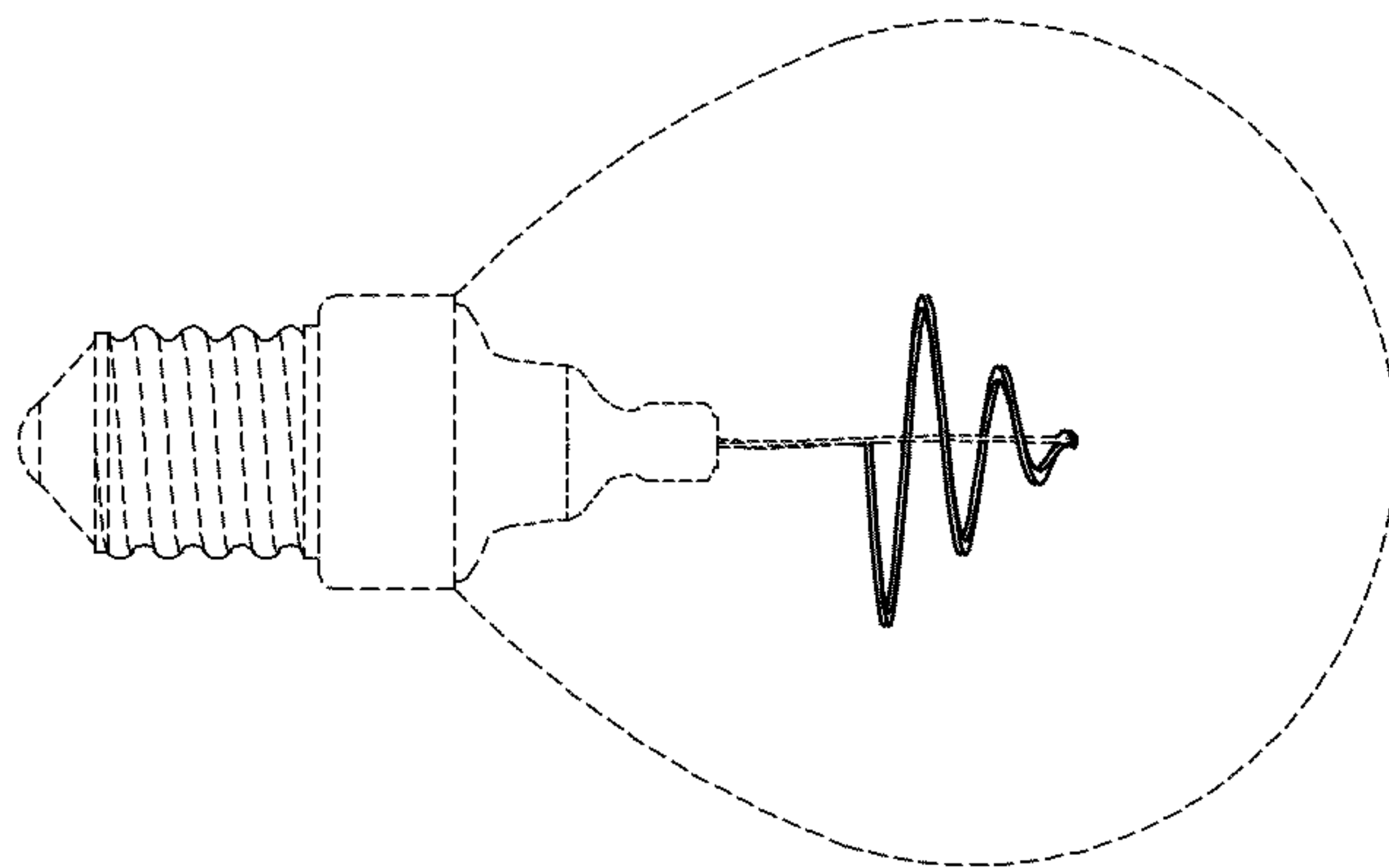

FIG. 8

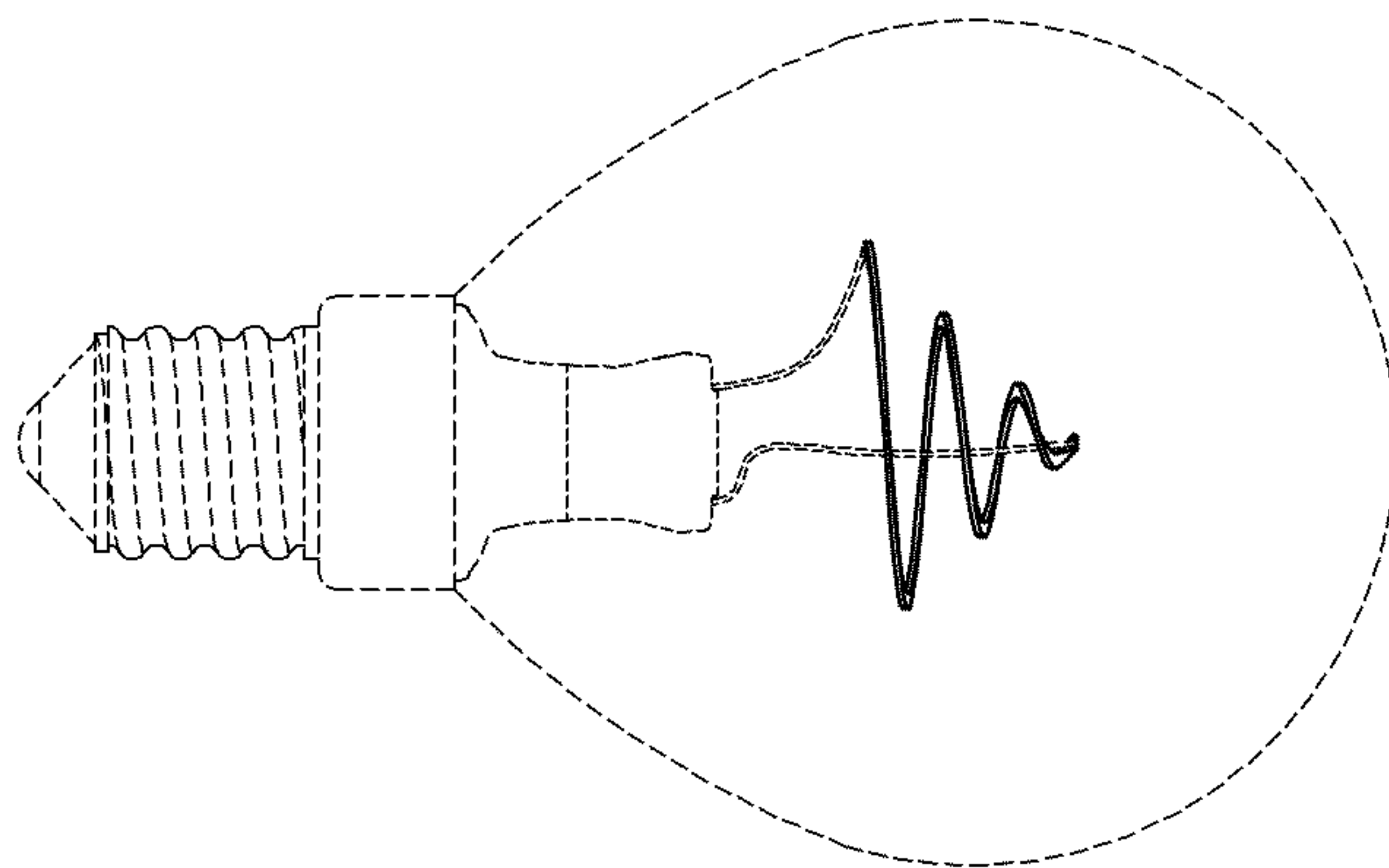

FIG. 7

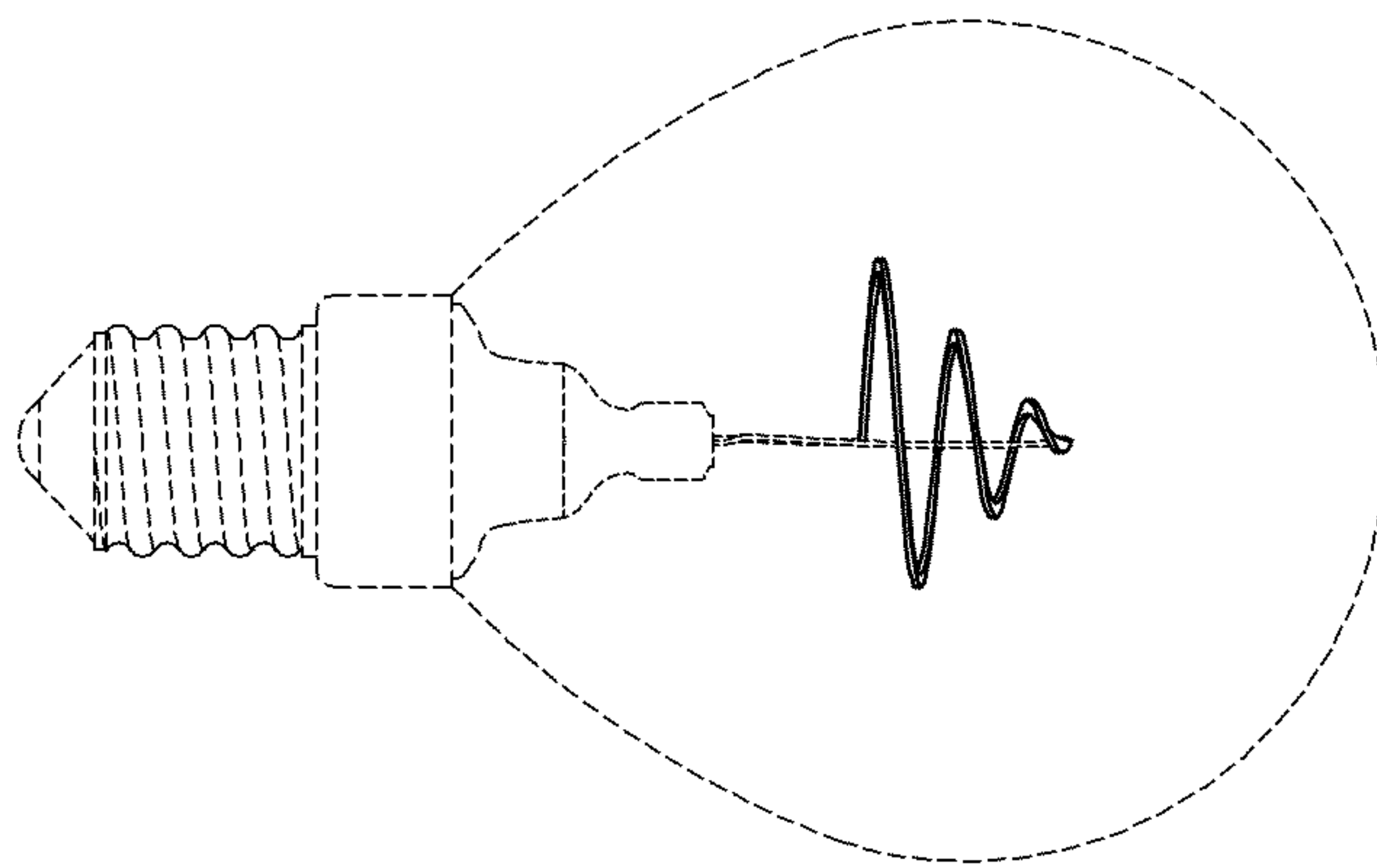

FIG. 9

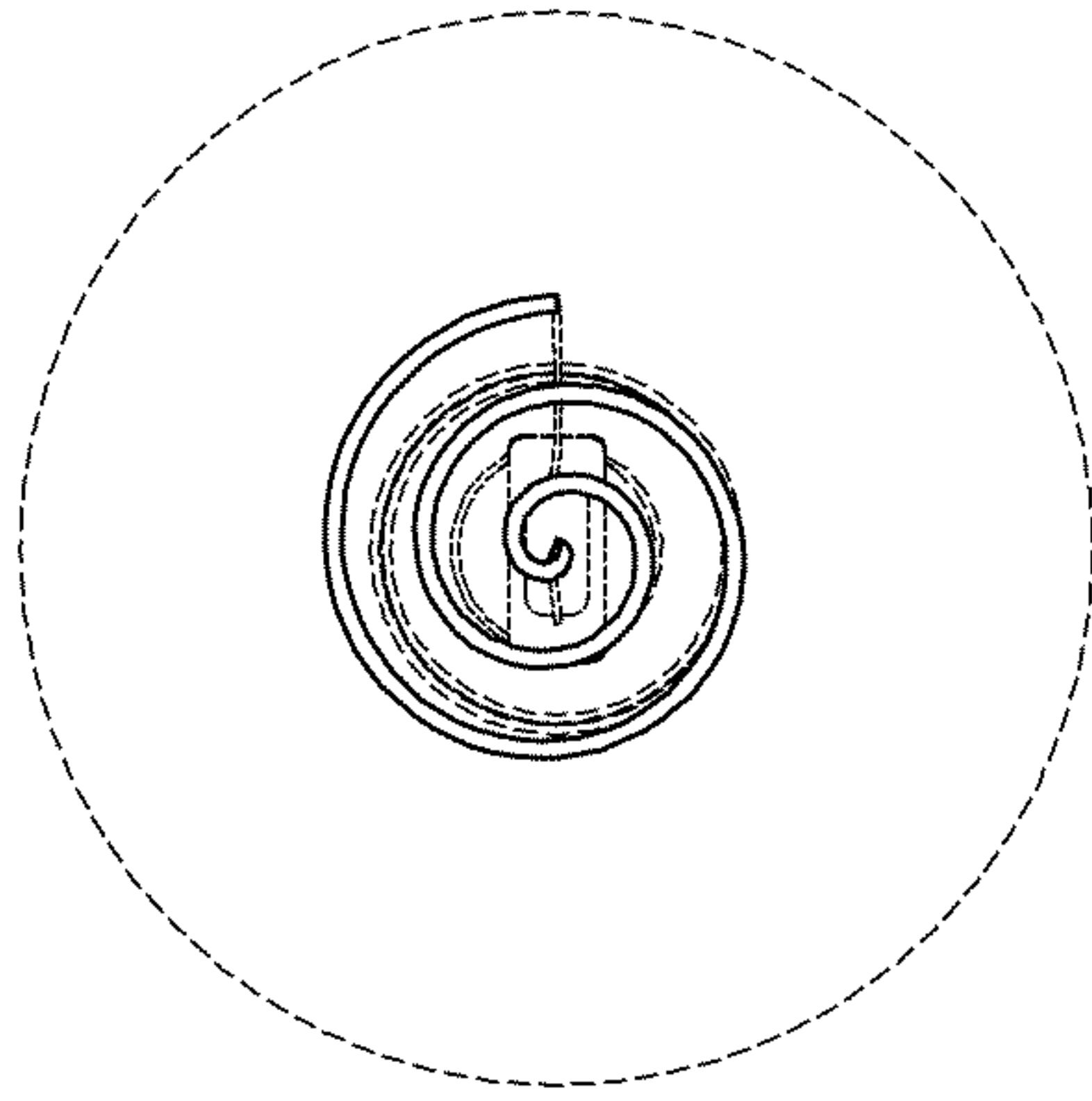

FIG. 10

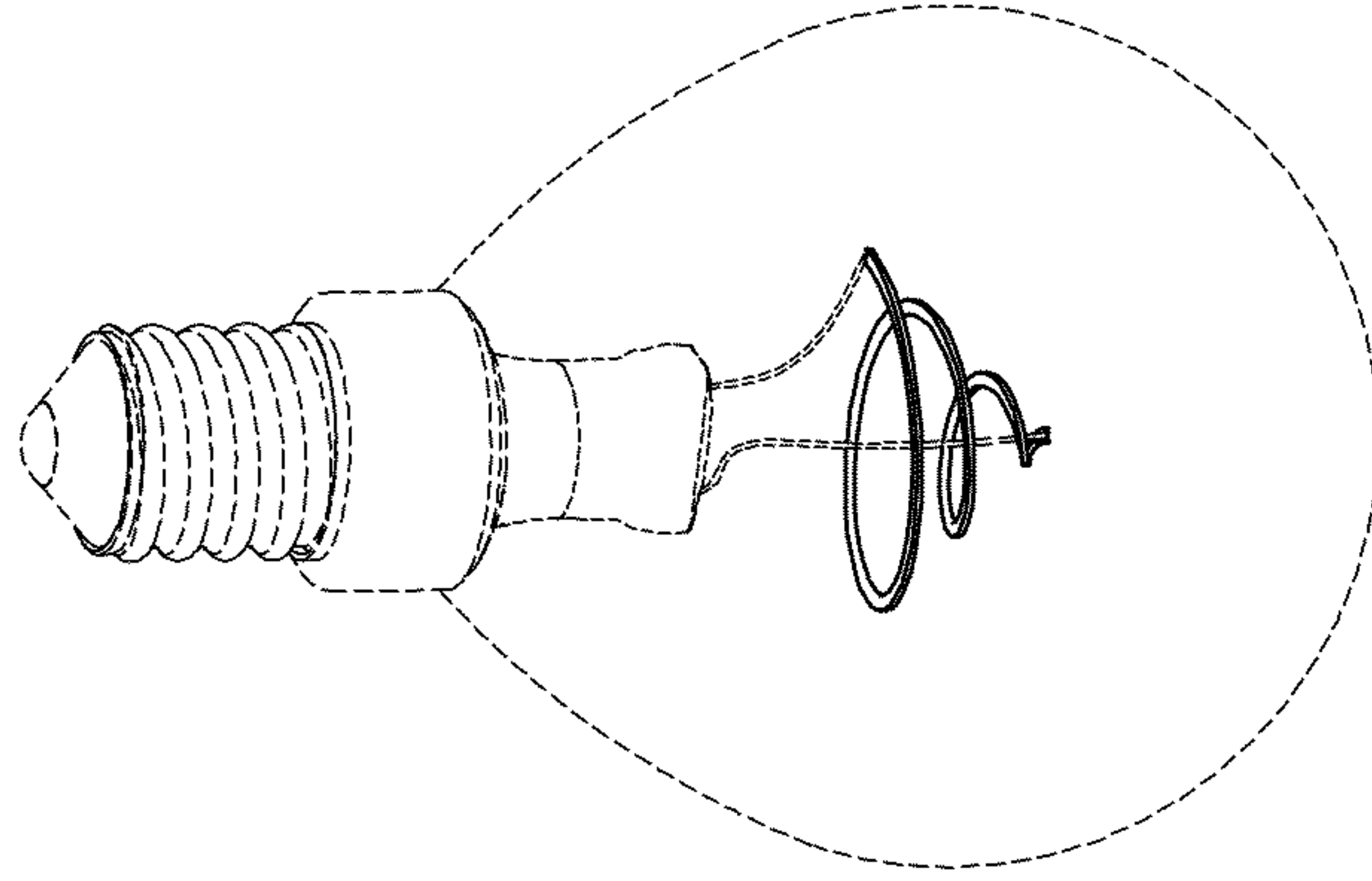

FIG. 11

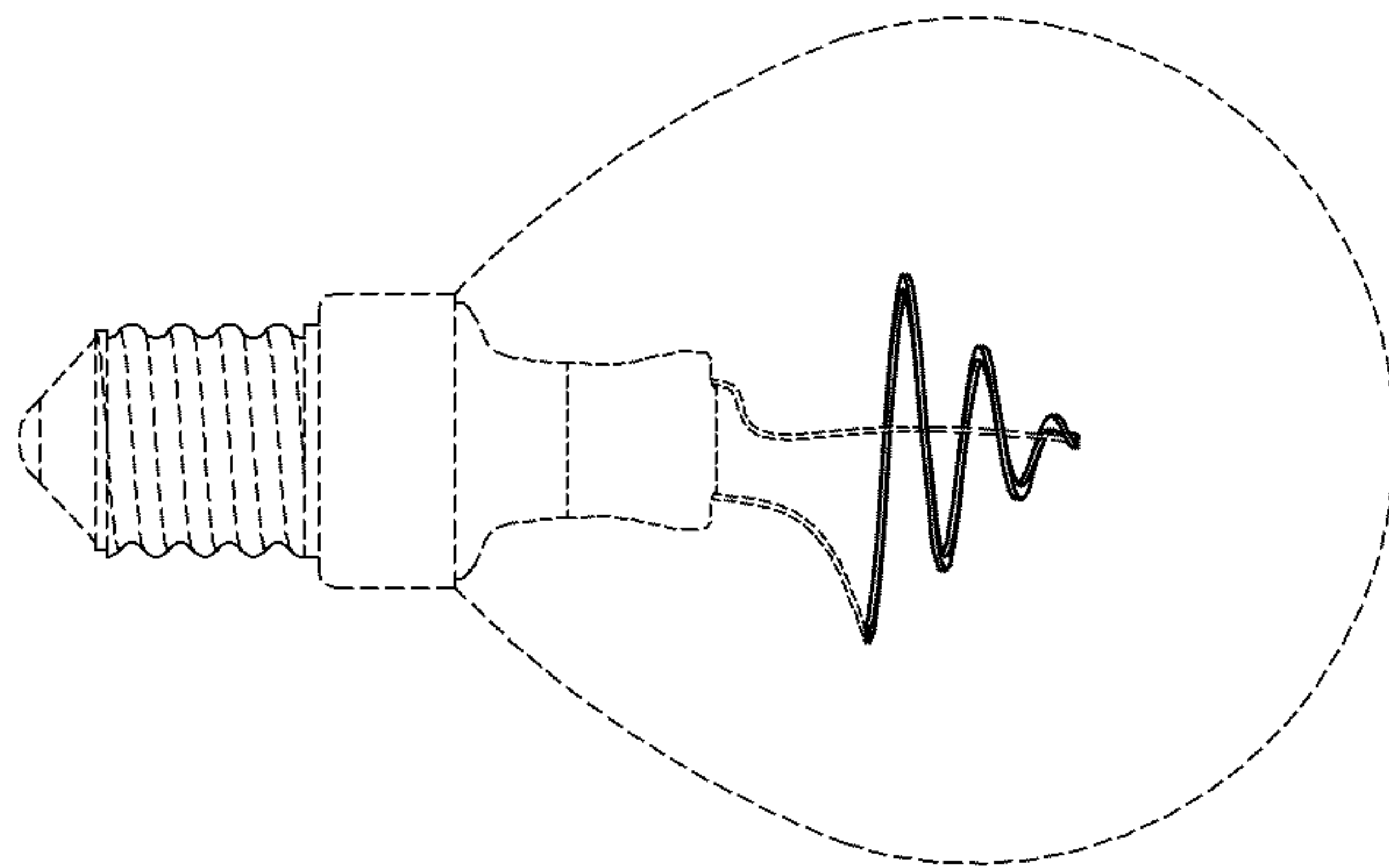

FIG. 12

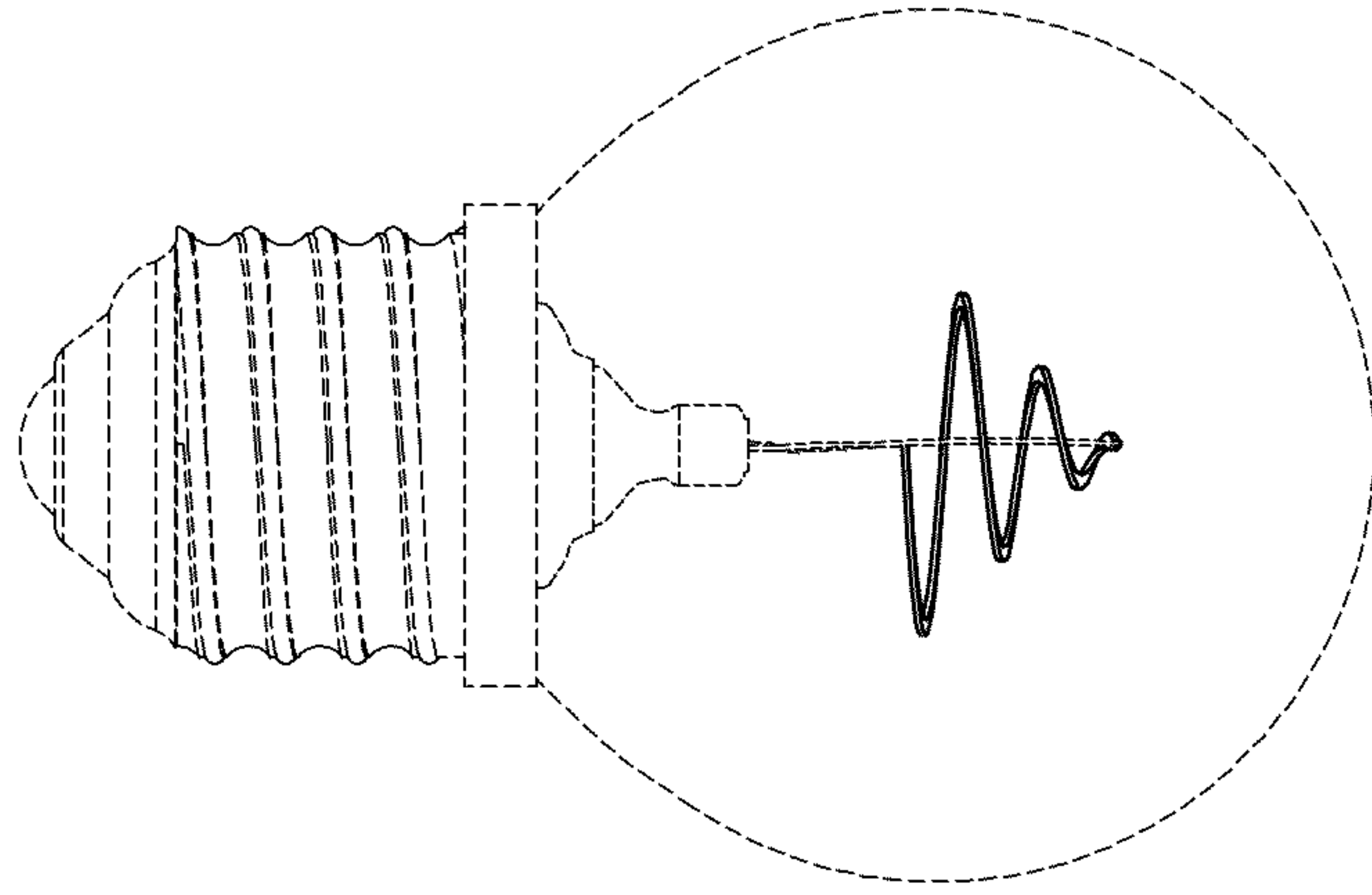

FIG. 14

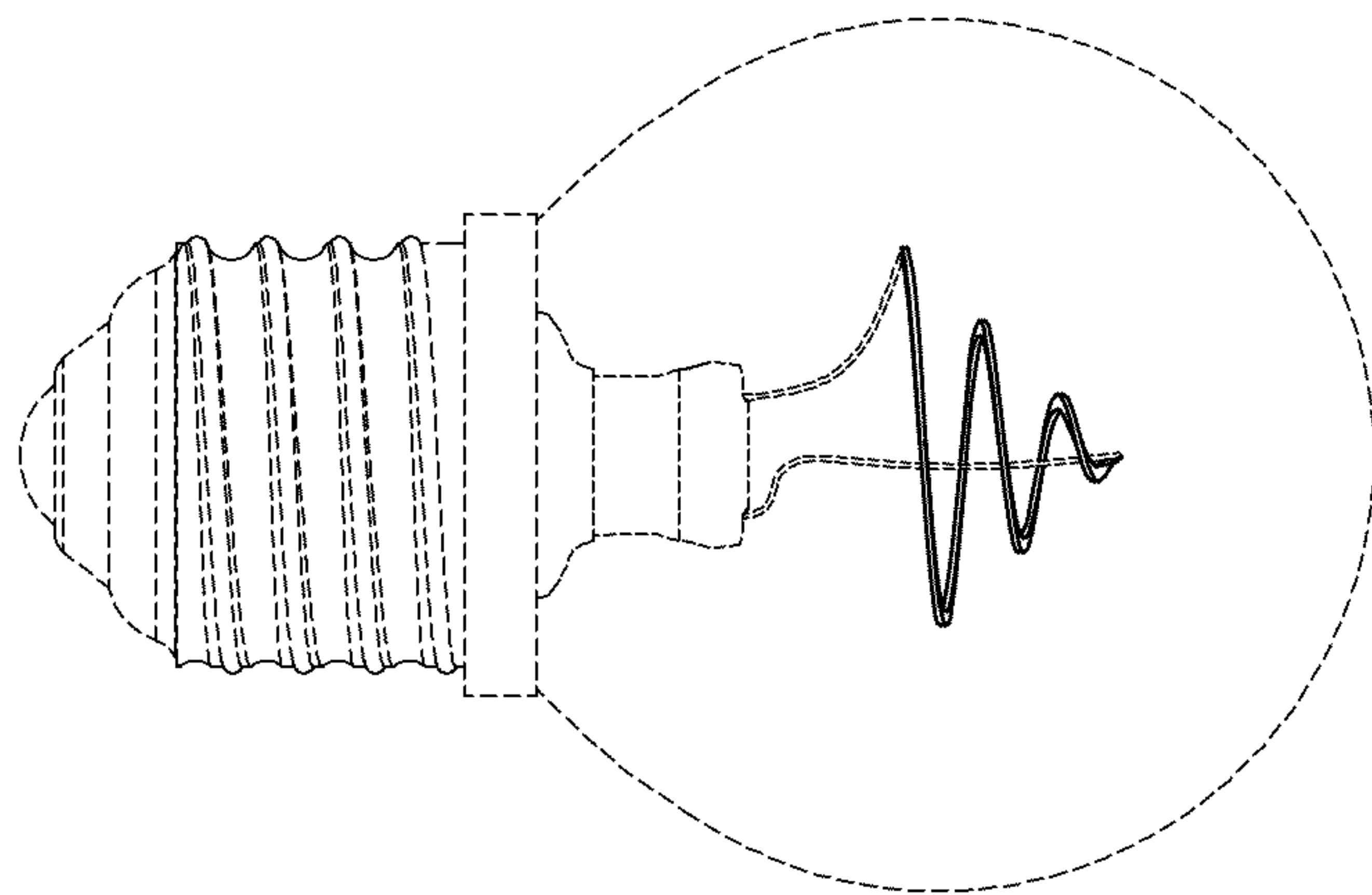

FIG. 13

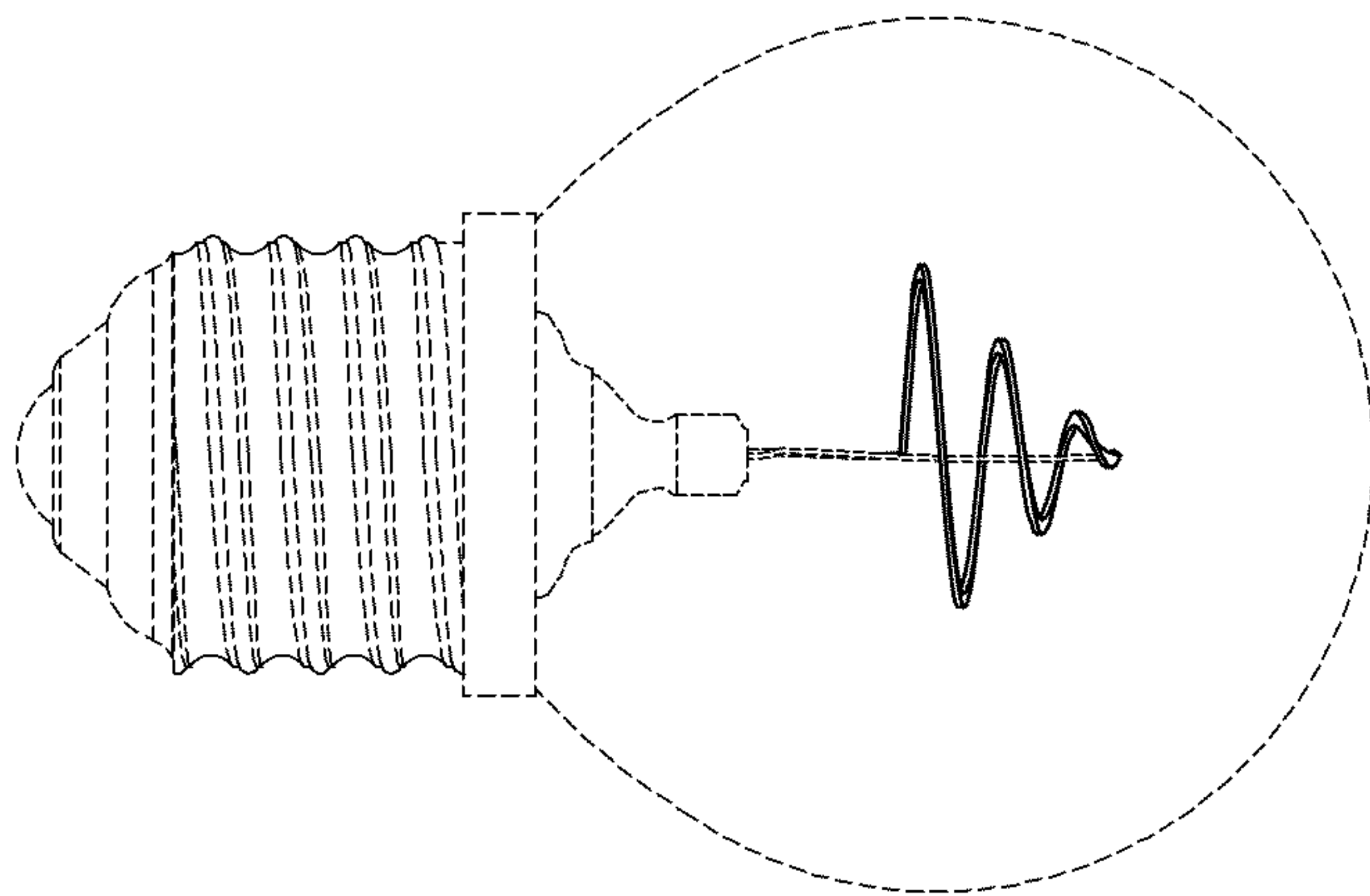

FIG. 15

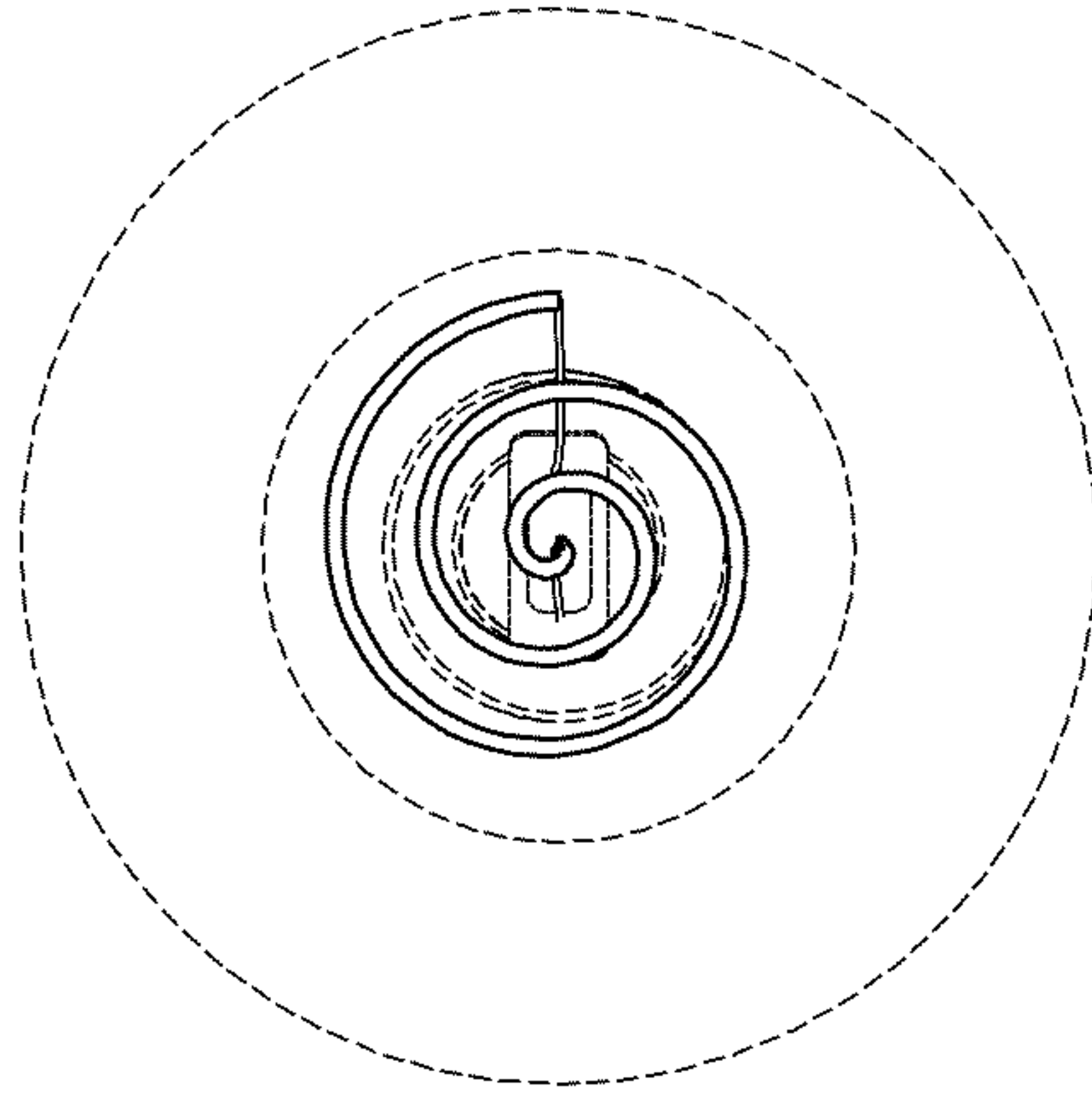

FIG. 16

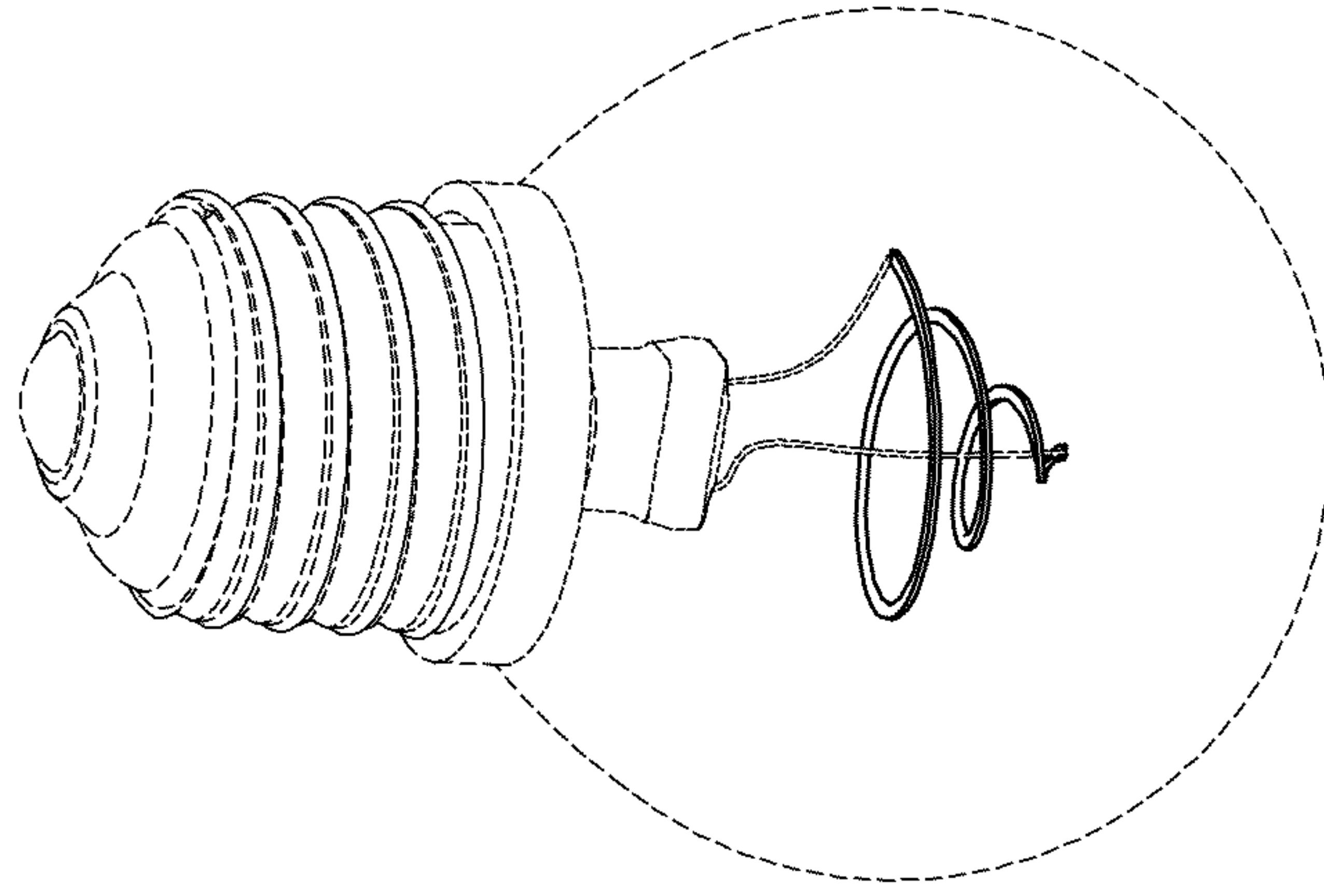

FIG. 18

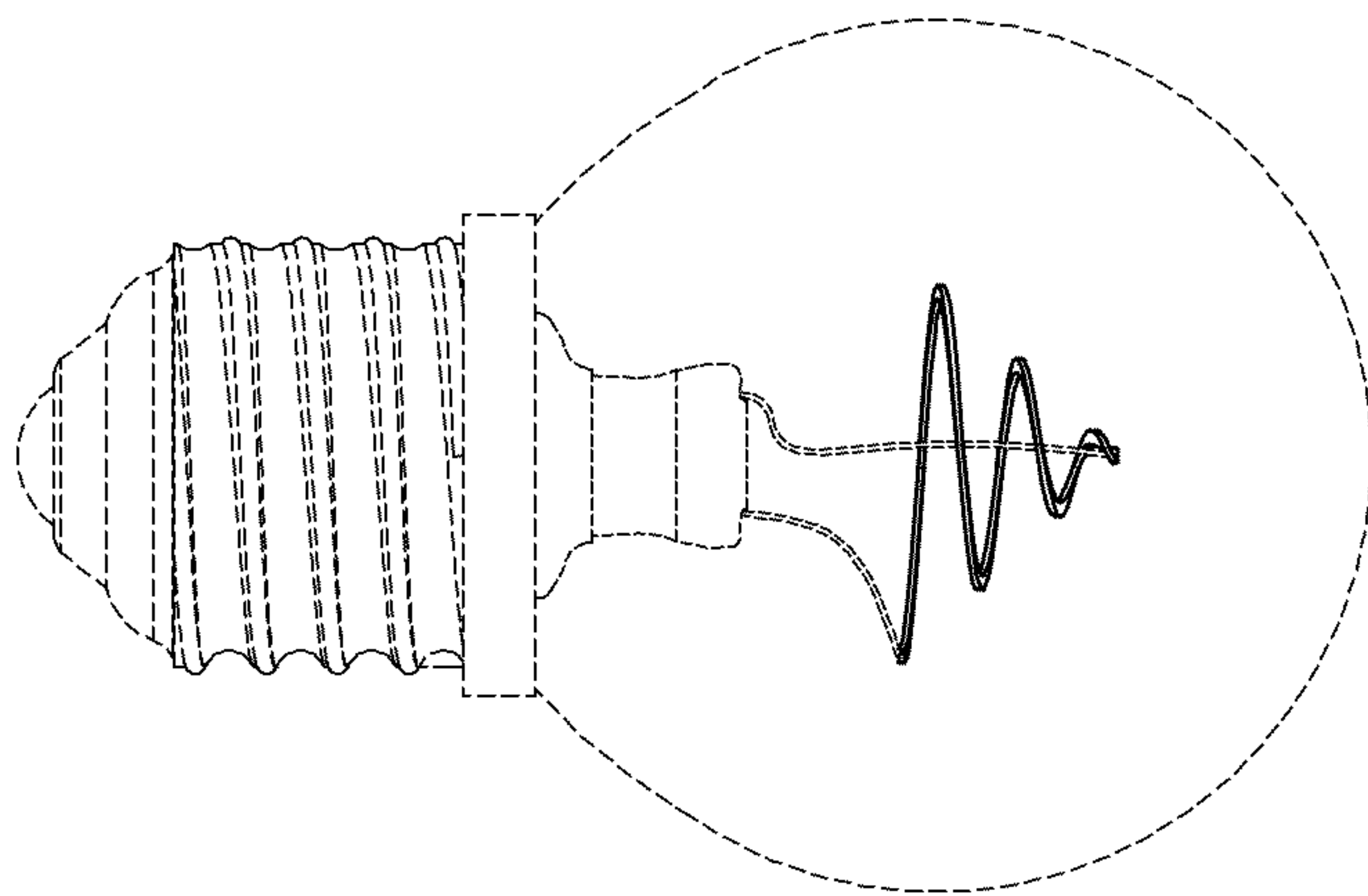

FIG. 17