



US00D759825S

(12) **United States Design Patent**
Johnson et al.

(10) **Patent No.:** **US D759,825 S**
(45) **Date of Patent:** **** Jun. 21, 2016**

(54) **LEG SUPPORT**

(71) Applicants: **Scott A. Johnson**, Centerville, OH (US);
Matthew Lawless, Xenia, OH (US)

(72) Inventors: **Scott A. Johnson**, Centerville, OH (US);
Matthew Lawless, Xenia, OH (US)

(73) Assignee: **MSM Products, LLC**, Centerville, OH
(US)

(**) Term: **14 Years**

(21) Appl. No.: **29/479,730**

(22) Filed: **Jan. 18, 2014**

(51) **LOC (10) Cl.** **24-01**

(52) **U.S. Cl.**
USPC **D24/184**

(58) **Field of Classification Search**
USPC D24/183-184, 190, 213, 215, 200, 212;
D6/502, 595, 596, 601, 648; 128/845,
128/869, 882; 5/636-640, 644, 646, 648,
5/650, 652; 602/6; 607/114; 297/423.41;
601/27

See application file for complete search history.

(56) **References Cited**

U.S. PATENT DOCUMENTS

3,931,654	A *	1/1976	Spann	5/650
3,946,451	A *	3/1976	Spann	5/650
4,071,031	A *	1/1978	Lowman	607/114
4,270,235	A *	6/1981	Gutmann	5/646
D296,932	S *	7/1988	Tranghese	D24/183
D311,470	S *	10/1990	Cosgrove et al.	D6/601
5,046,487	A *	9/1991	Scott	601/27
5,125,123	A *	6/1992	Engle	5/648
5,134,739	A *	8/1992	Gaffe et al.	5/648

D345,797	S *	4/1994	Gardner	D24/183
D359,804	S *	6/1995	Carter	D24/183
5,477,866	A *	12/1995	Davenport	5/648
5,584,303	A *	12/1996	Walle	5/648
D386,643	S *	11/1997	Farrell	D6/601
D387,167	S *	12/1997	Klein	D24/183
5,745,939	A *	5/1998	Flick et al.	5/648
5,997,491	A *	12/1999	Harris	602/6
6,032,669	A *	3/2000	Klein	128/845
D422,362	S *	4/2000	Ames	D24/183
D424,698	S *	5/2000	Ames	D24/183
D464,520	S *	10/2002	Bond	D6/601
D625,421	S *	10/2010	Sharps et al.	D24/184
D642,694	S *	8/2011	Sharps et al.	D24/190
2004/0070254	A1 *	4/2004	Conlon et al.	297/423.41
2013/0319426	A1 *	12/2013	Castle	128/845

* cited by examiner

Primary Examiner — T. Chase Nelson

Assistant Examiner — Mark Cavanna

(74) *Attorney, Agent, or Firm* — Neal O. Willmann

(57) **CLAIM**

The ornamental design for the leg support, as shown and described.

DESCRIPTION

FIG. 1 is a top plan view of a leg support showing our new design;

FIG. 2 is an auxiliary view drawn on a plane parallel to the top inclined surface of the leg support thereof;

FIG. 3 is a right side elevation view thereof, the left side view being a mirror image;

FIG. 4 is a back side elevated view thereof;

FIG. 5 is a bottom plan view thereof; and,

FIG. 6 is a perspective view thereof.

The partial leg and foot depicted in broken line illustrates environment and form no part of the claimed design.

1 Claim, 6 Drawing Sheets

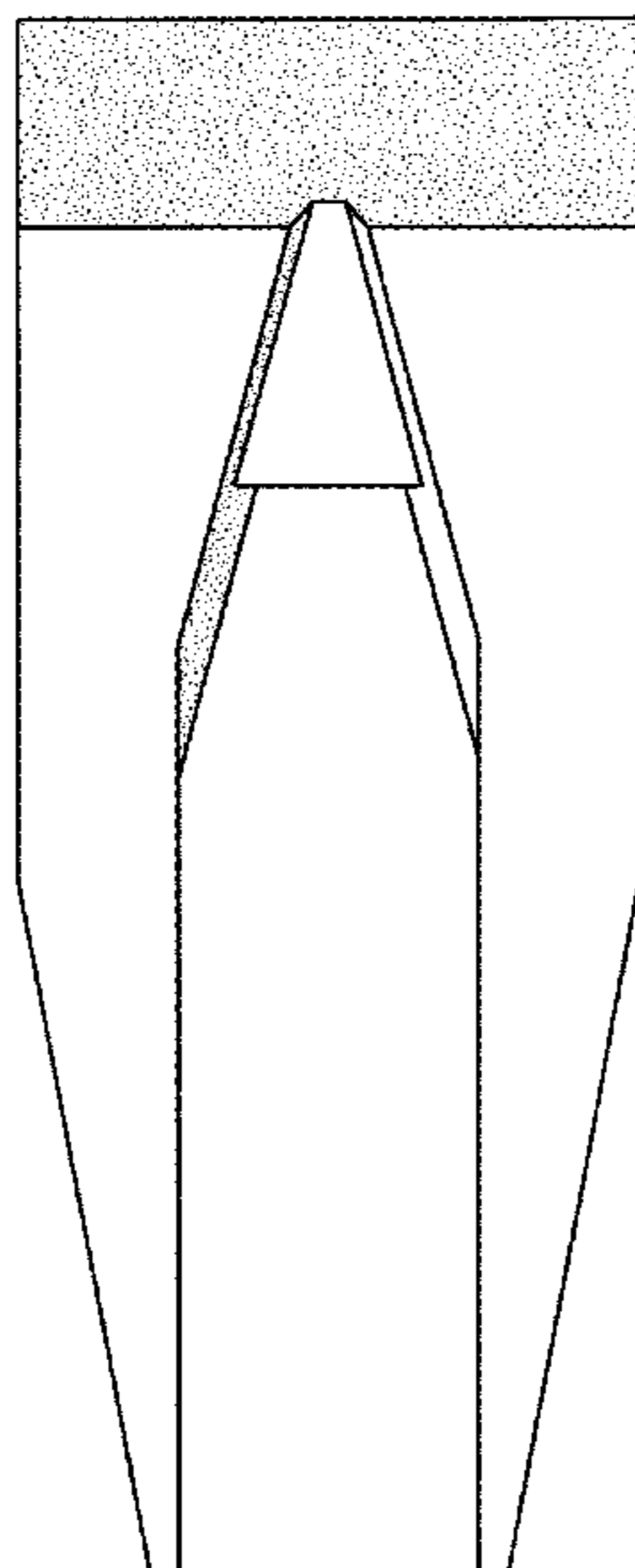

Fig. 1

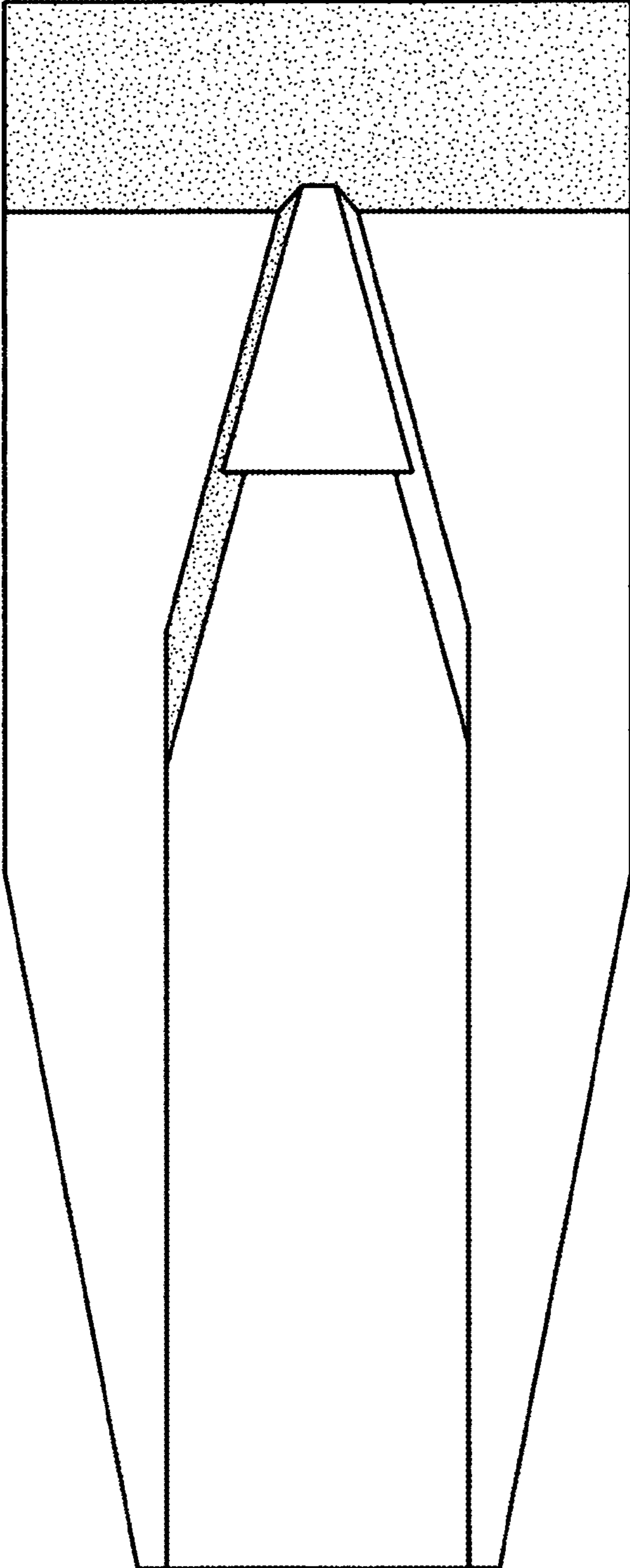

Fig. 2

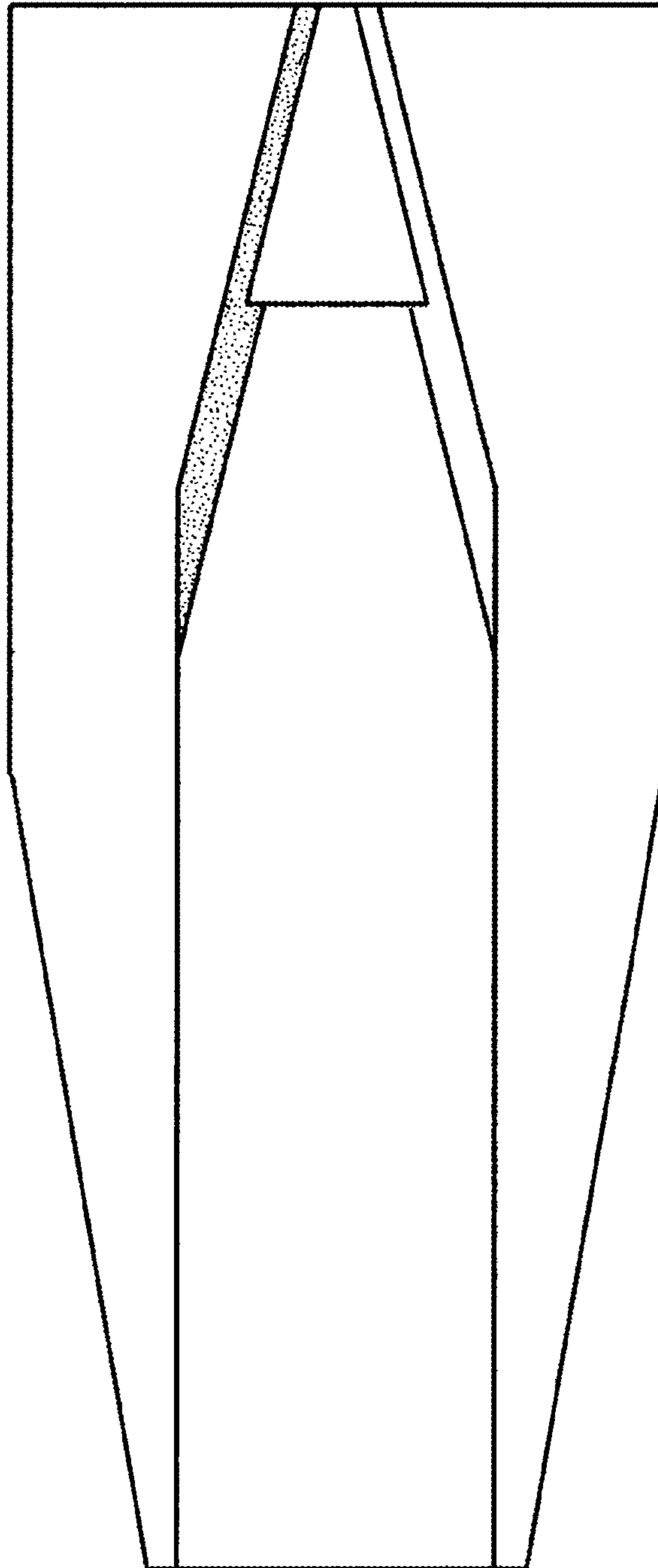

Fig. 3

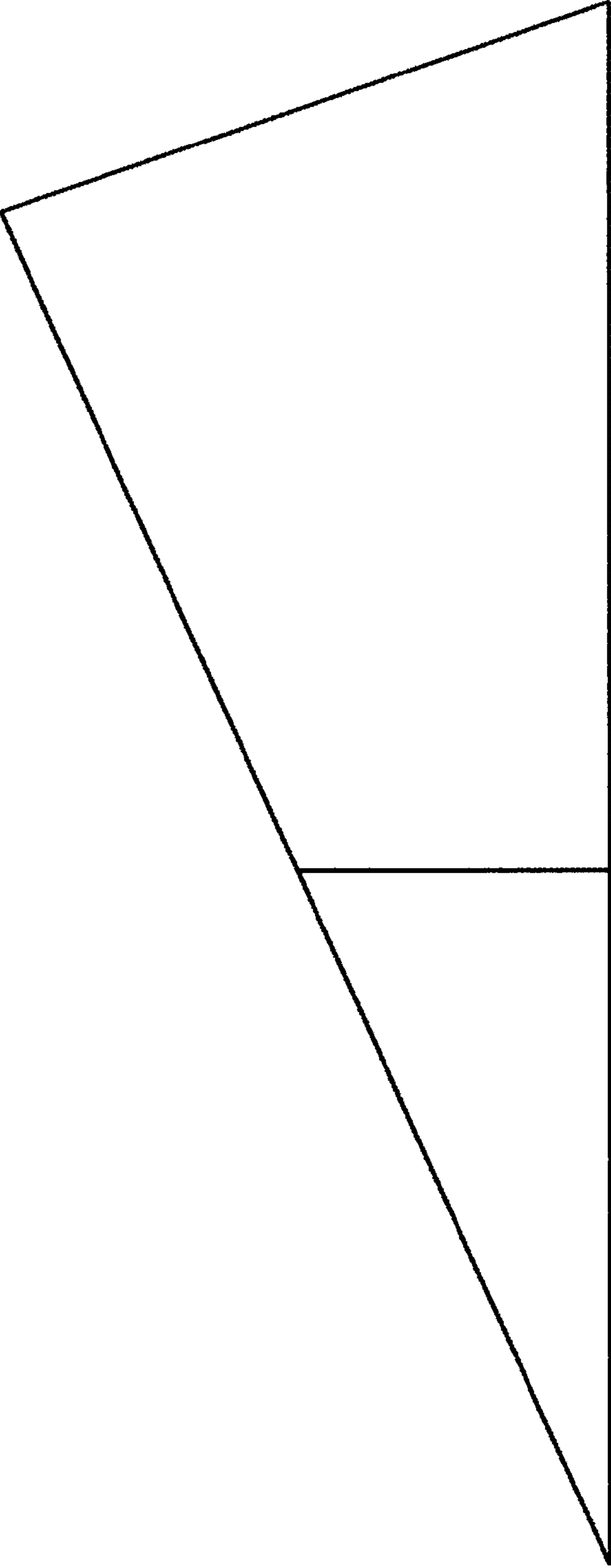

Fig. 4

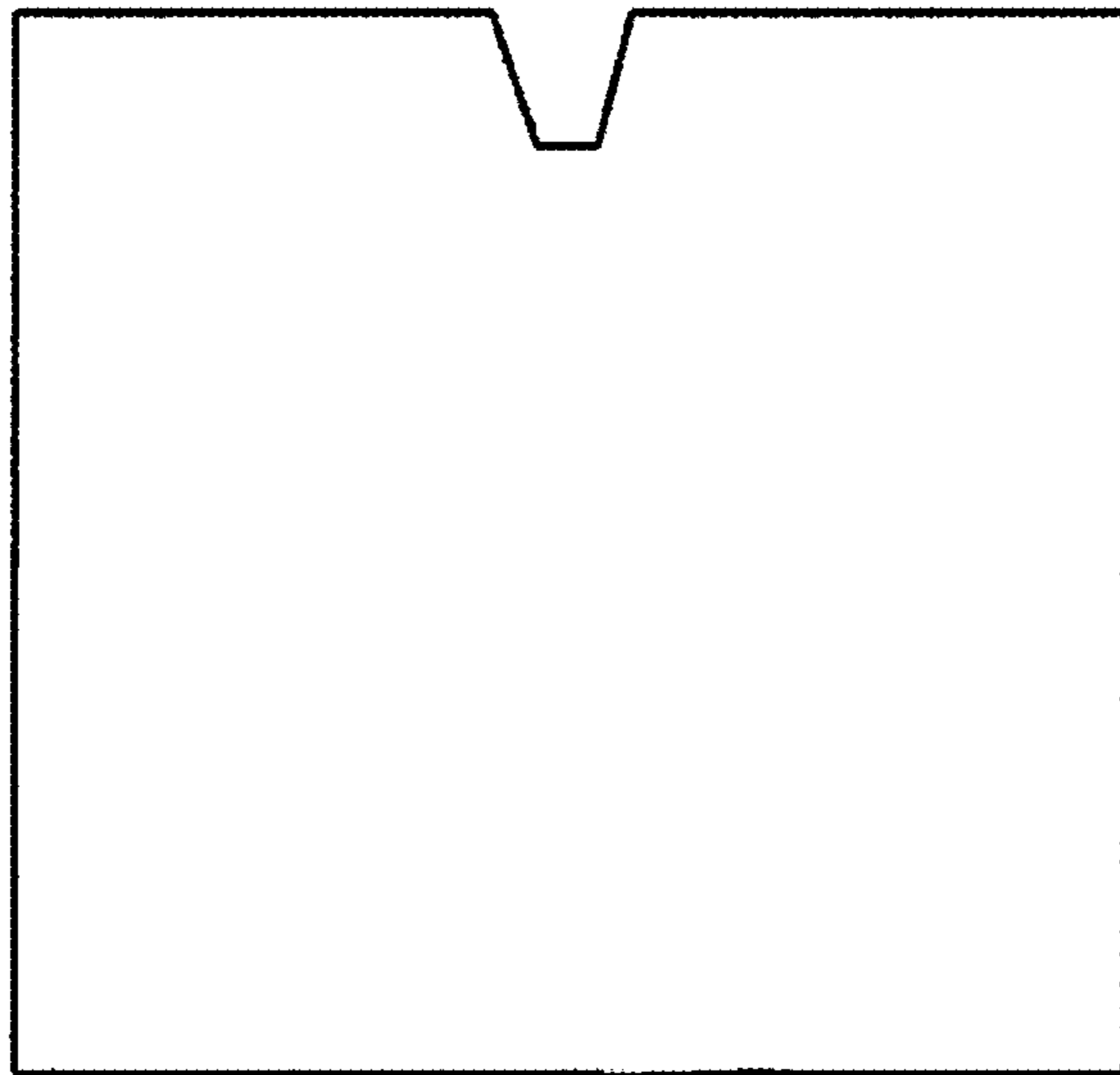
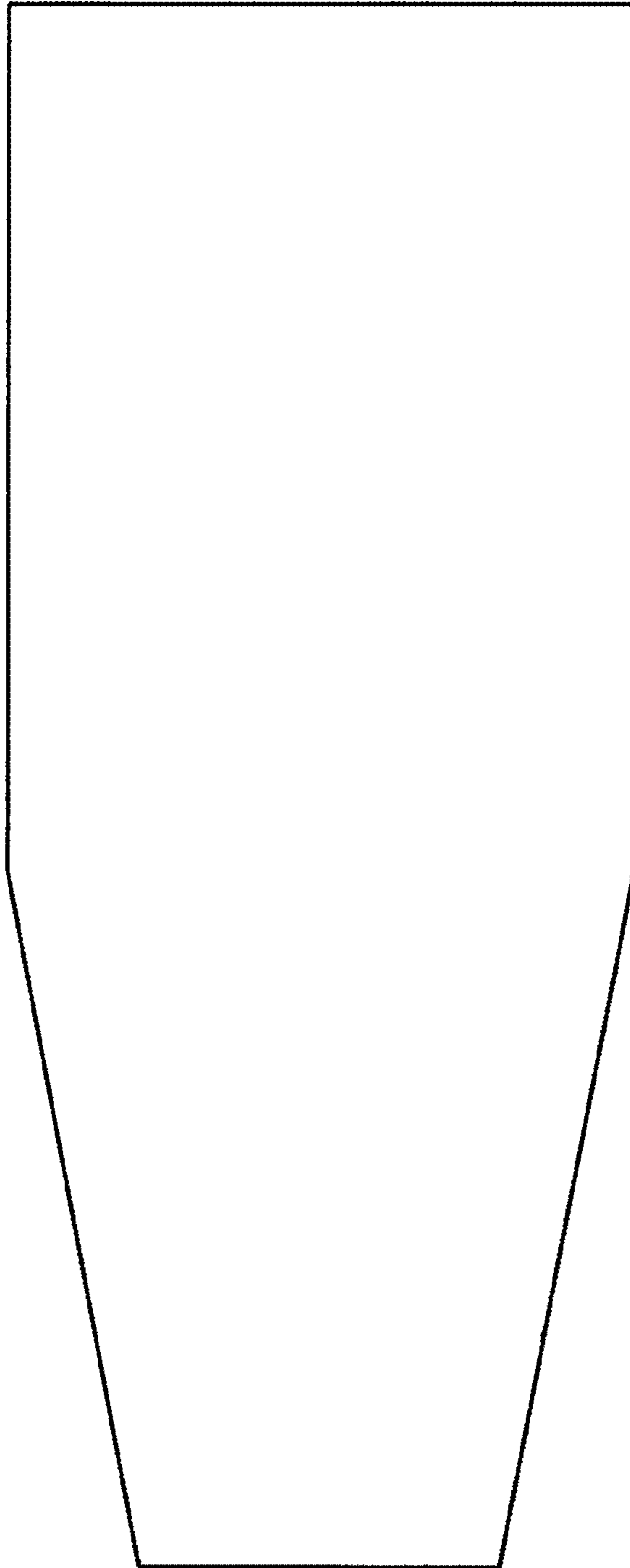

Fig. 5



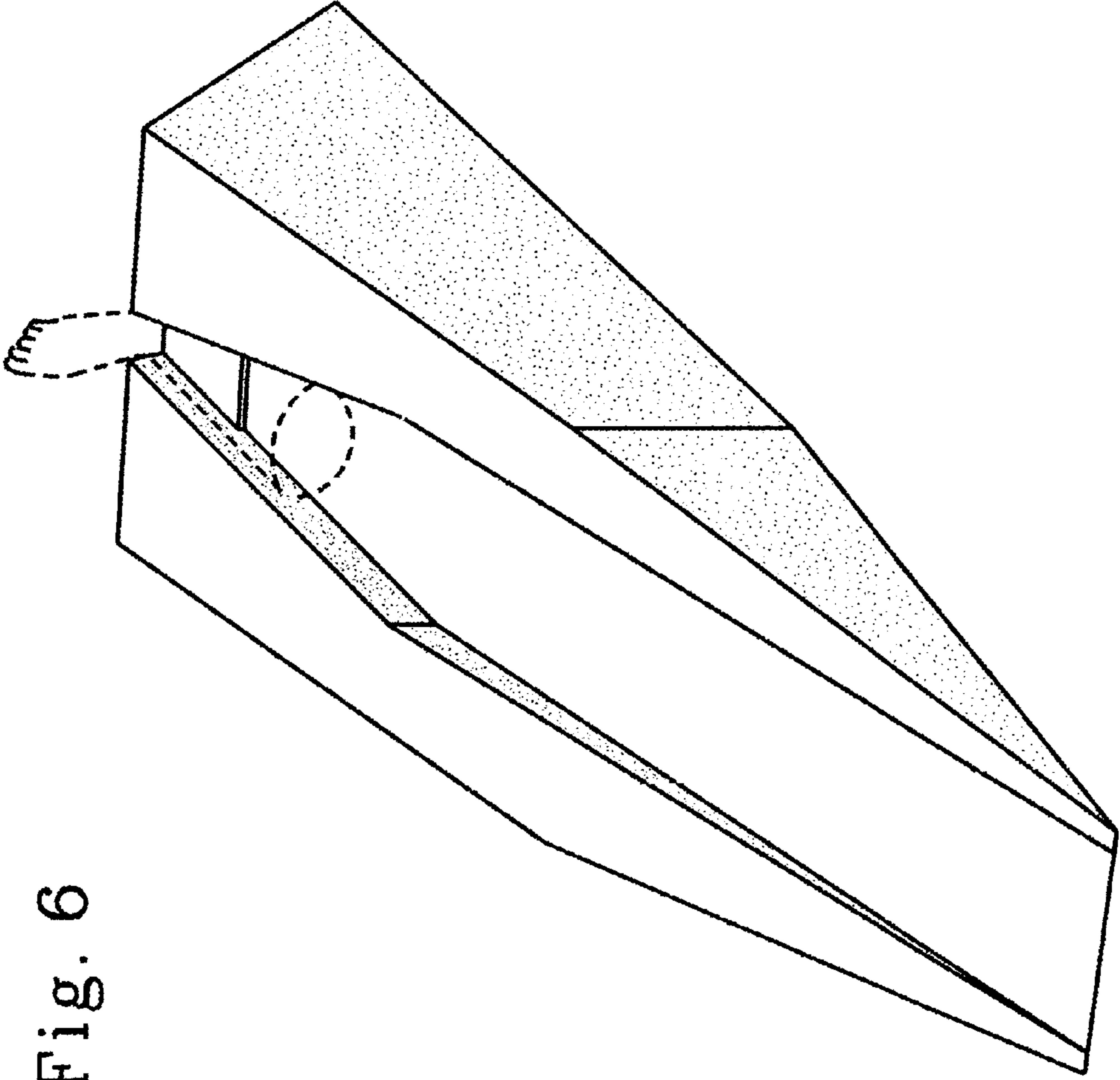

Fig. 6