



US00D759786S

(12) **United States Design Patent**
Laber

(10) **Patent No.:** **US D759,786 S**
(45) **Date of Patent:** **** Jun. 21, 2016**

- (54) **TANK FOR A BACKPACK SPRAYER**
- (71) Applicant: **CHAPIN MANUFACTURING, INC.**,
Batavia, NY (US)
- (72) Inventor: **Michael R. Laber**, Hilton, NY (US)
- (73) Assignee: **CHAPIN MANUFACTURING, INC.**,
Batavia, NY (US)
- (**) Term: **15 Years**
- (21) Appl. No.: **29/527,135**
- (22) Filed: **May 15, 2015**
- (51) **LOC (10) Cl.** **23-01**
- (52) **U.S. Cl.**
USPC **D23/202; D23/225; D15/13**
- (58) **Field of Classification Search**
USPC D15/13; D23/213, 202, 225; 220/565,
220/562; 239/310, 373, 337, 332-333,
239/152-154
CPC B05B 9/08; B05B 9/0426; B05B 9/04;
A62C 15/00
See application file for complete search history.

- D477,783 S 7/2003 Gilmore et al.
- D490,299 S 5/2004 Byron
- 6,729,558 B1 * 5/2004 Seenaath B05B 7/1422
239/152
- 6,769,628 B1 * 8/2004 Vaage B05B 7/2427
239/152
- 7,007,826 B2 * 3/2006 Shapanus B05B 9/0861
222/175
- D527,789 S 9/2006 Thompson et al.
- 7,104,468 B2 9/2006 Stengel
- 7,134,612 B2 11/2006 Bertucci et al.
- 7,175,104 B2 * 2/2007 Allen, IV A01M 7/0046
239/146
- D547,416 S 7/2007 Hillhouse
- 7,347,386 B2 3/2008 Chen
- D567,897 S 4/2008 Hillhouse
- D570,447 S 6/2008 Hillhouse

(Continued)

OTHER PUBLICATIONS

U.S. Trademark Registration No. 2,596,935.

(Continued)

Primary Examiner — Mark Goodwin

(74) *Attorney, Agent, or Firm* — Kenneth J. Lukacher Law Group

(57) **CLAIM**

The ornamental design for a tank for a backpack sprayer, as shown and described.

DESCRIPTION

FIG. 1 is a front elevational of a tank for a backpack sprayer in accordance with my design;
 FIG. 2 is a rear elevational view thereof;
 FIG. 3 is a top view thereof;
 FIG. 4 is a bottom view thereof;
 FIG. 5 is a left side view thereof
 FIG. 6 is a right side view thereof; and,
 FIG. 7 is a perspective view looking downwardly from the right toward the front.
 The dashed lines in figures below the bottom of the tank shown form no part of the claimed design.

1 Claim, 7 Drawing Sheets

(56) **References Cited**

U.S. PATENT DOCUMENTS

- D190,773 S * 6/1961 Koch D12/218
- D229,612 S 12/1973 German
- D285,475 S 9/1986 Born
- 4,690,331 A 9/1987 Luchsinger
- 4,798,333 A 1/1989 Luchsinger
- D327,528 S 6/1992 Sears et al.
- D337,368 S 7/1993 Berfield et al.
- 5,335,853 A 8/1994 Wirz
- 5,636,791 A * 6/1997 Leer B05B 9/0877
239/142
- D398,223 S 9/1998 Bertolini et al.
- D399,853 S * 10/1998 Prosper D15/13
- D406,313 S 3/1999 Prosper et al.
- 5,984,199 A * 11/1999 Restive B05B 9/0877
239/1
- 6,412,707 B1 7/2002 Wirz
- D464,874 S 10/2002 Tune et al.

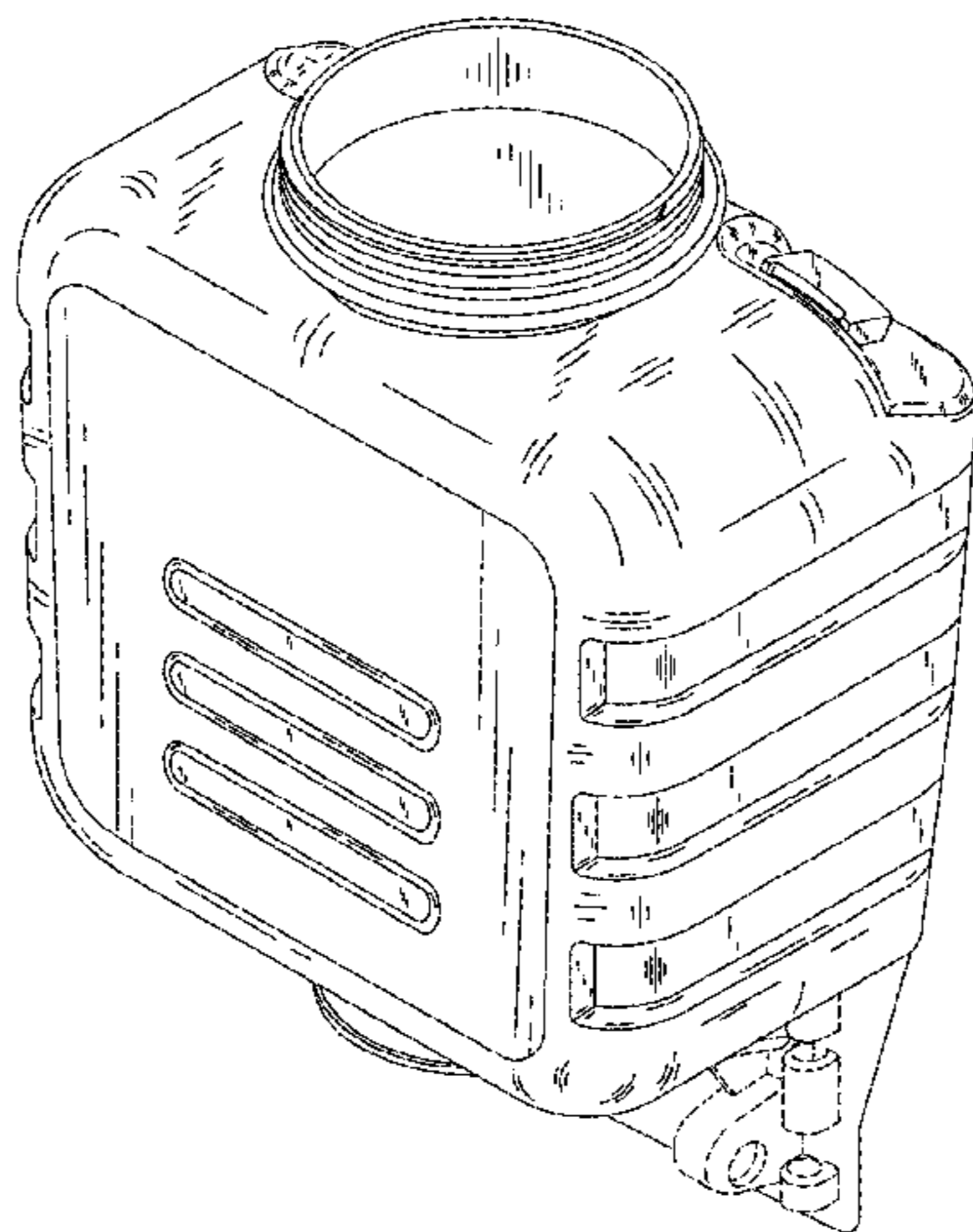

(56)

References Cited

U.S. PATENT DOCUMENTS

D590,043 S 4/2009 Campbell
D591,387 S 4/2009 Campbell
D594,087 S 6/2009 Campbell
D604,385 S * 11/2009 Fontaine D23/202
D609,773 S 2/2010 Abernethy et al.
D616,959 S 6/2010 Wu
D618,300 S 6/2010 Hudson et al.
D633,984 S 3/2011 Plantz
D652,111 S 1/2012 Delorme
D672,848 S * 12/2012 Wirz Luchsinger D23/202
D673,644 S 1/2013 Delorme
D673,645 S 1/2013 Delorme

D685,057 S * 6/2013 Wirz Luchsinger D23/202
D698,003 S 1/2014 Delorme
D719,637 S * 12/2014 Pagliai D23/225
D719,638 S * 12/2014 Pagliai D23/225
D725,742 S * 3/2015 Kennemer D23/225
2007/0278326 A1 12/2007 Wu

OTHER PUBLICATIONS

U.S. Trademark Registration No. 2,587,356.
U.S. Trademark Registration No. 3,311,675.
Solo, Online Troubleshooting/Resource Center, Website page at
<http://tess2.uspto.gov/bin/showfield?f=doc&state=bbov69.2.1>,
printed Jan. 17, 2006.

* cited by examiner

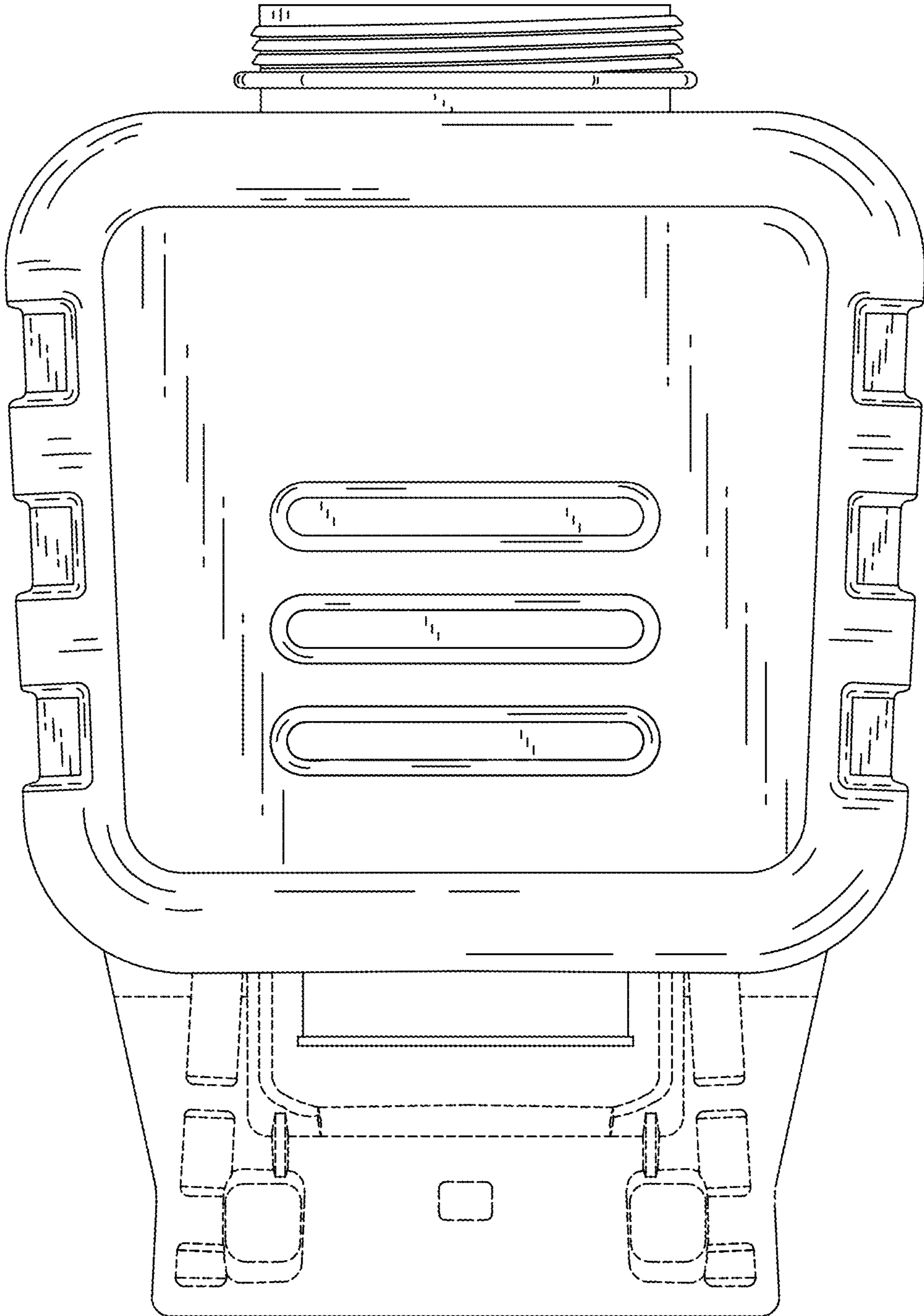

FIG. 1

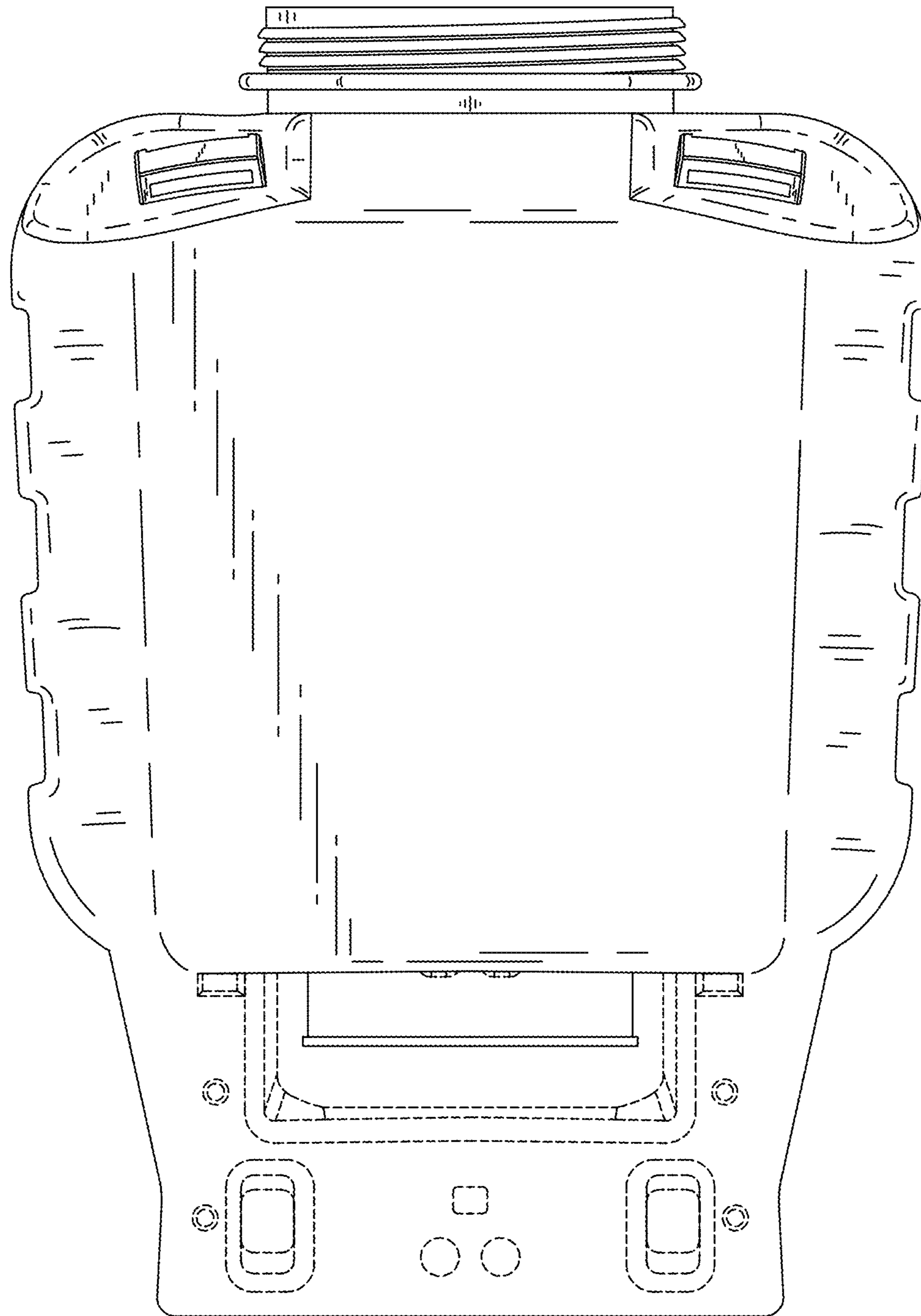

FIG. 2

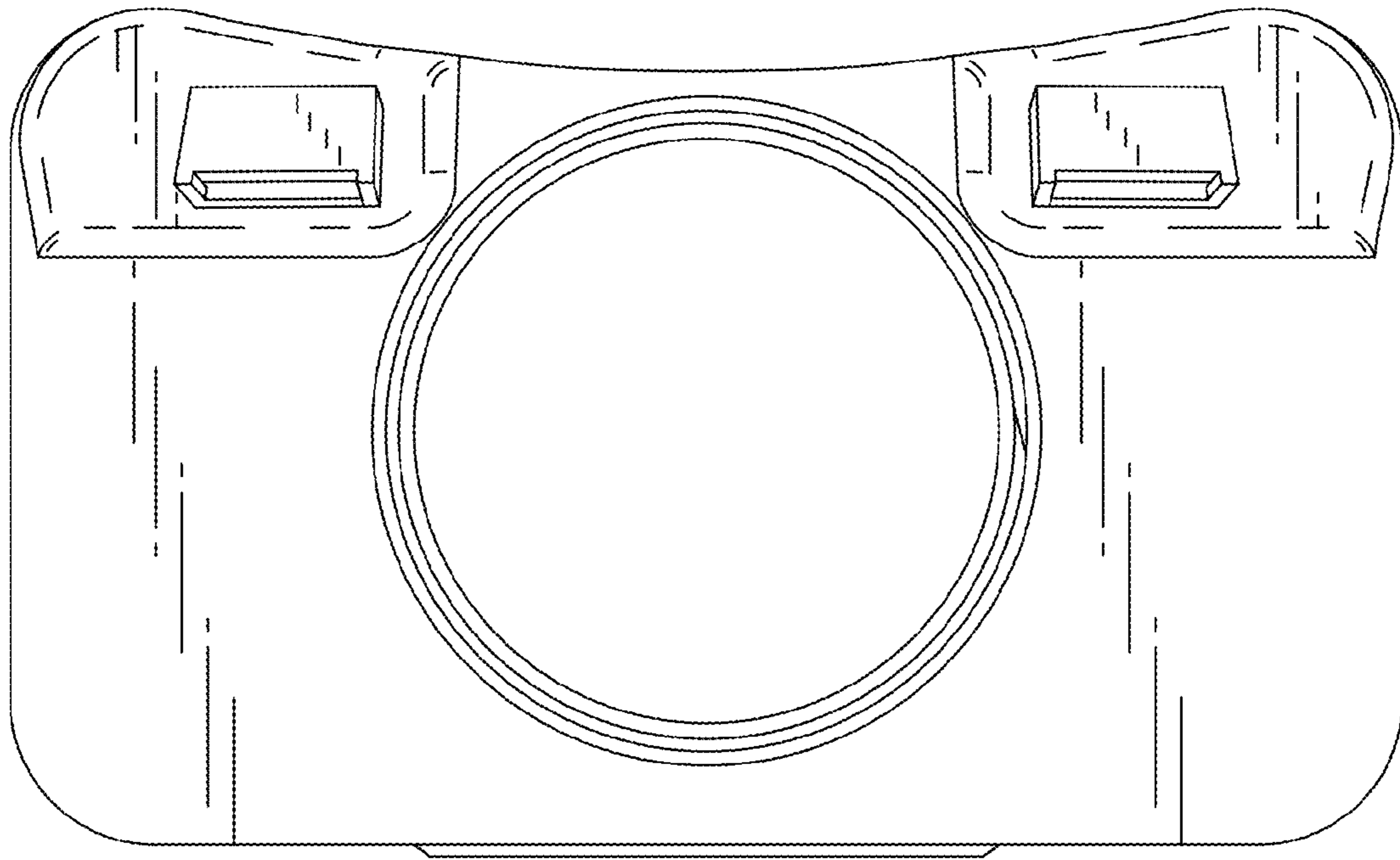

FIG. 3

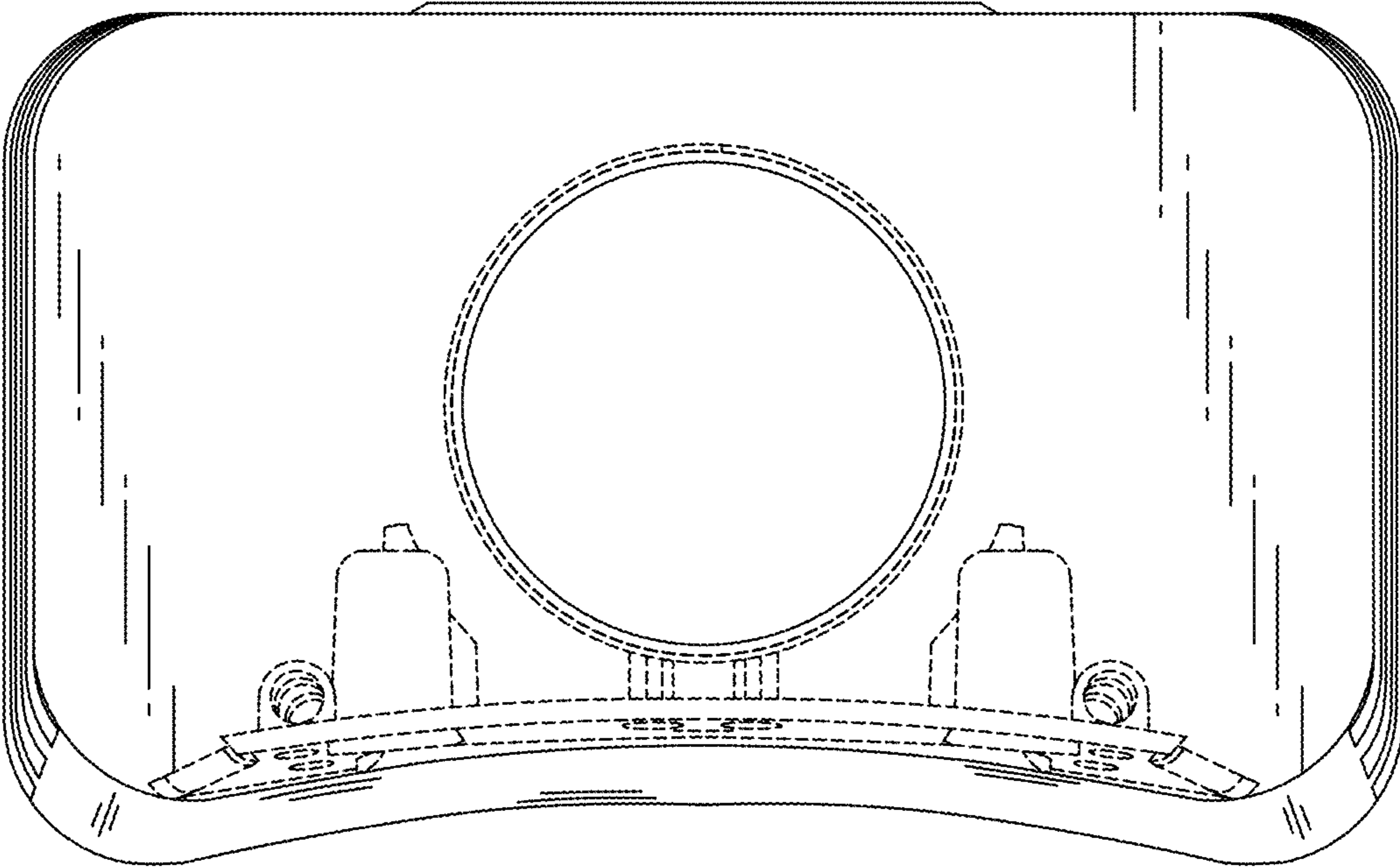

FIG. 4

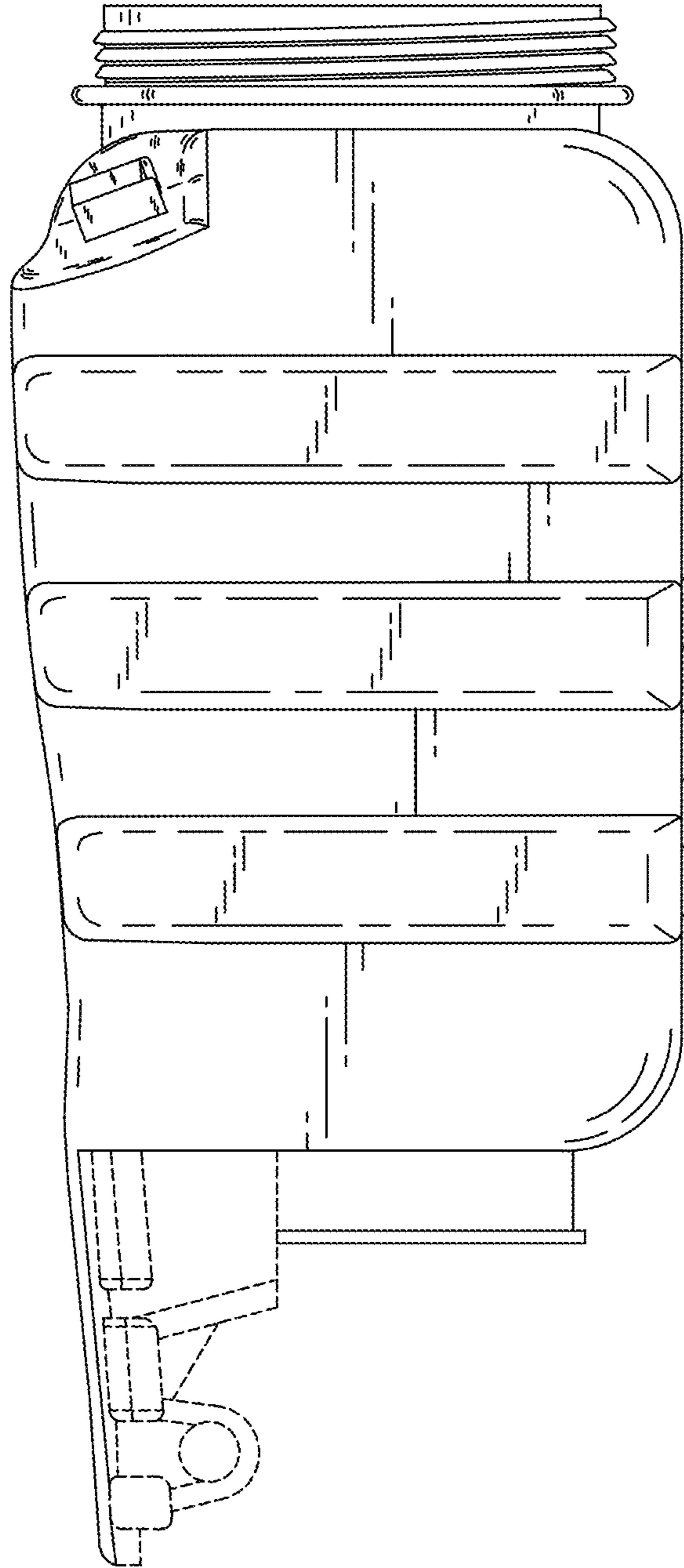

FIG. 5

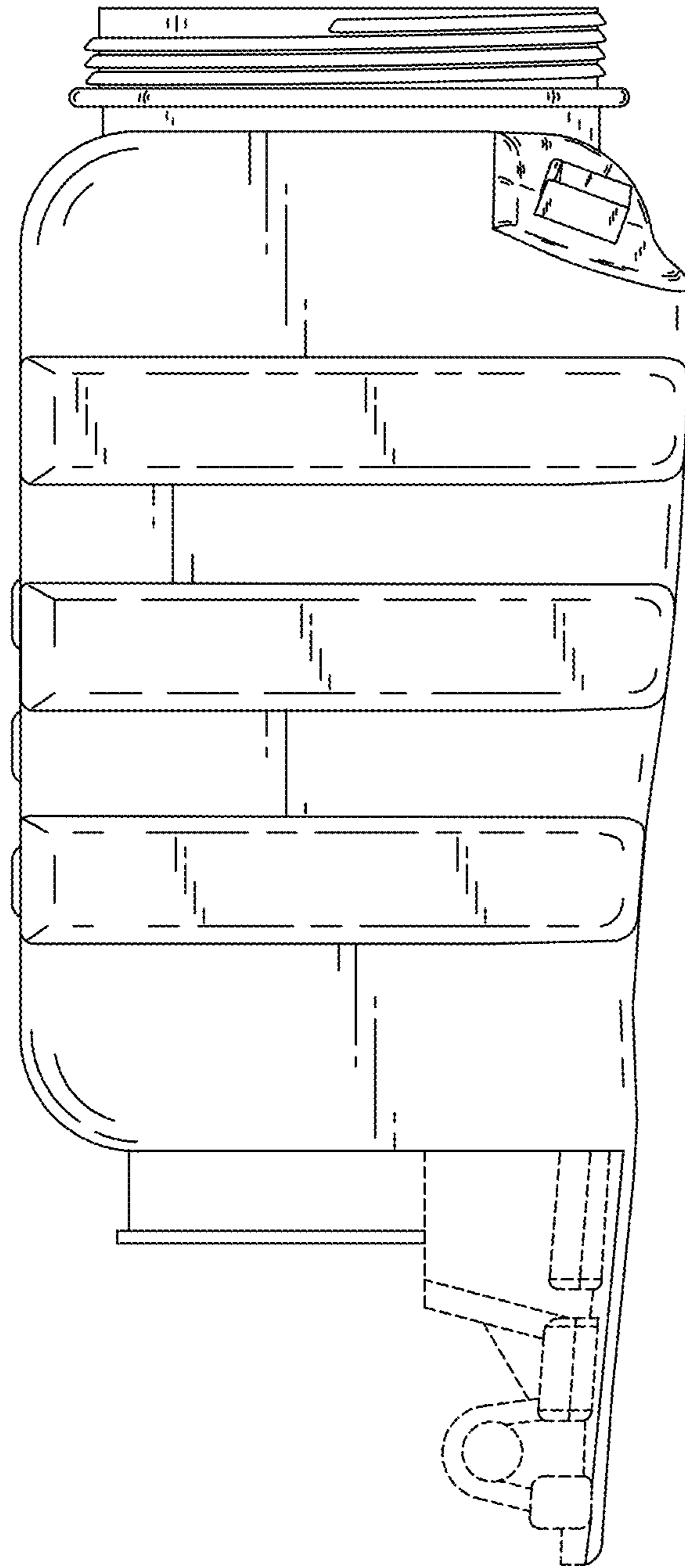

FIG. 6

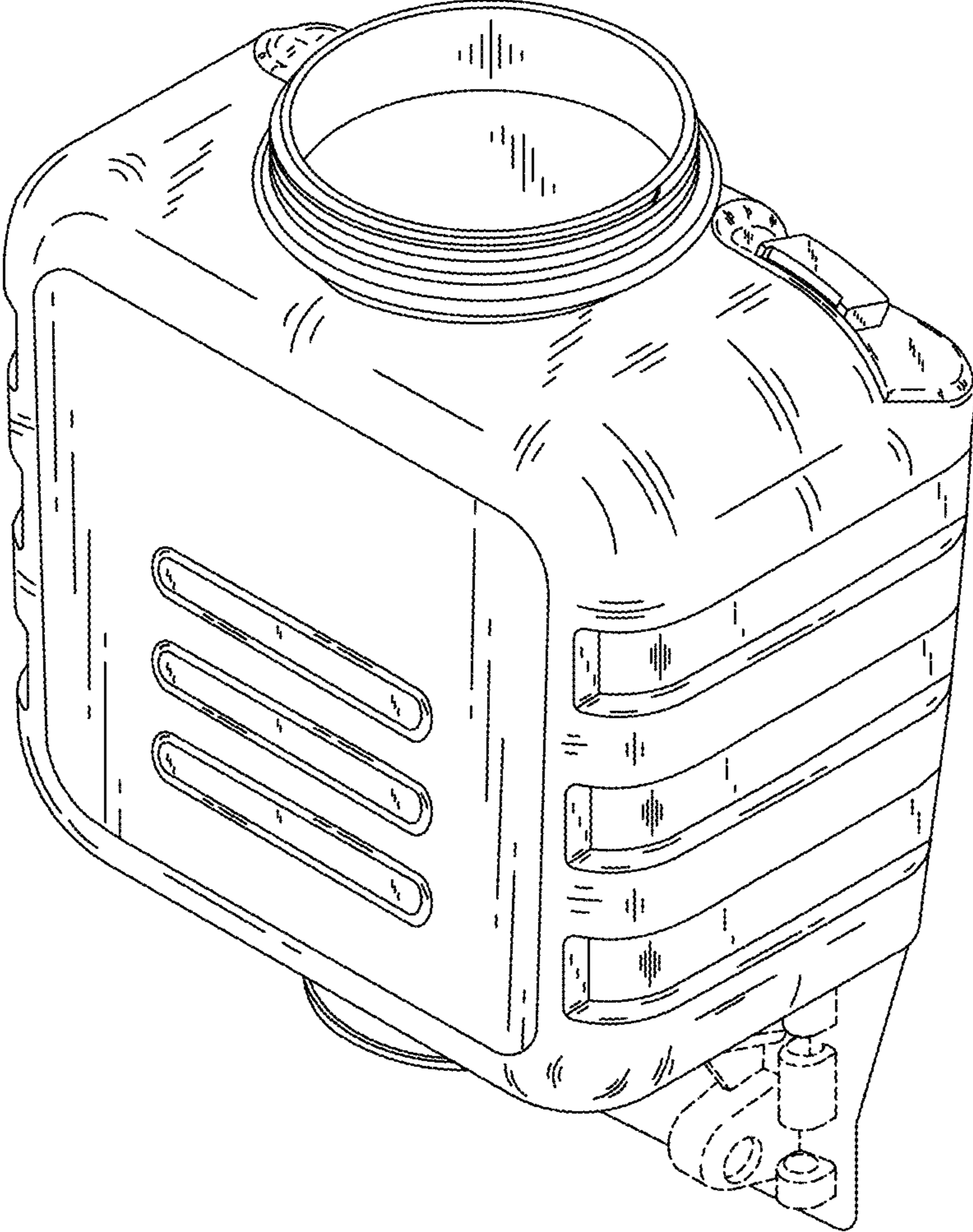

FIG. 7