



US00D759761S

(12) **United States Design Patent**
Connell

(10) **Patent No.:** **US D759,761 S**
(45) **Date of Patent:** **** Jun. 21, 2016**

(54) **WALL HANGING CHESSBOARD**

(71) Applicant: **Sean Dennis Connell**, Lafayette, IN (US)

(72) Inventor: **Sean Dennis Connell**, Lafayette, IN (US)

(**) Term: **14 Years**

(21) Appl. No.: **29/500,202**

(22) Filed: **Aug. 22, 2014**

(51) **LOC (10) Cl.** **21-01**

(52) **U.S. Cl.**
USPC **D21/337; D21/341; D21/389; D21/349; D21/388**

(58) **Field of Classification Search**
USPC D21/334, 336, 337, 338, 341, 349, 386, D21/388, 389; 273/236, 241, 242, 260, 287, 273/288, 290, 148 R, 309, 282.1, 283
CPC A63F 3/00173; A63F 3/00261; A63F 3/00542; A63F 3/00697; A63F 3/02; A63F 2003/0022; A63F 2003/00223; A63F 2003/0023; A63F 2003/00406; A63F 2003/0041; A63F 2003/00457; A63F 2003/00533; A63F 2003/00536; A63F 2003/00539; A63F 2003/00558; A63F 2003/00599; A63F 2003/007; A63F 2003/00842; A63F 2003/0845

See application file for complete search history.

(56) **References Cited**

U.S. PATENT DOCUMENTS

163,601 A * 5/1875 Morgan A63F 3/00574 273/281
D8,466 S * 7/1875 Lyman D21/499
286,395 A * 10/1883 Decker A63F 9/0826 273/153 S
687,487 A * 11/1901 Powell A63F 3/0695 273/281

1,666,359 A * 4/1928 Steves A63F 3/02 273/267
1,793,256 A * 2/1931 Shulman A63F 3/0023 273/285
D157,472 S * 2/1950 Drazan D19/20
3,376,042 A * 4/1968 Dunlap A63F 3/00574 273/236
3,410,011 A * 11/1968 Bowman A63F 3/00261 273/271
3,427,028 A * 2/1969 Abrahamsen A63F 3/0423 273/272
3,506,267 A * 4/1970 Taillie A63F 3/00 273/146
3,610,627 A * 10/1971 Peebles A63F 3/0023 273/282.1
3,680,867 A * 8/1972 Zimmerman A63F 1/12 273/144 B
3,747,932 A * 7/1973 Grissino A63F 3/00097 273/248
3,770,273 A * 11/1973 Reiner A63F 9/0073 273/271
3,781,014 A * 12/1973 Kolwicz A63F 3/02 273/260
D232,646 S * 9/1974 Stubbmann 273/260
3,904,206 A * 9/1975 Kolwicz A63F 3/02 273/260

(Continued)

Primary Examiner — Susan Moon Lee

(57) **CLAIM**
The ornamental design for a wall hanging chessboard, as shown.

DESCRIPTION

FIG. 1 is a top perspective view of a wall hanging chessboard showing my new design;
FIG. 2 is a front view thereof;
FIG. 3 is a right side view thereof;
FIG. 4 is a back view thereof;
FIG. 5 is a top view thereof;
FIG. 6 is a bottom view thereof; and,
FIG. 7 is an exploded view thereof.

1 Claim, 6 Drawing Sheets

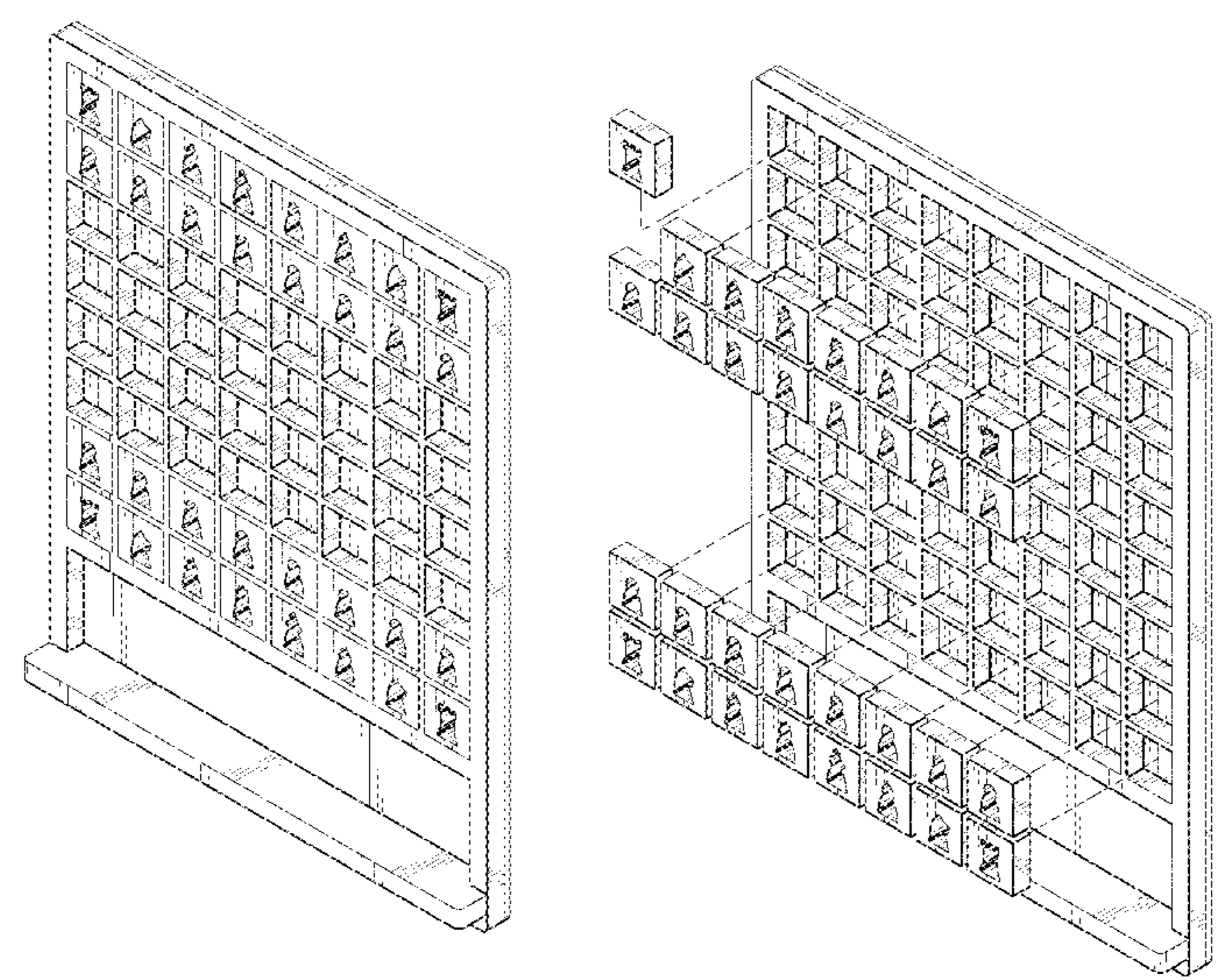

(56)

References Cited

U.S. PATENT DOCUMENTS

| | | | | | | | | | |
|--------------|------|---------|------------------|-------|--------------|-----------|--|--|--|
| 3,929,337 | A * | 12/1975 | Hayes | | A63F 3/00574 | 273/146 | | | |
| D239,848 | S * | 5/1976 | Wessborg | | D21/341 | | | | |
| D241,862 | S * | 10/1976 | Cloff | | D21/349 | | | | |
| D245,422 | S * | 8/1977 | Vanderhyden, Jr. | | D19/25 | | | | |
| 4,055,345 | A * | 10/1977 | Havlik | | A63F 3/00574 | 273/260 | | | |
| 4,057,253 | A * | 11/1977 | Csoka | | A63F 3/00097 | 273/153 R | | | |
| 4,083,564 | A * | 4/1978 | Matsumoto | | A63F 3/00694 | 273/239 | | | |
| 4,147,362 | A * | 4/1979 | Fisher | | A63F 3/00697 | 273/282.1 | | | |
| 4,188,035 | A * | 2/1980 | Metzler, Jr. | | A63F 3/00697 | 273/260 | | | |
| 4,198,055 | A * | 4/1980 | Imatt | | A63F 3/00697 | 273/243 | | | |
| D255,129 | S * | 5/1980 | Strongin | | D21/341 | | | | |
| D264,857 | S * | 6/1982 | Aitkens | | D21/338 | | | | |
| 4,448,420 | A * | 5/1984 | Escamilla-Kelly | ... | A63F 3/0415 | 273/241 | | | |
| 4,448,423 | A * | 5/1984 | Augusta | | A63F 3/0423 | 273/272 | | | |
| 4,512,584 | A * | 4/1985 | Propsom | | A63F 3/00574 | 273/282.1 | | | |
| D281,177 | S * | 10/1985 | Tilbor | | D21/341 | | | | |
| D282,265 | S * | 1/1986 | Hyland | | D21/336 | | | | |
| D283,012 | S * | 3/1986 | Jankens | | D32/55 | | | | |
| 4,601,473 | A * | 7/1986 | Dubren | | A63F 3/0423 | 273/272 | | | |
| D285,318 | S * | 8/1986 | Propsom | | D21/341 | | | | |
| D296,797 | S * | 7/1988 | Andrews | | D21/335 | | | | |
| D297,244 | S * | 8/1988 | Kennedy | | D19/25 | | | | |
| 4,783,081 | A * | 11/1988 | Eckhardt | | A63F 3/00261 | 273/281 | | | |
| 5,054,789 | A * | 10/1991 | Pellerin | | A63F 3/0423 | 273/288 | | | |
| D325,050 | S * | 3/1992 | Docherty | | D21/336 | | | | |
| D363,091 | S * | 10/1995 | Dobis | | D21/336 | | | | |
| 5,503,400 | A * | 4/1996 | Silva | | A63F 3/02 | 273/239 | | | |
| 5,580,059 | A * | 12/1996 | Marks | | A63F 3/00094 | 273/271 | | | |
| D403,025 | S * | 12/1998 | Martinez | | D21/337 | | | | |
| D421,776 | S * | 3/2000 | Borg | | D21/336 | | | | |
| D434,456 | S * | 11/2000 | Bracken | | D21/336 | | | | |
| 6,176,704 | B1 * | 1/2001 | Gilbert | | G09B 17/00 | 434/178 | | | |
| D453,537 | S * | 2/2002 | Shoptaugh | | D21/342 | | | | |
| 7,219,895 | B1 * | 5/2007 | Hutchins, Jr. | | A63F 3/02 | 273/236 | | | |
| D549,288 | S * | 8/2007 | Droznika | | D21/341 | | | | |
| D585,096 | S * | 1/2009 | Lin | | D21/341 | | | | |
| D646,334 | S * | 10/2011 | Ingram | | D21/303 | | | | |
| 8,132,814 | B1 * | 3/2012 | Ganti | | A63F 3/00173 | 273/148 R | | | |
| D657,824 | S * | 4/2012 | Sorrell | | D21/365 | | | | |
| D676,089 | S * | 2/2013 | Schrier | | D21/337 | | | | |
| D713,892 | S * | 9/2014 | Bednar | | D21/349 | | | | |
| D717,878 | S * | 11/2014 | Yang | | D21/348 | | | | |
| 2012/0200038 | A1 * | 8/2012 | Pollock | | A63F 3/02 | 273/260 | | | |

* cited by examiner

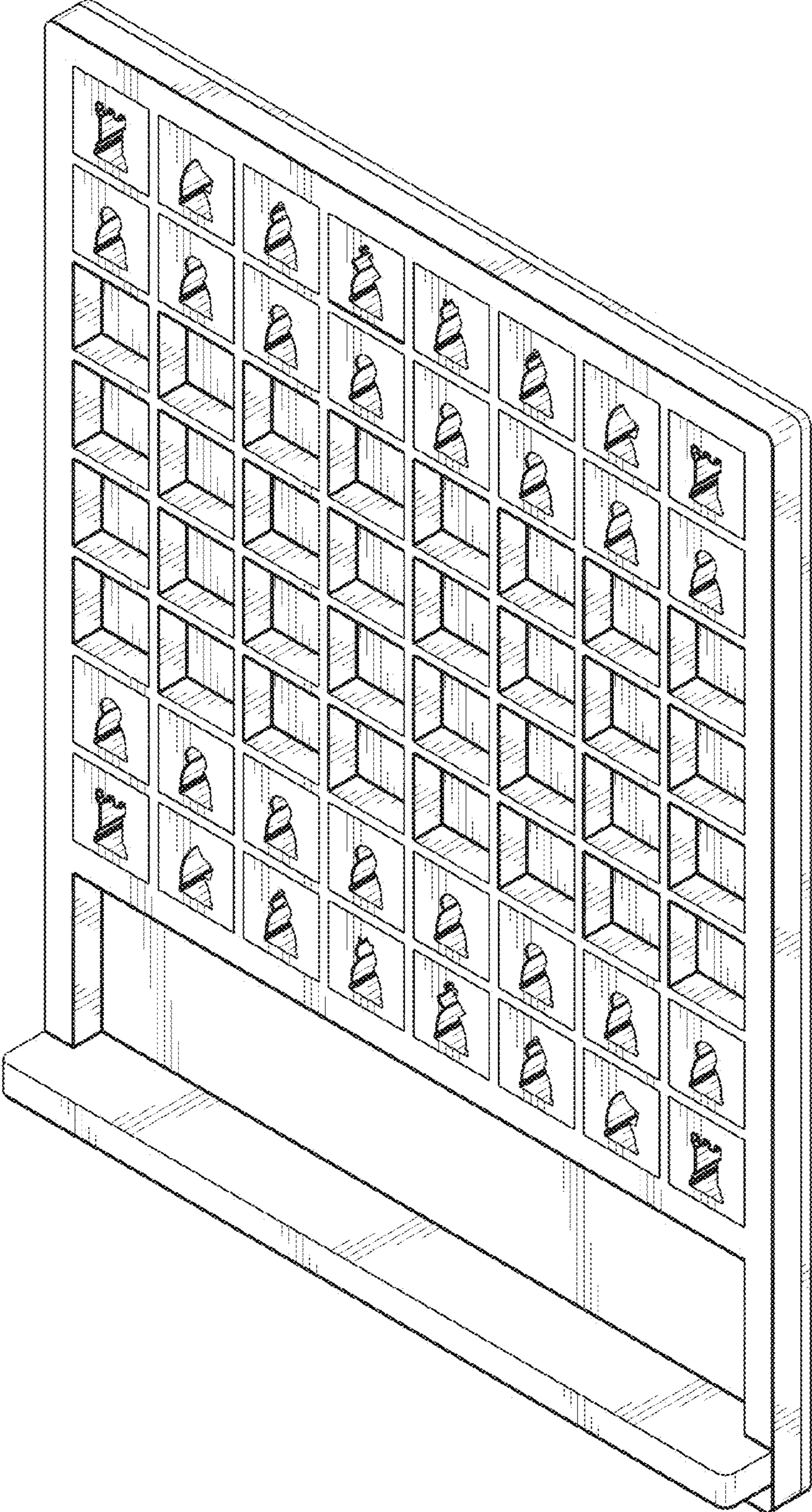

FIG. 1

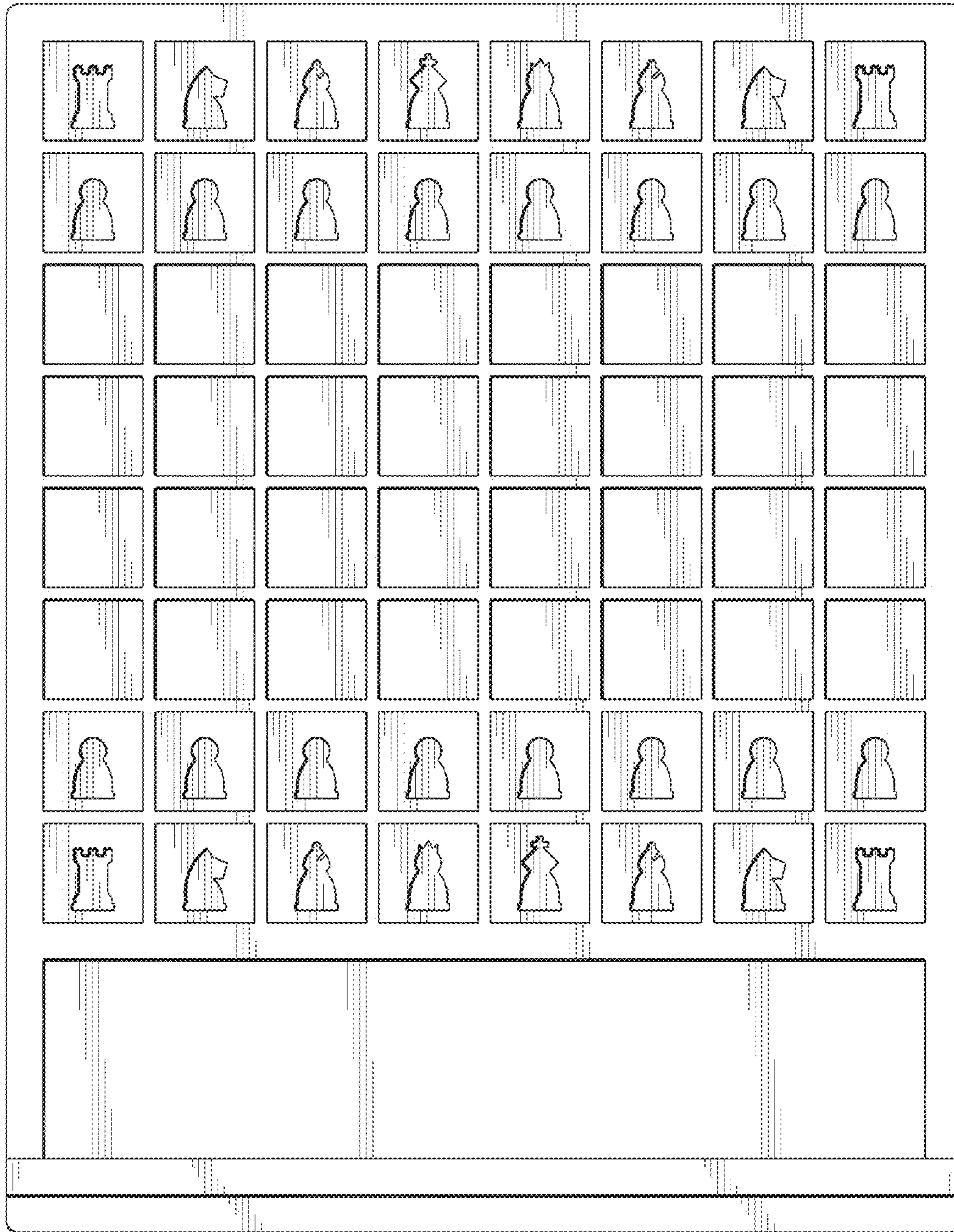

FIG. 2

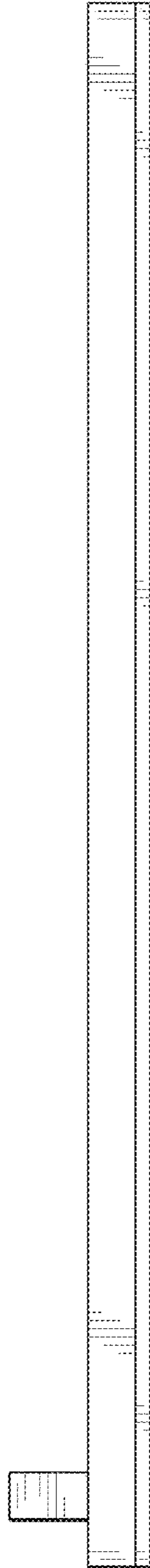

FIG. 3

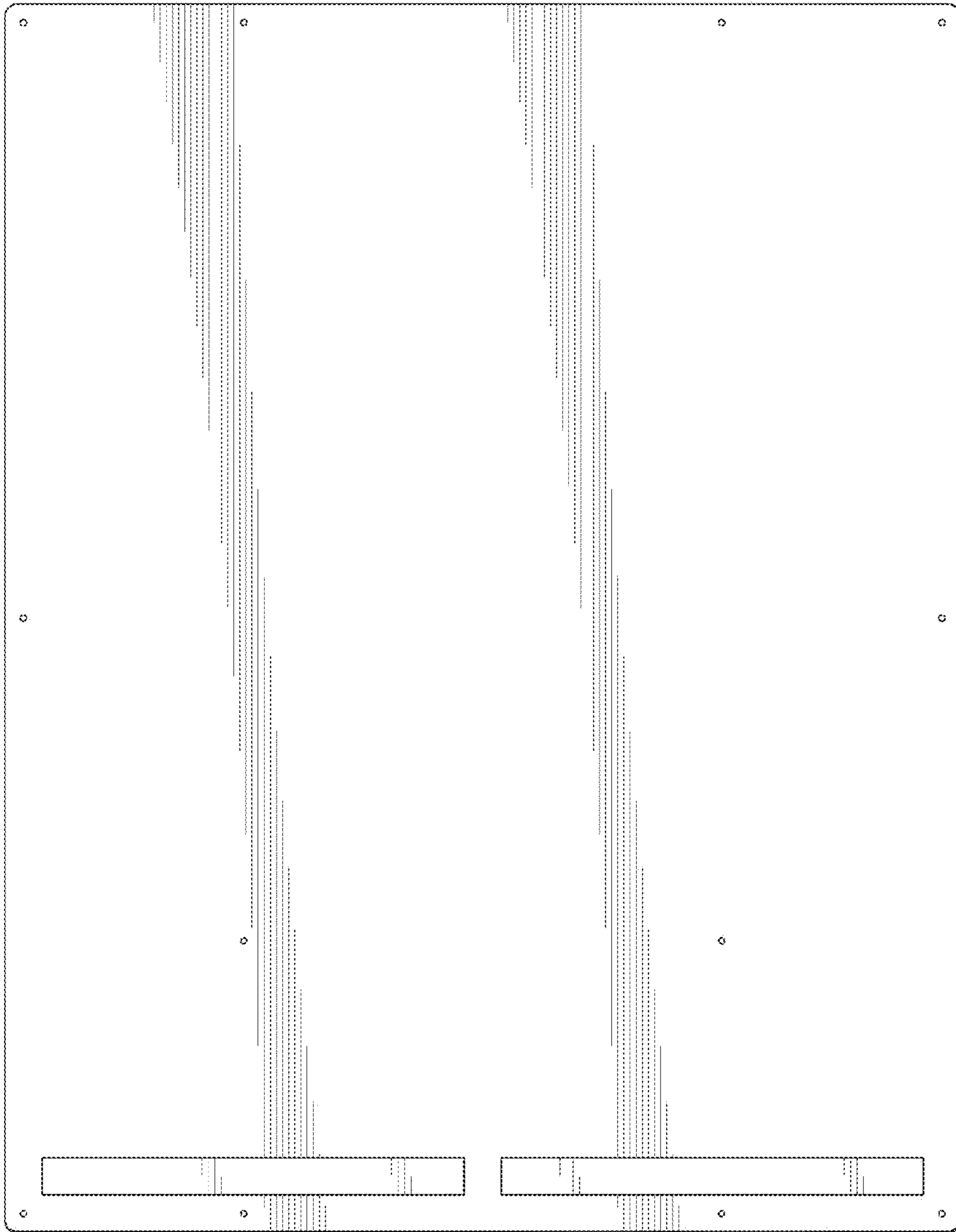

FIG. 4

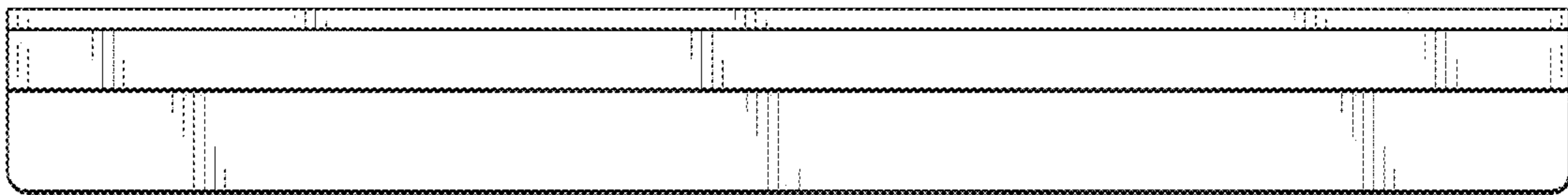

FIG. 5

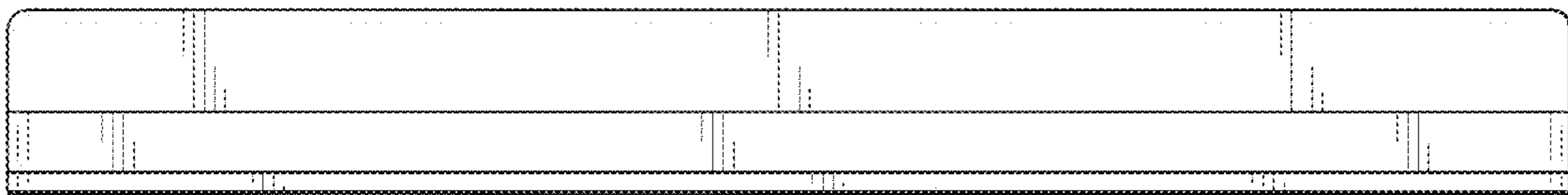

FIG. 6

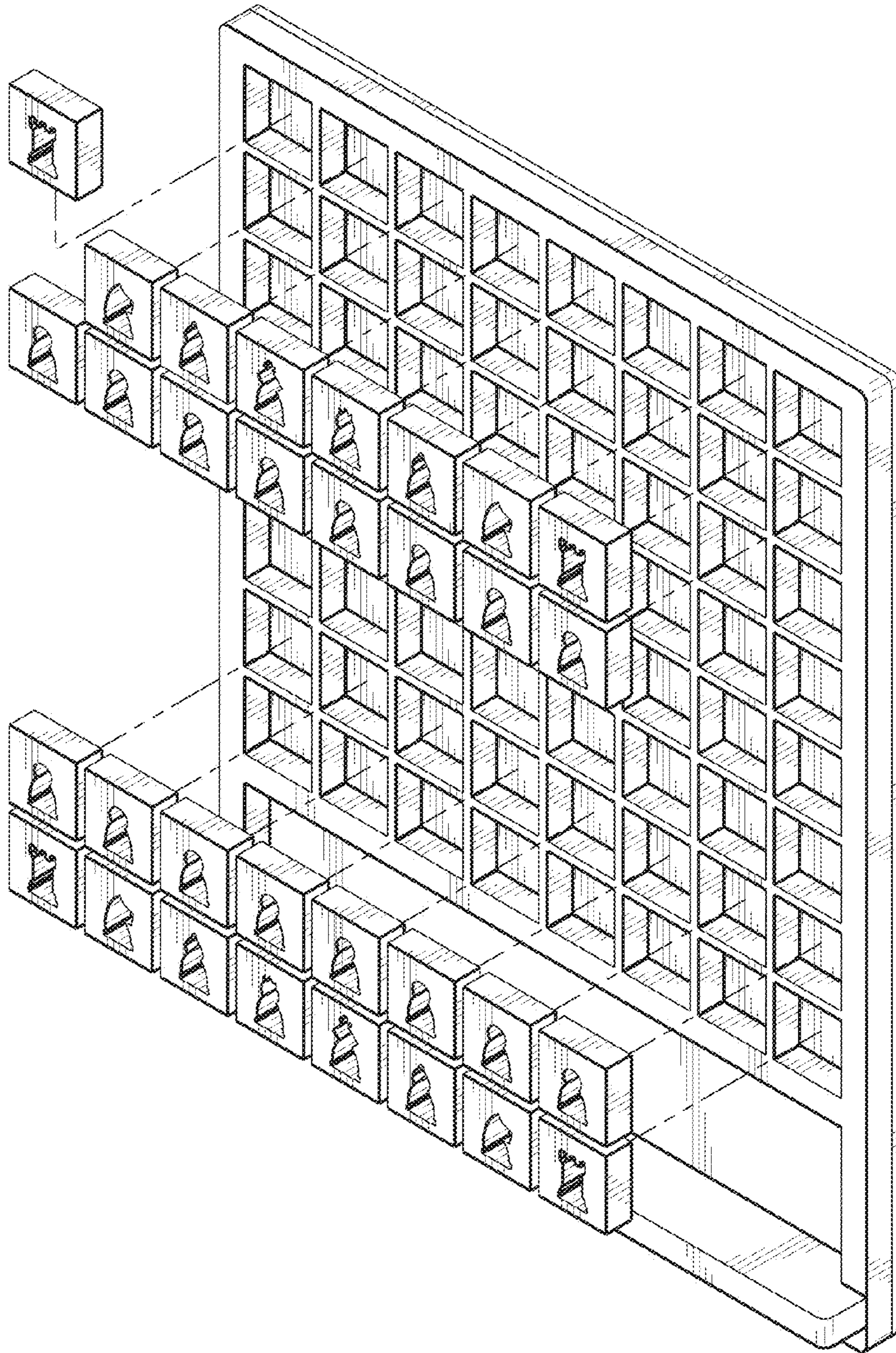

FIG. 7