



US00D759755S

(12) **United States Design Patent**  
**Busch**

(10) **Patent No.:** **US D759,755 S**  
(45) **Date of Patent:** **\*\* Jun. 21, 2016**

(54) **POCKET KEY ORGANIZER**

- (71) Applicant: **BladeKey LLC**, Tempe, AZ (US)
- (72) Inventor: **James David Busch**, Tempe, AZ (US)
- (73) Assignee: **BladeKey LLC**, Tempe, AZ (US)
- (\*\*) Term: **14 Years**
- (21) Appl. No.: **29/522,662**
- (22) Filed: **Apr. 1, 2015**

**Related U.S. Application Data**

- (63) Continuation of application No. 29/502,498, filed on Sep. 17, 2014, which is a continuation-in-part of  
(Continued)
- (51) **LOC (10) Cl.** ..... **19-06**
- (52) **U.S. Cl.**  
USPC ..... **D19/121; D19/157; D3/207; D8/43**
- (58) **Field of Classification Search**  
USPC ..... D11/1-2, 14, 26-29, 89-92, 44, 48, 81,  
D11/99; 63/26-28, 32; D3/207-212; D8/43;  
70/456 B, 408, 457, 458, 456 R;  
206/37.1; D10/64; D19/121, 135, 157,  
D19/81, 83, 84, 98, 123; 24/3.6  
CPC ..... A46B 5/02; G06F 3/033; G06F 3/041;  
G08C 21/00; A44B 15/00  
See application file for complete search history.

(56) **References Cited**

**U.S. PATENT DOCUMENTS**

D3,942 S	3/1870	Elwell
1,728,128 A	9/1929	Kodama

(Continued)

**FOREIGN PATENT DOCUMENTS**

CN	2691863	4/2005
CN	201131411	10/2008

(Continued)

**OTHER PUBLICATIONS**

Ethanf, "Do you hate your keys jingling? (Bicycle Content)," EDCForums (Sep. 12, 2011).

(Continued)

*Primary Examiner* — Ralf Seifert

(74) *Attorney, Agent, or Firm* — James David Busch

(57) **CLAIM**

I claim the ornamental design for a pocket key organizer, substantially as shown and described.

**DESCRIPTION**

FIG. 1 is a front perspective view of the pocket key organizer; FIG. 2 is a front view of FIG. 1; FIG. 3 is a rear view of FIG. 1; FIG. 4 is a left side view of FIG. 1; FIG. 5 is a right side view of FIG. 1; FIG. 6 is a top view of FIG. 1; FIG. 7 is a bottom view of FIG. 1; FIG. 8 is a front perspective view of a second embodiment of the pocket key organizer; FIG. 9 is a front view of FIG. 8; FIG. 10 is a rear view of FIG. 8; FIG. 11 is a left side view of FIG. 8; FIG. 12 is a right side view of FIG. 8; FIG. 13 is a top view of FIG. 8; FIG. 14 is a bottom view of FIG. 8; FIG. 15 is a front perspective view of a third embodiment of the pocket key organizer; FIG. 16 is a front view of FIG. 15; FIG. 17 is a rear view of FIG. 15; FIG. 18 is a left side view of FIG. 15; FIG. 19 is a right side view of FIG. 15; FIG. 20 is a top view of FIG. 15; FIG. 21 is a bottom view of FIG. 15; FIG. 22 is a left side view of any of the embodiments shown in a position of use with a key; and, FIG. 23 is a left side view of any of the embodiments shown in a position of use with a key rotated ninety degrees clockwise.

The features shown in broken lines in the various Figures are for illustrating the environmental structure and form no part of the claimed design.

**1 Claim, 7 Drawing Sheets**

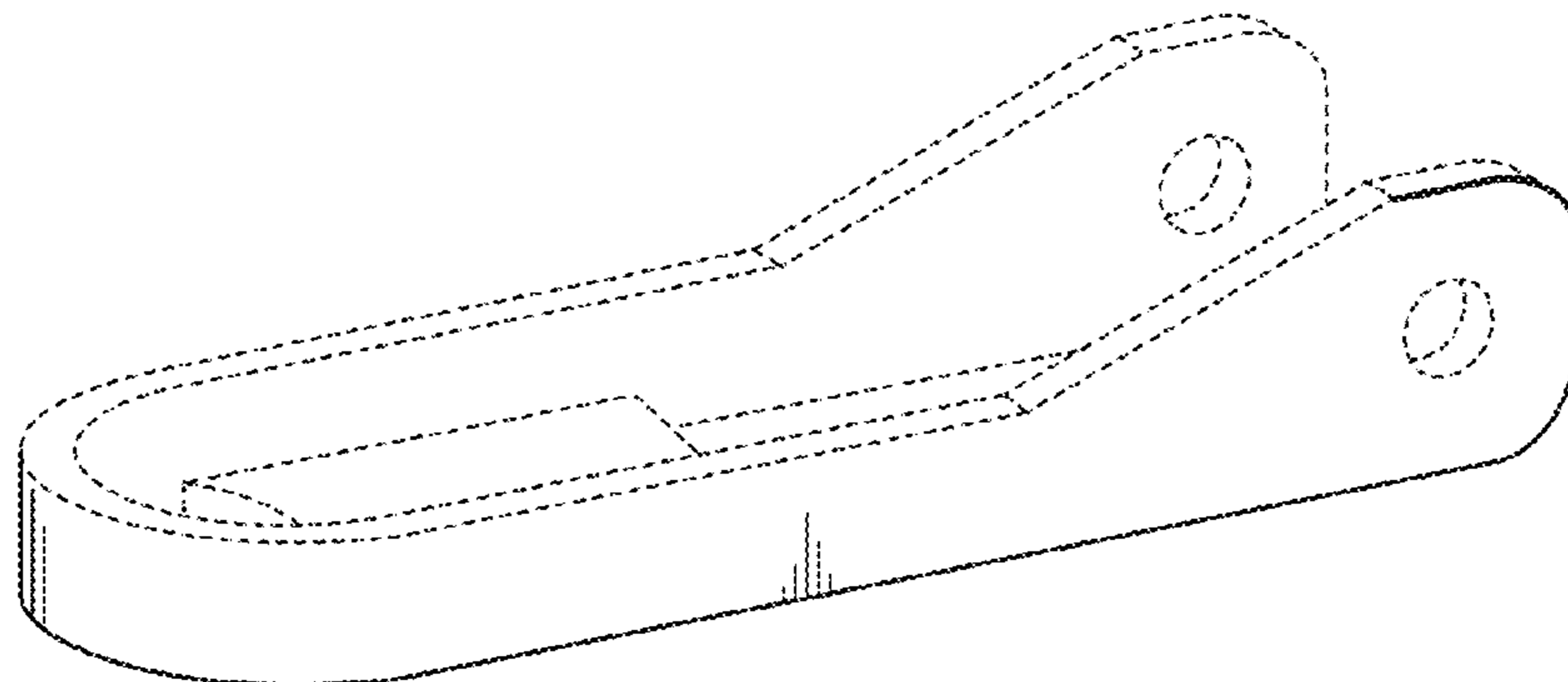

**Related U.S. Application Data**

application No. 29/457,348, filed on Jun. 9, 2013, now Pat. No. Des. 714,537, which is a continuation-in-part of application No. 29/438,466, filed on Nov. 30, 2012, now Pat. No. Des. 683,951, which is a continuation of application No. 29/406,366, filed on Nov. 13, 2011, now Pat. No. Des. 674,590.

(56)

**References Cited**

U.S. PATENT DOCUMENTS

1,885,957 A 11/1932 Singleton  
 1,909,735 A \* 5/1933 Vavrosky ..... A44B 15/00  
 24/3.6  
 1,922,755 A 8/1933 Buxton  
 2,038,070 A 4/1936 Welch  
 2,228,726 A 1/1941 Loesch  
 D133,144 S \* 7/1942 Struble ..... 24/3.6  
 2,344,581 A 3/1944 Ziegeweid  
 D156,677 S 5/1948 Smith  
 2,482,623 A 9/1949 Kaminer  
 2,514,940 A 7/1950 Hogue  
 2,547,340 A 4/1951 Mullan  
 2,547,524 A 4/1951 Gross  
 2,583,961 A 1/1952 Nash  
 2,600,749 A 6/1952 Gallagher  
 2,625,814 A 1/1953 Mullan  
 2,637,994 A 5/1953 Harrison  
 2,659,231 A 11/1953 Glubiak  
 D172,355 S 6/1954 Zimmer  
 2,699,667 A 1/1955 Mark  
 2,836,053 A 5/1958 Starreit  
 2,869,232 A 1/1959 Kivela  
 2,882,710 A 4/1959 Furn  
 D185,686 S 7/1959 Tronson  
 2,931,208 A 4/1960 Prim  
 2,964,937 A 12/1960 Lauffin  
 2,969,668 A 1/1961 Aitchison  
 2,978,897 A 4/1961 Capitani  
 2,989,861 A 6/1961 Schefman  
 3,004,422 A 10/1961 Starrett  
 D198,910 S 8/1964 Stolarz  
 3,277,680 A 10/1966 Merila  
 3,299,930 A 1/1967 Schumer  
 D206,875 S 2/1967 Mosch  
 3,355,917 A 12/1967 Albert  
 3,363,440 A 1/1968 Rivers  
 3,394,565 A 7/1968 Turman  
 3,407,021 A 10/1968 Mosch  
 3,407,636 A 10/1968 Kovacevic  
 3,421,349 A 1/1969 St. Clair  
 3,455,131 A 7/1969 Shofner  
 3,527,072 A 9/1970 Demetreon  
 3,606,777 A 9/1971 Watson  
 3,672,192 A 6/1972 Dontas  
 3,677,044 A 7/1972 De Frees  
 3,696,649 A 10/1972 Chow et al.  
 3,882,702 A 5/1975 Wiczner  
 D237,561 S 11/1975 Kesner  
 3,931,688 A 1/1976 Owens  
 D248,960 S 8/1978 Iverson  
 4,149,812 A 4/1979 Huffman, Jr.  
 4,253,321 A \* 3/1981 Sorensen ..... A45C 11/324  
 70/456 R  
 4,297,864 A 11/1981 Beier  
 4,351,173 A 9/1982 Toyoda  
 4,417,612 A 11/1983 Couture et al.  
 4,454,737 A 6/1984 Toyoda  
 4,524,594 A 6/1985 Bascou  
 4,549,827 A 10/1985 Mack  
 4,569,215 A 2/1986 McCarthy  
 4,571,967 A 2/1986 Jacobsen  
 4,658,479 A 4/1987 Sanders  
 4,901,547 A 2/1990 Dal Palu'  
 4,939,917 A 7/1990 Cartwright  
 4,941,569 A 7/1990 Lindmayer et al.

D310,101 S 8/1990 Gauthier  
 4,951,489 A 8/1990 Proch  
 D310,449 S 9/1990 Agrippino  
 5,117,666 A \* 6/1992 Keefer ..... A45C 11/321  
 70/456 R  
 D332,384 S 1/1993 Dague  
 D334,528 S 4/1993 Franklin  
 5,199,560 A 4/1993 Lee et al.  
 5,207,082 A 5/1993 LeMaitre  
 D356,019 S 3/1995 Sakai  
 D357,166 S 4/1995 Concari  
 5,460,022 A 10/1995 Parsons  
 D364,269 S 11/1995 Sabosky  
 5,544,510 A 8/1996 Botteon et al.  
 5,568,741 A 10/1996 Parsons  
 D382,190 S 8/1997 Blackston et al.  
 D385,301 S 10/1997 Wang  
 5,704,235 A 1/1998 Stahle  
 5,704,236 A 1/1998 Parsons  
 5,711,194 A 1/1998 Anderson  
 5,732,579 A 3/1998 D'Hont et al.  
 5,768,925 A 6/1998 Ozawa et al.  
 5,791,211 A 8/1998 Bondhus et al.  
 D402,459 S 12/1998 Steinmacher  
 D404,284 S 1/1999 Sacco et al.  
 D405,675 S 2/1999 Rivera  
 D405,953 S 2/1999 Legg  
 D415,343 S 10/1999 Maddox  
 6,016,676 A 1/2000 McConnell  
 D423,209 S 4/2000 Guyot  
 D427,501 S 7/2000 Berg et al.  
 6,106,131 A 8/2000 Hao  
 D434,302 S 11/2000 Van Den Acker  
 6,164,102 A 12/2000 Gapco  
 D442,060 S 5/2001 Neset  
 D442,061 S 5/2001 Harris et al.  
 D442,466 S 5/2001 Van Den Acker  
 D444,502 S 7/2001 Luntz  
 6,282,996 B1 9/2001 Berg et al.  
 6,464,419 B1 10/2002 Chan  
 D469,806 S 2/2003 Chan  
 D473,710 S 4/2003 Szilva  
 D478,207 S 8/2003 Johnson  
 D485,297 S 1/2004 Reda et al.  
 6,684,673 B2 2/2004 Florendo  
 6,763,938 B1 7/2004 Nelson  
 D498,259 S 11/2004 Kung et al.  
 D499,764 S 12/2004 Arnold  
 6,892,558 B2 5/2005 Chodosh  
 D509,538 S 9/2005 Yeh  
 D514,310 S 2/2006 Roye  
 7,032,419 B2 4/2006 Booker  
 D528,163 S 9/2006 Mandel  
 7,125,186 B1 10/2006 Stokes  
 7,127,922 B2 10/2006 Khounsombath et al.  
 D539,526 S 4/2007 Stein  
 D579,494 S 10/2008 Chan et al.  
 D593,318 S 6/2009 Kelleghan  
 D624,305 S 9/2010 Downes  
 D626,590 S 11/2010 Pugilisi  
 8,182,166 B2 5/2012 Colman  
 D665,992 S 8/2012 Wilbur  
 D674,590 S 1/2013 Busch  
 D683,951 S 6/2013 Busch  
 8,493,369 B2 7/2013 Liang et al.  
 D693,202 S 11/2013 Berman  
 D705,533 S 5/2014 Tunney  
 D709,344 S 7/2014 Adelman et al.  
 D714,537 S 10/2014 Busch  
 D714,539 S 10/2014 Busch

FOREIGN PATENT DOCUMENTS

CN 201494157 6/2010  
 CN 201552879 8/2010

(56)

**References Cited**

FOREIGN PATENT DOCUMENTS

CN	202782316	3/2013
CN	203077923	7/2013

OTHER PUBLICATIONS

Anonymous, "Products," Down Home Leather, Nov. 24, 2011.  
 Anonymous, "Novel Key Holder," Popular Mechanics at p. 161 (Jan. 1923).  
 Anonymous, "Key & Holders," Able Home Aides (Nov. 24, 2011).  
 Crew, "My new custom 'multi-key', made from a Gerber Curve!" EDCForums (Dec. 1, 2010).  
 LEGOMAN0721, "Cold Steel Mini Tac Tanto," EDCForums (Nov. 24, 2010).  
 Aphi, "Switchkey," EDCForums (Dec. 19, 2010).  
 Shadeone, "The Real Leatherman KEYman! My custom Multi-Key!!," EDCForums (Aug. 6, 2007).  
 Anonymous, "Master Key Set," T-Parts (Date Unknown).  
 Anonymous, "True Utility® Keyring System," True Utility (Date Unknown).  
 Dieck, "Ultra Ultra minimalist keyring," EDCForums (May 29, 2008).  
 Diaz, Oscar, "While u sleep," Oscar Diaz Studio (Date Unknown).  
 Wild Style, "wild style's daily carry," EDCForums (Oct. 21, 2009).  
 Anonymous, "Carrying Keys," Carryology (Jun. 3, 2010).

Busch, "Photo Set 1," (Jul. 8, 2007).  
 Busch, "Photo Set 2," (Jul. 8, 2007).  
 F3RG, "Crank Bros. Folding Keychain," Mtbr Forums (Jan. 29, 2009).  
 Anonymous, "Photo Of Keys" (Date Unknown).  
 PYRO222, "Multi-tool Keys—Mod / Hack," Instructables (Jul. 20, 2008).  
 Anonymous, "Compact Key Chain," Sagawisiw (Jun. 10, 2012).  
 Lota, Jon, "KeyFlip," Kickstarter.com (Jan. 25, 2013) (printed Jun. 9, 2013).  
 Tunney, Michael Patrick, "SmartKey," Kickstarter.com (May 5, 2013) (printed Jun. 9, 2013).  
 Anonymous, "nail-file-pen," Halsun International (Date Unknown) (printed Apr. 21, 2014).  
 Anonymous, "Signature Item No. 54104," Victorinox (Date Unknown) (printed Apr. 21, 2014).  
 Anonymous, "Retractable Pen Refill Item No. 30459," Victorinox (Date Unknown) (printed Apr. 21, 2014).  
 Anonymous, "Ballpoint Pen, Large Item No. 30422," Victorinox (Date Unknown) (printed Apr. 21, 2014).  
 Anonymous, "Ballpoint Pen, Large Item No. 30422," Victorinox (Date Unknown) (printed Apr. 22, 2014).  
 The D180 Folding Pen, Unknown 3D Printed Concepts of Mississauga, Canada.

\* cited by examiner

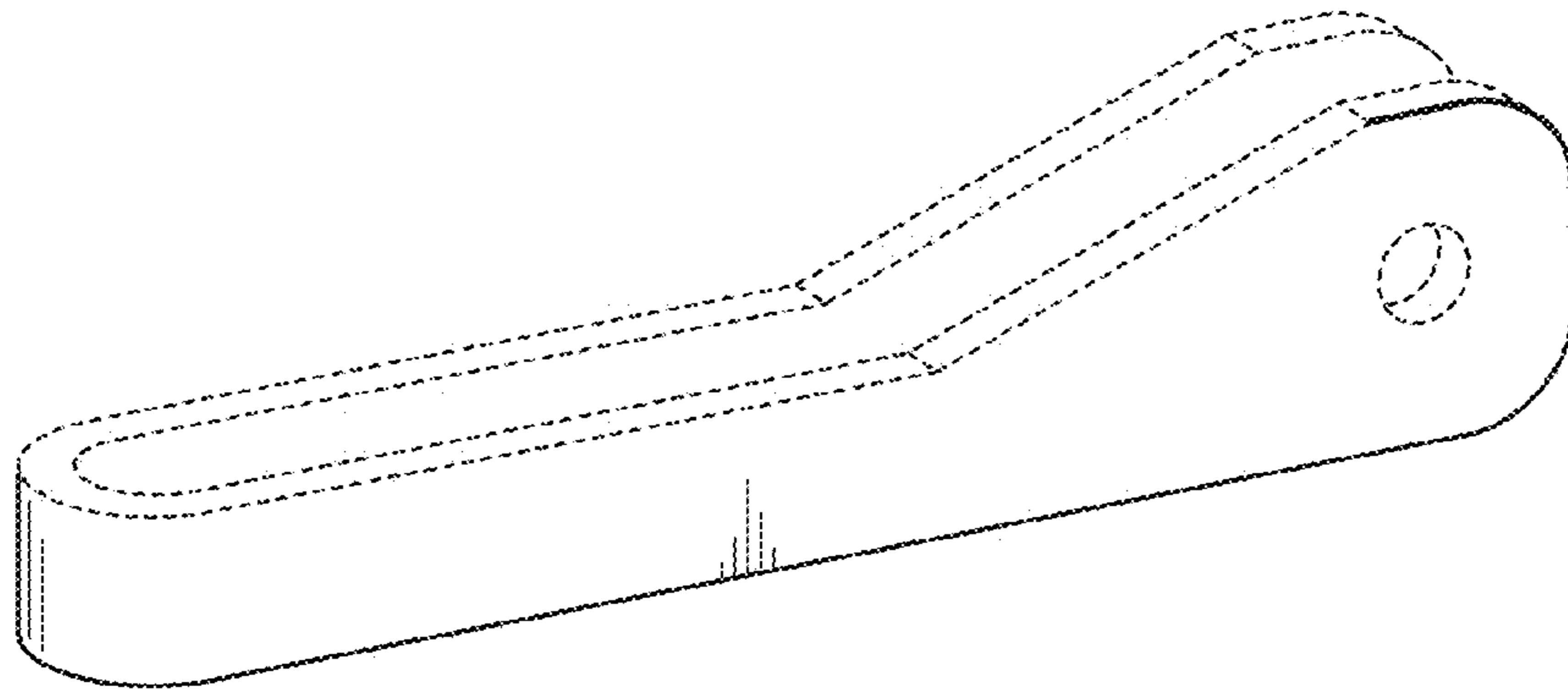

FIG. 1

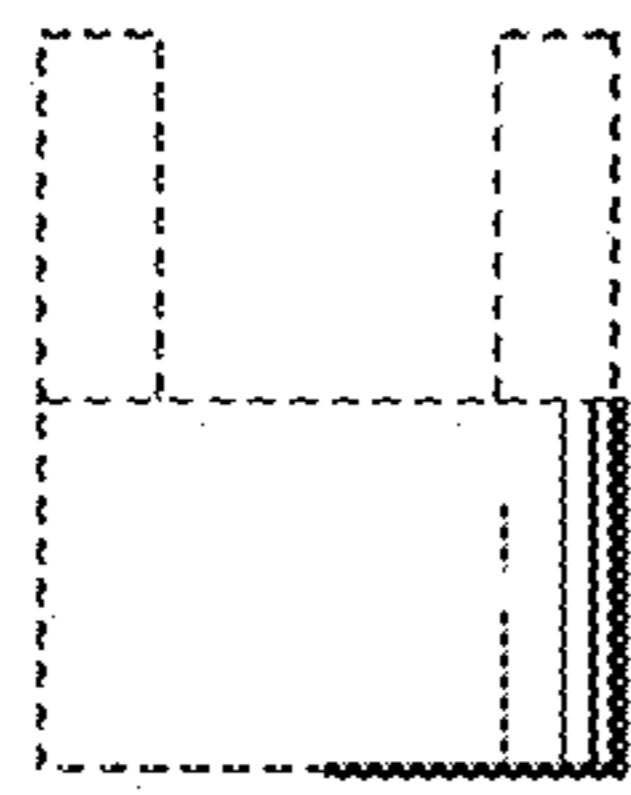

FIG. 2

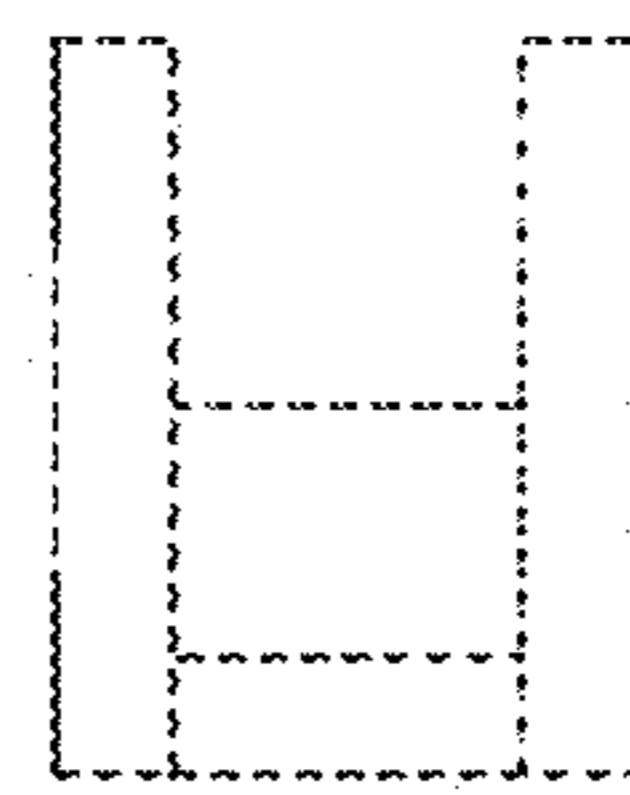

FIG. 3

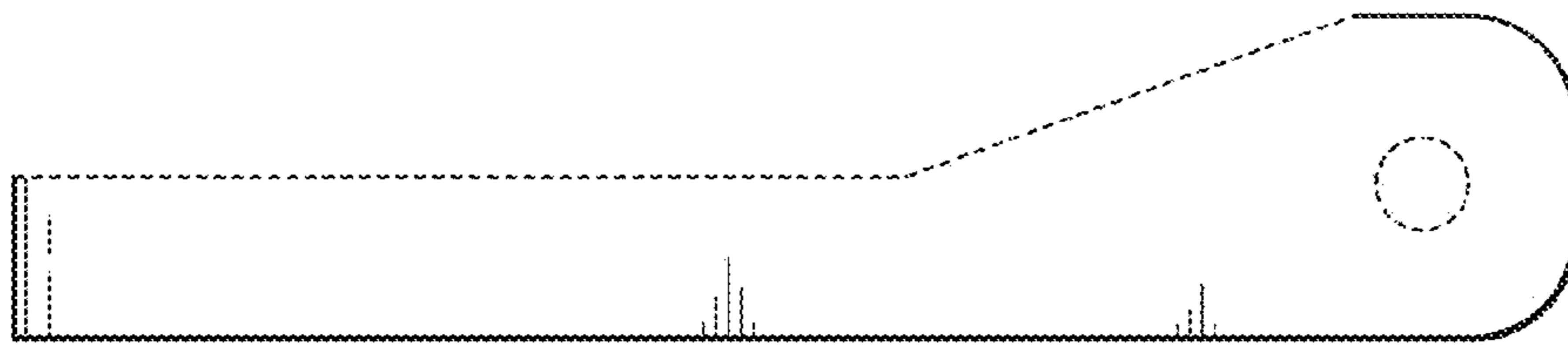

FIG. 4

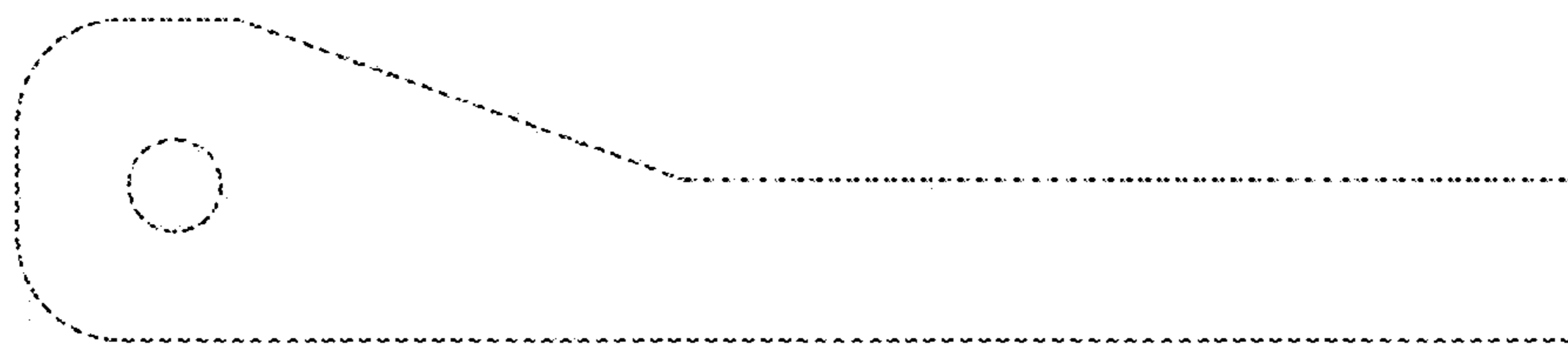

FIG. 5

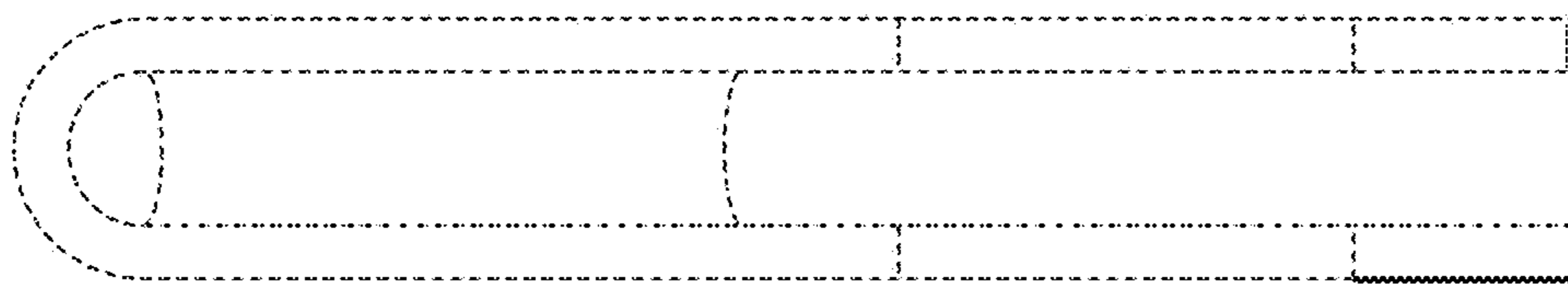

FIG. 6

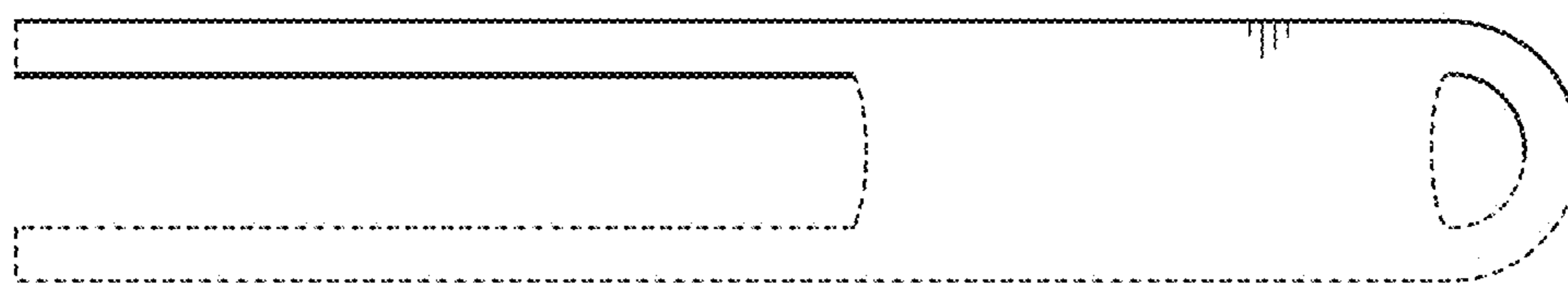

FIG. 7

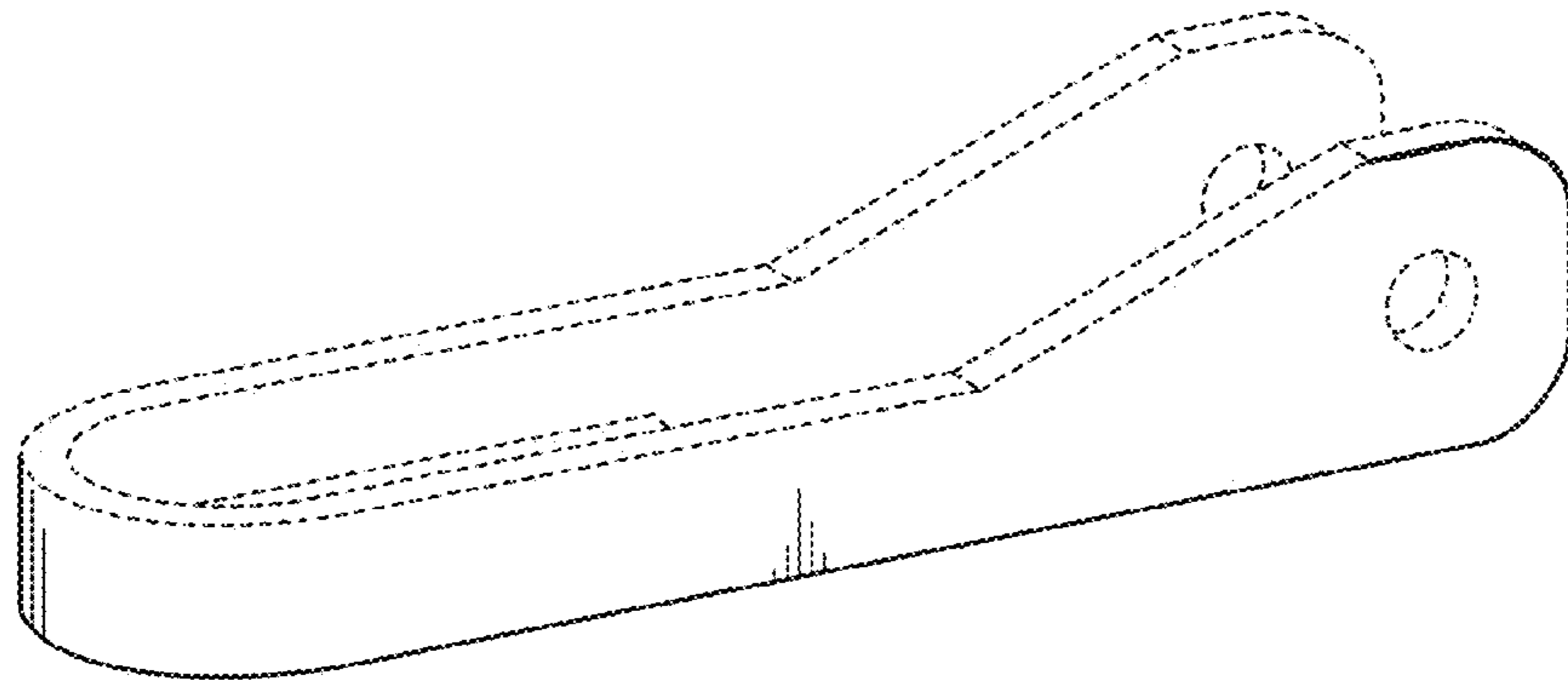

FIG. 8

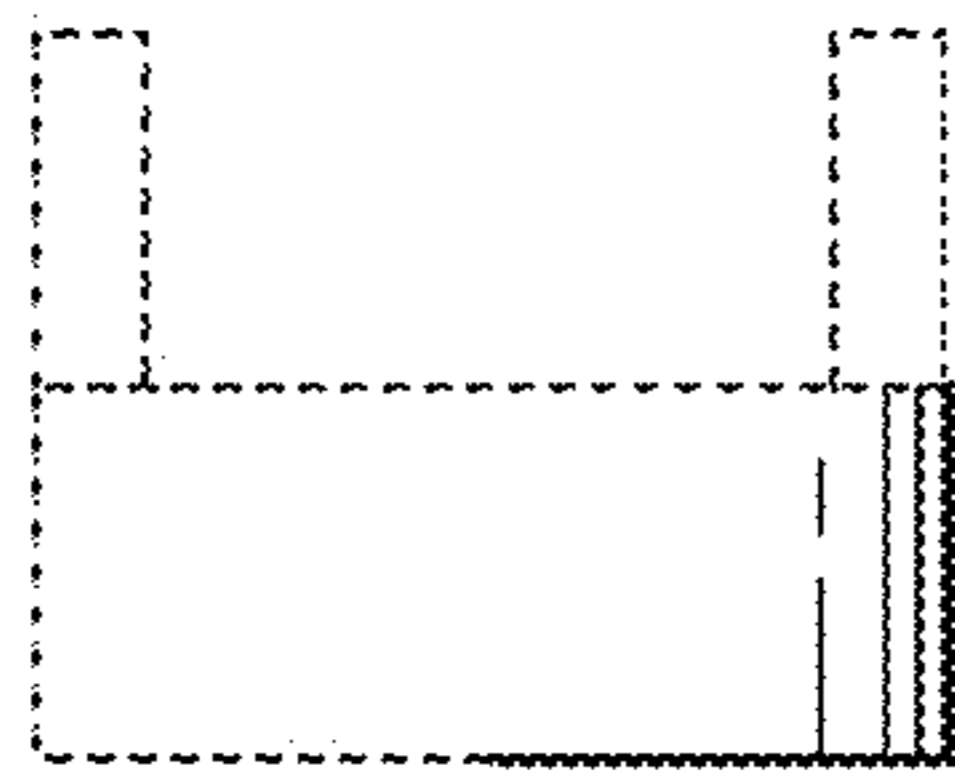

FIG. 9

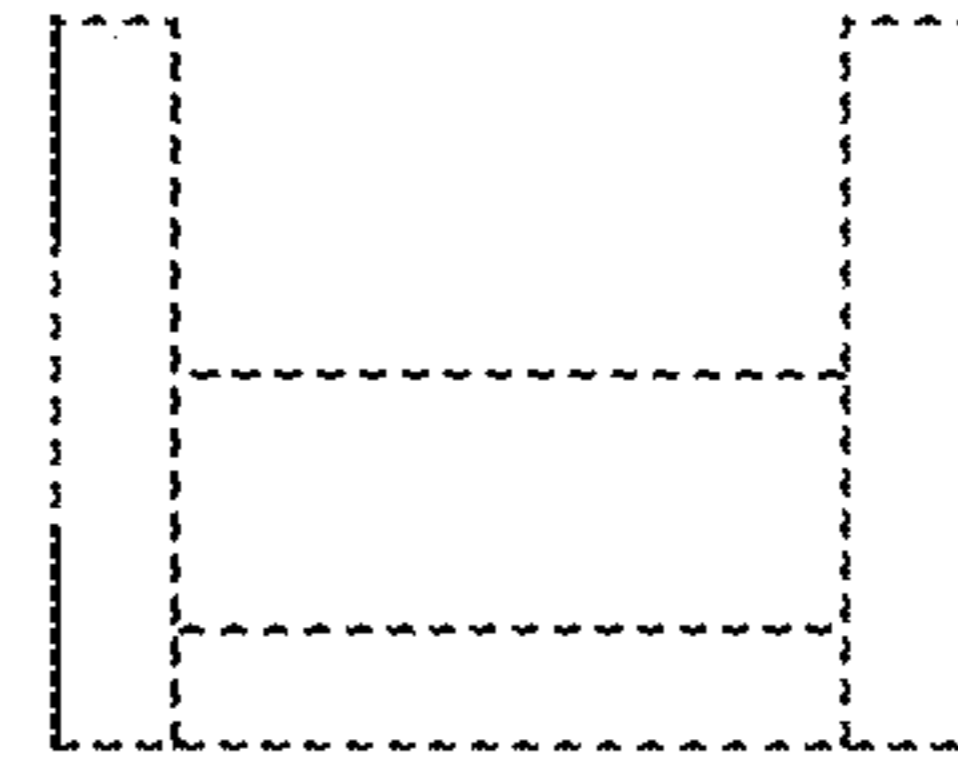

FIG. 10

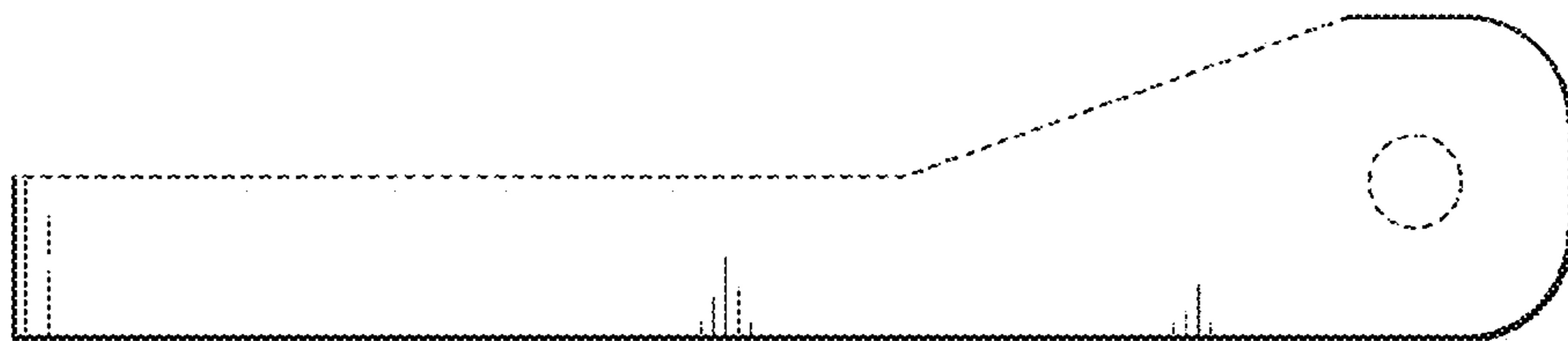

FIG. 11

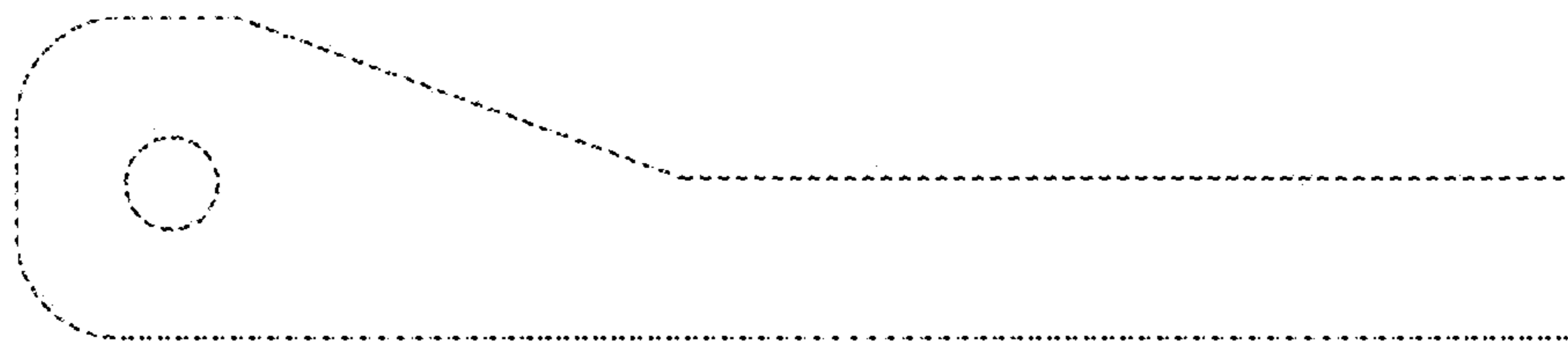

FIG. 12

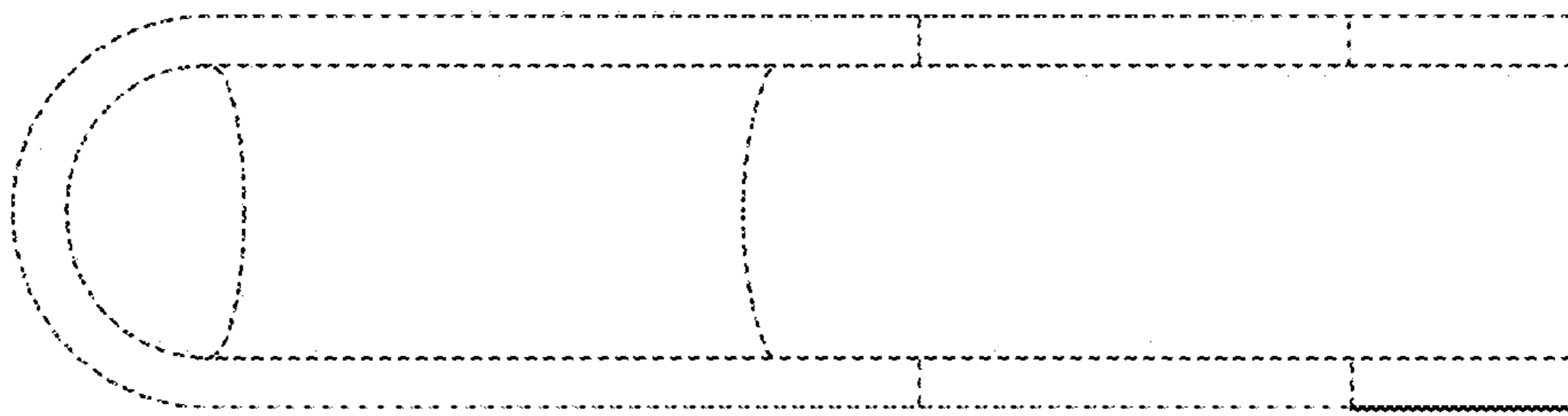

FIG. 13

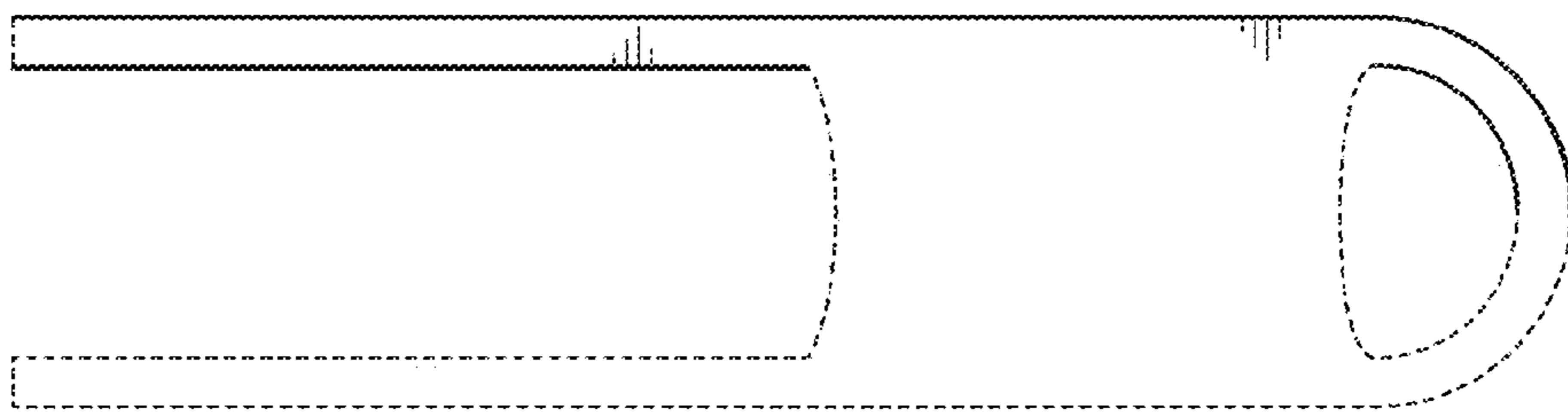

FIG. 14

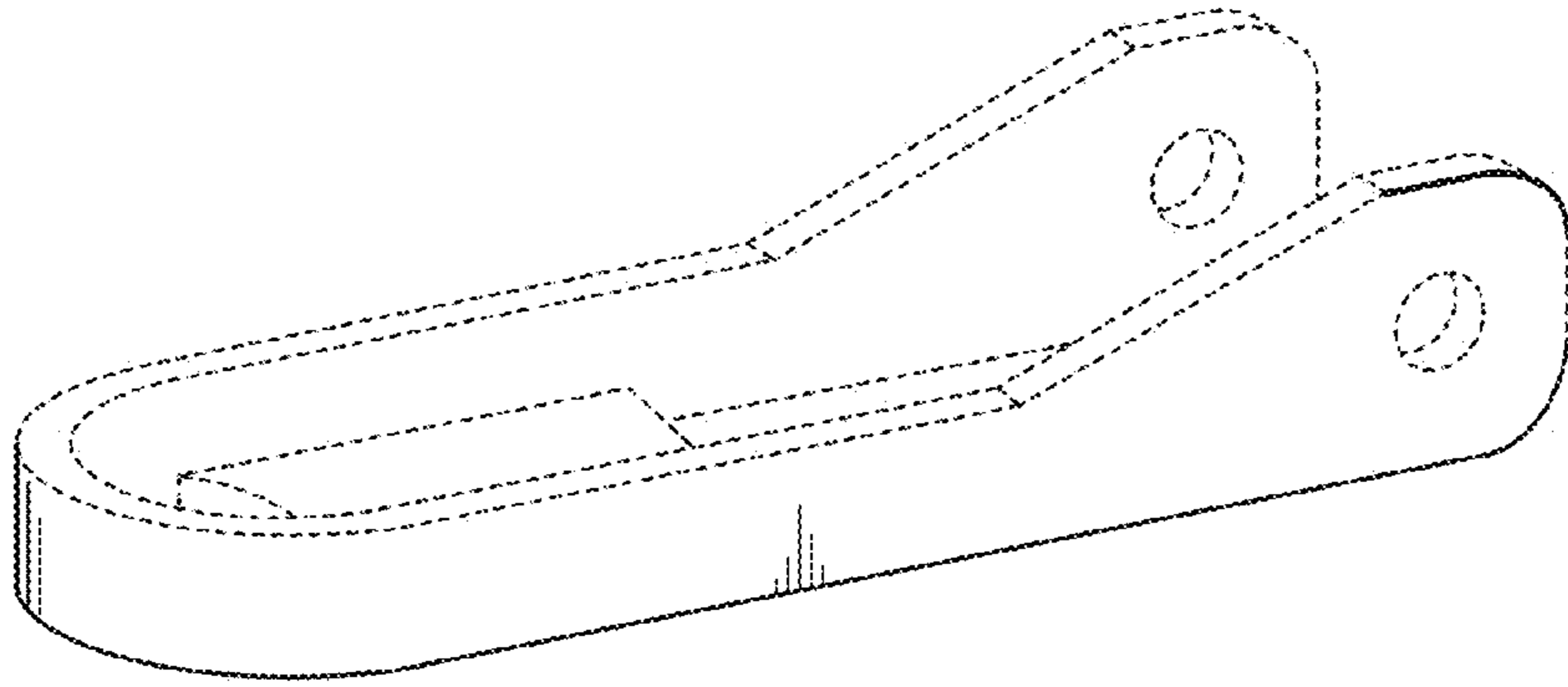

FIG. 15

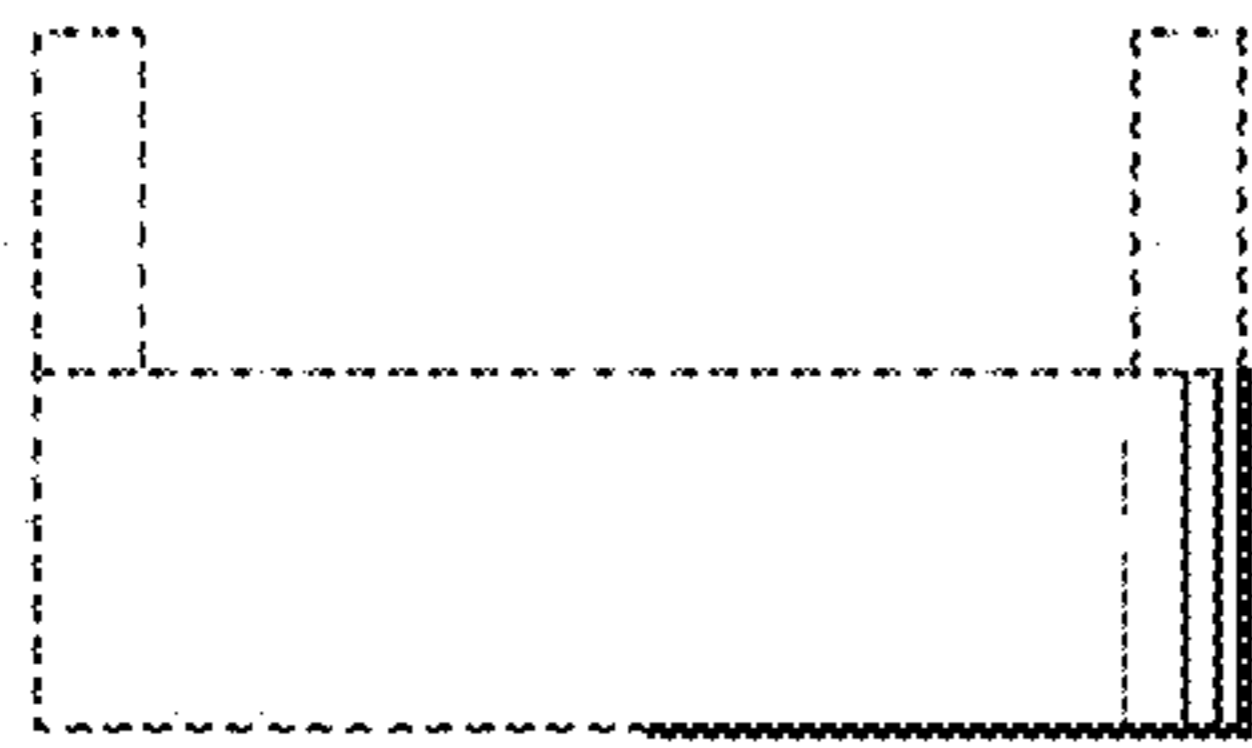

FIG. 16

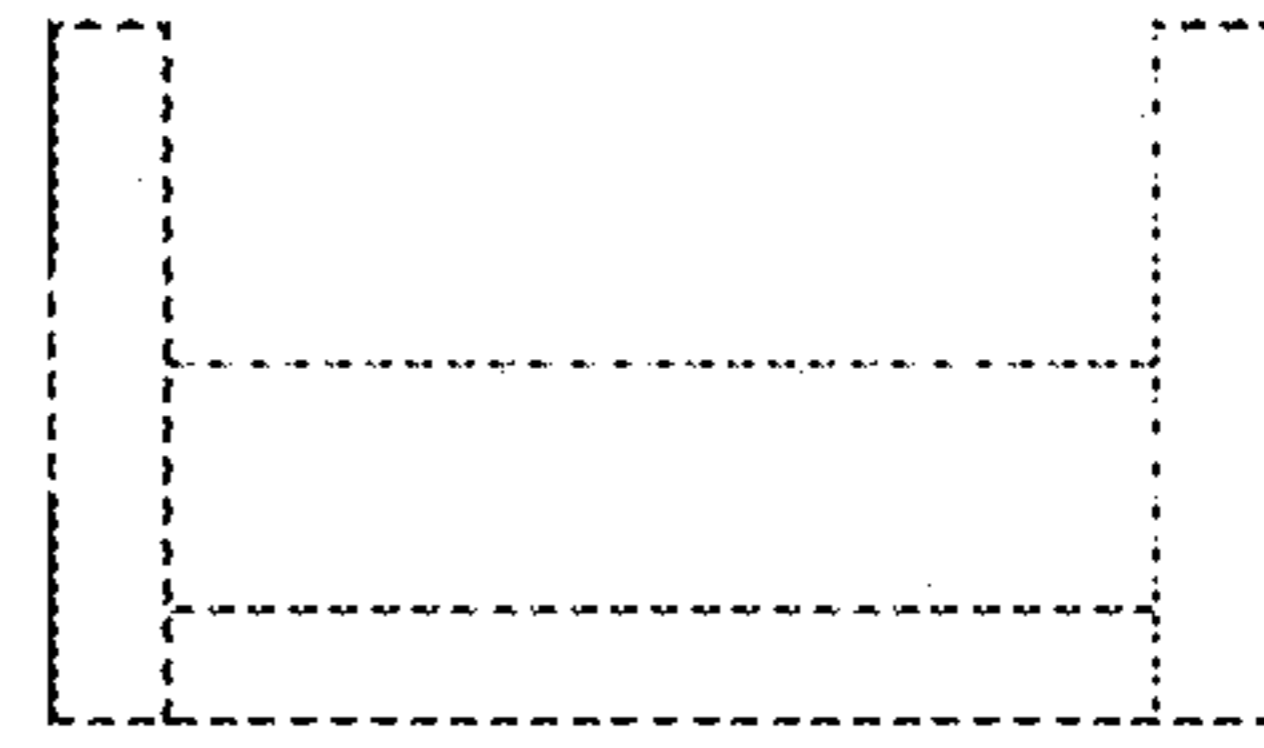

FIG. 17

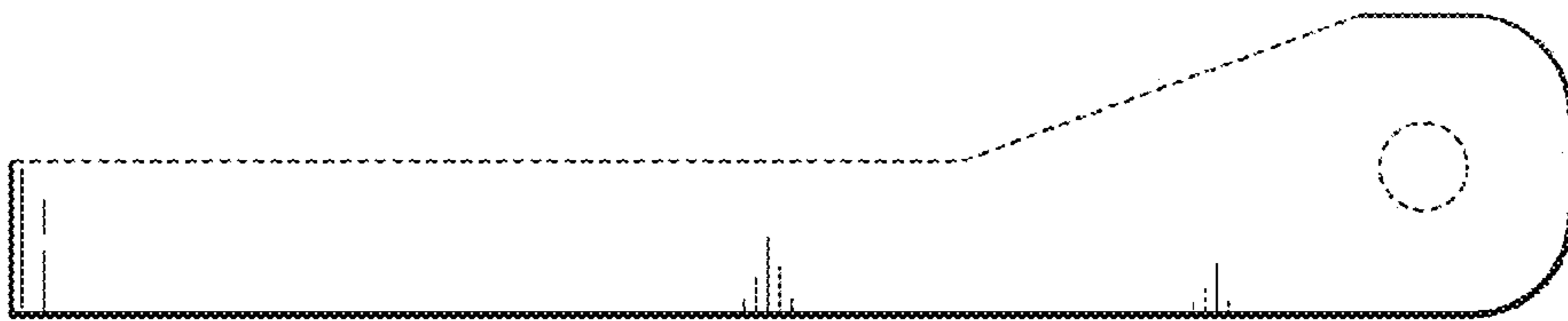

FIG. 18

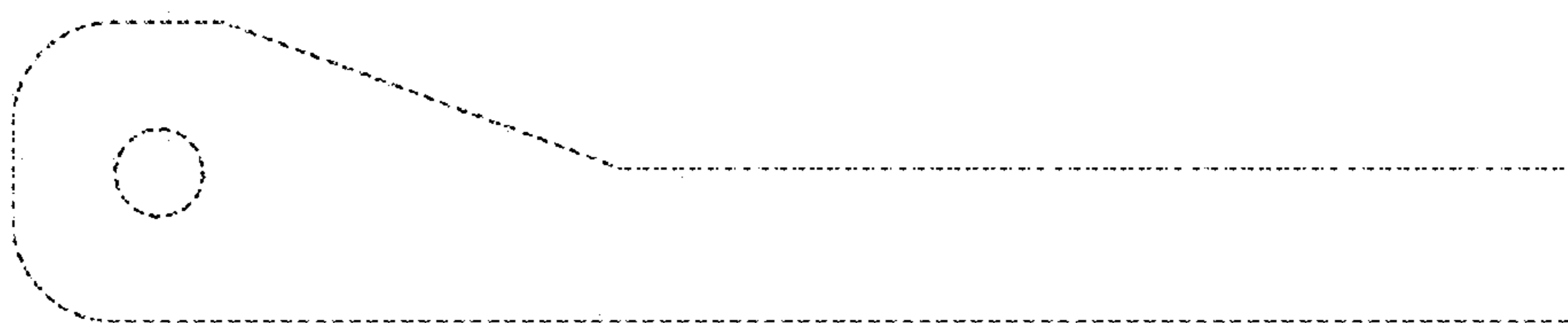

FIG. 19



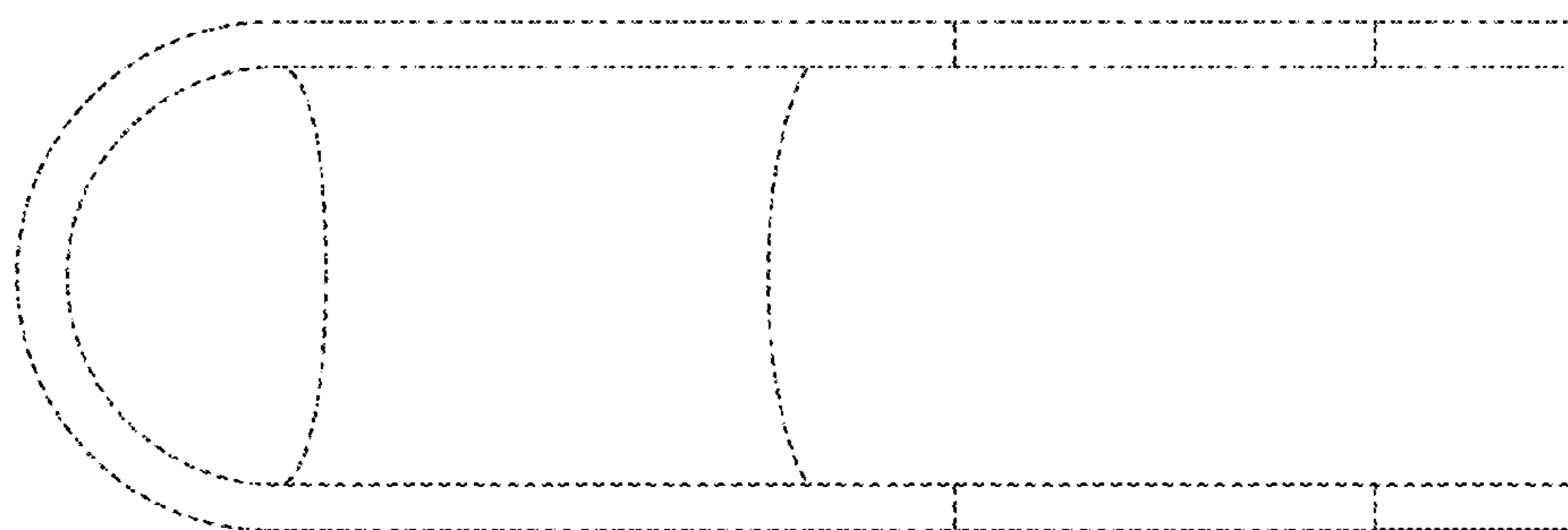

FIG. 20

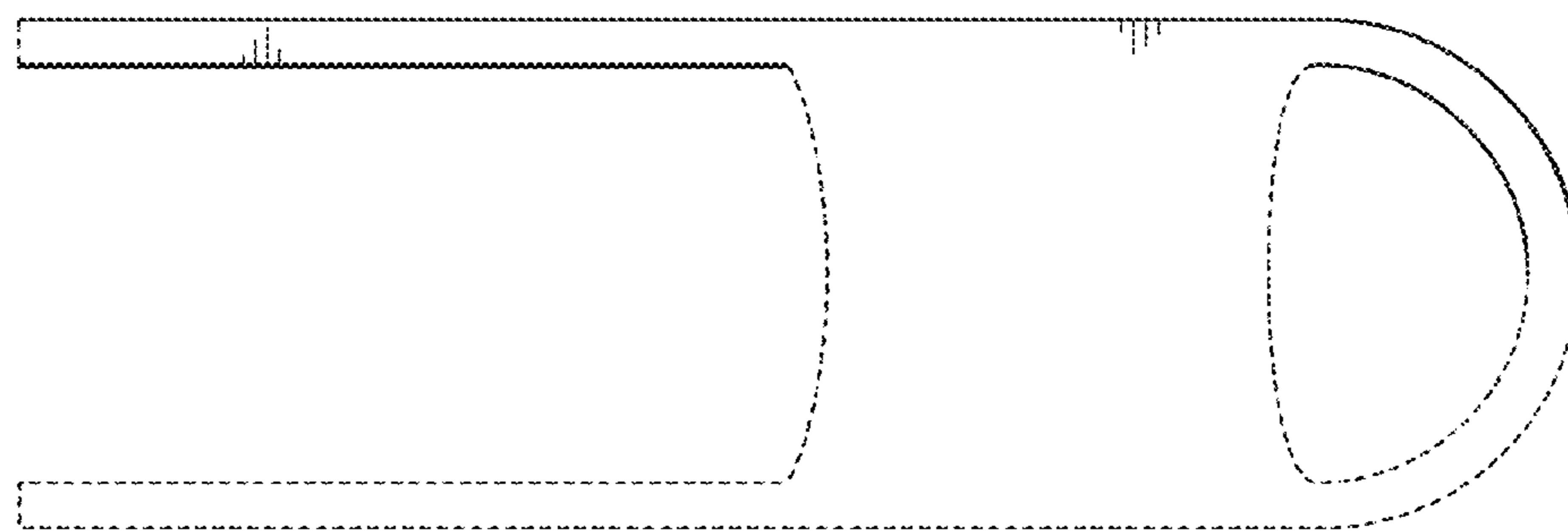

FIG. 21

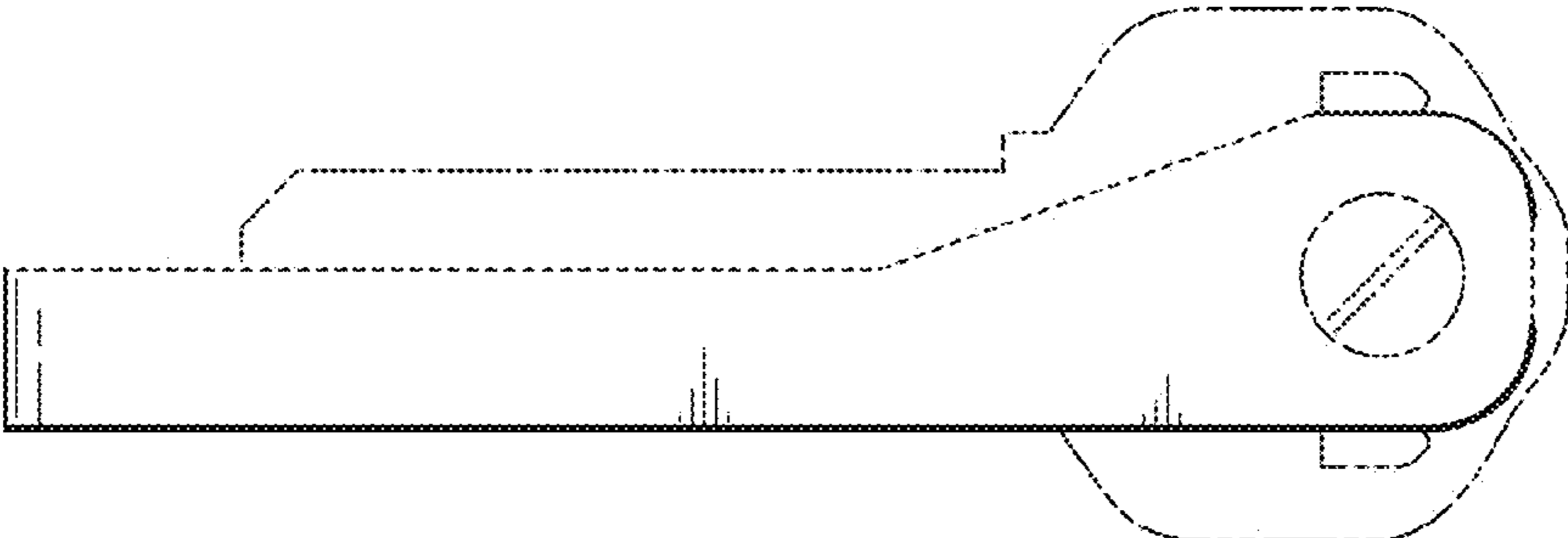

FIG. 22

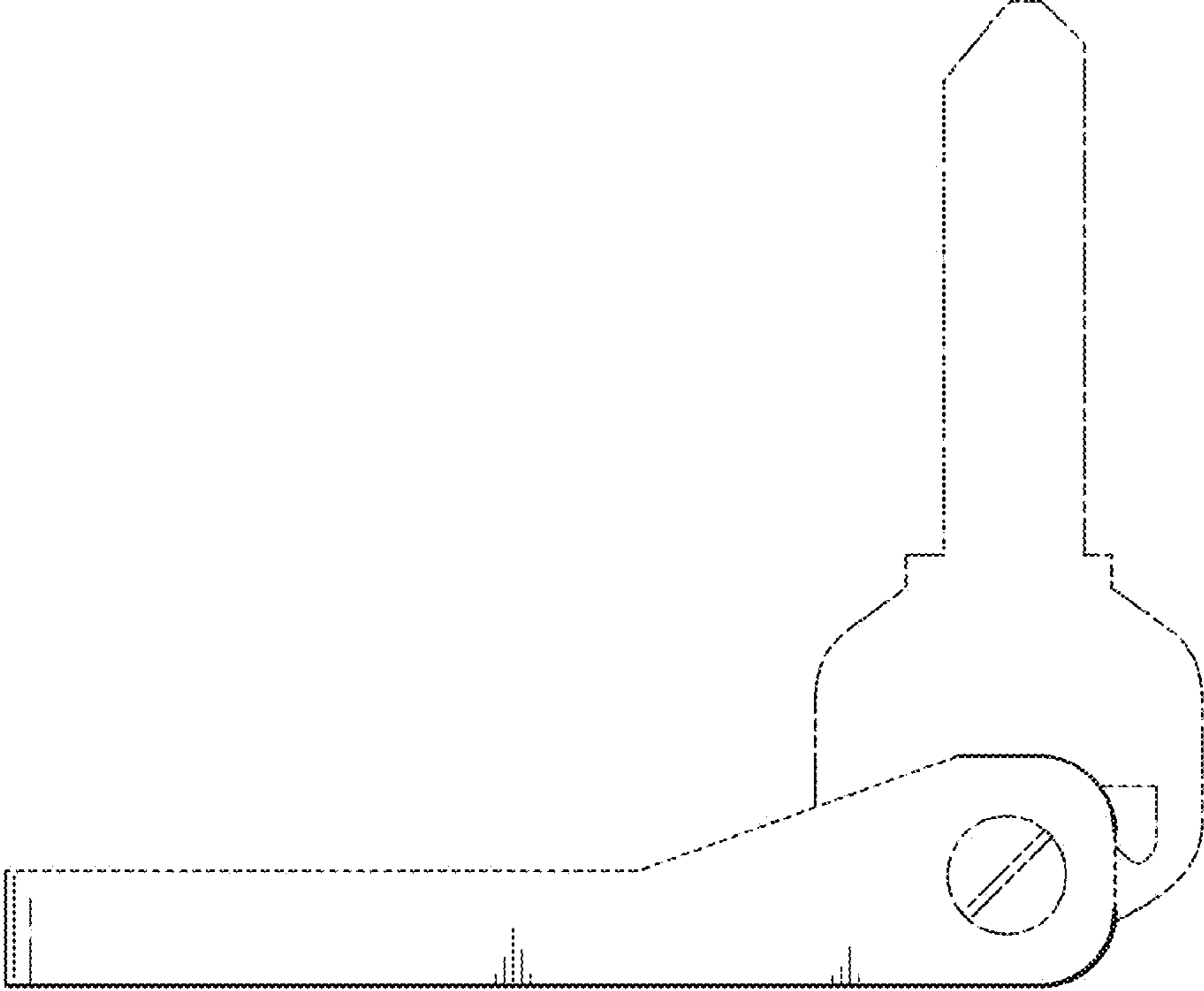

FIG. 23