

US00D759643S

(12) **United States Design Patent**
Amit et al.

(10) **Patent No.:** **US D759,643 S**
(45) **Date of Patent:** **** Jun. 21, 2016**

(54) **PORTION OF A HANDHELD DEVICE**

(71) Applicant: **Google Inc.**, Mountain View, CA (US)

(72) Inventors: **Gadi Amit**, San Mateo, CA (US); **Daniel J. Clifton**, San Francisco, CA (US); **Paul Eremenko**, Sunnyvale, CA (US); **Inbal Etgar**, San Francisco, CA (US); **Susan Elizabeth McKinney**, San Francisco, CA (US)

(73) Assignee: **Google Inc.**, Mountain View, CA (US)

(**) Term: **14 Years**

(21) Appl. No.: **29/495,461**

(22) Filed: **Jul. 1, 2014**

(51) **LOC (10) Cl.** **14-03**

(52) **U.S. Cl.**
USPC **D14/250**; D14/341; D14/345

(58) **Field of Classification Search**
USPC D14/341, 496, 138 AA, 138 R, 138 C,
D14/383, 250, 218, 440; 345/173;
455/575.1
CPC G06F 1/16
See application file for complete search history.

(56) **References Cited**

U.S. PATENT DOCUMENTS

- 3,075,529 A * 1/1963 Young, Jr. A61F 7/02
604/291
- D236,492 S * 8/1975 Helgesson D13/103
- D275,669 S * 9/1984 Genaro D14/149
- D289,873 S * 5/1987 Gemmell D14/374
- D299,718 S * 2/1989 Steer D14/150
- 4,825,618 A * 5/1989 Blevins E04F 13/142
52/535
- D323,503 S * 1/1992 Yoneyama D14/138 AA
- D338,076 S * 8/1993 Current D25/123

- D338,656 S * 8/1993 Spayde D14/341
- D346,580 S * 5/1994 Tattari D13/103
- D349,681 S * 8/1994 Siddoway D13/103
- D357,896 S * 5/1995 Berry D13/103
- D389,509 S * 1/1998 Yasoshima D18/17
- D391,298 S * 2/1998 Johnson D20/10
- 5,859,628 A * 1/1999 Ross B60R 16/0315
340/990
- D514,123 S * 1/2006 Naruki D14/203.3
- D535,631 S * 1/2007 Millora D14/126
- D557,673 S * 12/2007 Lee D14/138 AA
- D558,197 S * 12/2007 Forester D14/341
- D560,686 S * 1/2008 Kim D14/496
- D561,783 S * 2/2008 Schmelling D14/496

(Continued)

Primary Examiner — Paula Greene

(74) *Attorney, Agent, or Firm* — Fish & Richardson P.C.

(57) **CLAIM**

The ornamental design for a portion of a handheld device, substantially as shown and described.

DESCRIPTION

FIG. 1 is a perspective side view of a first embodiment of a handheld device.

FIG. 2 is a front view of the embodiment of FIG. 1.

FIG. 3 is a rear view of the embodiment of FIG. 1.

FIG. 4 is a left side view of the embodiment of FIG. 1.

FIG. 5 is a right side view of the embodiment of FIG. 1.

FIG. 6 is a bottom view of the embodiment of FIG. 1; and, FIG. 7 is a top view of the embodiment of FIG. 1.

The claimed design, bordered by a dot-dash line in the perspective and rear views, is illustrated in these two examples as a portion of a side edge of a handheld electronic device, such as a mobile telephone or tablet. The design features modules bounded by and protruding from a frame having orthogonal ribs.

The broken lines in each figure illustrate graphical environmental features that form no part of the claimed design.

1 Claim, 4 Drawing Sheets

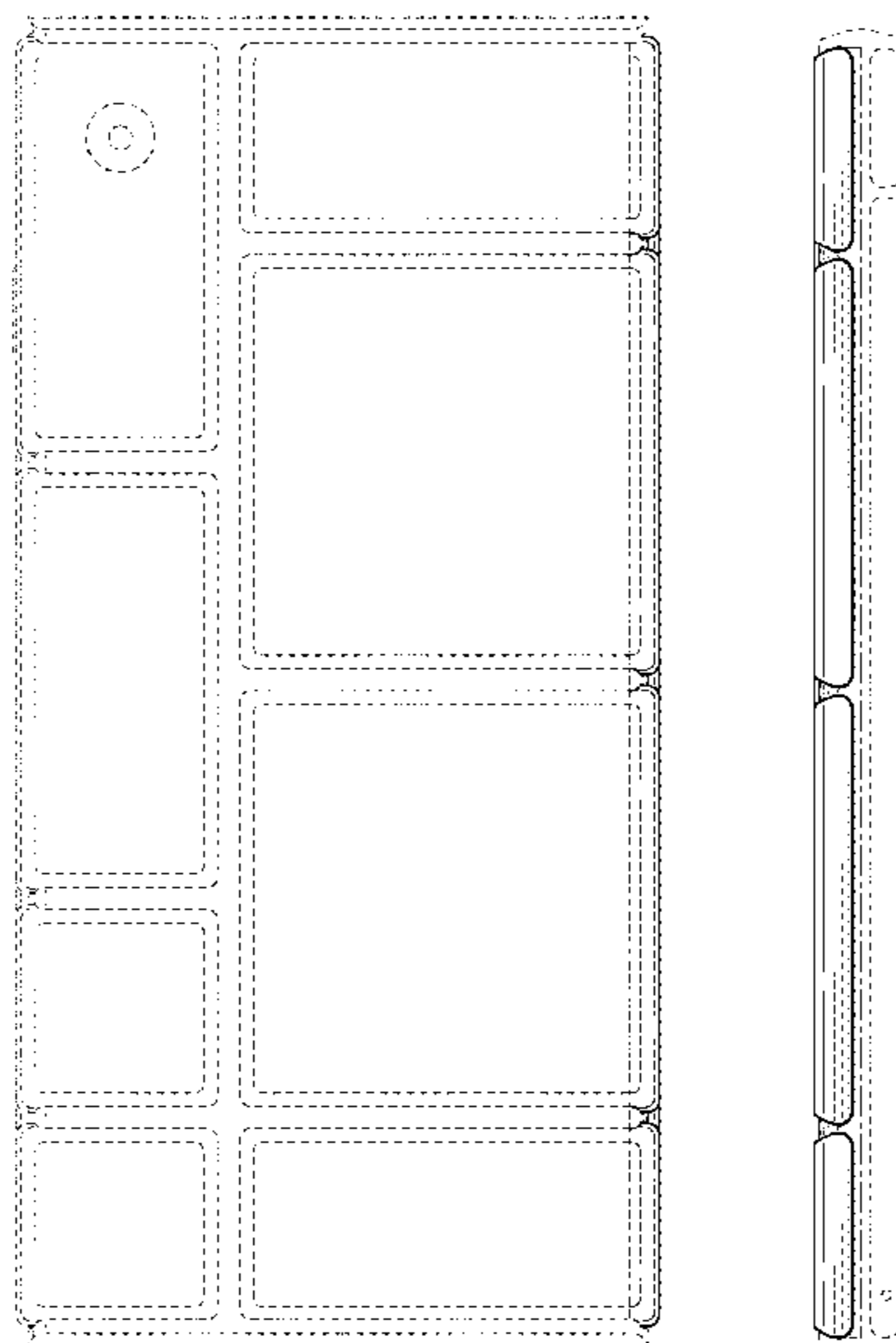

(56)

References Cited

U.S. PATENT DOCUMENTS

D567,819 S * 4/2008 Devericks D14/496
 D573,565 S * 7/2008 Edwards D14/138 AA
 7,433,719 B2 * 10/2008 Dabov H01H 13/84
 345/168
 D580,387 S * 11/2008 Andre D14/138 G
 D583,479 S * 12/2008 Yim D24/206
 D592,646 S * 5/2009 Sun D14/218
 D594,030 S * 6/2009 Rayn D14/496
 D596,305 S * 7/2009 Usui D24/206
 D602,014 S * 10/2009 Andre D14/341
 D604,727 S * 11/2009 Chu D14/248
 D606,061 S * 12/2009 Chen D14/248
 D606,986 S * 12/2009 de Jong D14/250
 D607,427 S * 1/2010 Ho D14/138 AA
 D620,919 S * 8/2010 Lee D14/203.3
 D627,344 S * 11/2010 Chien D14/138 G
 D629,799 S * 12/2010 Andre D14/341
 D634,313 S * 3/2011 Fitzpatrick D14/250
 D634,394 S * 3/2011 Whitman D23/201

7,899,504 B2 * 3/2011 Impio H04M 1/0247
 455/550.1
 D635,536 S * 4/2011 Xiao D14/138 AA
 D638,015 S * 5/2011 Chong D14/336
 D641,333 S * 7/2011 Lee D14/138 AA
 D641,346 S * 7/2011 Fathollahi D14/250
 D654,931 S * 2/2012 Lemelman D14/496
 D655,699 S * 3/2012 Bau D14/250
 D656,494 S * 3/2012 Bau D14/250
 D662,932 S * 7/2012 Park D14/341
 8,245,843 B1 * 8/2012 Wu H01M 10/465
 150/165
 D671,948 S * 12/2012 Akana D14/440
 D674,801 S * 1/2013 Wharram D13/102
 D685,776 S * 7/2013 Bau D14/250
 D698,341 S * 1/2014 Lee D14/248
 D701,205 S * 3/2014 Akana D14/341
 D714,784 S * 10/2014 Park D14/341
 D719,145 S * 12/2014 Barfoot D14/250
 D723,041 S * 2/2015 Kim D14/440
 D726,169 S * 4/2015 Powell D14/250
 2010/0089779 A1 * 4/2010 Bowers A45C 7/0095
 206/320

* cited by examiner

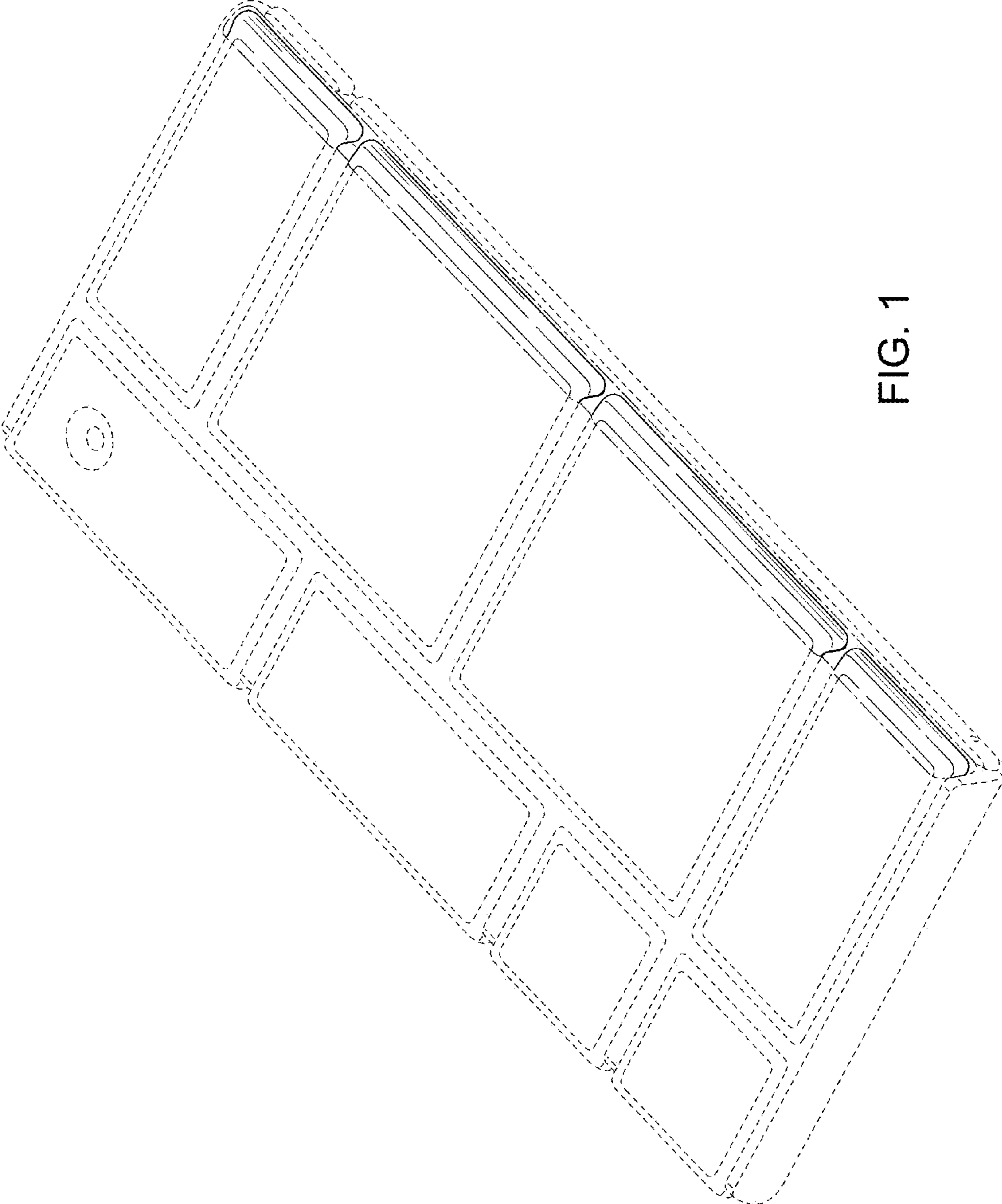

FIG. 1

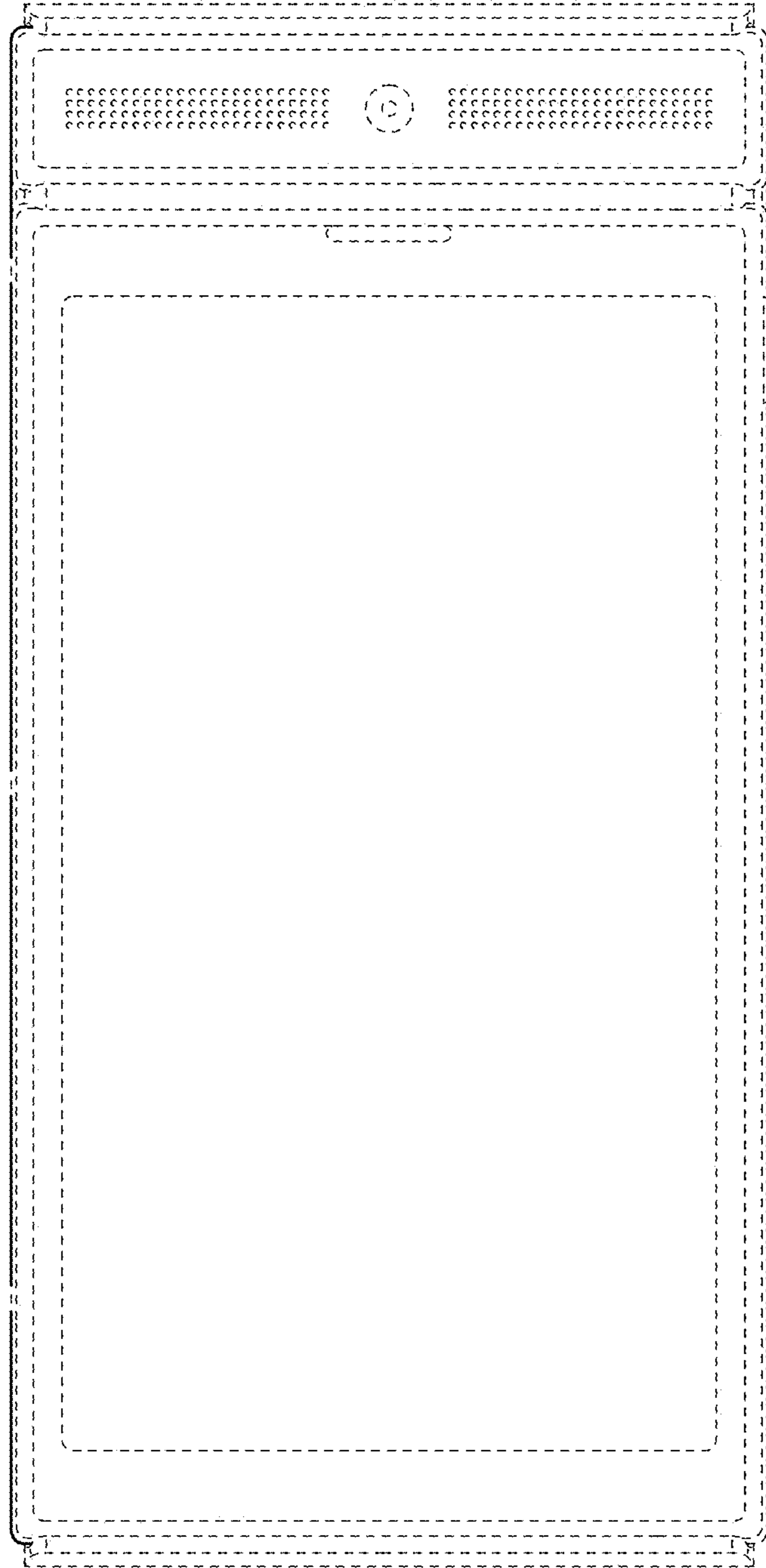

FIG. 2

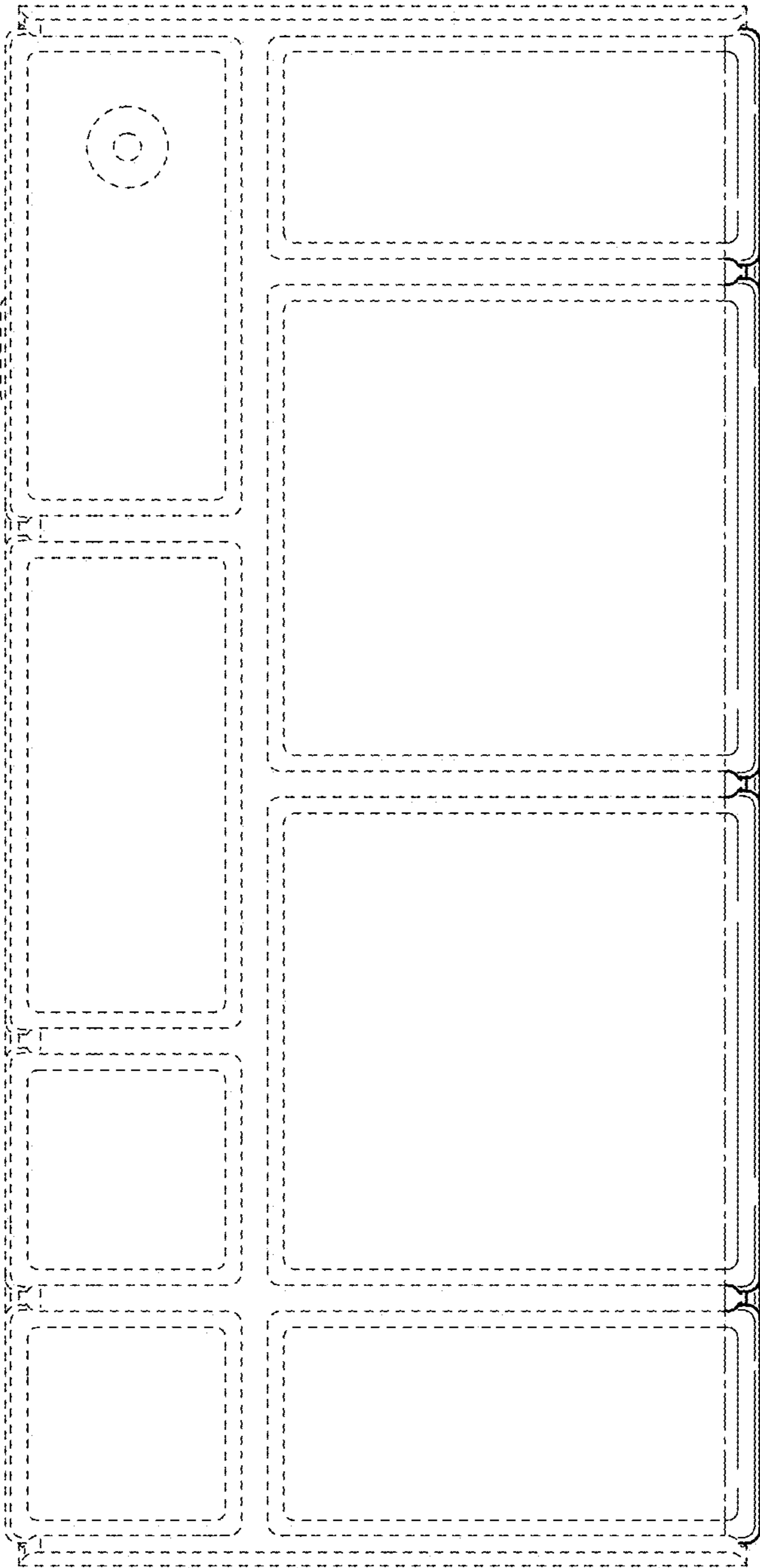

FIG. 3

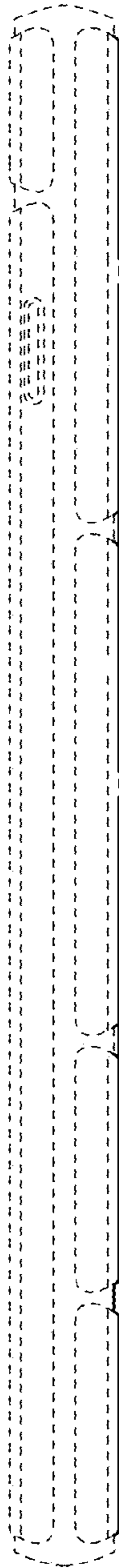

FIG. 4

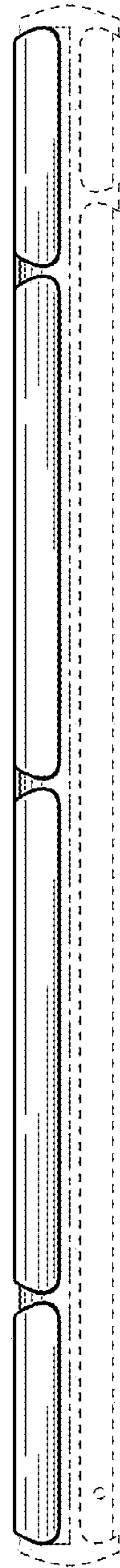

FIG. 5

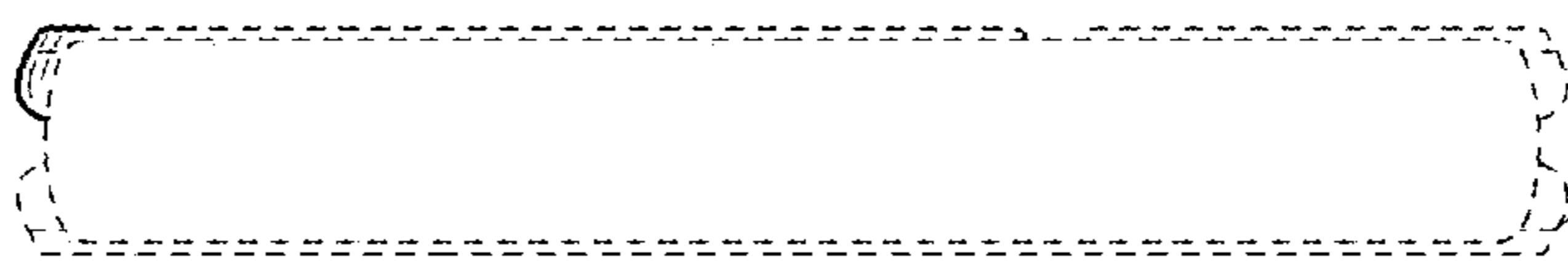

FIG. 6

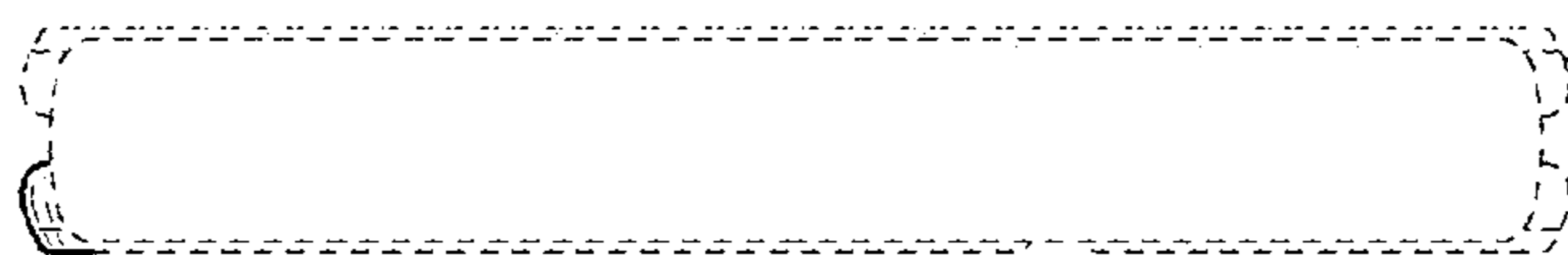

FIG. 7