



US00D759613S

(12) **United States Design Patent**
Han et al.

(10) **Patent No.:** **US D759,613 S**
(45) **Date of Patent:** **** Jun. 21, 2016**

(54) **TV RECEIVER**

(71) Applicant: **LG ELECTRONICS INC.**, Seoul (KR)

(72) Inventors: **Youngsoo Han**, Seoul (KR); **Jongho Kim**, Seoul (KR); **Sunha Park**, Seoul (KR); **Youngkyoung Kim**, Seoul (KR); **Nari Lee**, Seoul (KR)

(73) Assignee: **LG ELECTRONICS INC.**, Seoul (KR)
(**) Term: **15 Years**

(21) Appl. No.: **29/529,231**

(22) Filed: **Jun. 4, 2015**

(30) **Foreign Application Priority Data**

Dec. 5, 2014 (KR) 30-2014-0059294

(51) **LOC (10) Cl.** **14-03**

(52) **U.S. Cl.**
USPC **D14/126**

(58) **Field of Classification Search**

USPC D14/125-134, 239, 371, 136, 374-377,
D14/440, 450, 448, 336, 342, 159; 312/7.2;
348/836, 838, 180, 184, 325, 739;
248/917-924, 465; 345/104, 133, 156,
345/168, 87, 173; D21/329, 515, 577, 622,
D21/333, 433, 448, 452, 450, 331, 505;
D10/15, 26; 446/484, 175, 356;
D6/477, 479, 300; D20/10, 19, 39
CPC ... G06F 1/1601; G06F 1/1643; H05K 5/0004;
H05K 5/0017; H05K 5/02; H05K 5/0217;
H04N 13/0459

See application file for complete search history.

(56) **References Cited**

U.S. PATENT DOCUMENTS

D531,968 S * 11/2006 Nakata D14/126
D536,311 S * 2/2007 Park D14/126

(Continued)

Primary Examiner — Raphael Barkai

(74) *Attorney, Agent, or Firm* — Birch, Stewart, Kolasch & Birch, LLP

(57) **CLAIM**

The ornamental design for a TV receiver, as shown and described.

DESCRIPTION

FIG. 1 is a front, right side, perspective view of a TV receiver showing our new design;

FIG. 2 is a front view thereof;

FIG. 3 is a rear view thereof;

FIG. 4 is a left side view thereof;

FIG. 5 is a right side view thereof;

FIG. 6 is a top view thereof;

FIG. 7 is a bottom view thereof;

FIG. 8 is a rear, right side, perspective view thereof;

FIG. 9 is a front, right side, perspective view with its front display sliding up slightly thereof;

FIG. 10 is a front view with its front display sliding up slightly thereof;

FIG. 11 is a rear view with its front display sliding up slightly thereof;

FIG. 12 is a left side view with its front display sliding up slightly thereof;

FIG. 13 is a right side view with its front display sliding up slightly thereof;

FIG. 14 is a top view with its front display sliding up slightly thereof;

FIG. 15 is a bottom view with its front display sliding up slightly thereof;

FIG. 16 is a front, right side, perspective view with its front display sliding up fully thereof;

FIG. 17 is a front view with its front display sliding up fully thereof;

FIG. 18 is a rear view with its front display sliding up fully thereof;

FIG. 19 is a left side view with its front display sliding up fully thereof;

FIG. 20 is a right side view with its front display sliding up fully thereof;

FIG. 21 is a top view with its front display sliding up fully thereof;

FIG. 22 is a bottom view with its front display sliding up fully thereof;

FIG. 23 is a front, right side, perspective view with its front display sliding up fully and bending thereof;

FIG. 24 is a front view with its front display sliding up fully and bending thereof;

FIG. 25 is a rear view with its front display sliding up fully and bending thereof;

FIG. 26 is a left side view with its front display sliding up fully and bending thereof;

FIG. 27 is a right side view with its front display sliding up fully and bending thereof;

FIG. 28 is a top view with its front display sliding up fully and bending thereof; and,

FIG. 29 is a bottom view with its front display sliding up fully and bending thereof.

The broken lines indicate unclaimed portion of the article that form no part of the claimed design.

1 Claim, 22 Drawing Sheets

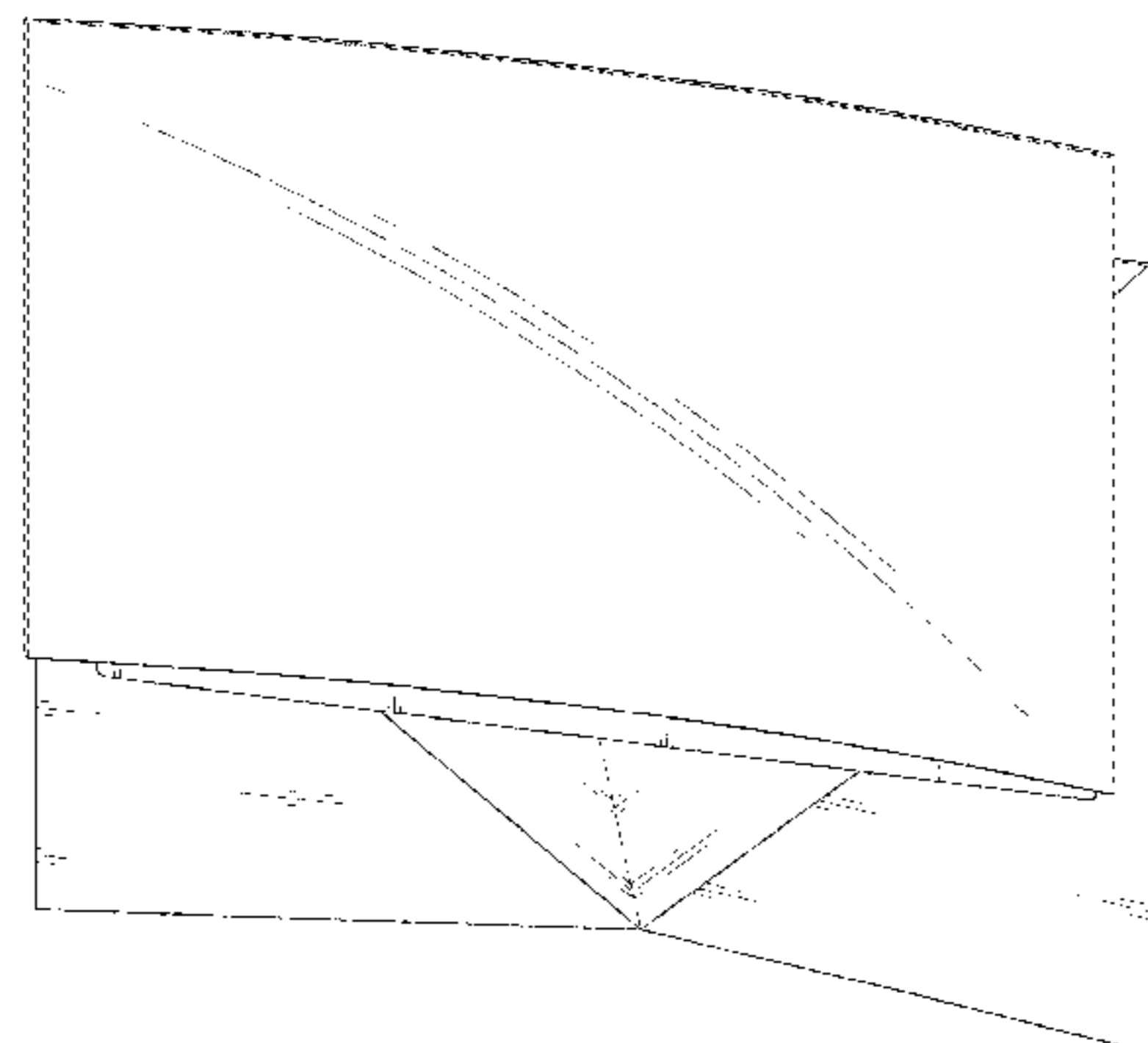
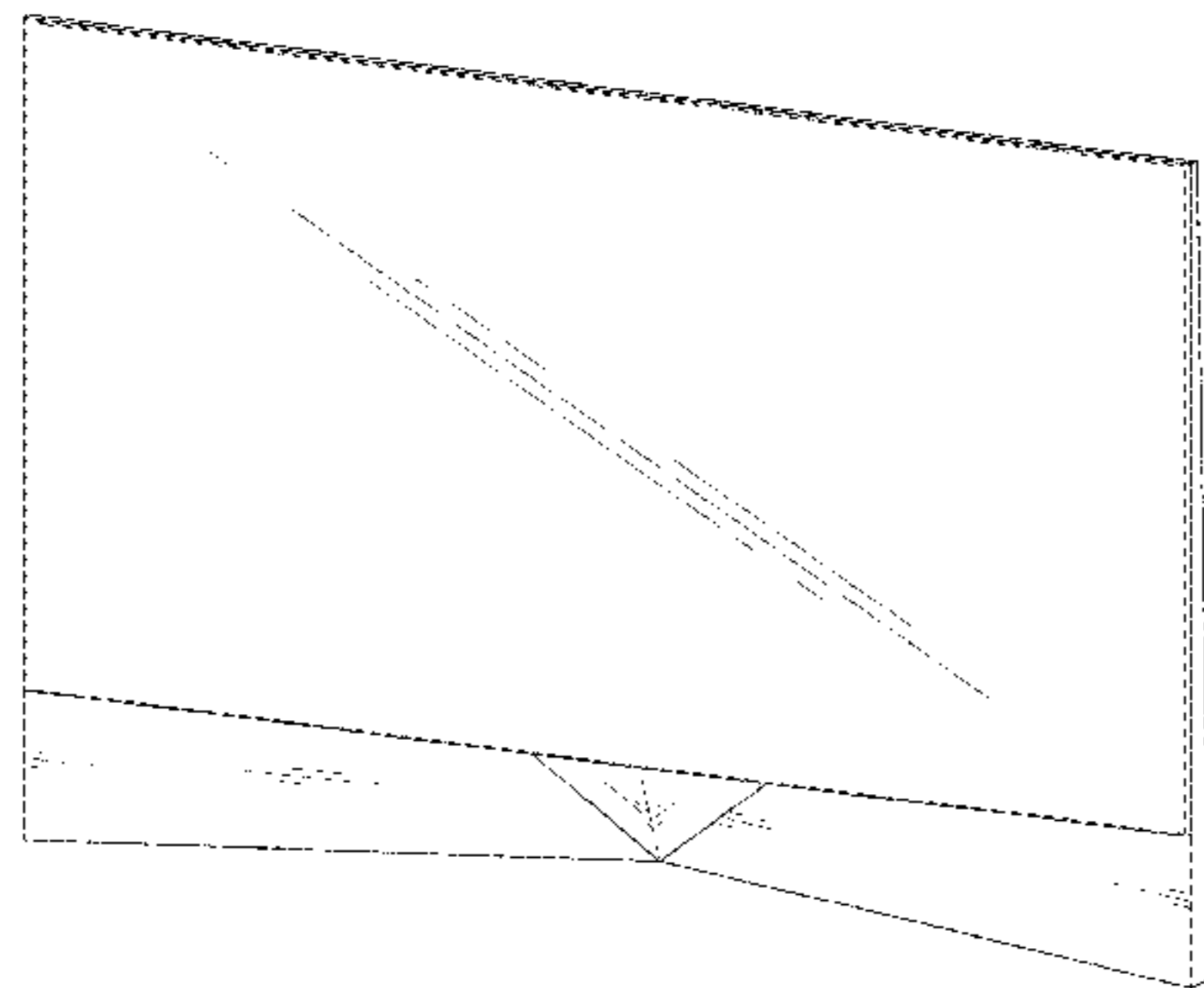

(56)

References Cited

U.S. PATENT DOCUMENTS

D536,677 S *	2/2007	Kim	D14/126	D718,263 S *	11/2014	Kim	D14/126
D572,214 S *	7/2008	Lewis	D14/126	D719,120 S *	12/2014	Park	D14/126
D582,364 S *	12/2008	Lewis	D14/126	D730,857 S *	6/2015	Park	D14/126
D597,041 S *	7/2009	Cho	D14/126	D736,168 S *	8/2015	Kim	D14/126
D628,176 S *	11/2010	Chien	D14/126	D736,169 S *	8/2015	Kim	D14/126
D661,123 S *	6/2012	Curbbun	D20/10	D737,235 S *	8/2015	Kim	D14/126
D697,882 S *	1/2014	Seong	D14/126	D738,838 S *	9/2015	Seo	D14/126
D709,468 S *	7/2014	Seo	D14/126	D740,242 S *	10/2015	Park	D14/126
D712,367 S *	9/2014	Park	D14/126	D742,344 S *	11/2015	Kim	D14/126
					D744,446 S *	12/2015	Kim	D14/126
					D746,243 S *	12/2015	Gao	D14/126

* cited by examiner

FIG. 1

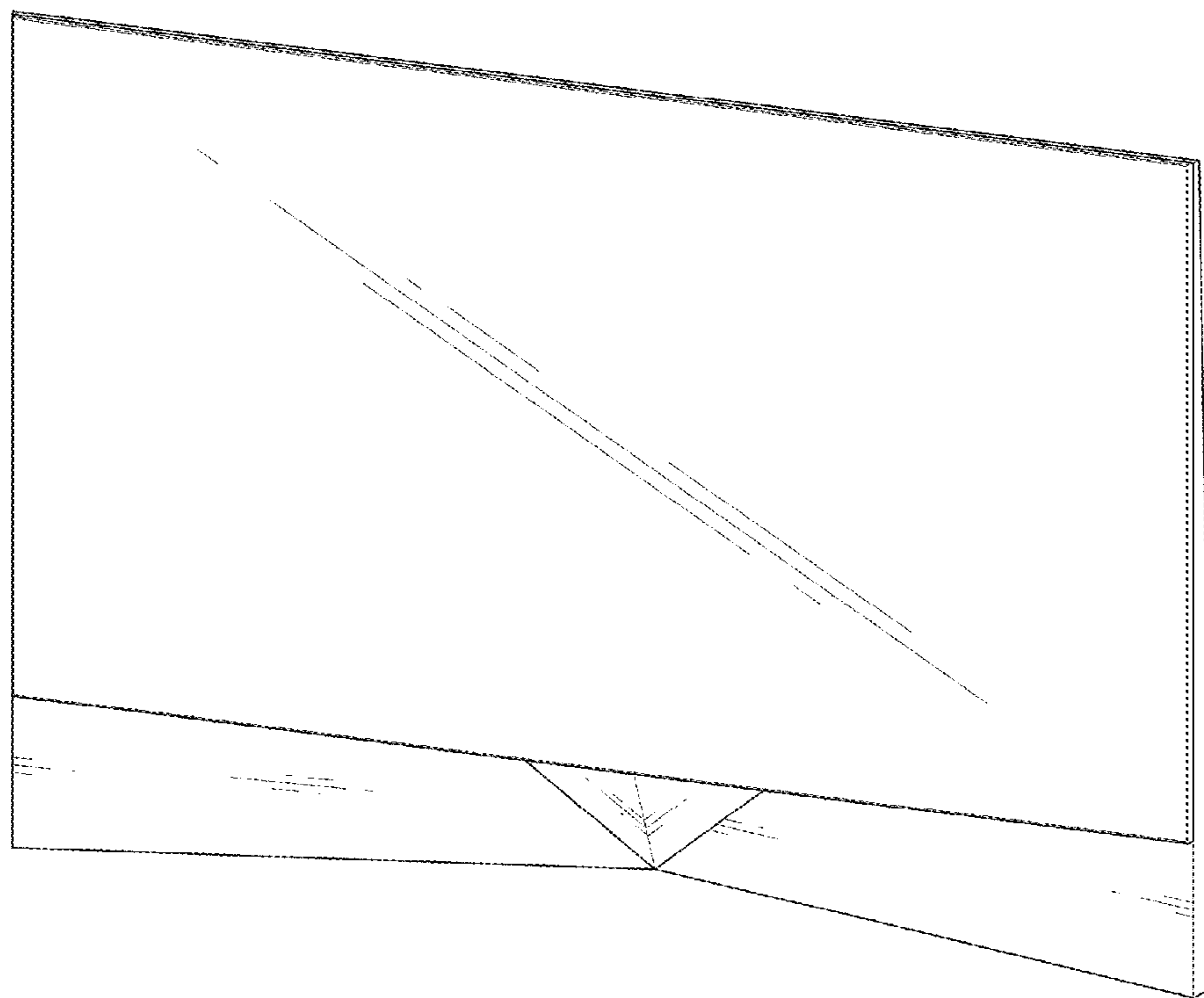

FIG. 2

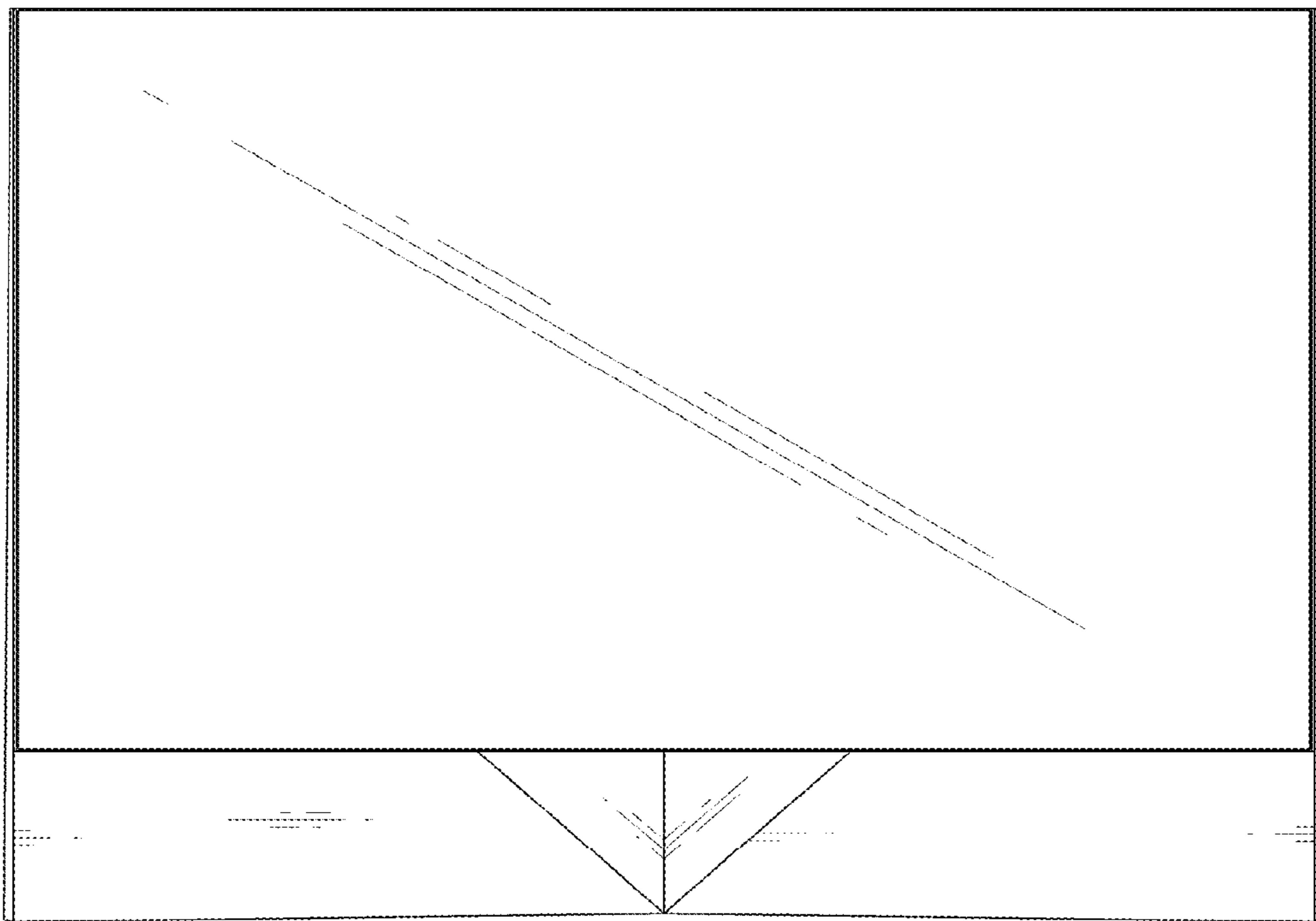

FIG. 3

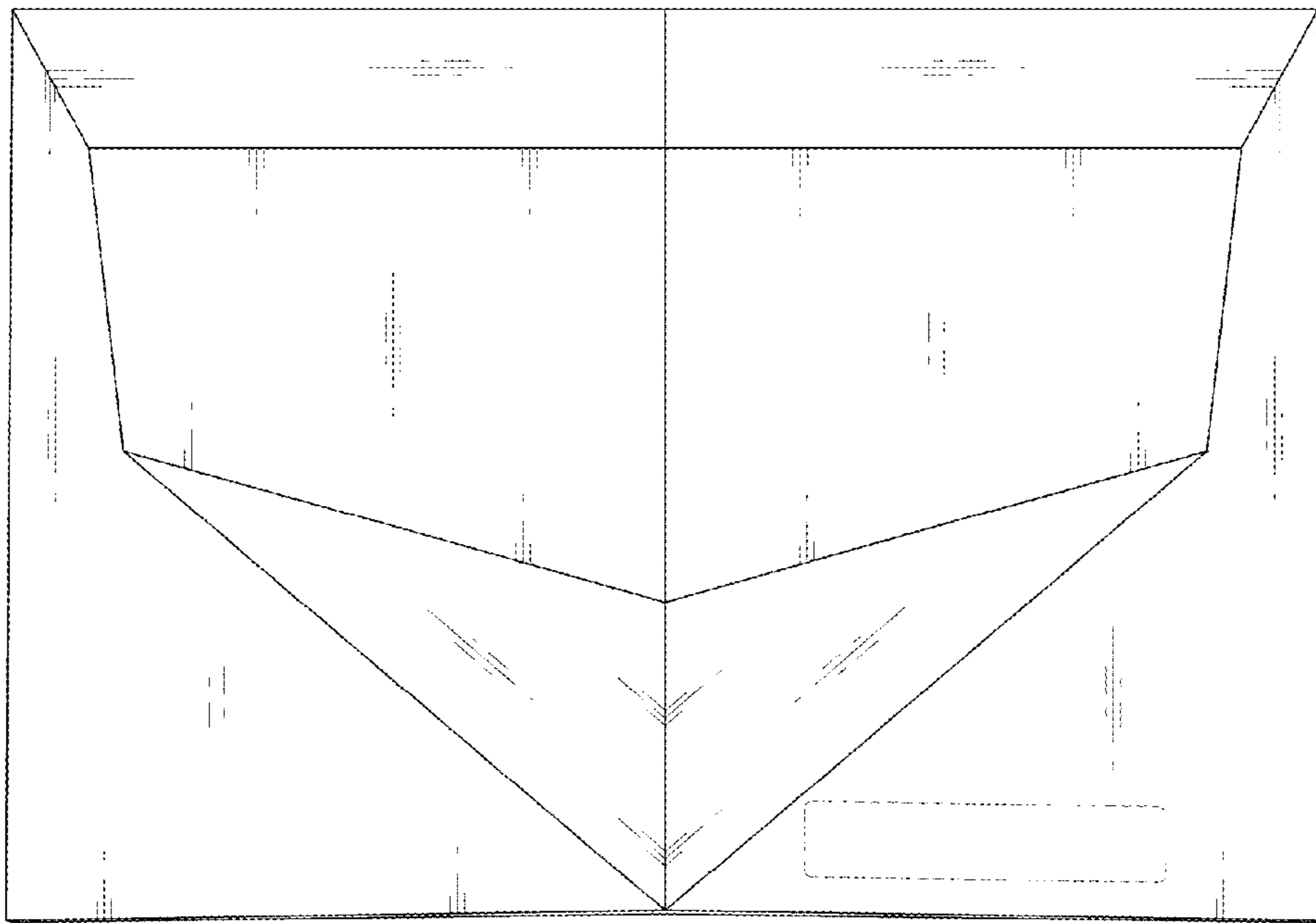

FIG. 4

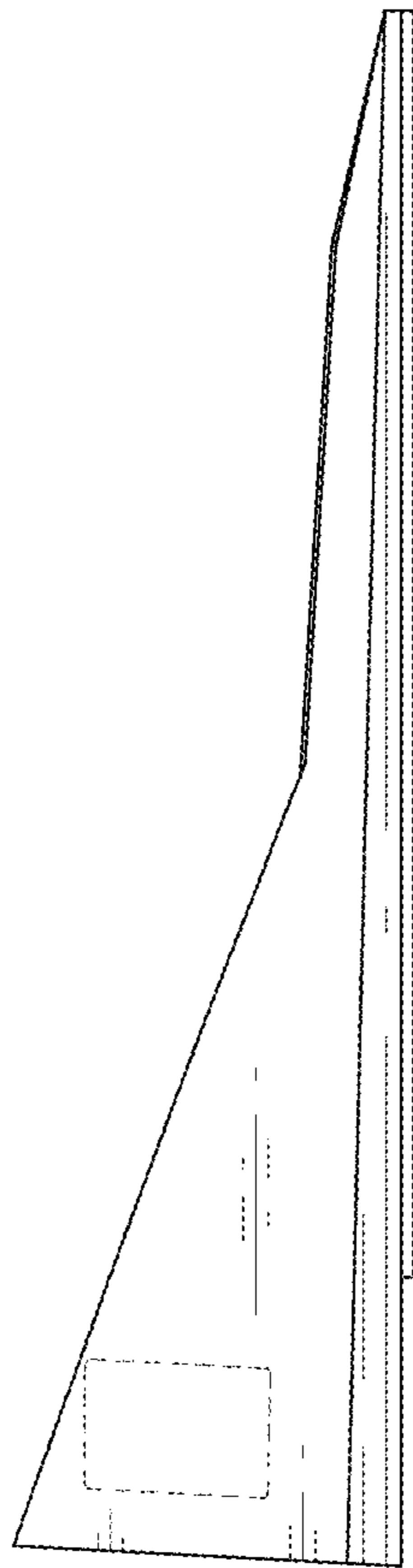

FIG. 5

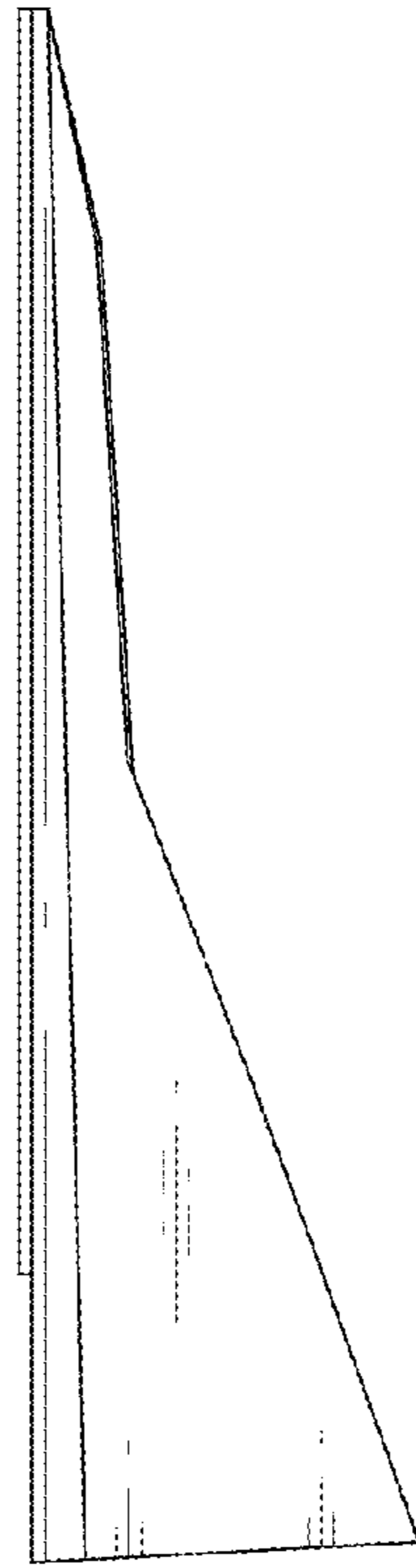

FIG. 6

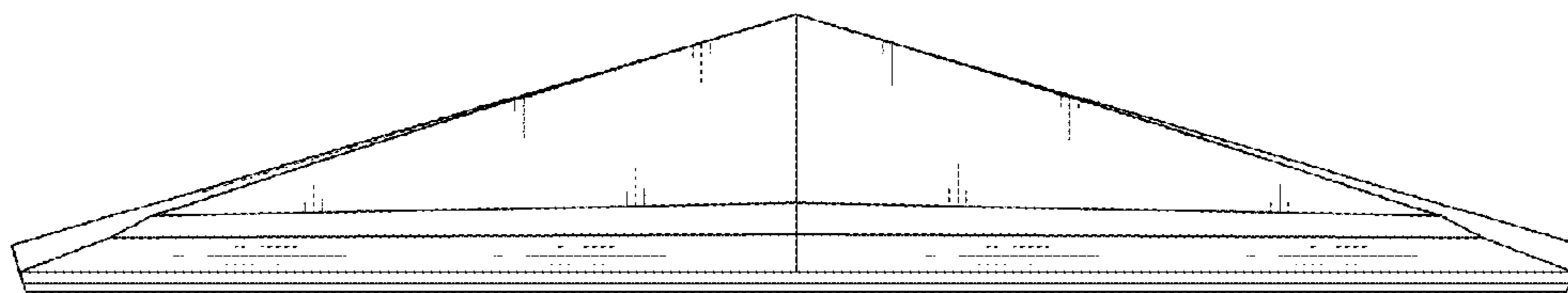

FIG. 7

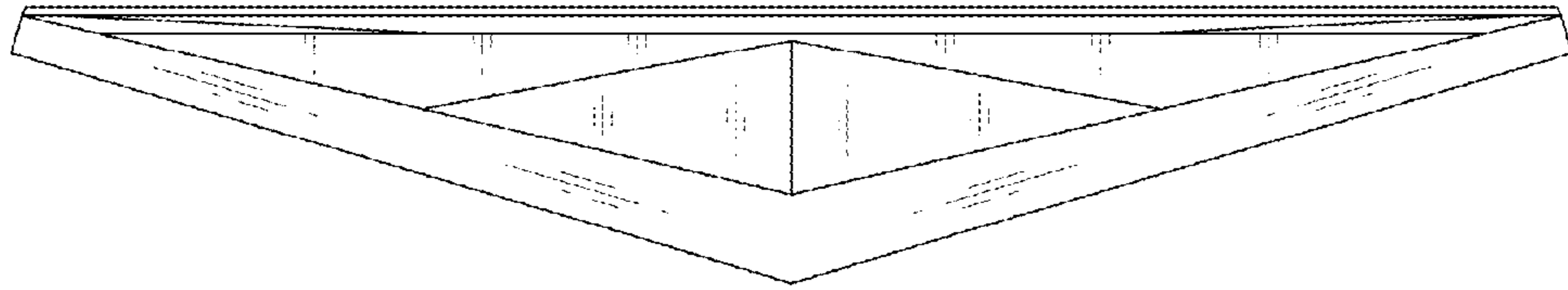

FIG. 8

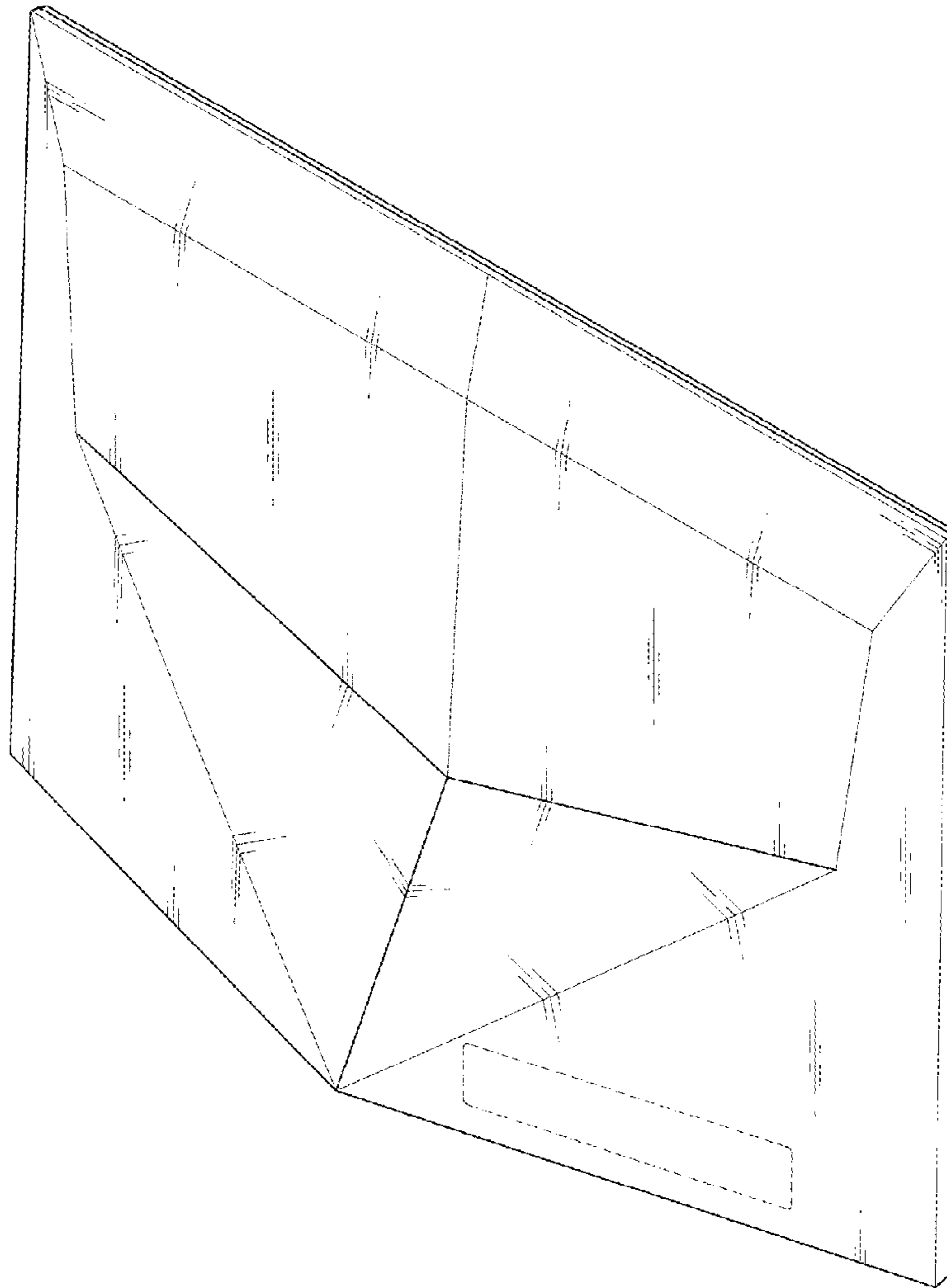

FIG. 9

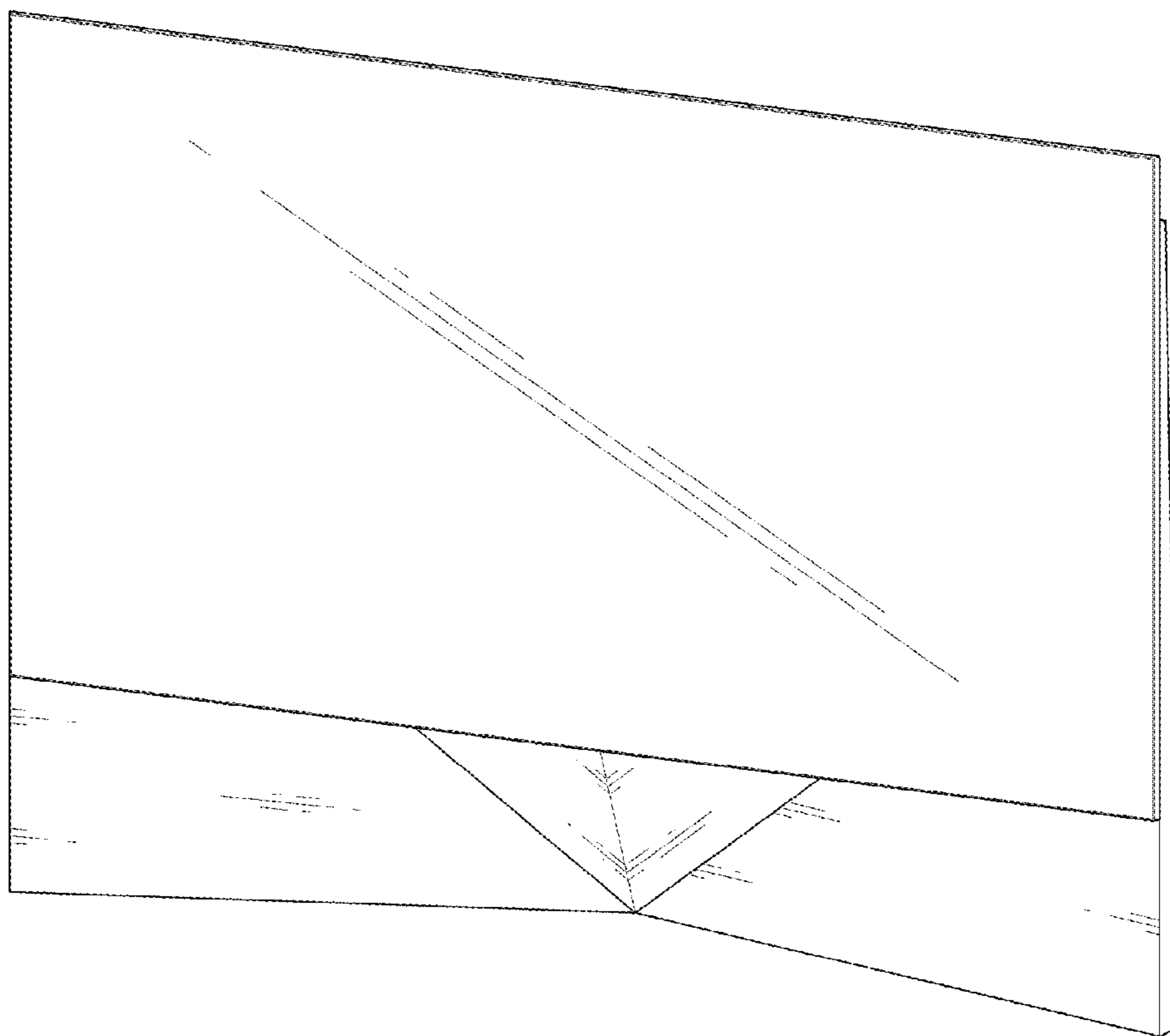

FIG. 10

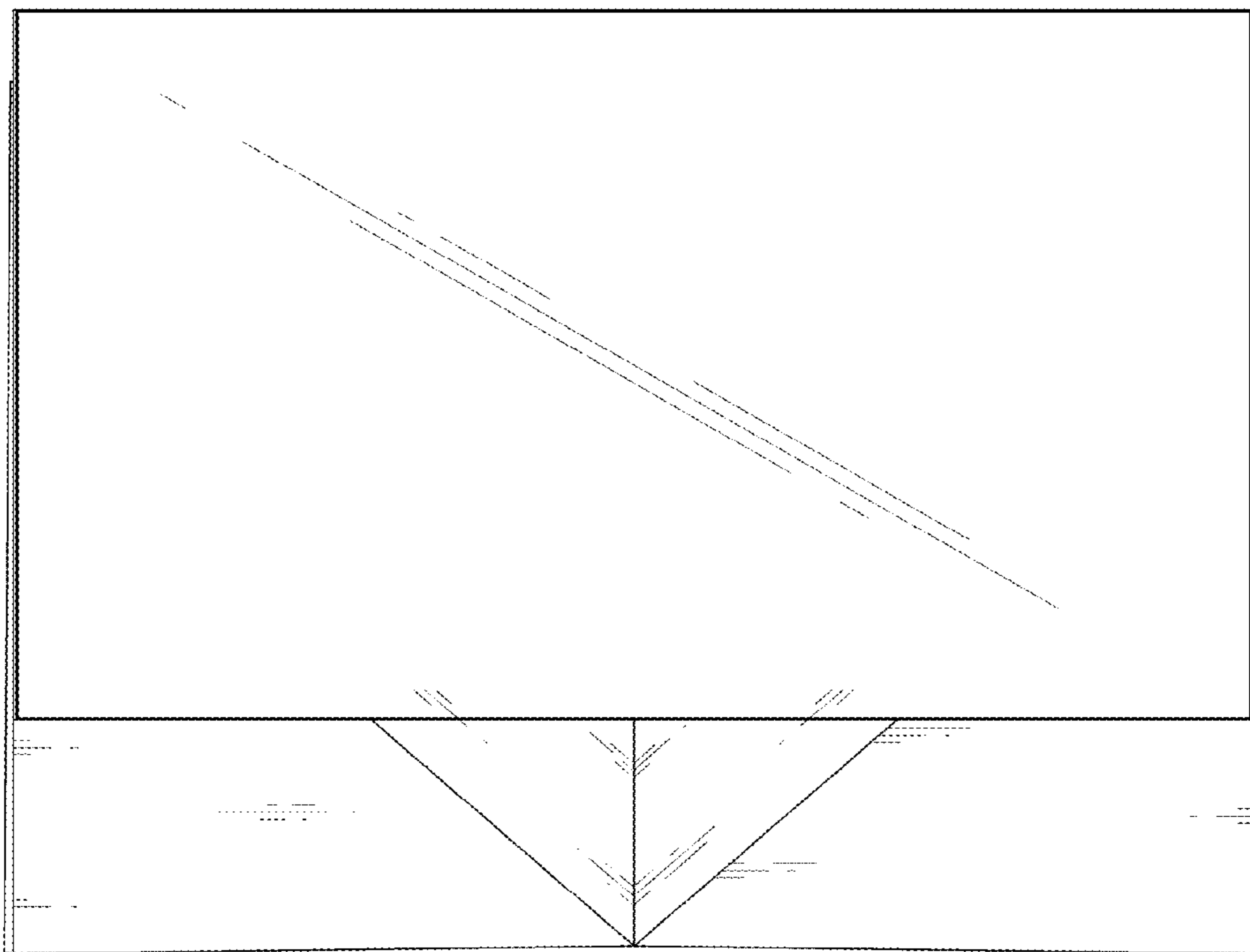

FIG. 11

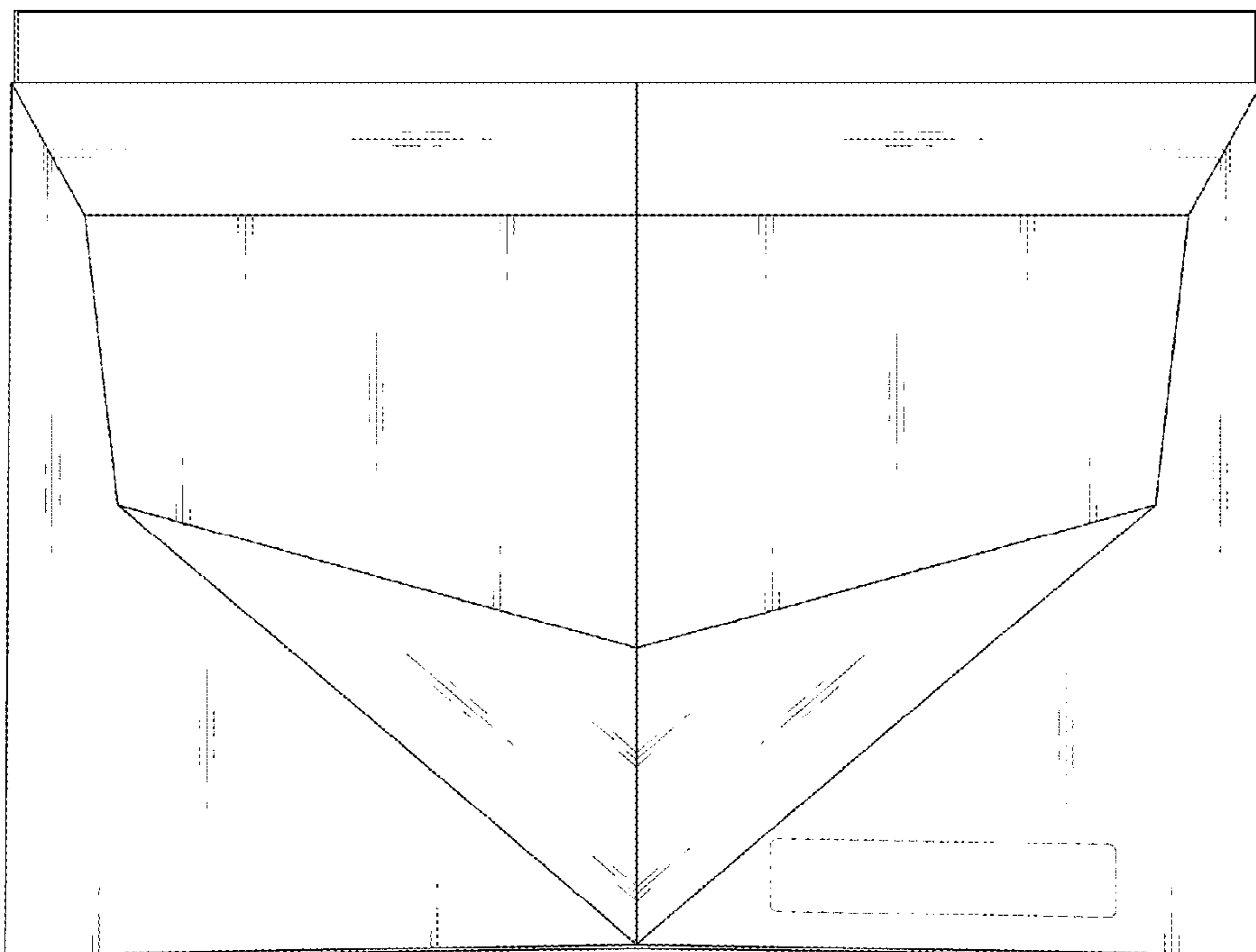

FIG. 12

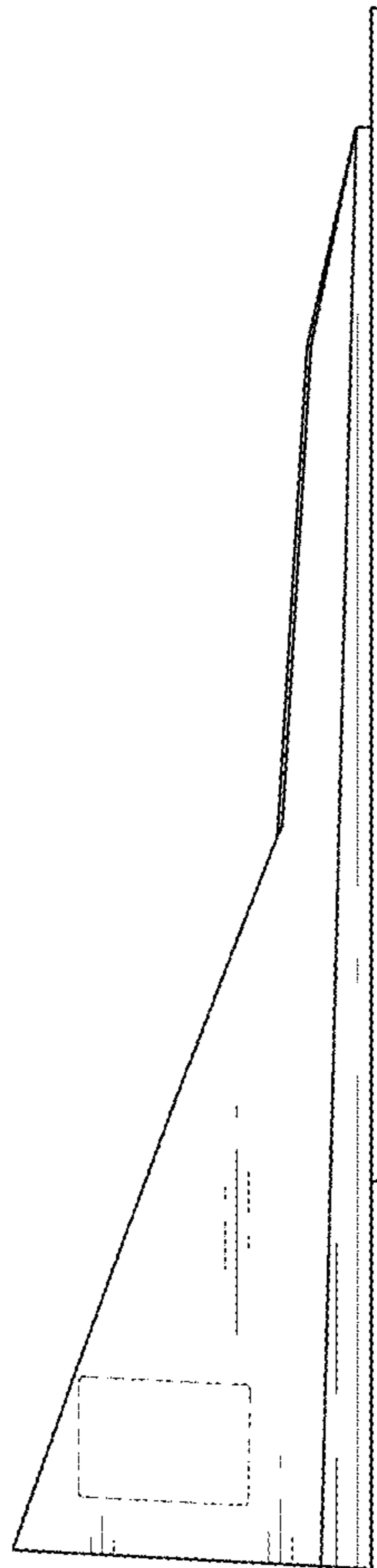

FIG. 13

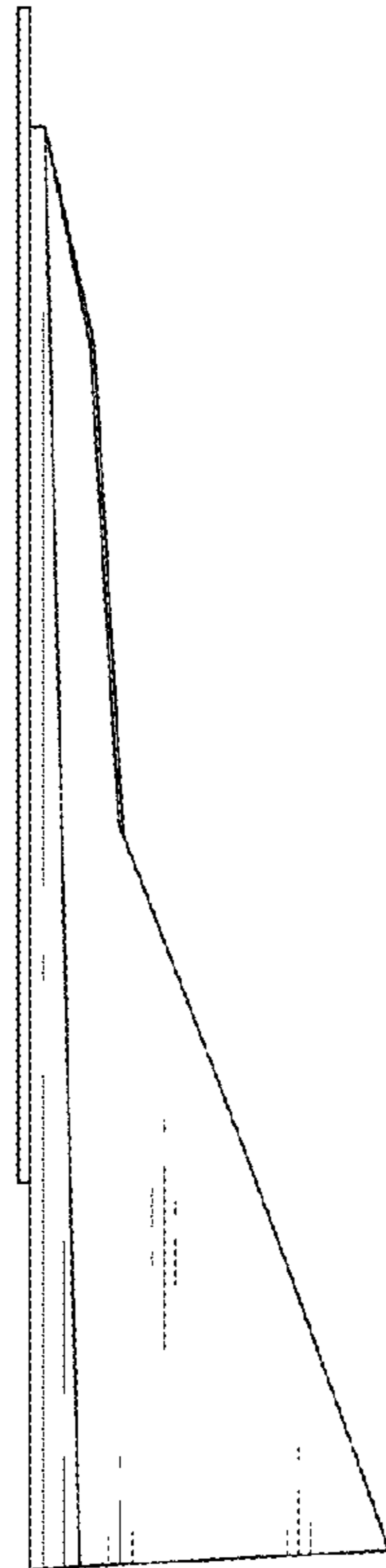

FIG. 14

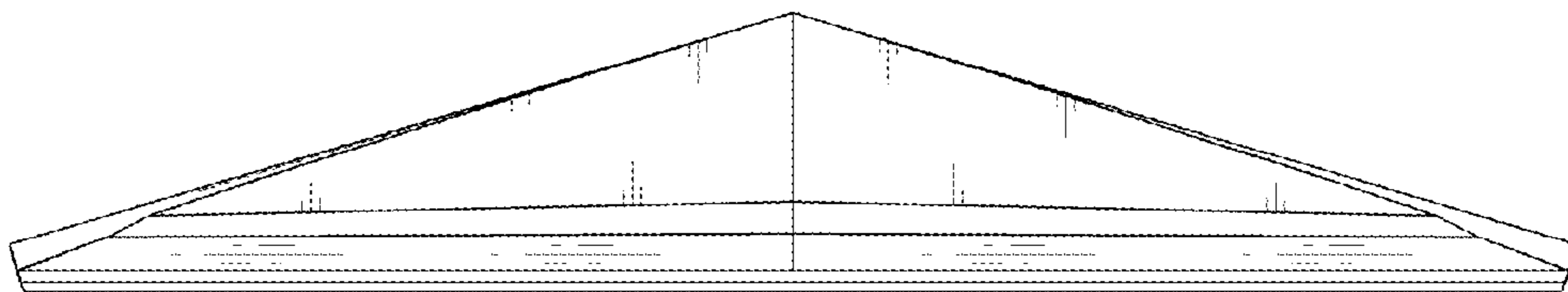

FIG. 15

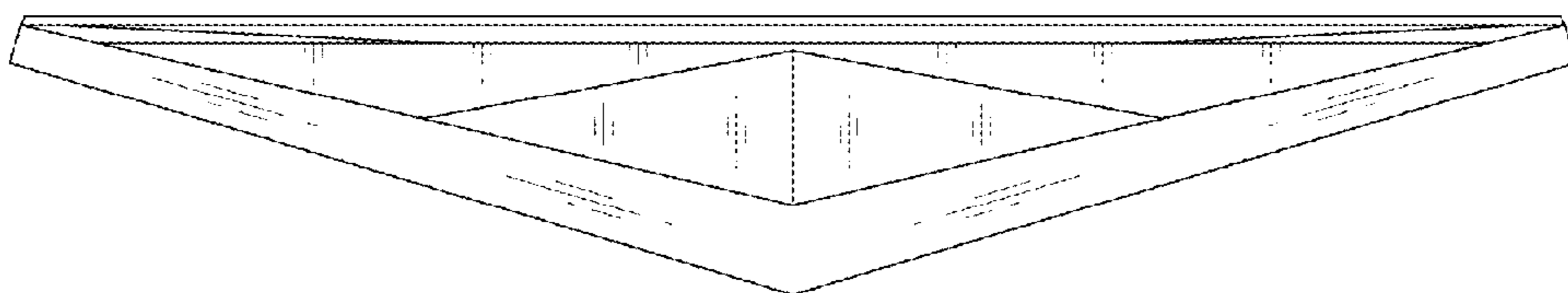

FIG. 16

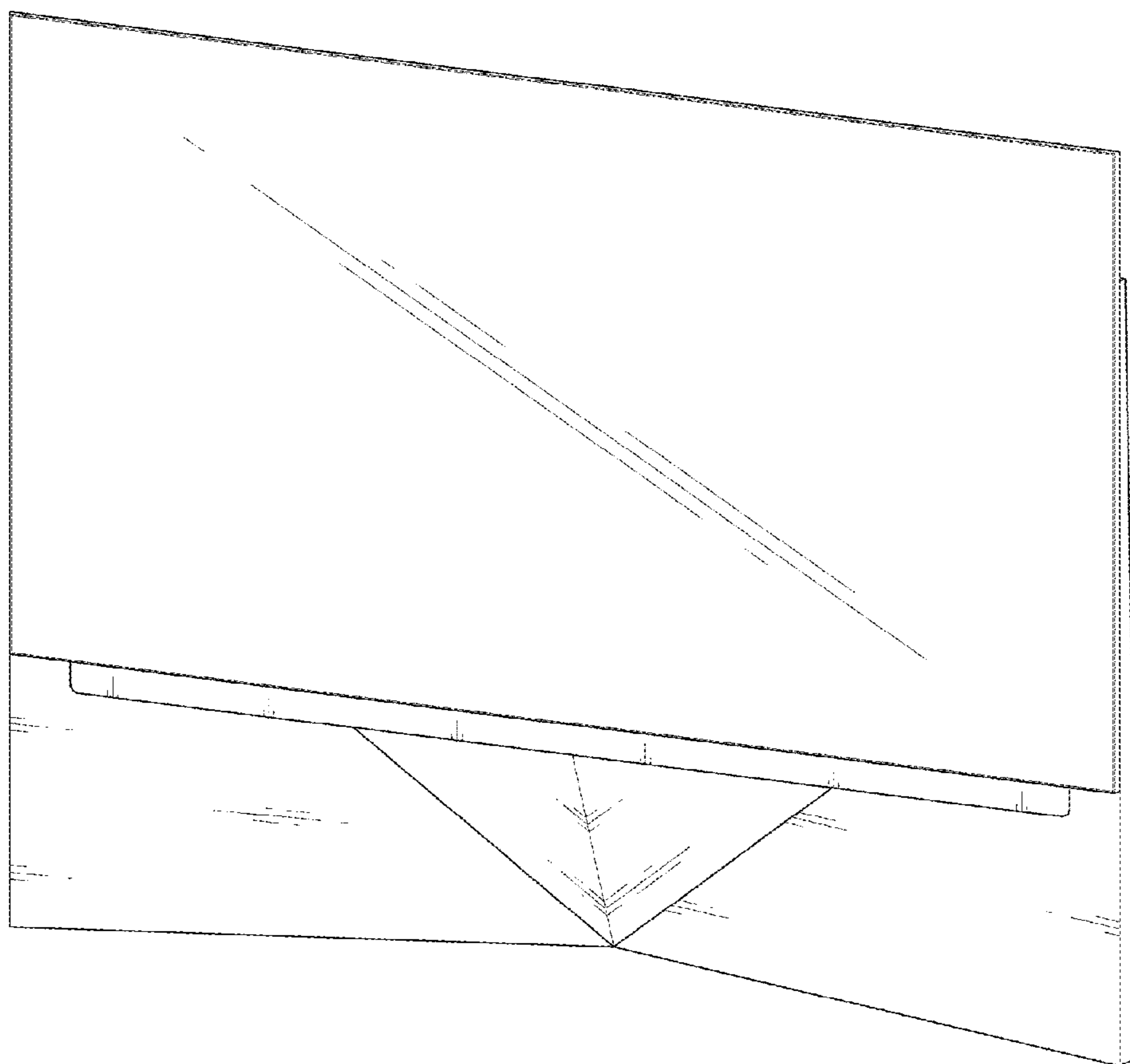

FIG. 17

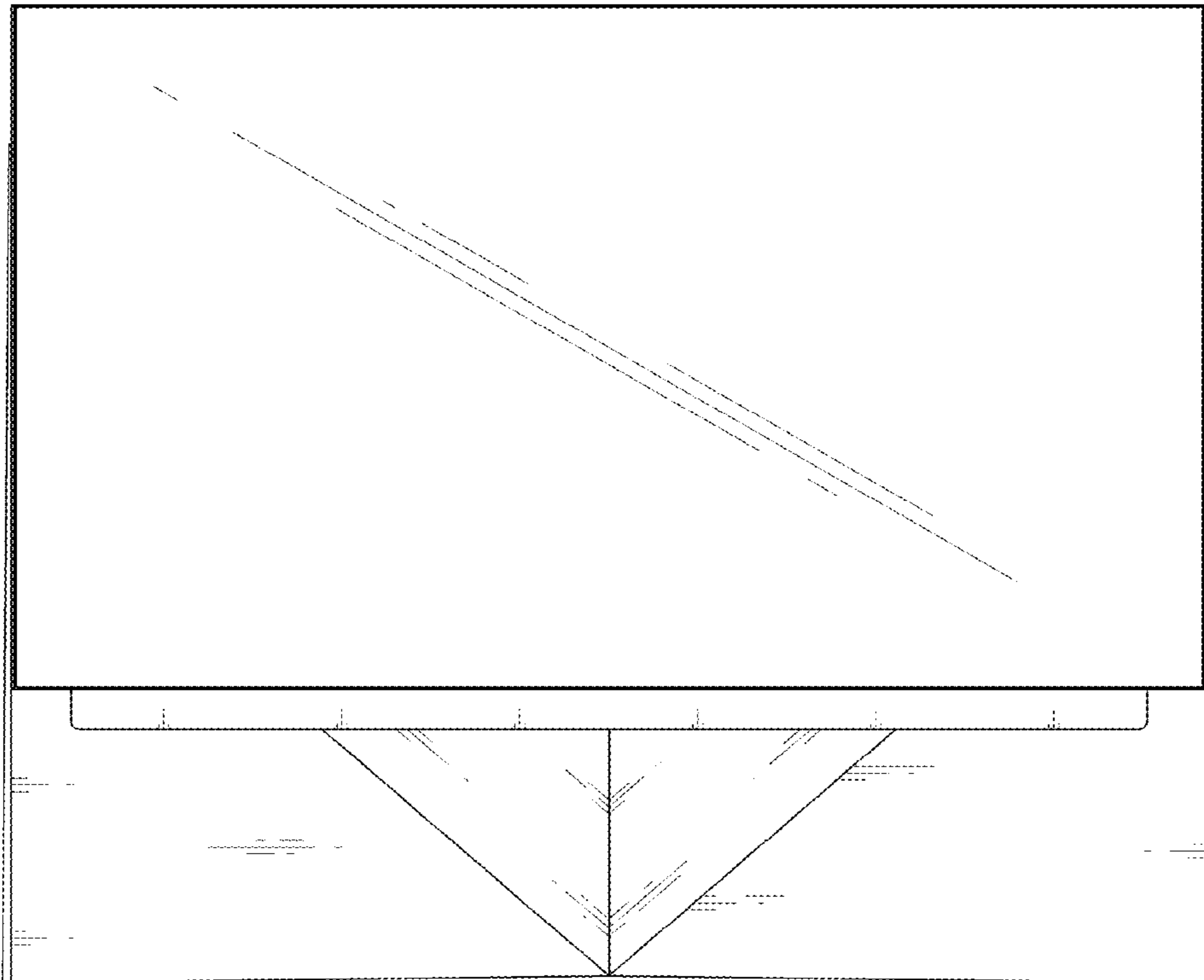

FIG. 18

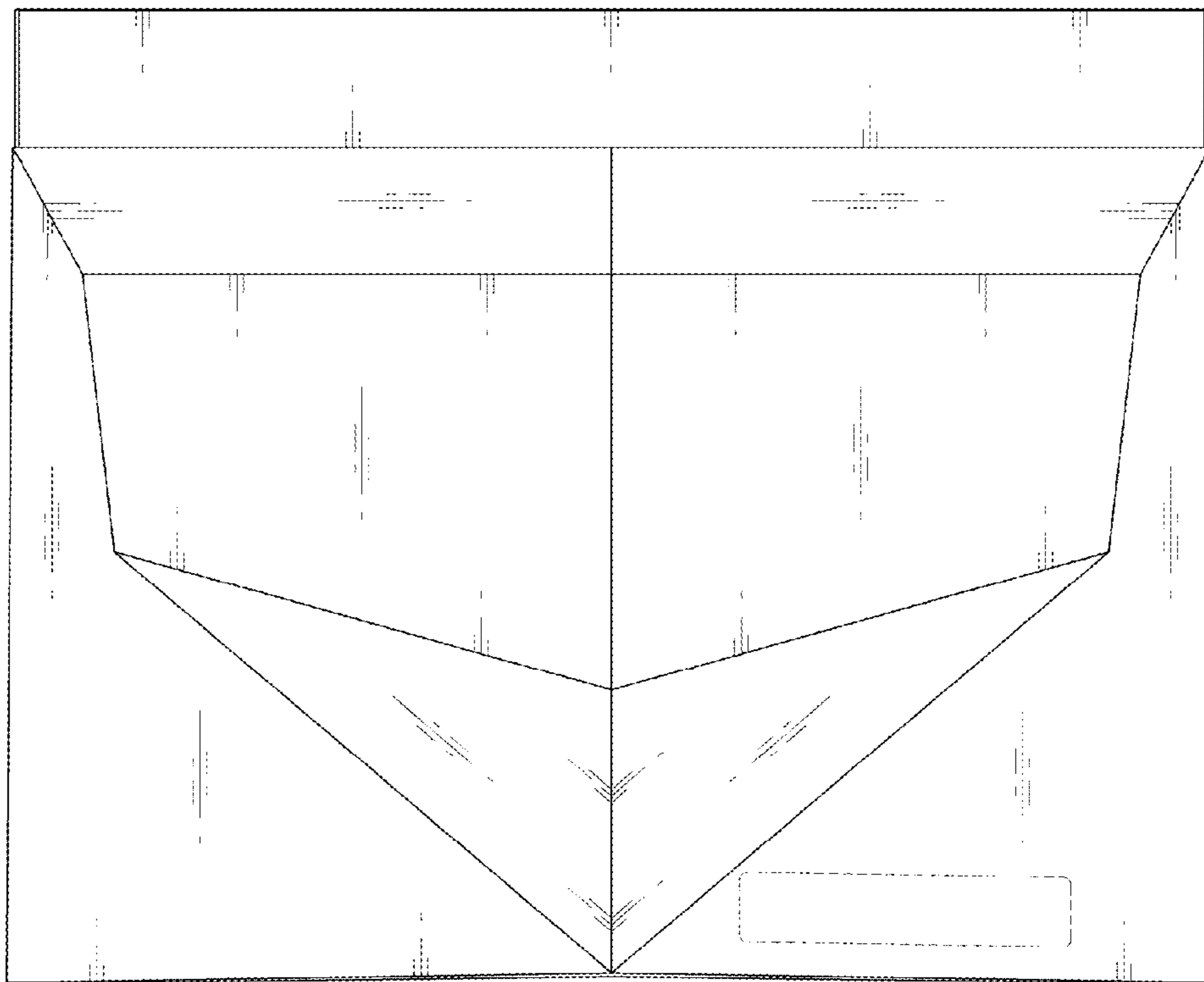

FIG. 19

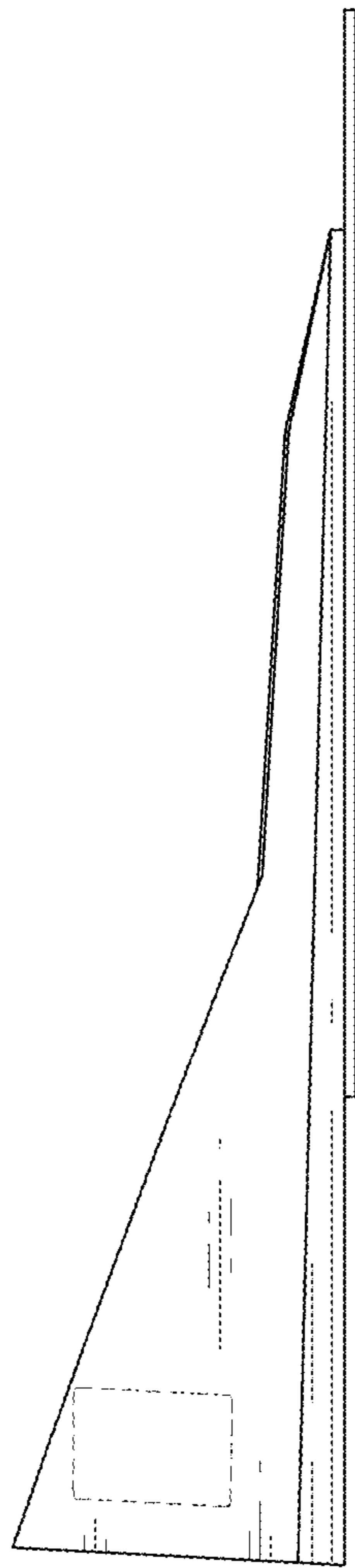

FIG. 20

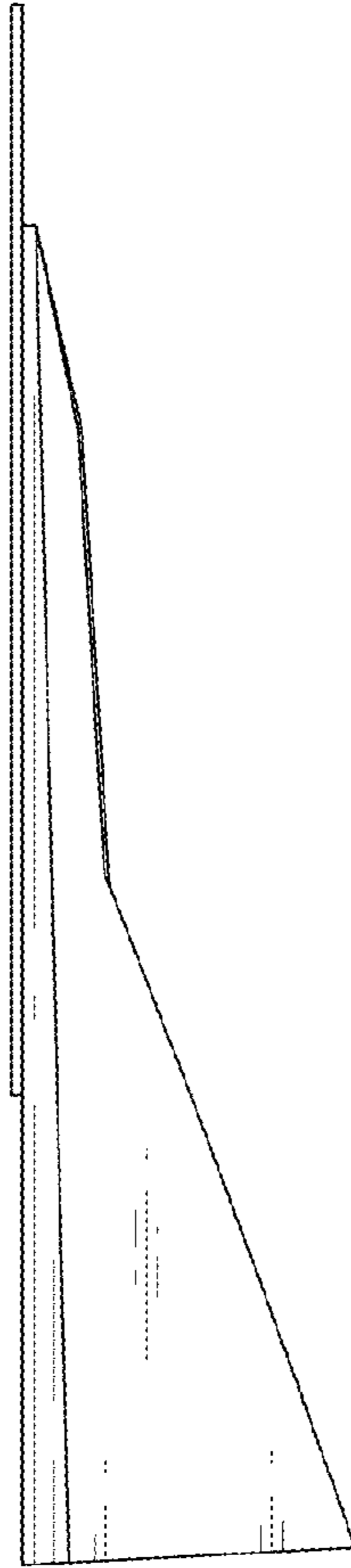

FIG. 21

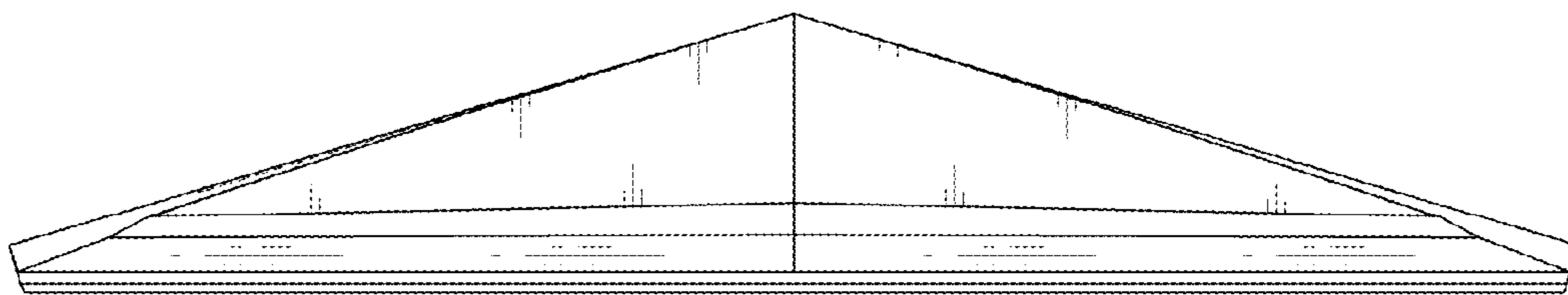

FIG. 22

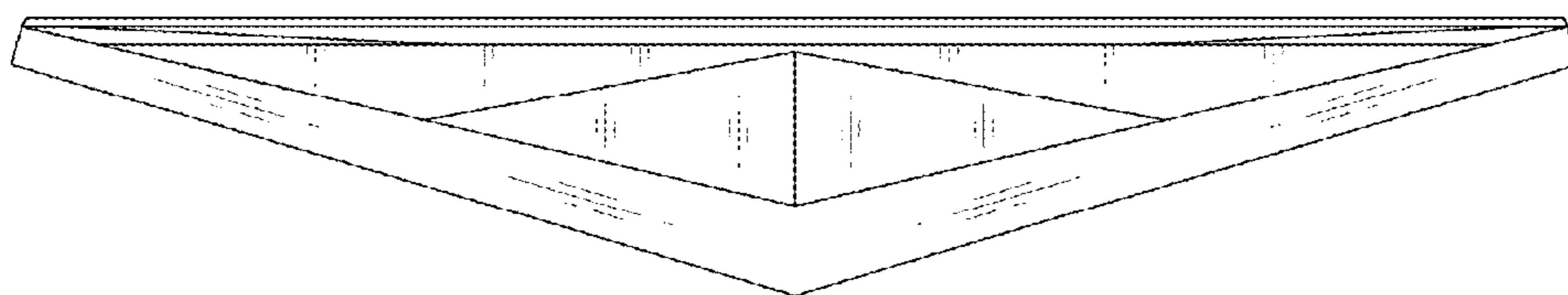

FIG. 23

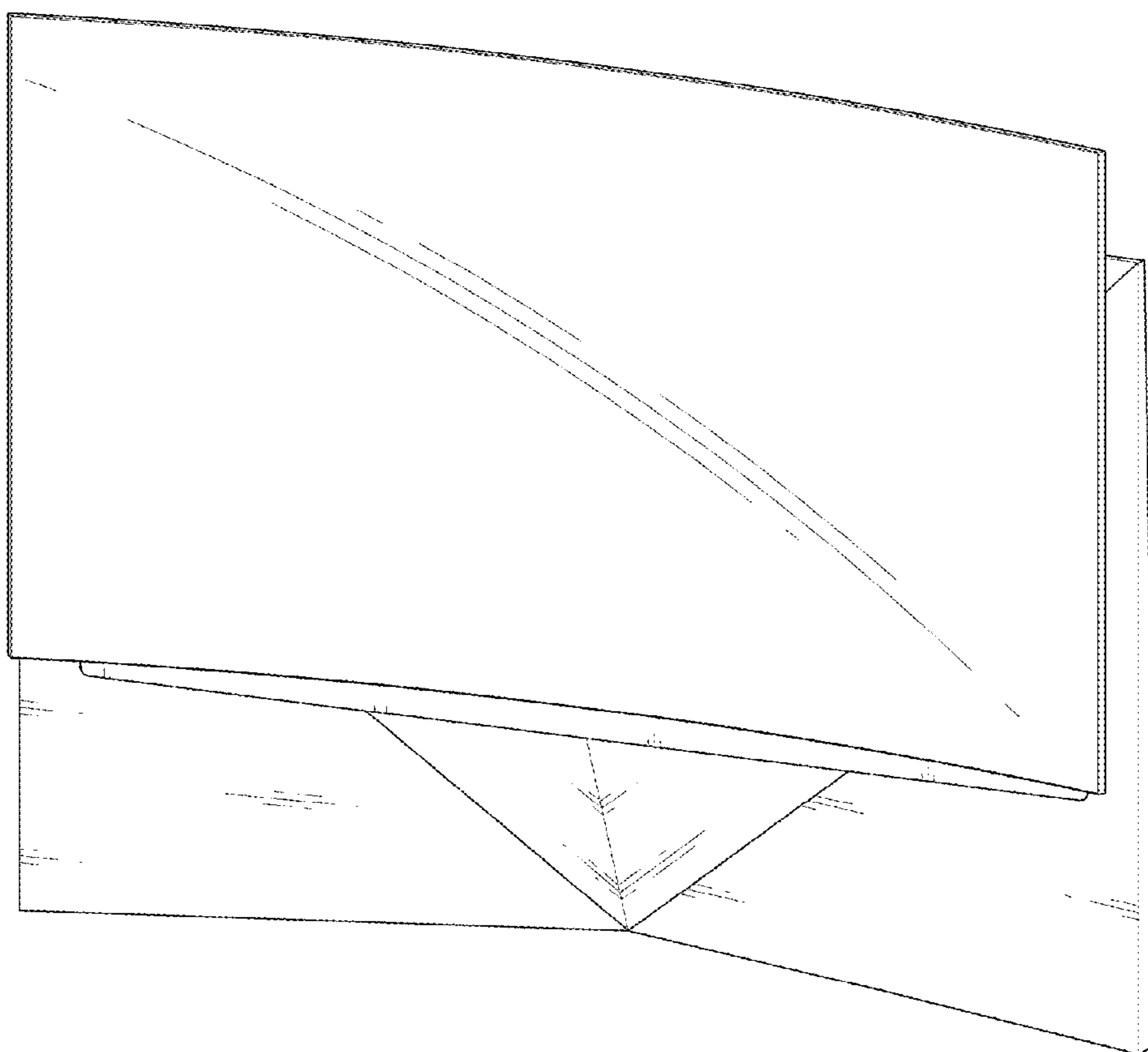

FIG. 24

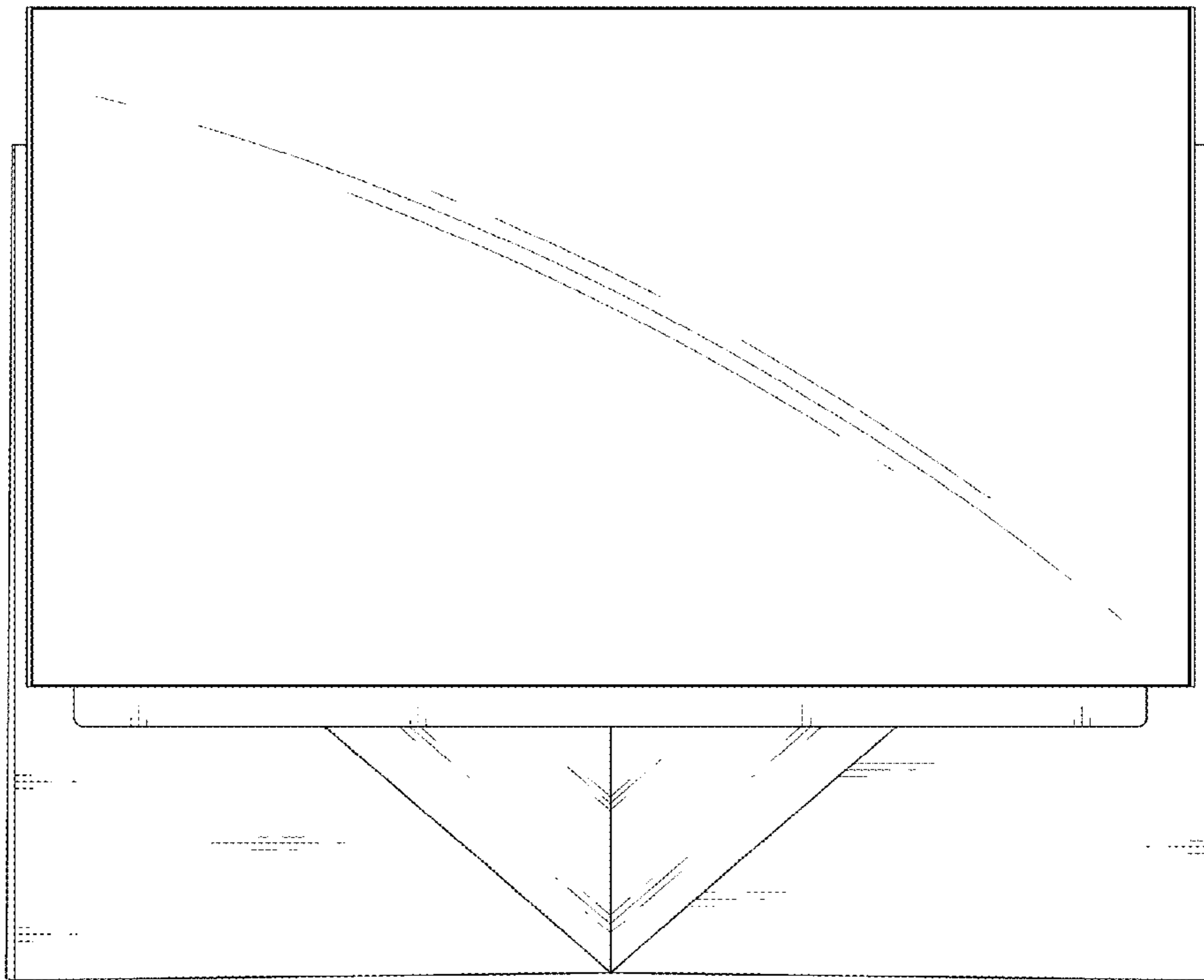

FIG. 25

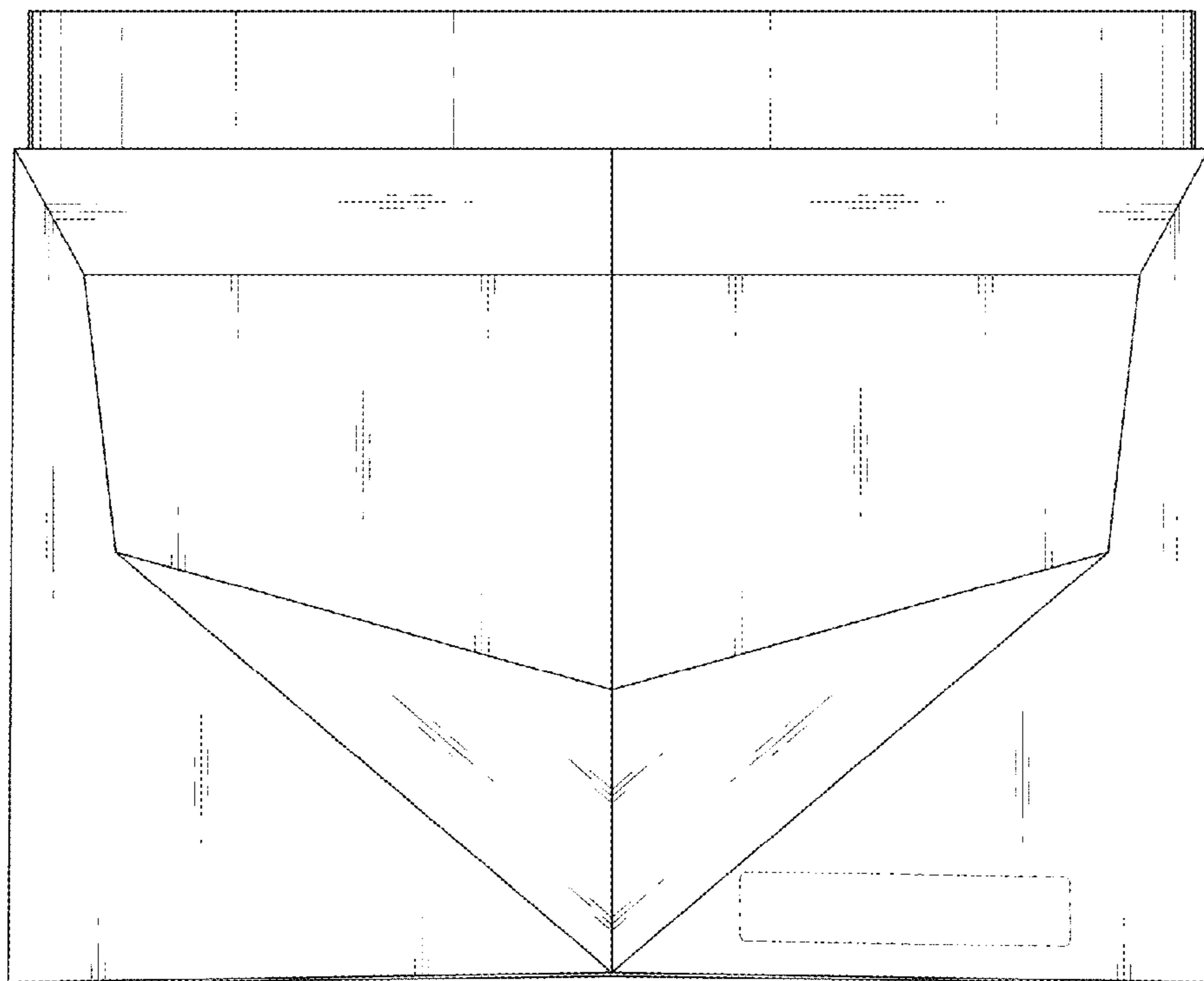

FIG. 26

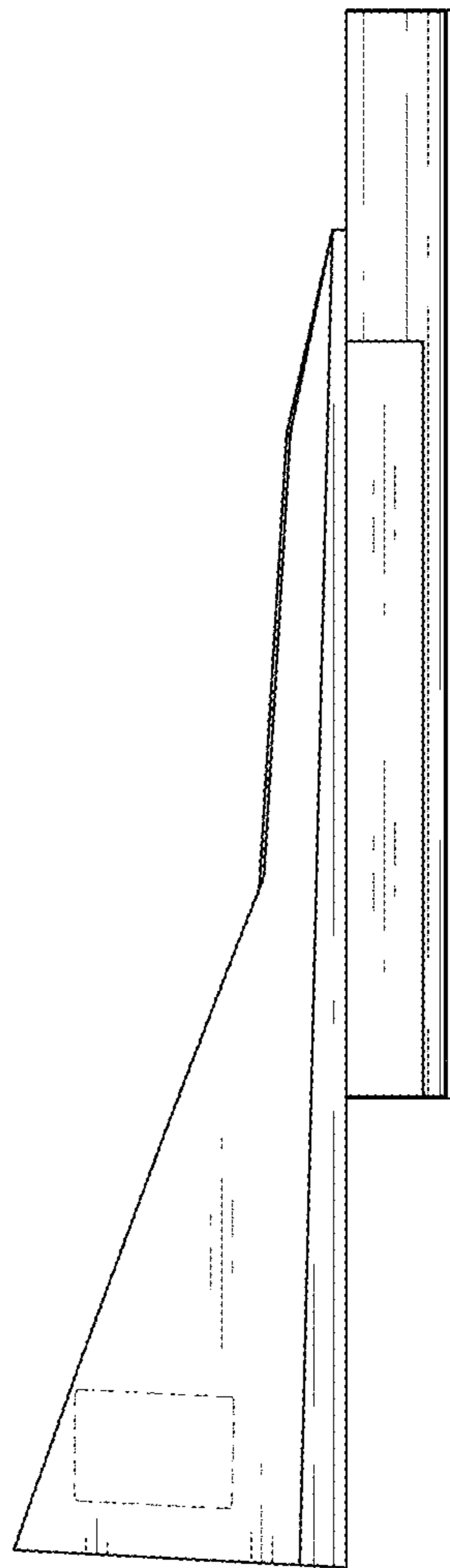

FIG. 27

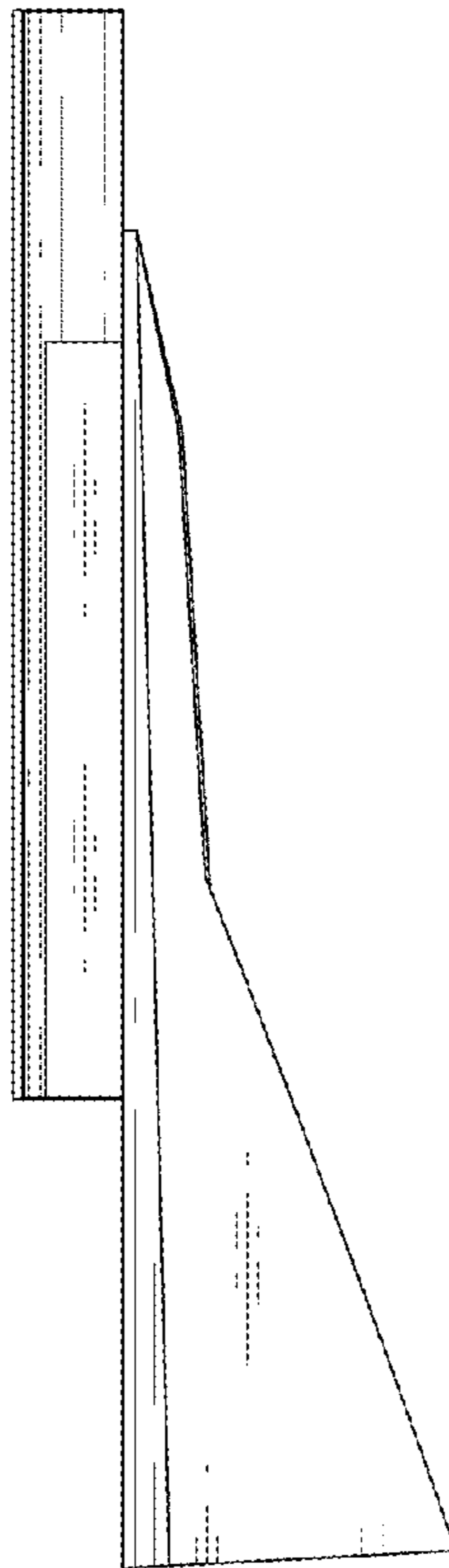

FIG. 28

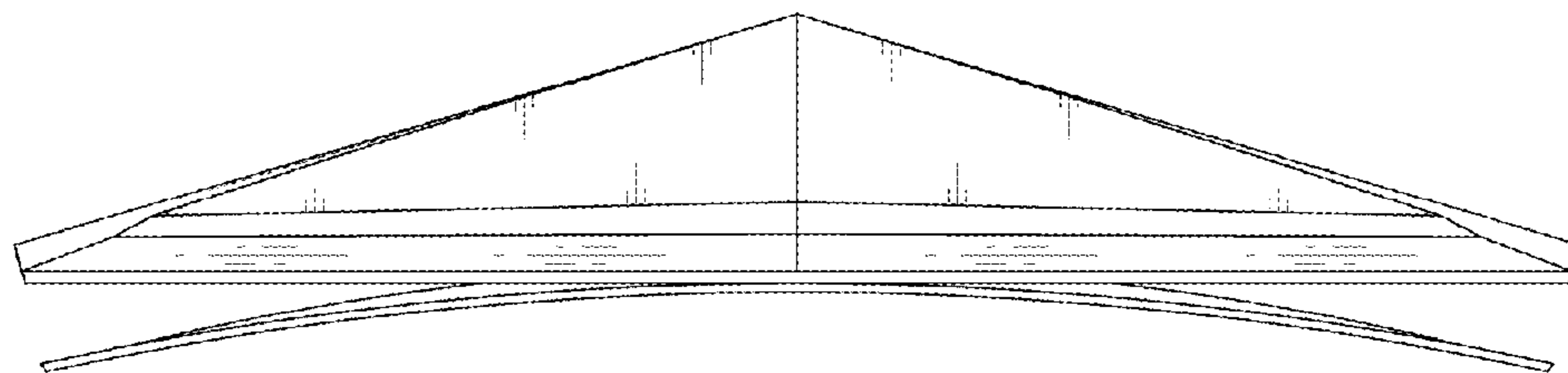

FIG. 29

