



US00D759536S

(12) **United States Design Patent**
Hardy

(10) **Patent No.:** **US D759,536 S**
(45) **Date of Patent:** **** Jun. 21, 2016**

(54) **PENDANT**

(71) Applicant: **CARTIER CREATION STUDIO SA,**
Geneva (CH)

(72) Inventor: **Théodora Hardy,** Paris (FR)

(73) Assignee: **Cartier International AG,** Steinhausen
(CH)

(**) Term: **14 Years**

(21) Appl. No.: **29/526,117**

(22) Filed: **May 6, 2015**

(51) **LOC (10) Cl.** **11-01**

(52) **U.S. Cl.**
USPC **D11/79**

(58) **Field of Classification Search**
USPC D11/1, 2, 7, 8, 40–44, 79–86, 90, 91,
D11/92, 93, 54, 56

CPC A44C 1/00; A44C 3/00; A44C 3/004;
A44C 3/005; A44C 3/007; A44C 3/008;
A44C 5/02; A44C 7/002; A44C 25/00;
A44C 25/001; A44C 25/002; A44C 25/004;
A44C 25/005; A44C 25/007

See application file for complete search history.

(56) **References Cited**

U.S. PATENT DOCUMENTS

D36,724 S * 1/1904 Levy D11/85
D97,535 S * 11/1935 Mossman, Jr. D11/80

D251,115 S * 2/1979 Rothenberg D11/81
D626,878 S * 11/2010 Hardy D11/79
D690,617 S * 10/2013 Lawlor D11/103
D695,643 S * 12/2013 Wolff D11/79
D736,665 S * 8/2015 Nemzer D11/79

OTHER PUBLICATIONS

[Online] http://bagaholicboy.com/wp-content/uploads/2014/03/cartier_amulette-de-cartier-collection3.jpg. Retrieved Jan. 1, 2016.*
[Online] http://i.luxury-insider.com/uploads/features/2012/09/give-the-gift-of-tiffany-co_5.jpg?width=650. Retrieved Jan. 1, 2016.*

* cited by examiner

Primary Examiner — Garth Rademaker

Assistant Examiner — Melanie Pellegrini

(74) *Attorney, Agent, or Firm* — Taft Stettinius & Hollister
LLP

(57) **CLAIM**

The ornamental design for a pendant, as shown and described.

DESCRIPTION

FIG. 1 is a front perspective view of a pendant of the present invention.

FIG. 2 is a front view of the pendant of FIG. 1.

FIG. 3 is a rear view of the pendant of FIG. 1.

FIG. 4 is a left side view of the pendant of FIG. 1.

FIG. 5 is a right side view of the pendant of FIG. 1.

FIG. 6 is a bottom view of the pendant of FIG. 1; and,

FIG. 7 is a top view of the pendant of FIG. 1.

1 Claim, 2 Drawing Sheets

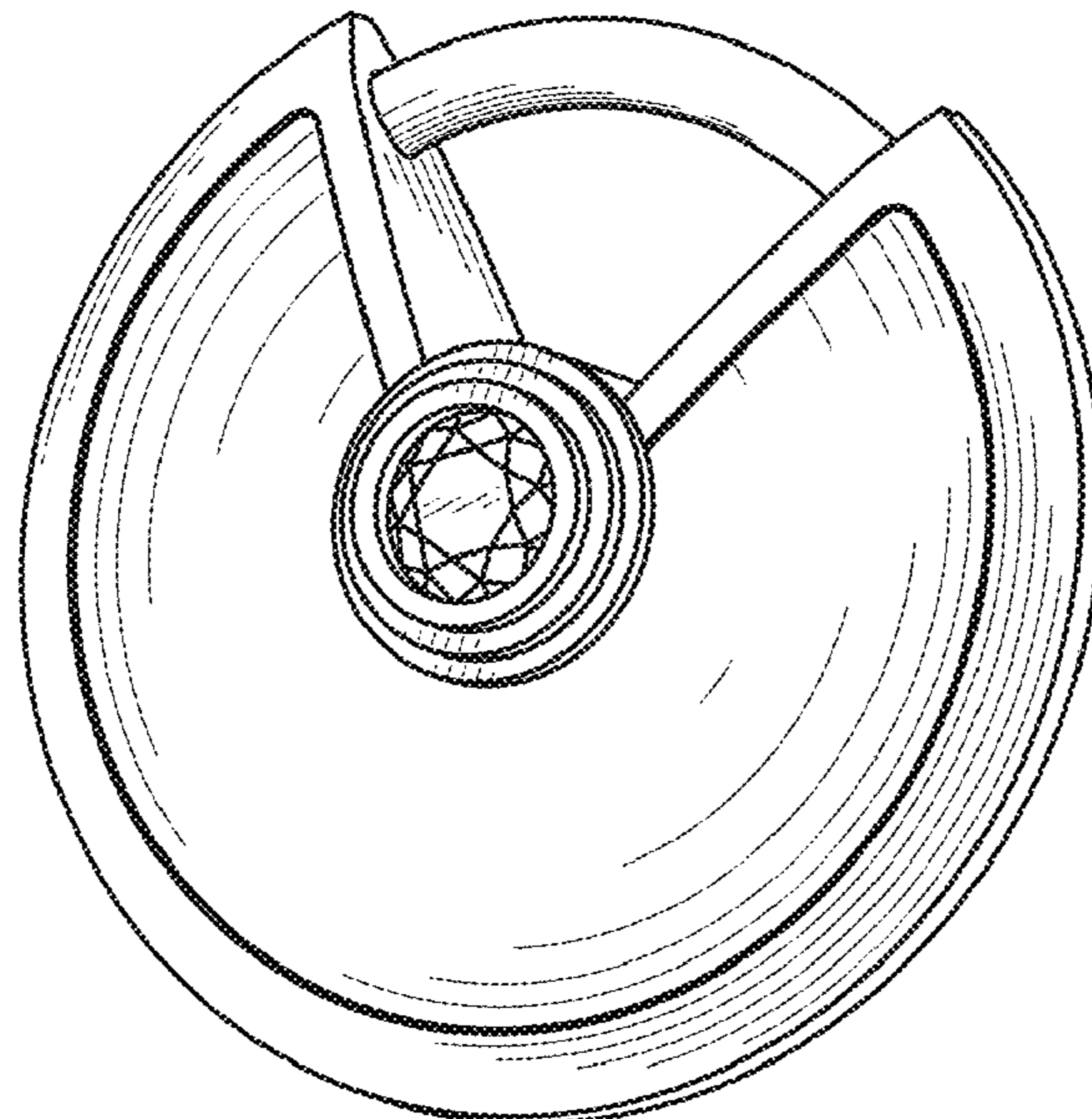

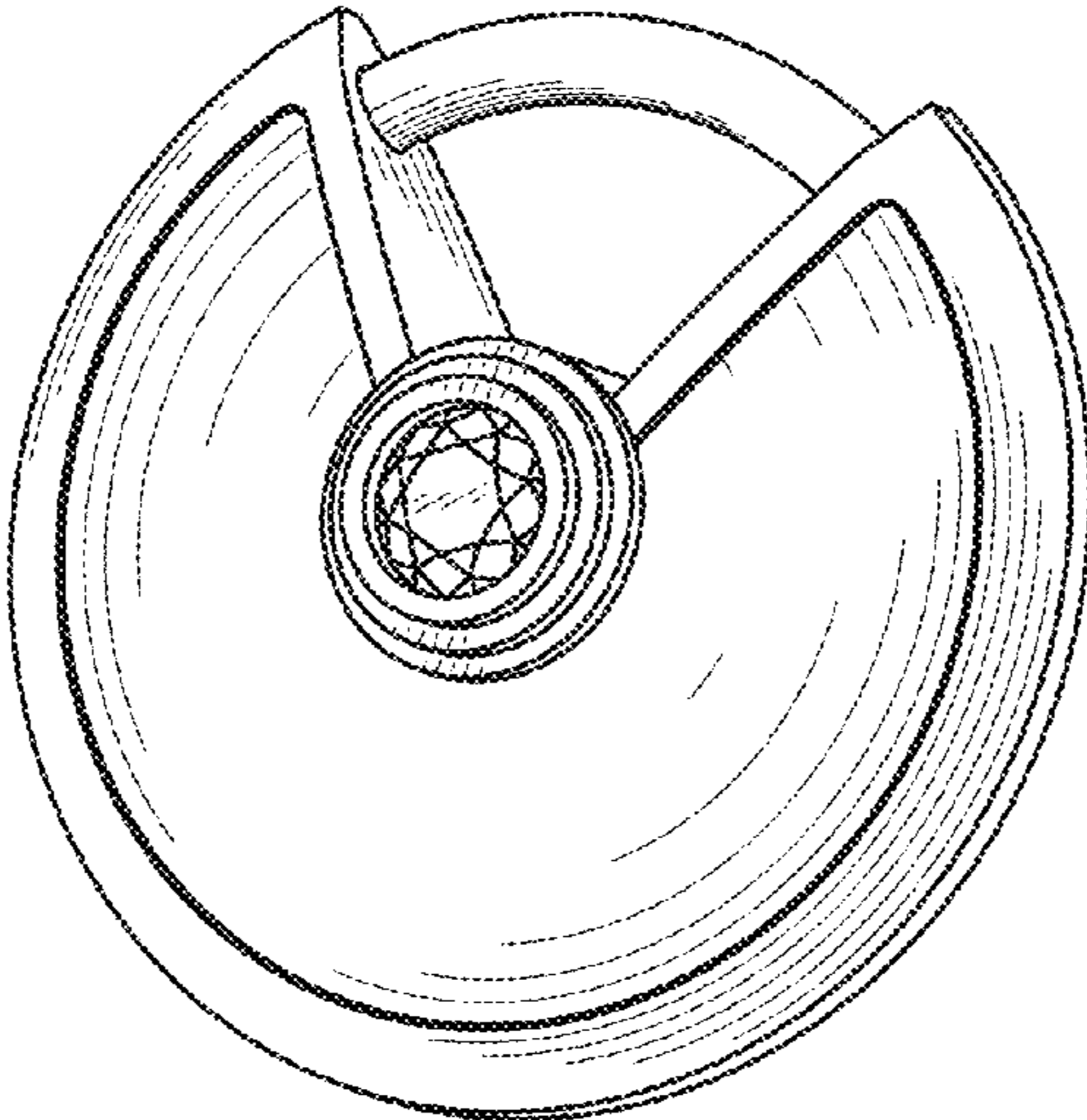

FIG. 1

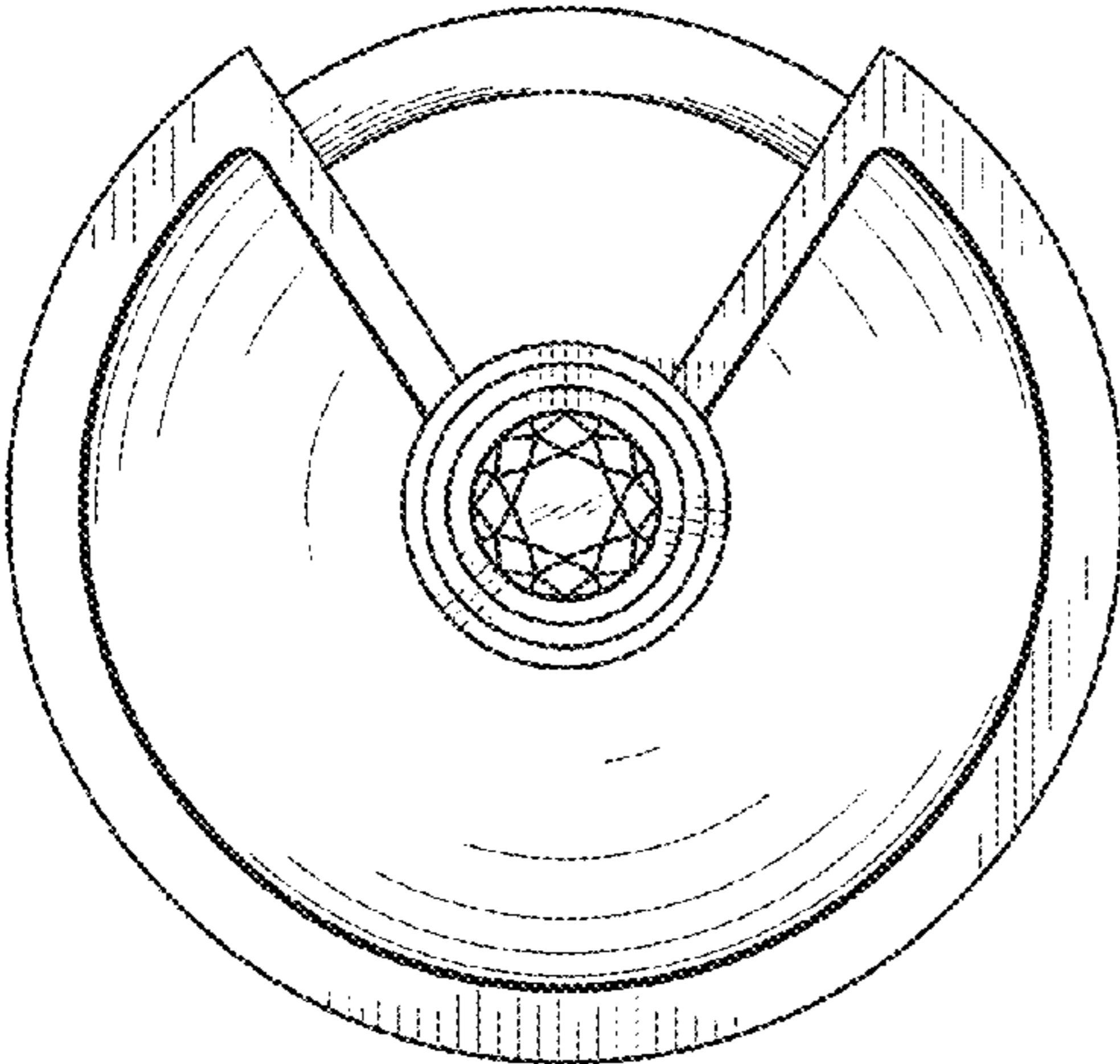

FIG. 2

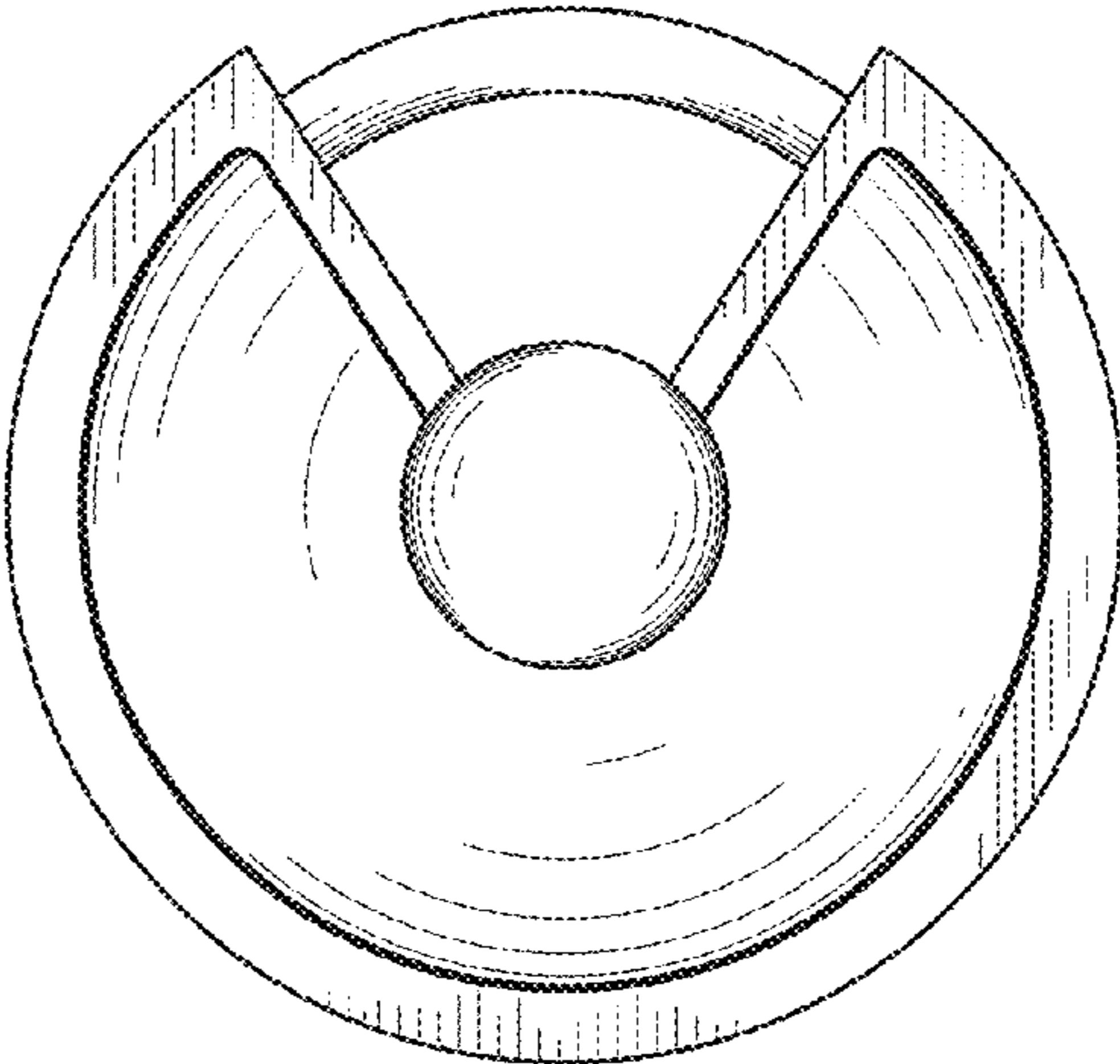

FIG. 3

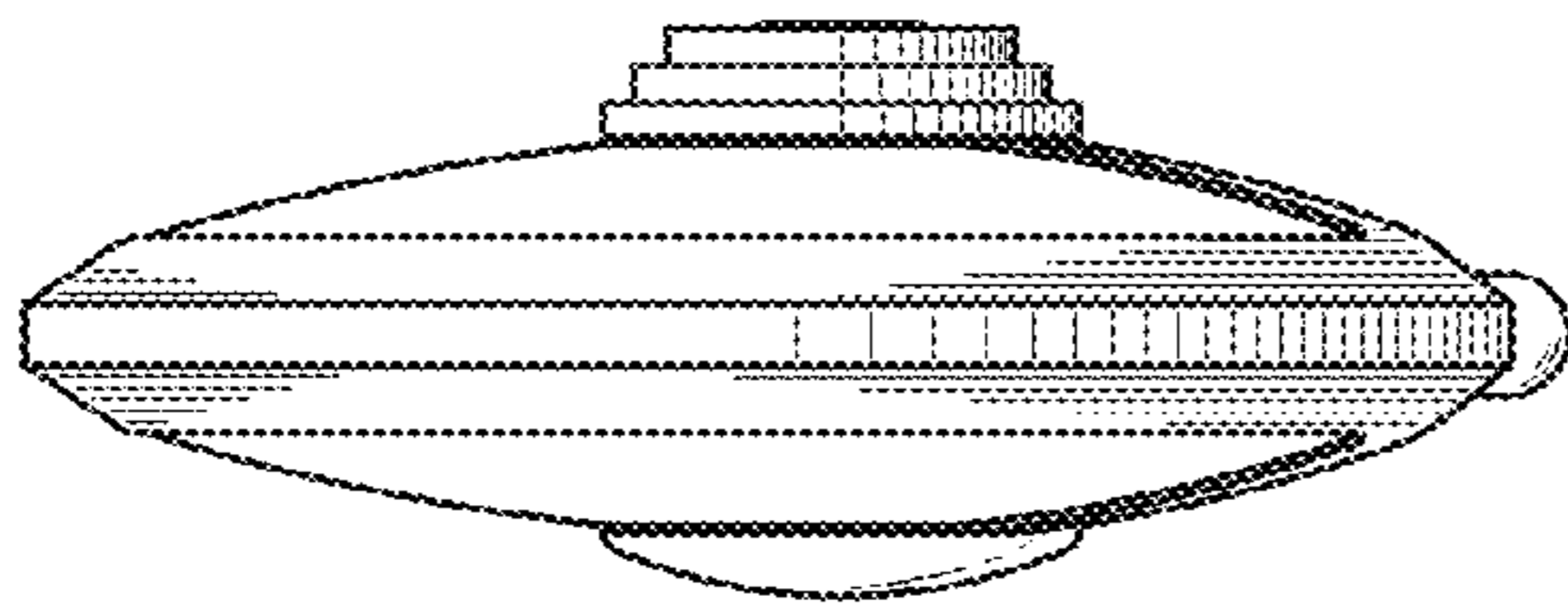

FIG. 4

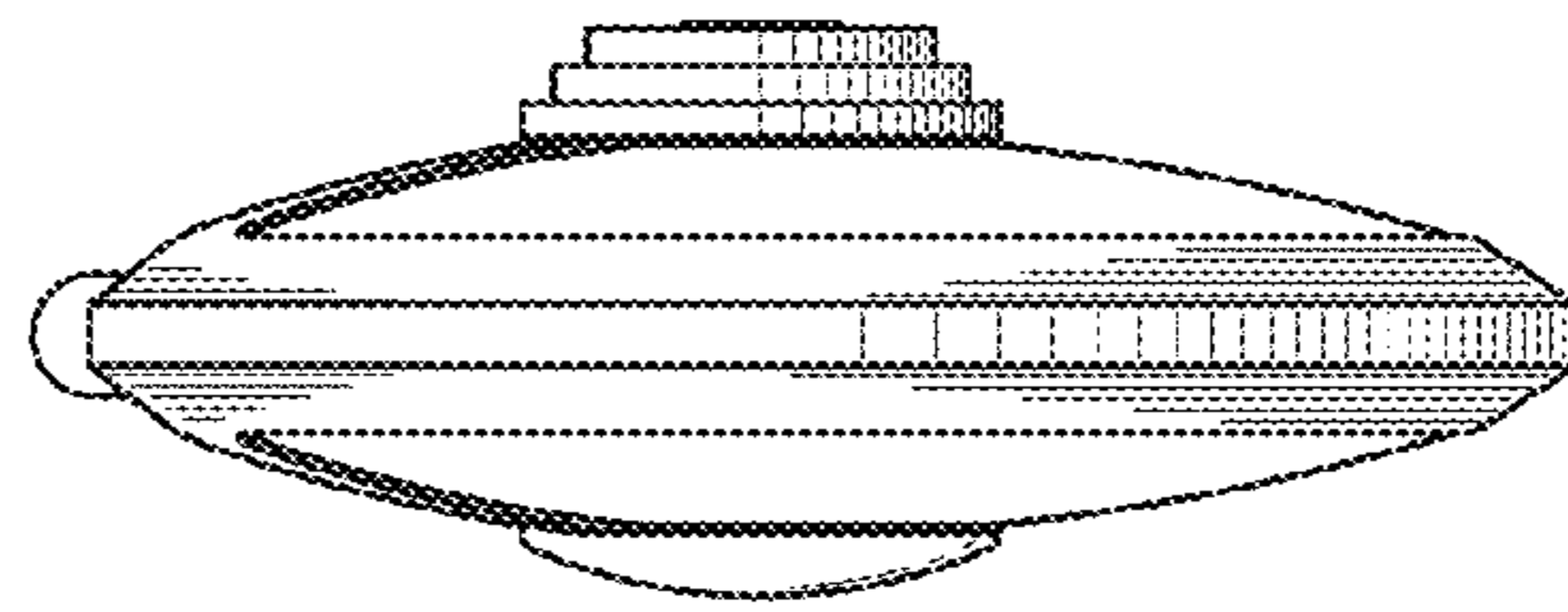

FIG. 5

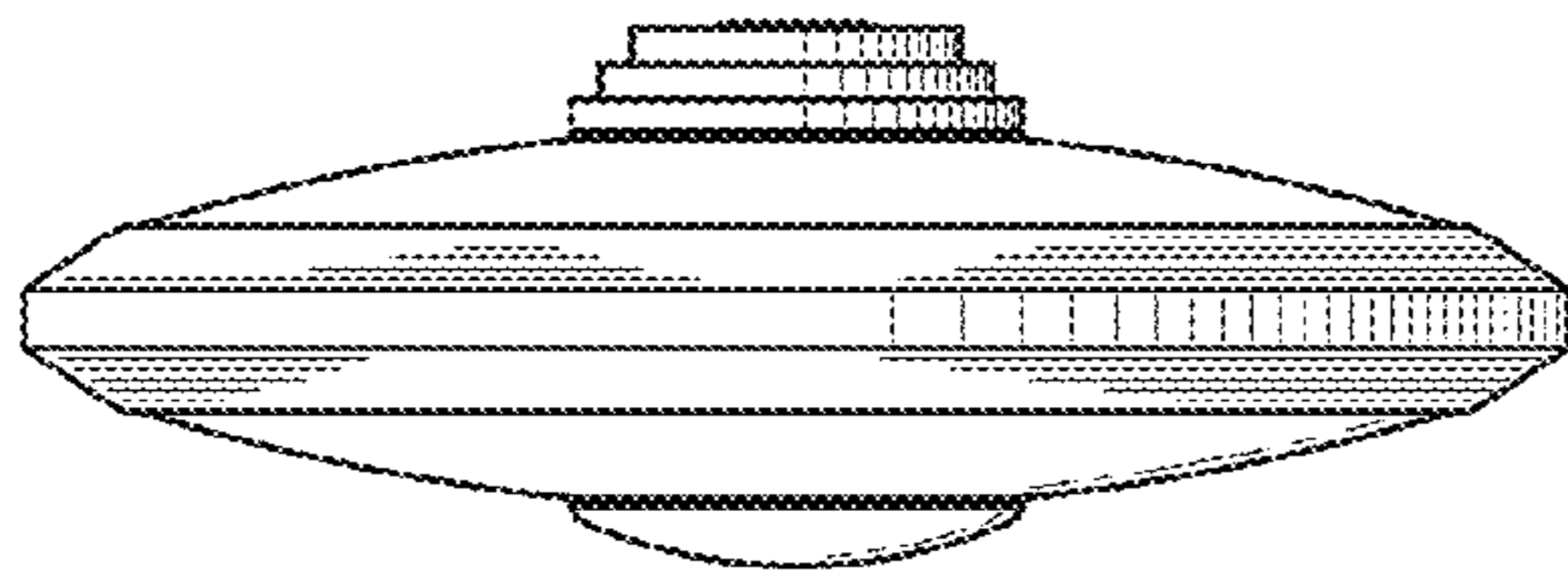

FIG. 6

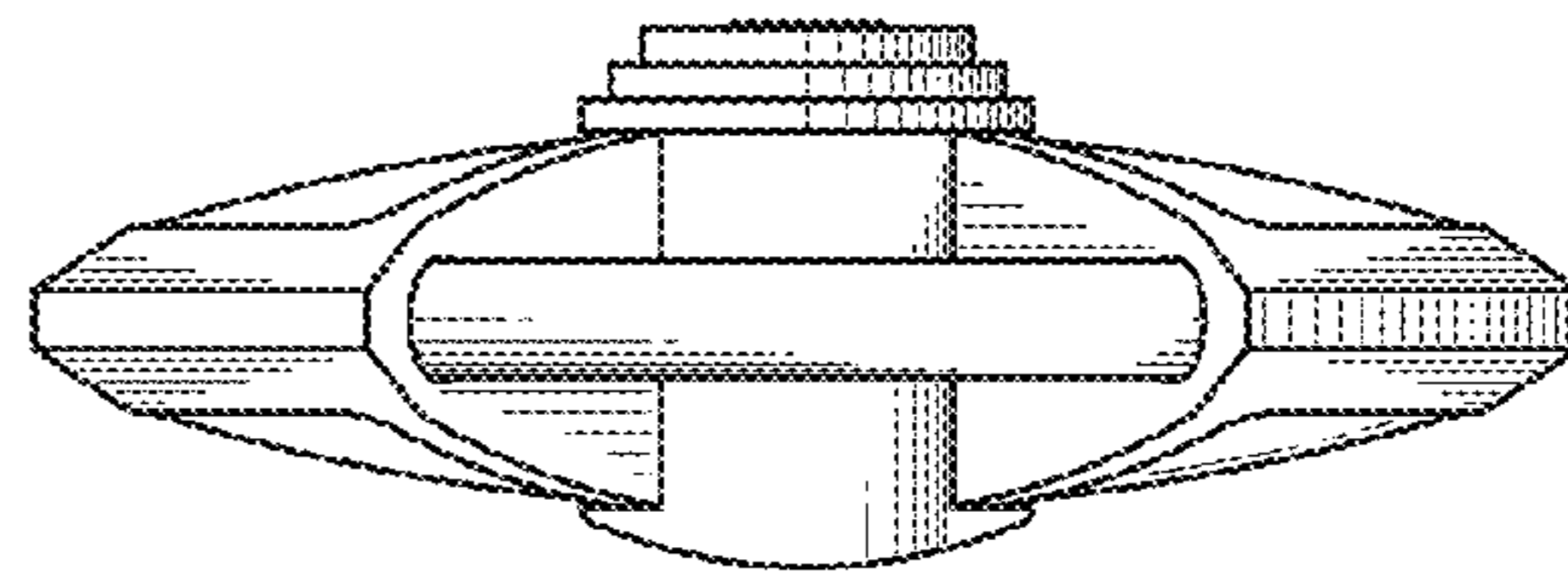

FIG. 7