

US00D759526S

(12) **United States Design Patent**
Rabassa

(10) **Patent No.:** **US D759,526 S**
(45) **Date of Patent:** **** Jun. 21, 2016**

(54) **DECORATIVE ELEMENT FOR WATCH**

(71) Applicant: **Cartier Creation Studio SA**, Geneva
(CH)

(72) Inventor: **Serge Rabassa**, Vessy (CH)

(73) Assignee: **Cartier International AG**, Steinhausen
(CH)

(**) Term: **15 Years**

(21) Appl. No.: **29/530,837**

(22) Filed: **Jun. 19, 2015**

(30) **Foreign Application Priority Data**

Dec. 19, 2014 (WO) DM/085 216

(51) **LOC (10) Cl.** **10-07**

(52) **U.S. Cl.**
USPC **D10/122; D10/34**

(58) **Field of Classification Search**
USPC D10/30-39, 1-29, 122-132; D11/4, 27,
D11/30, 31, 49, 52, 82, 202, 206; D21/617,
D21/618

CPC G04B 19/00; G04B 19/04; G04B 19/10;
G04B 37/00; G04B 37/0008; G04B 37/0058;
G04B 37/12; G04B 45/00; G04B 45/0046;
G04B 45/0076

See application file for complete search history.

(56) **References Cited**

U.S. PATENT DOCUMENTS

D17,109 S * 2/1887 Rapp D10/34
D72,359 S * 4/1927 Dinhofer D10/34
D126,610 S * 4/1941 Lerman D10/7
D162,358 S * 3/1951 Spier D10/7

2,988,870 A * 6/1961 Tupone G04B 45/0046
368/229
D311,157 S * 10/1990 Boivin D11/202
D324,653 S * 3/1992 Mandelli D10/34
D324,654 S * 3/1992 Mandelli D10/34
D341,797 S * 11/1993 Perrin D11/206
D401,161 S * 11/1998 Perrin D10/34
D475,944 S * 6/2003 Jordan D11/52
D536,633 S * 2/2007 Arlanda D11/30
D612,282 S * 3/2010 Iacomucci D11/4
D612,284 S * 3/2010 Iacomucci D11/31
D640,949 S * 7/2011 Iacomucci D11/31
D671,857 S * 12/2012 Rabassa D10/126
D680,024 S * 4/2013 Le Bail D11/49
D684,484 S * 6/2013 Chastaingt D10/34
D692,343 S * 10/2013 Hardy D11/82
D718,174 S * 11/2014 Le Bail D11/27

* cited by examiner

Primary Examiner — Martie K Holtje

(74) *Attorney, Agent, or Firm* — Taft Stettinius & Hollister
LLP

(57) **CLAIM**

The ornamental design for a decorative element for watch, as
shown and described.

DESCRIPTION

FIG. 1 is a front elevational view of a decorative element for
watch showing my new design;

FIG. 2 is a rear elevational view thereof;

FIG. 3 is a left side elevational view thereof;

FIG. 4 is a right side elevational view thereof;

FIG. 5 is a top plan view thereof;

FIG. 6 is a bottom plan view thereof; and,

FIG. 7 is a right front perspective view thereof.

The watch depicted by broken lines in the drawings has been
shown for the purpose of illustrating environment that forms
no part of the claimed design.

1 Claim, 2 Drawing Sheets

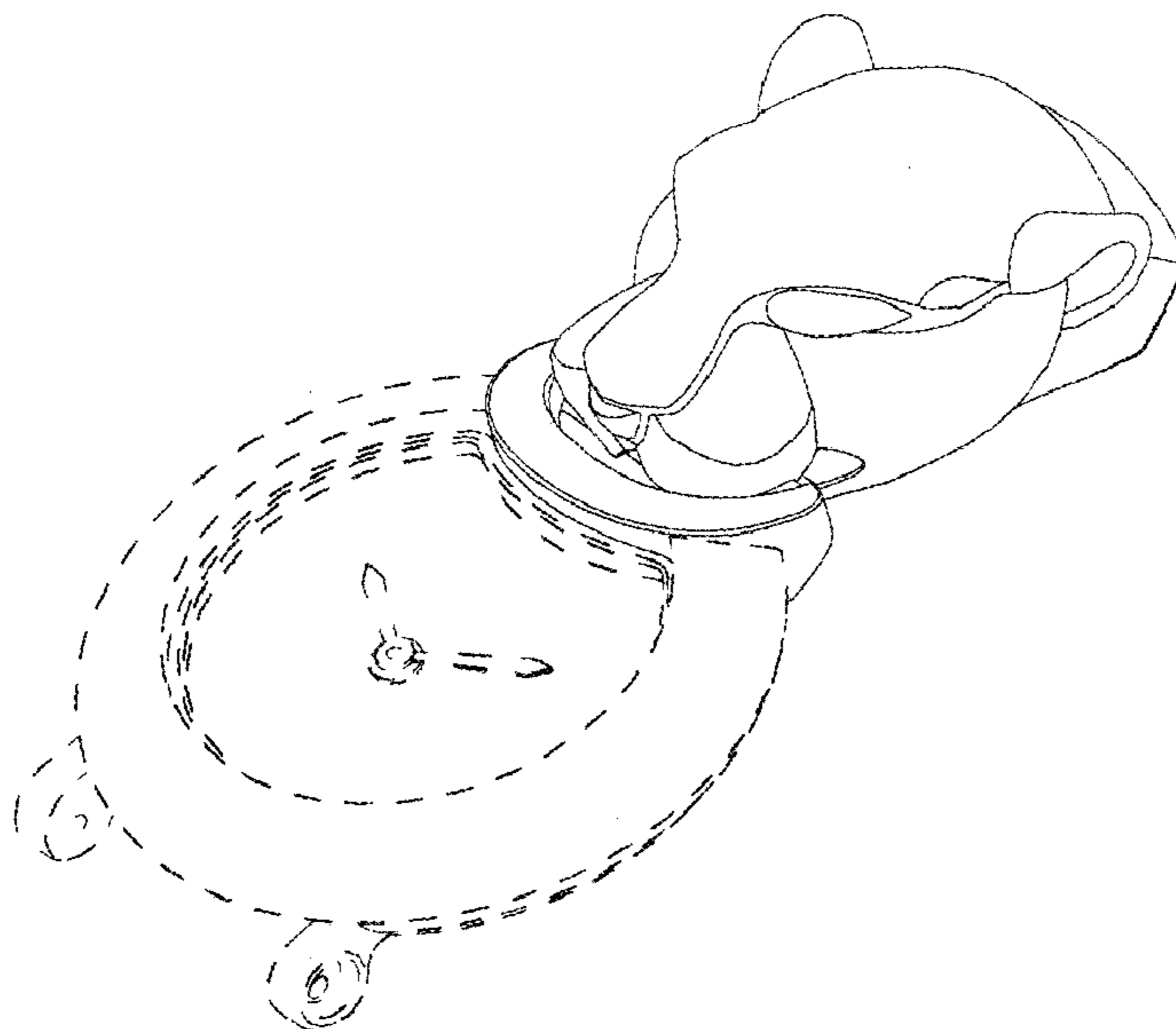

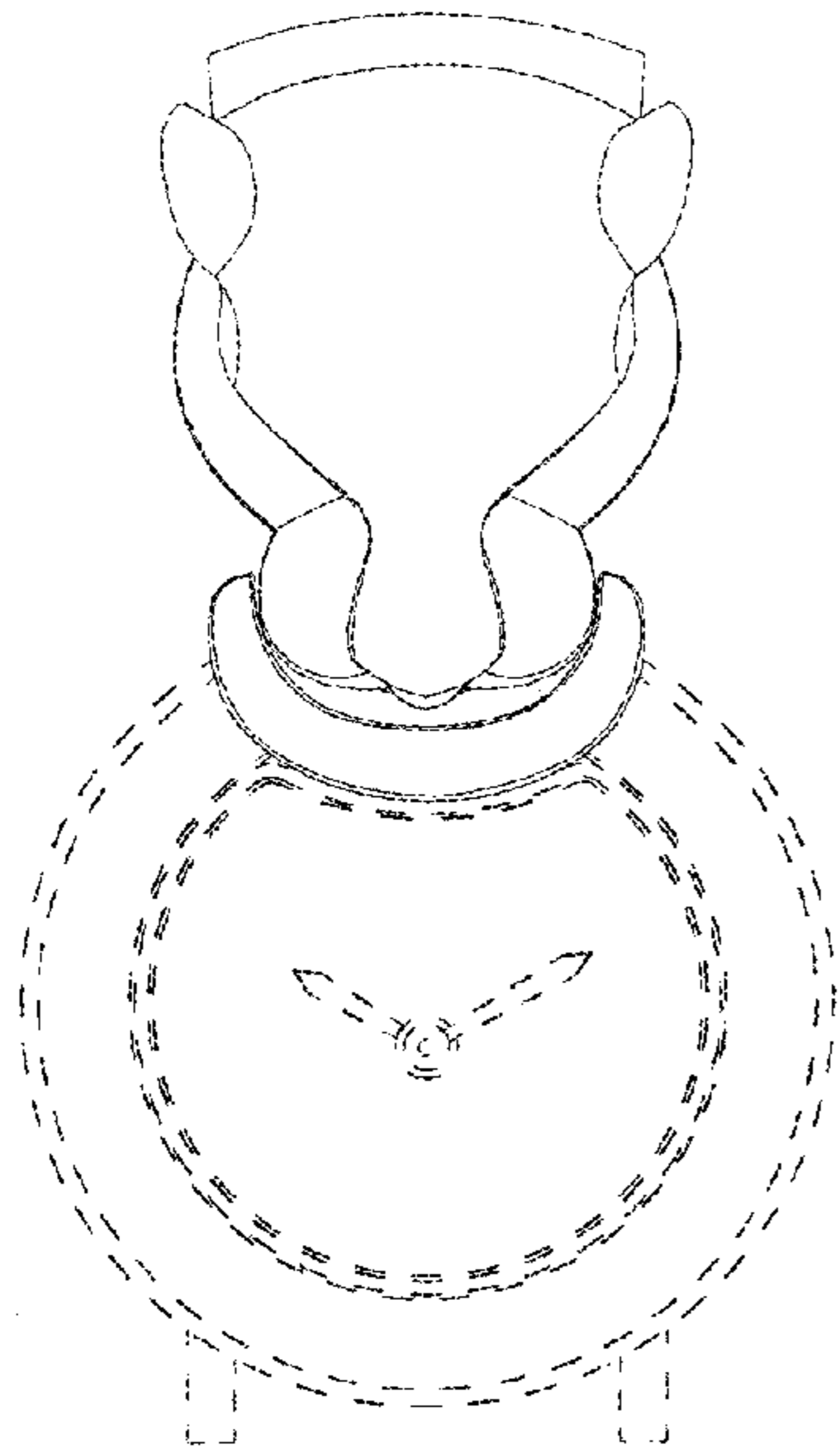

Fig. 1

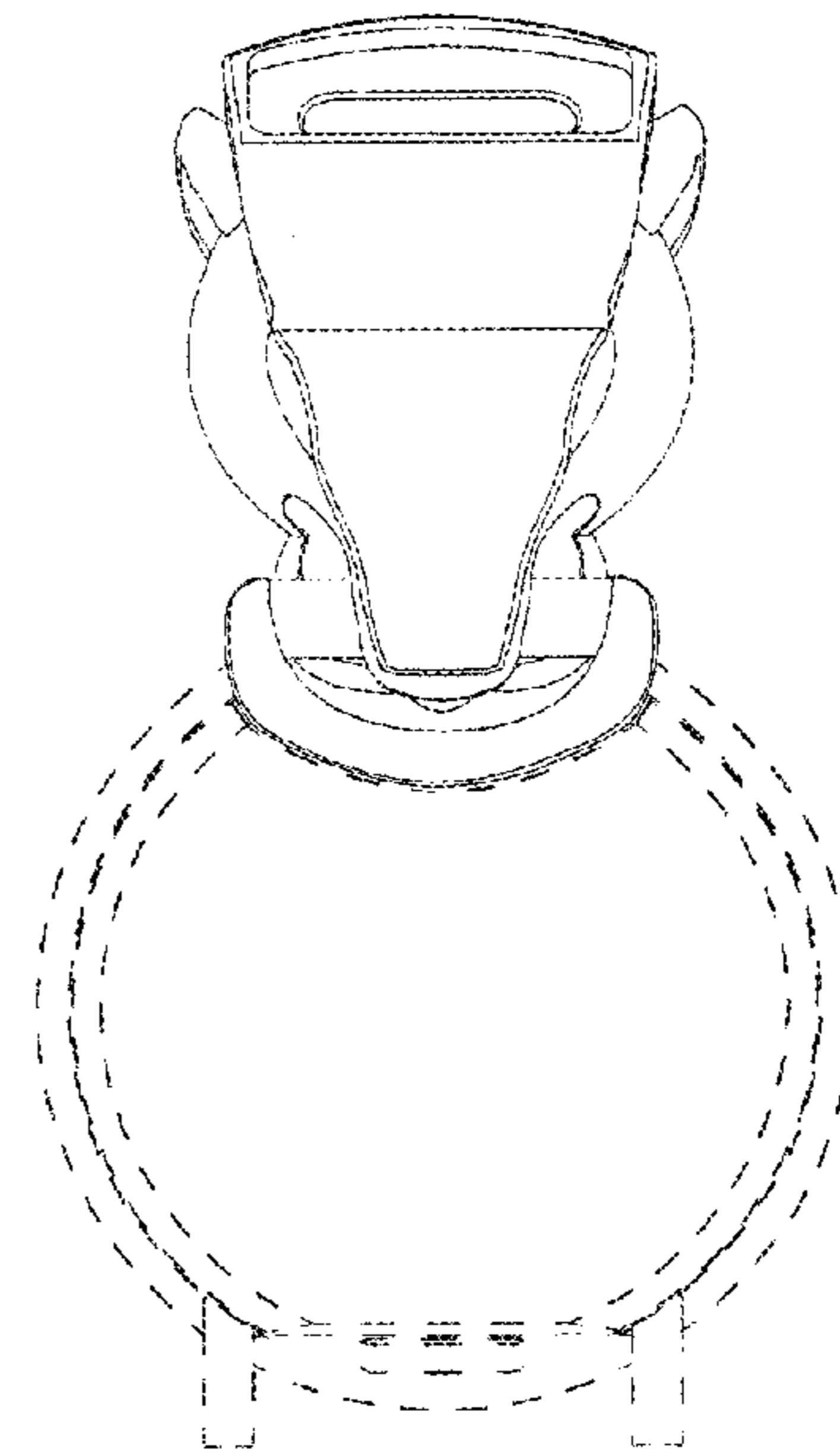

Fig. 2

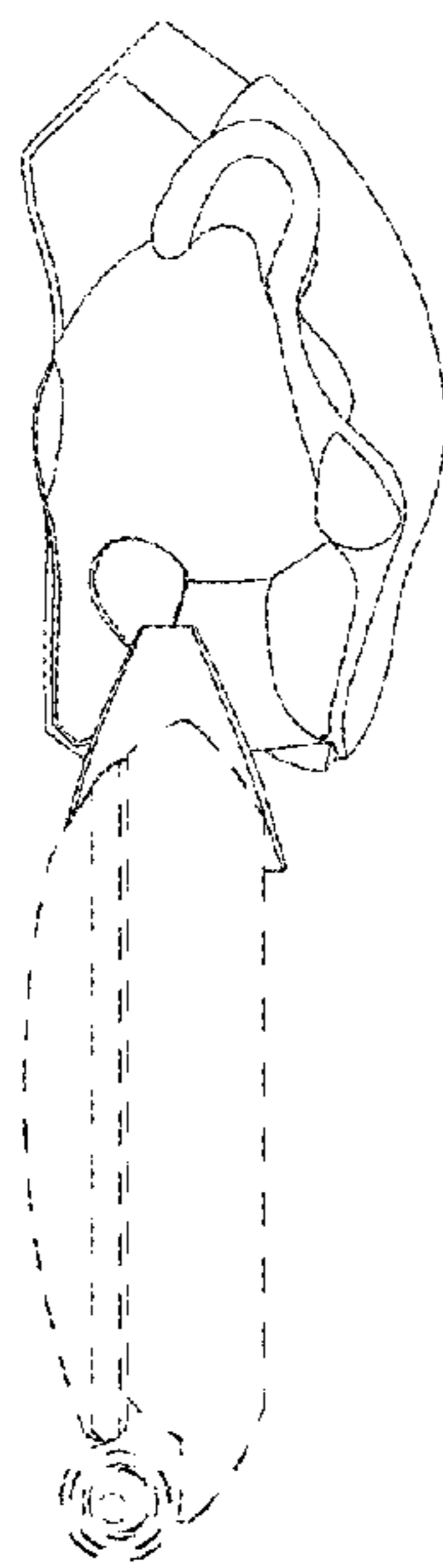

Fig. 3

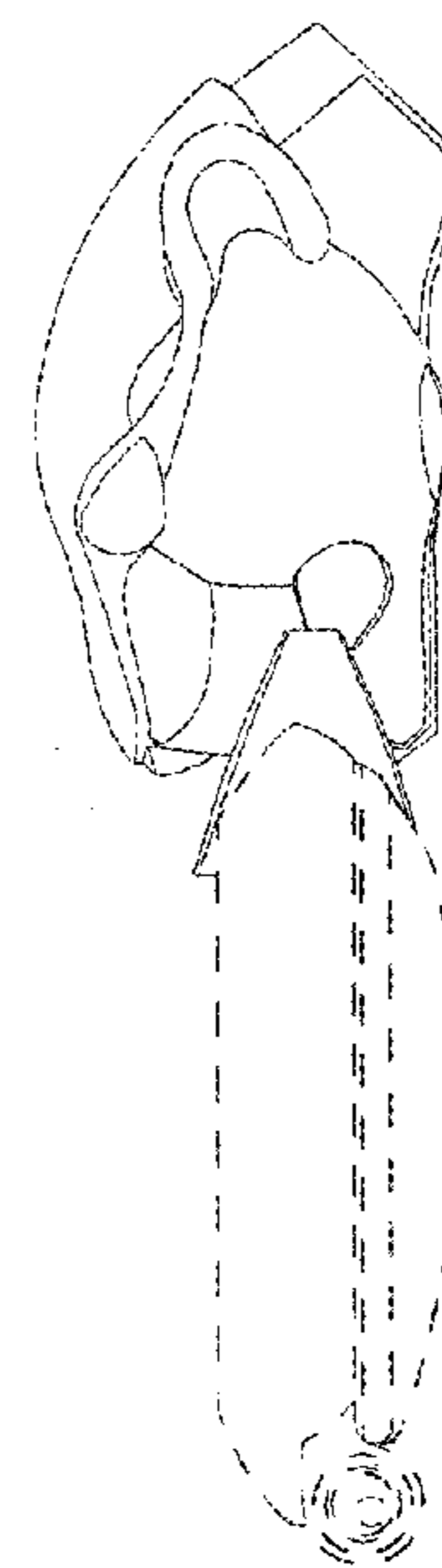

Fig. 4

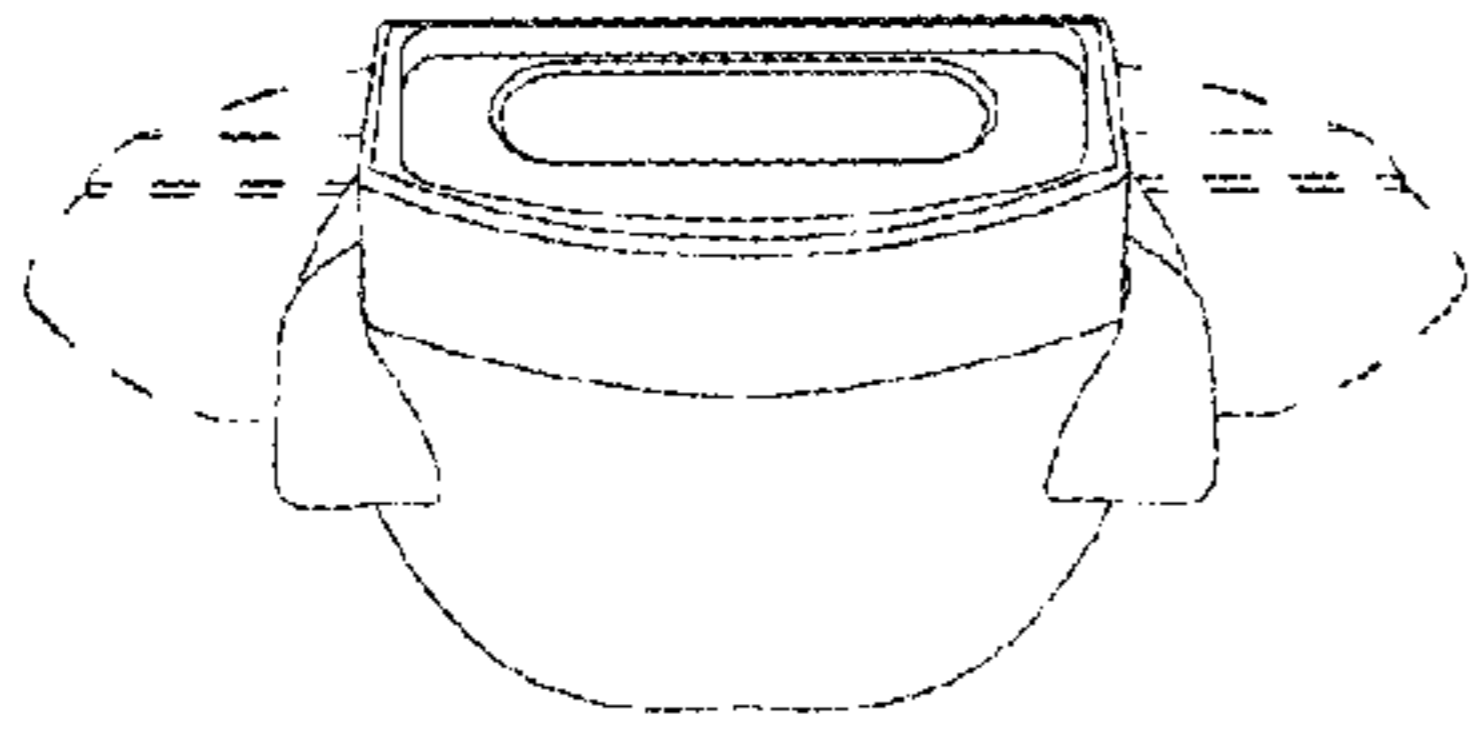

Fig. 5

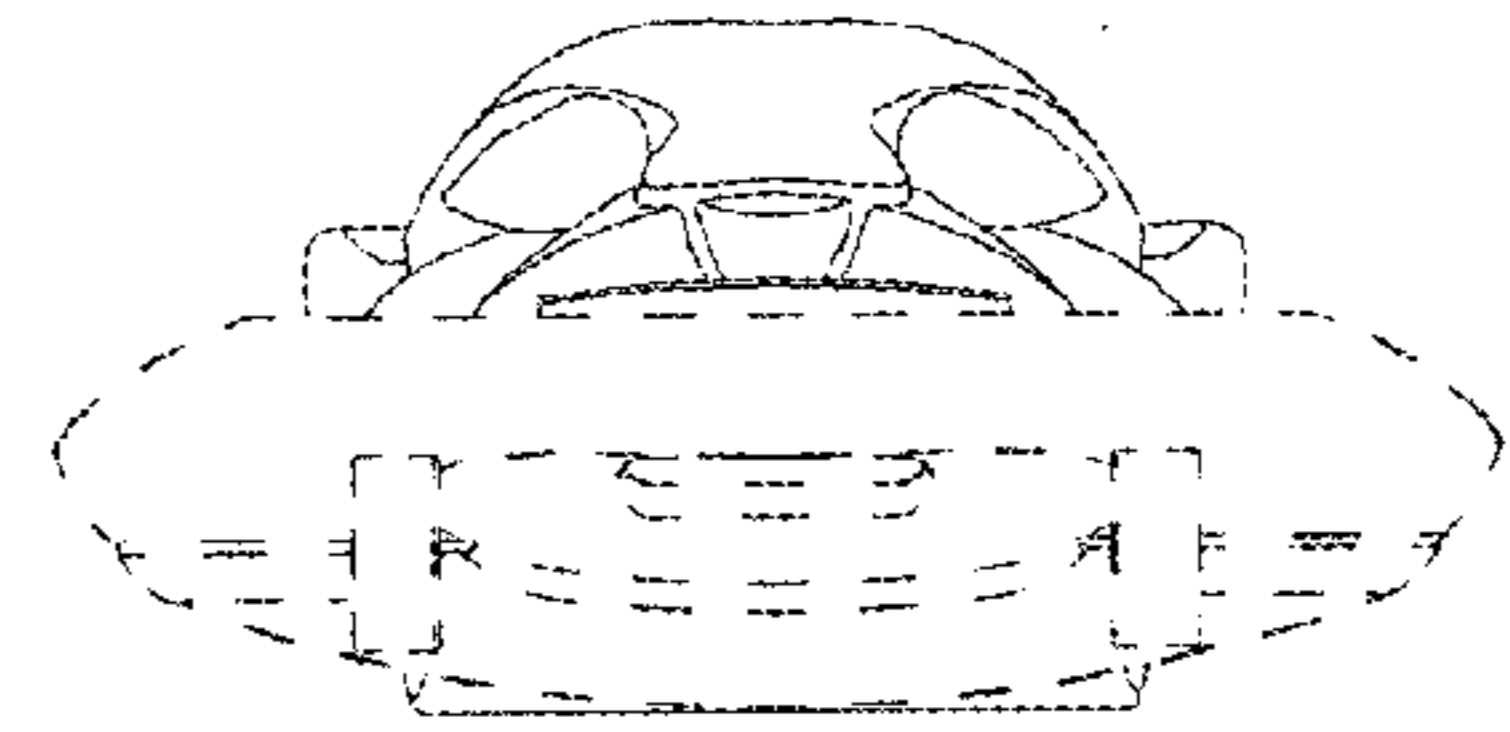

Fig. 6

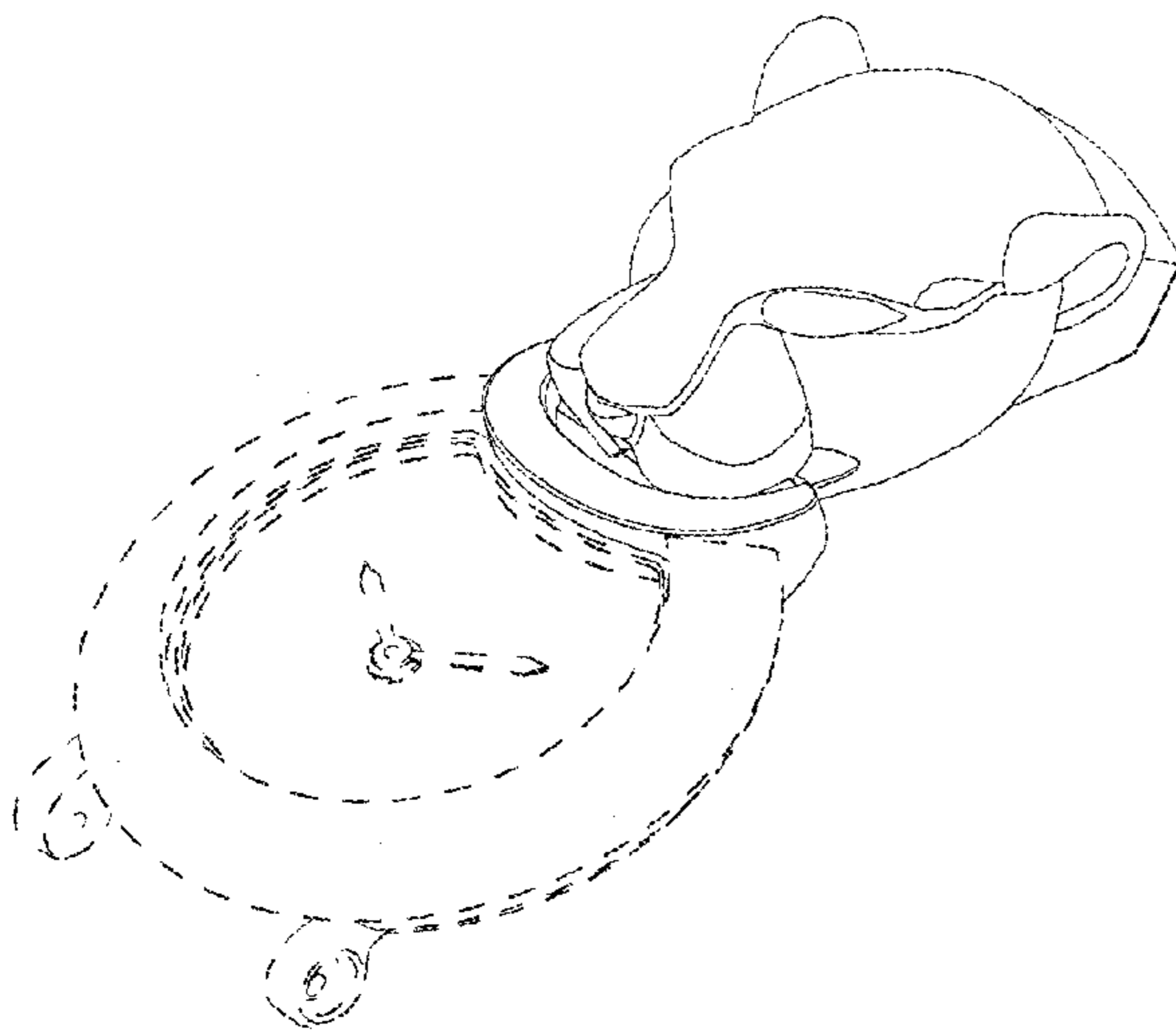

Fig. 7