



US00D759505S

(12) **United States Design Patent**
Harada

(10) **Patent No.:** **US D759,505 S**
(45) **Date of Patent:** **** Jun. 21, 2016**

(54) **WRISTWATCH CASE WITH BAND**

(71) Applicant: **Seiko Watch Kabushiki Kaisha**, Tokyo (JP)

(72) Inventor: **Aki Harada**, Tokyo (JP)

(73) Assignee: **Seiko Watch Kabushiki Kaisha** (JP)

(**) Term: **15 Years**

(21) Appl. No.: **29/528,618**

(22) Filed: **May 29, 2015**

(51) **LOC (10) Cl.** **10-02**

(52) **U.S. Cl.**
USPC **D10/32; D10/38; D11/13**

(58) **Field of Classification Search**
USPC D10/30-39, 1-29, 122-132; D11/3, 4, D11/5, 13
CPC G04B 19/00; G04B 19/14; G04B 19/18; G04B 37/00; G04B 37/0008; G04B 37/0058; G04B 37/1486; G04B 47/00; G04B 47/042; G04B 45/00; A44C 5/00; A44C 5/02; A44C 5/025; A44C 5/027; A44C 11/00
See application file for complete search history.

(56) **References Cited**

U.S. PATENT DOCUMENTS

3,545,197	A *	12/1970	Fischer	G04B 19/14 368/292
4,056,928	A *	11/1977	de Vries	A44C 11/00 59/83
4,855,972	A *	8/1989	Eiss	G04B 37/1486 224/170
D317,577	S *	6/1991	Eiss	D10/30
D386,979	S *	12/1997	Kubisch	D10/32
D423,950	S *	5/2000	Bulgari	D10/30
D465,422	S *	11/2002	Mantovani	D10/30
D504,332	S *	4/2005	Chodat	D10/39

D521,406	S *	5/2006	Strasser	D10/32
D567,678	S *	4/2008	Iff	D10/39
D568,197	S *	5/2008	Wartersian	D10/126
D586,240	S *	2/2009	Reginelli	D10/32
D613,637	S *	4/2010	Grassi Damiani	D11/13
D631,374	S *	1/2011	Hegi	D10/38
D642,076	S *	7/2011	Chastaingt	D10/39
D646,184	S *	10/2011	Duport	D10/39
D696,145	S *	12/2013	Stegmann	D10/38
D701,778	S *	4/2014	Duport	D10/32
D704,077	S *	5/2014	Monachon	D10/32
D716,154	S *	10/2014	Harada	D10/32

* cited by examiner

Primary Examiner — Martie K Holtje

(74) *Attorney, Agent, or Firm* — Saidman DesignLaw Group, LLC

(57) **CLAIM**

The ornamental design for a wristwatch case with band, as shown and described.

DESCRIPTION

FIG. 1 is a perspective view of a wristwatch case with band showing my new design;
FIG. 2 is a front elevational view thereof;
FIG. 3 is a rear elevational view thereof;
FIG. 4 is a top plan view thereof;
FIG. 5 is a bottom plan view thereof;
FIG. 6 is a left side elevational view thereof;
FIG. 7 is a right side elevational view thereof;
FIG. 8 is a perspective view of a second embodiment thereof;
FIG. 9 is a front elevational view thereof;
FIG. 10 is a rear elevational view thereof;
FIG. 11 is a top plan view thereof;
FIG. 12 is a bottom plan view thereof;
FIG. 13 is a left side elevational view thereof; and,
FIG. 14 is a right side elevational view thereof.

1 Claim, 10 Drawing Sheets

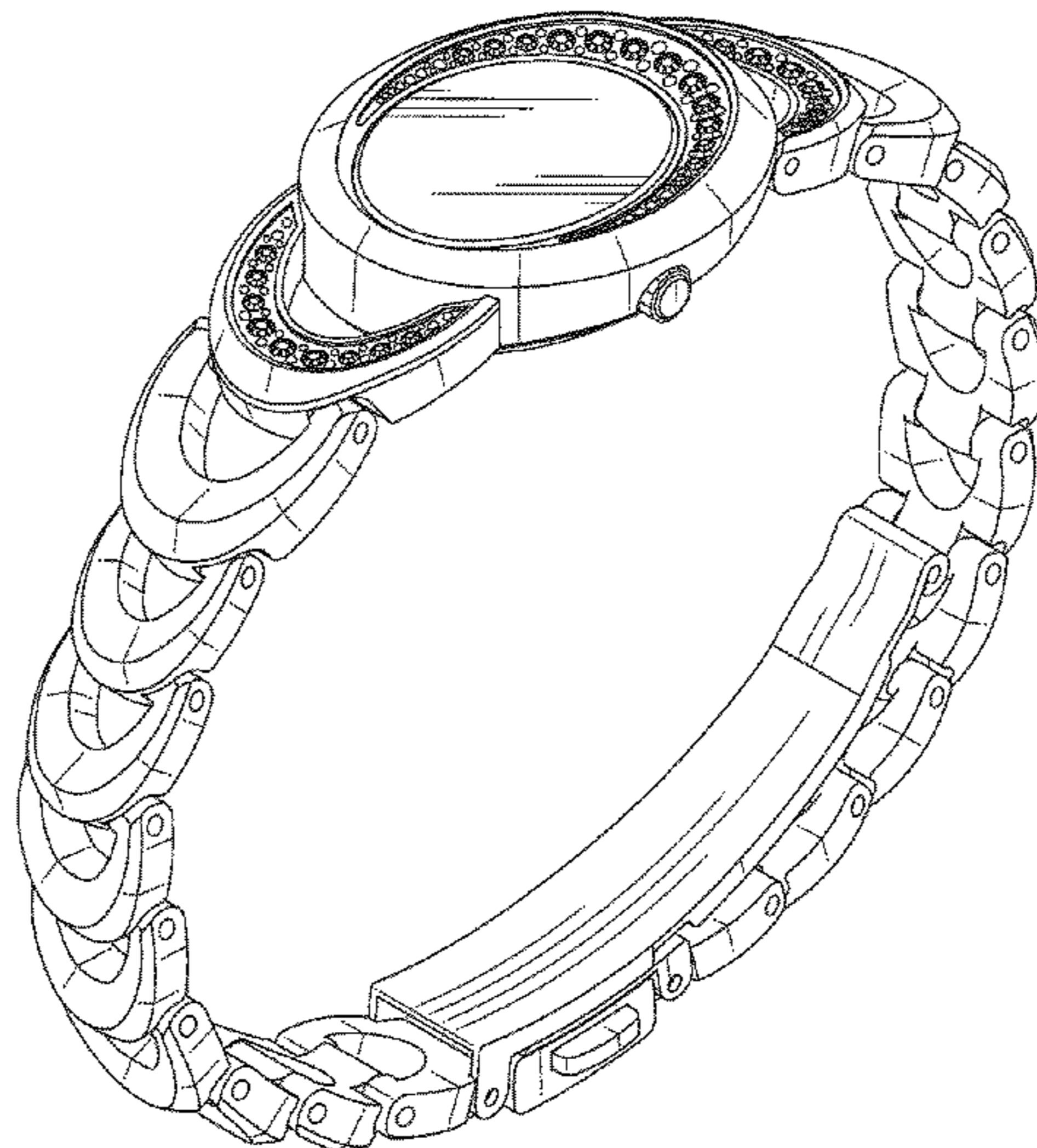

Fig. 1

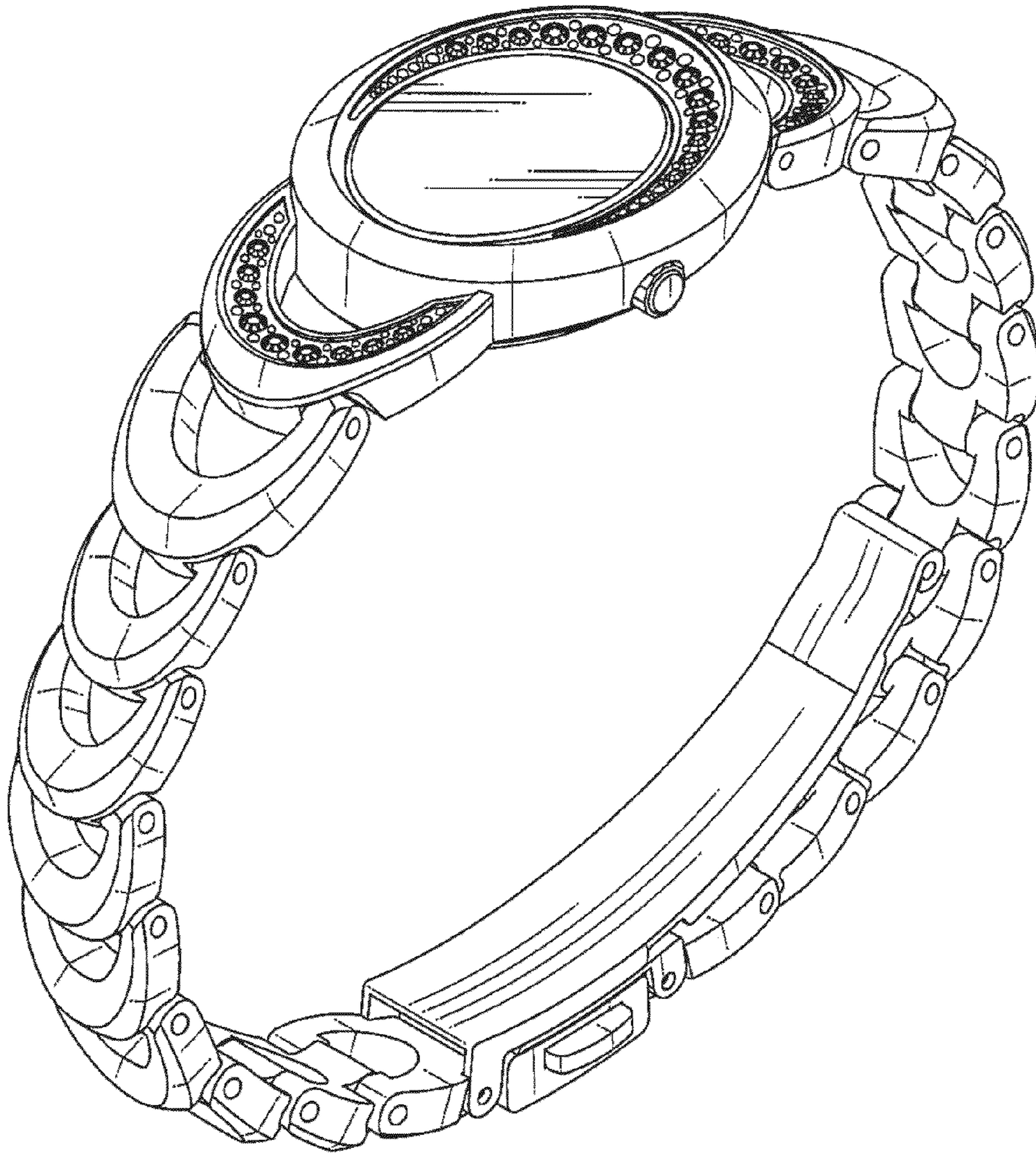

Fig. 2

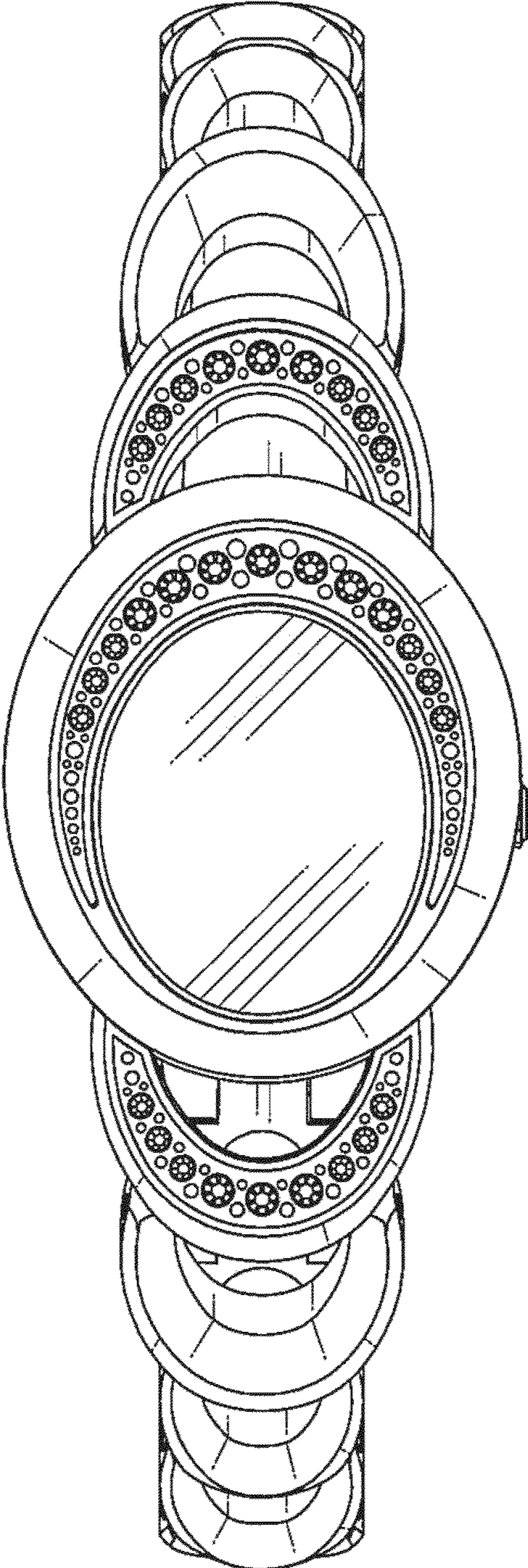

Fig. 3

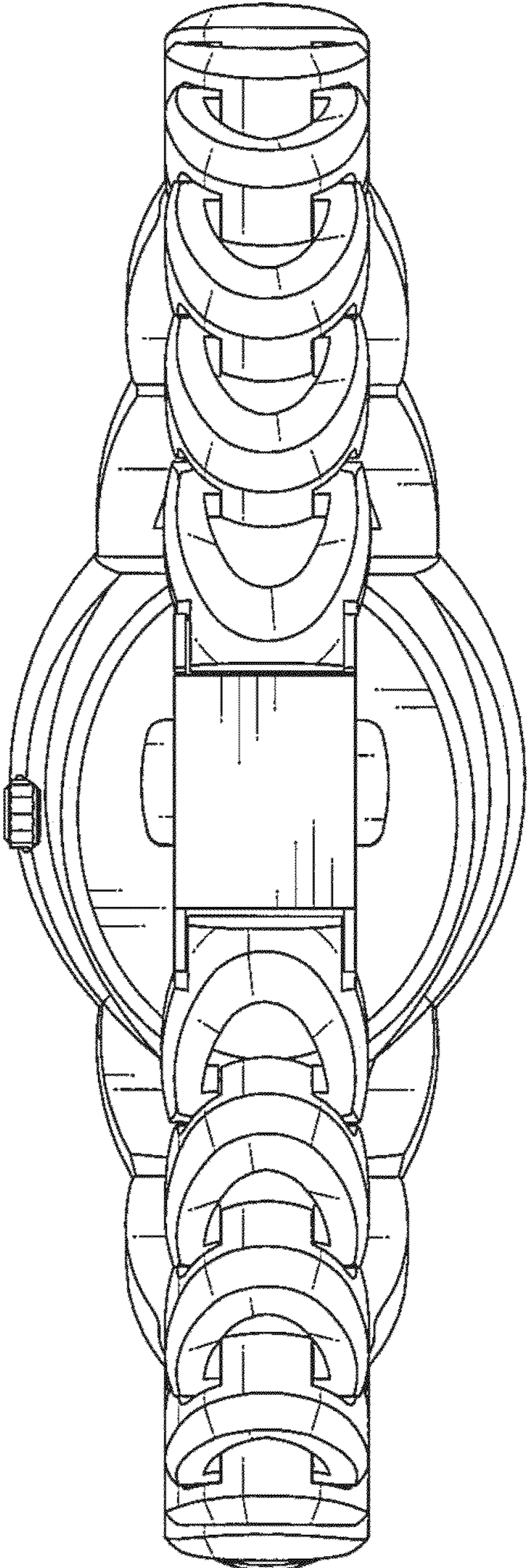

Fig. 4

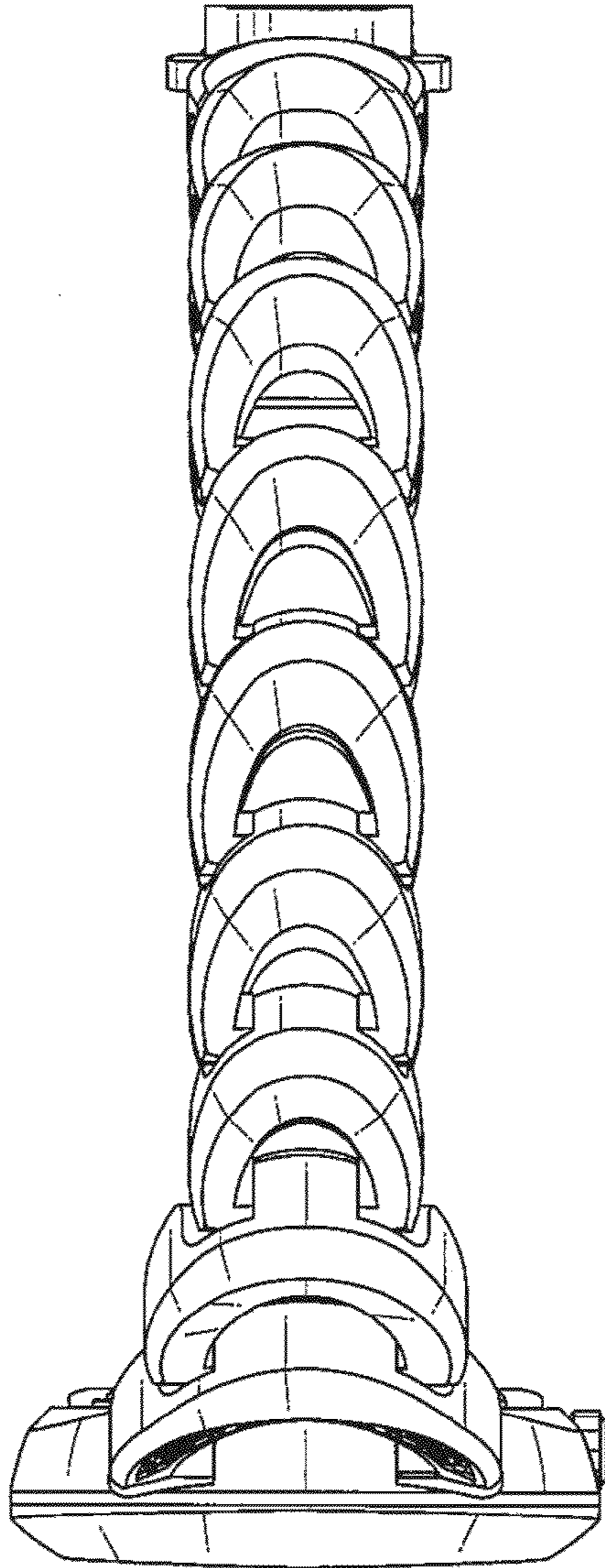

Fig. 5

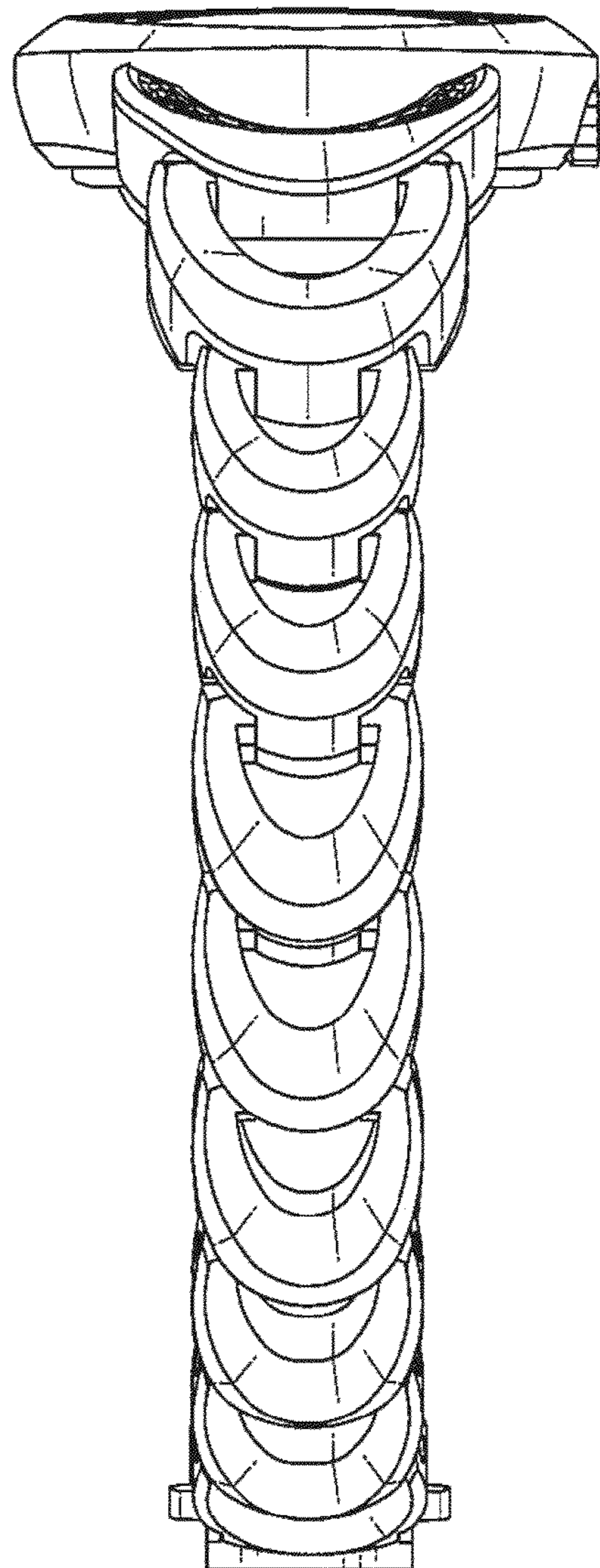

Fig. 6

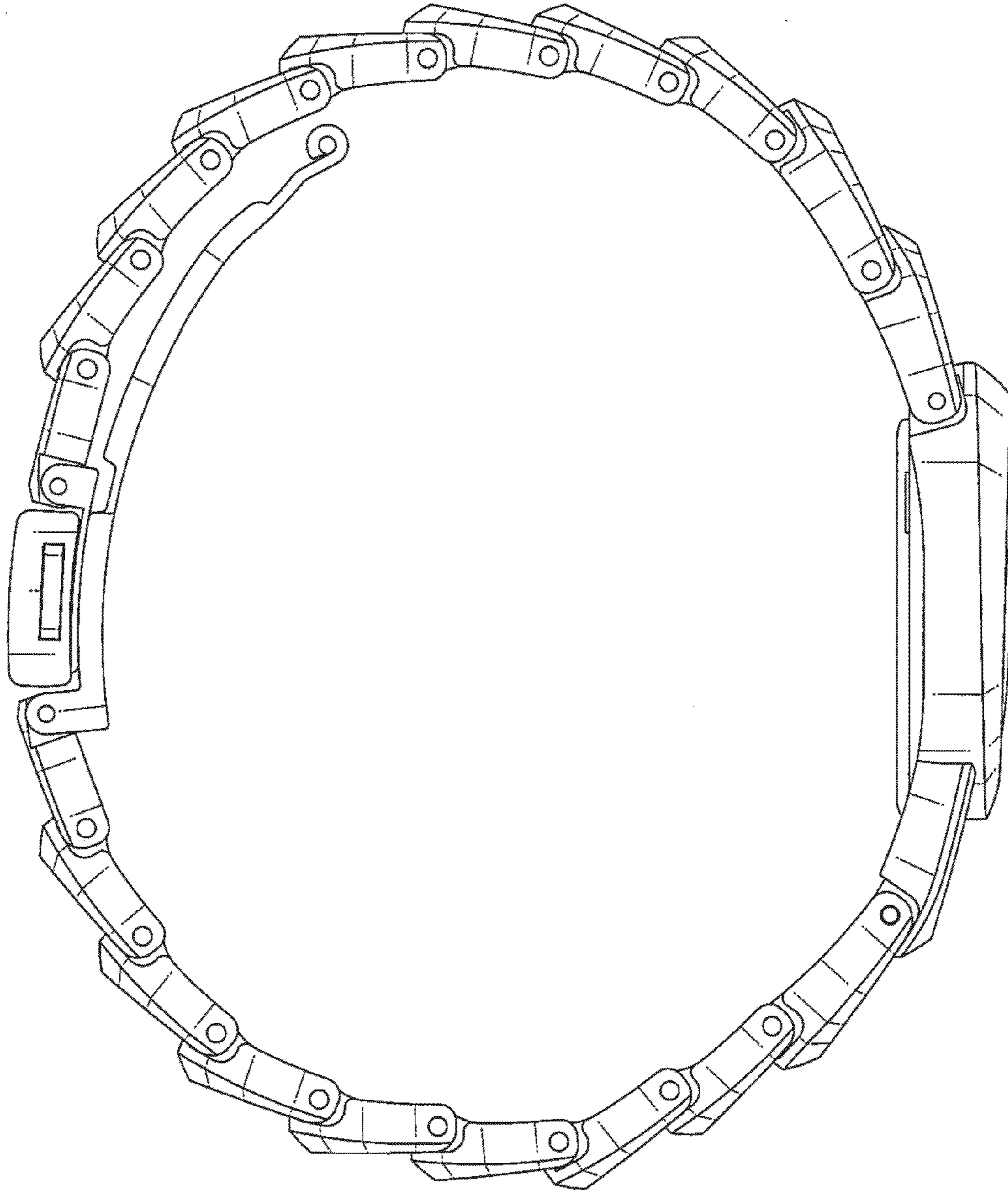

Fig. 7

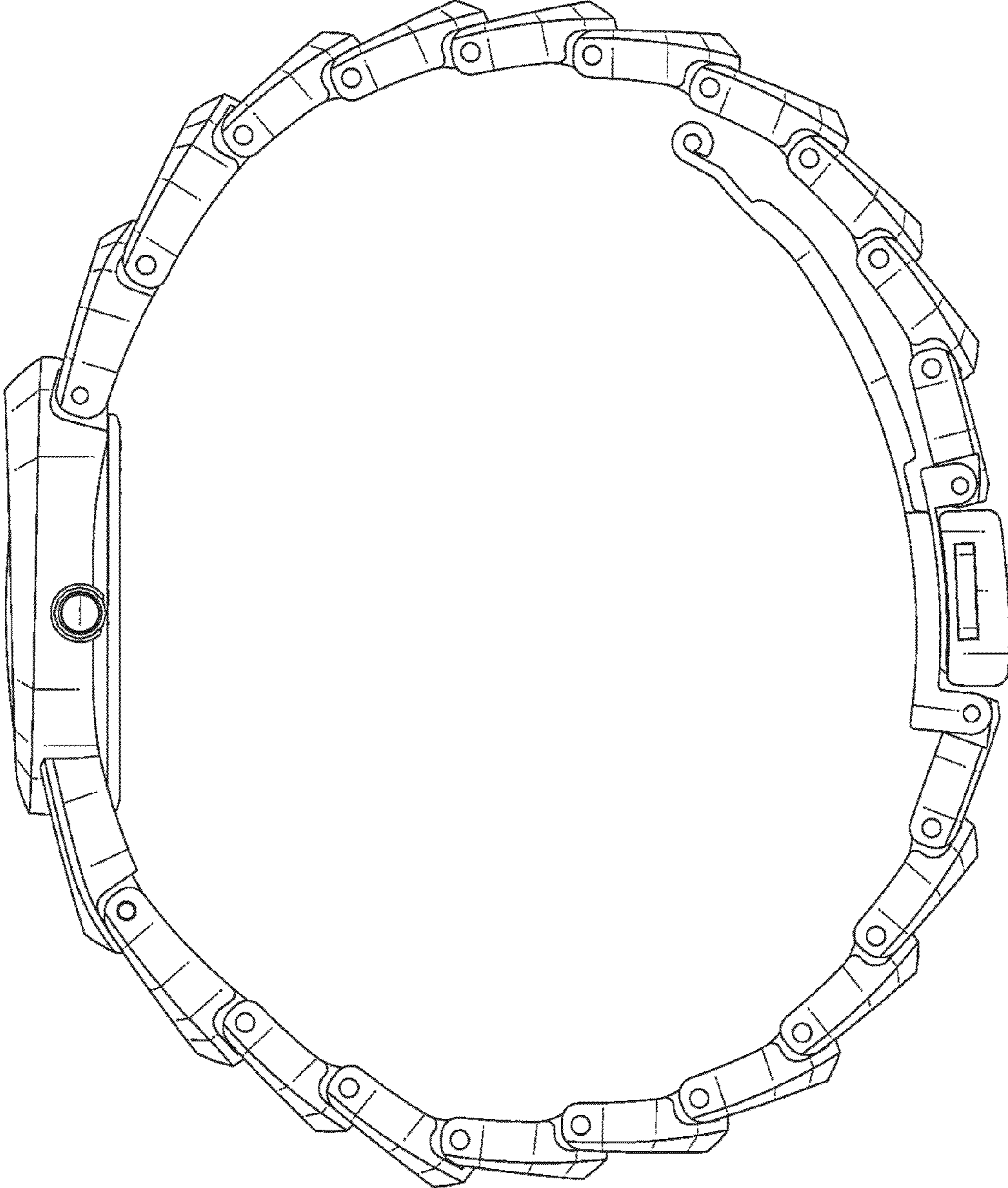

Fig. 8

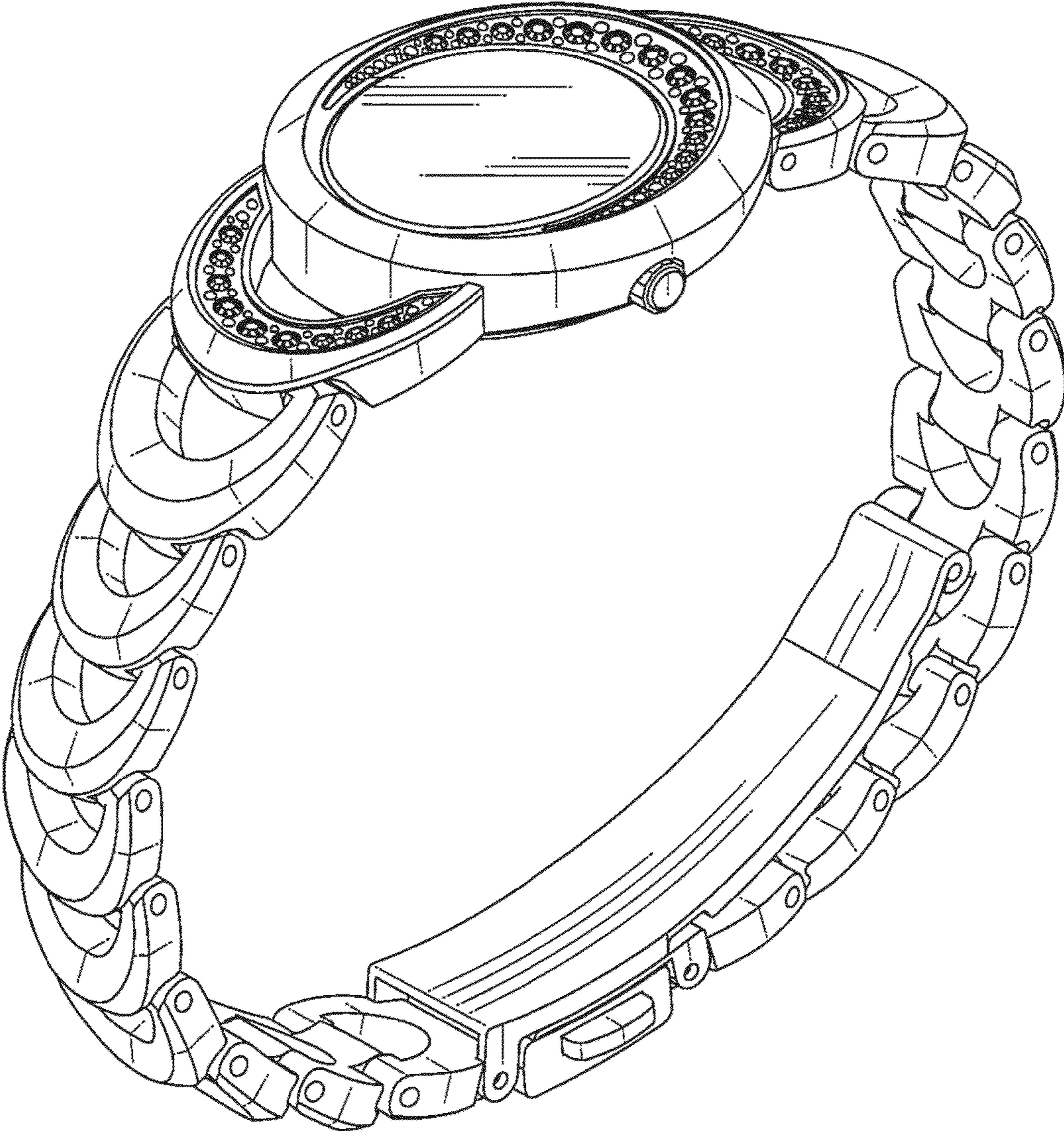

Fig. 9

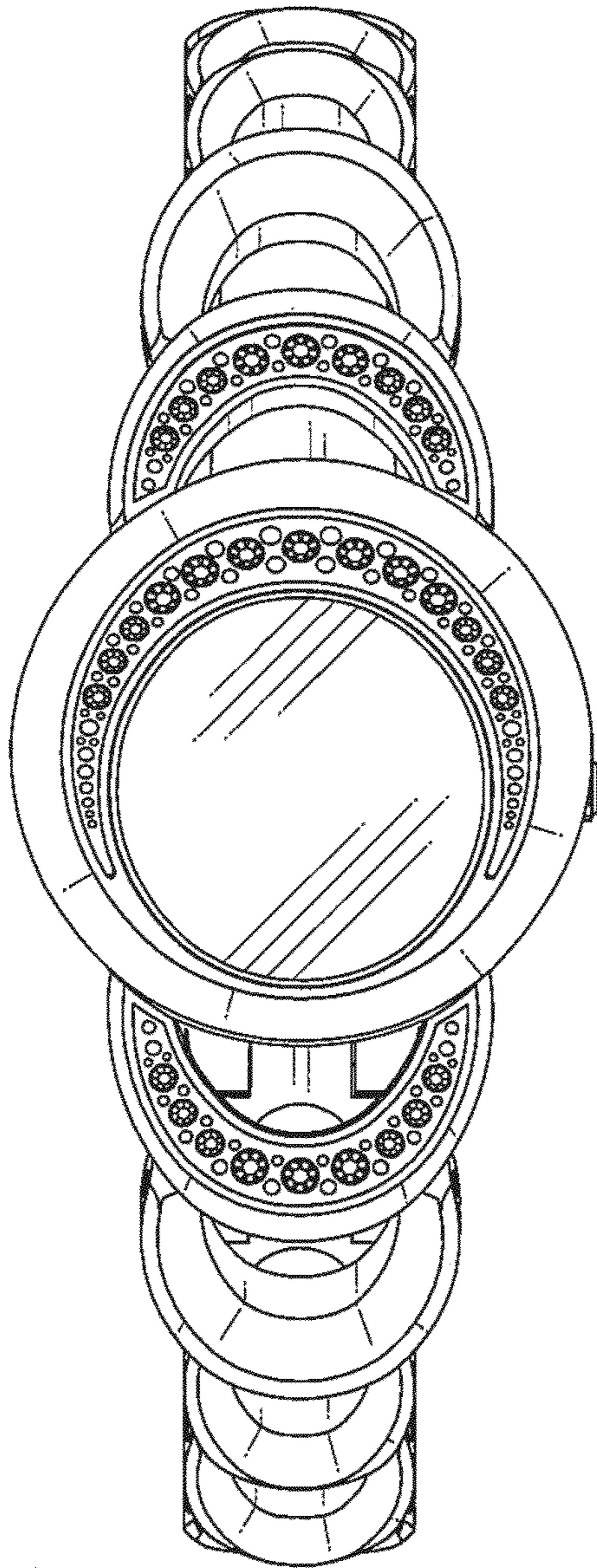

Fig. 10

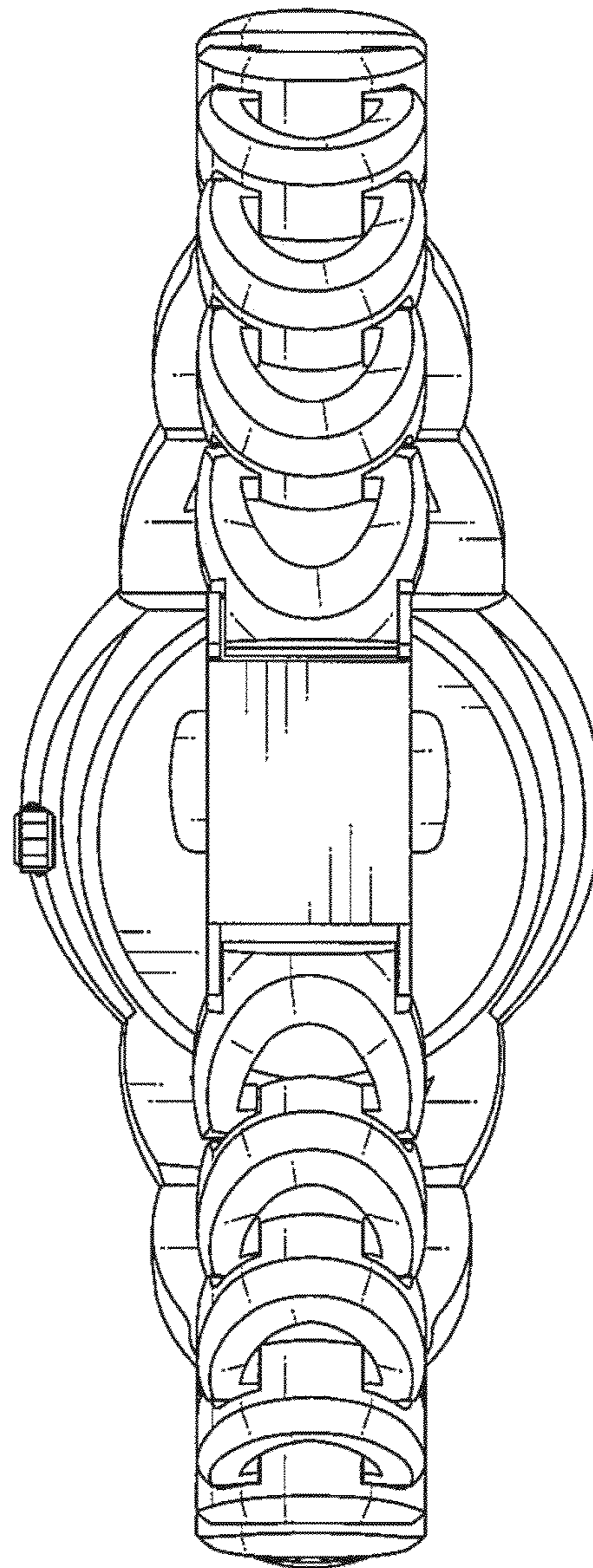

Fig. 11

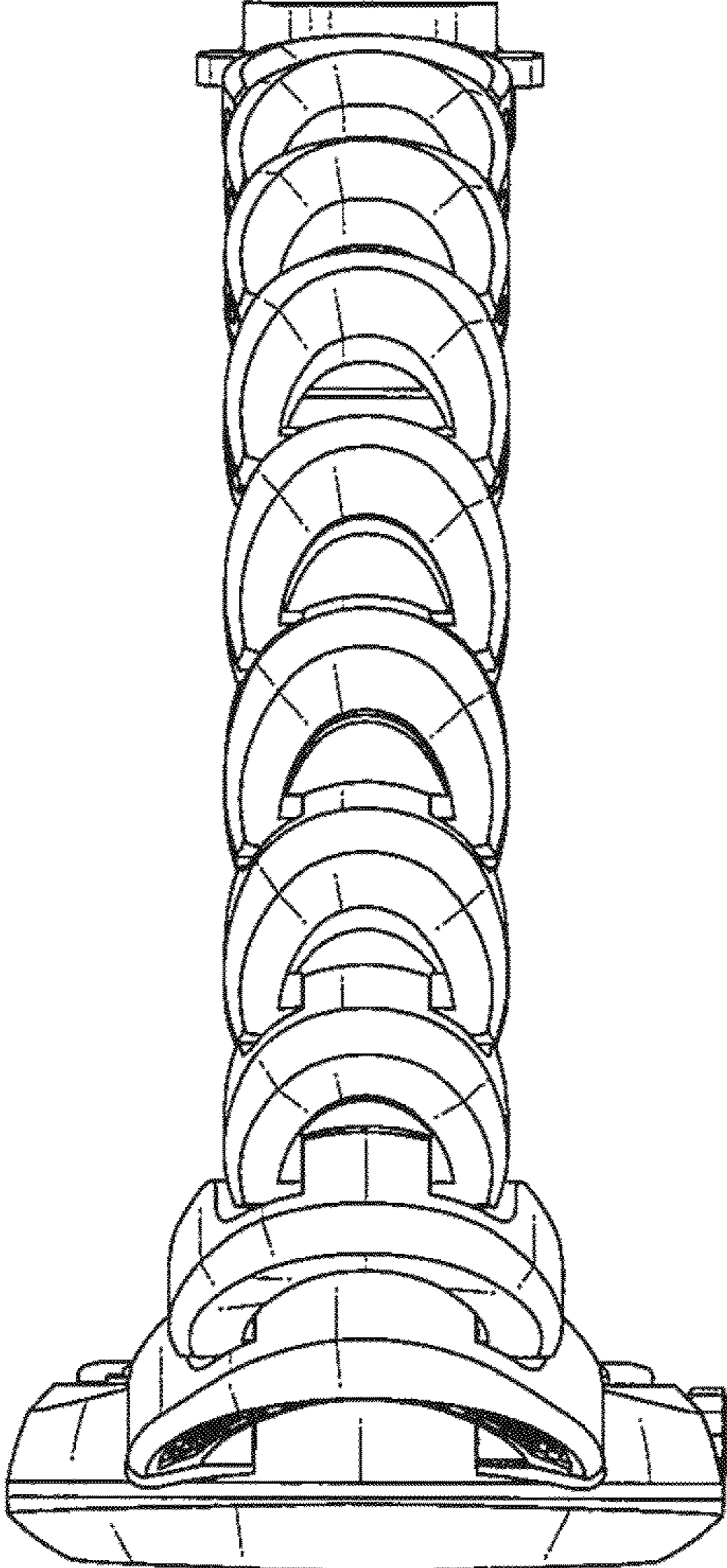

Fig. 12

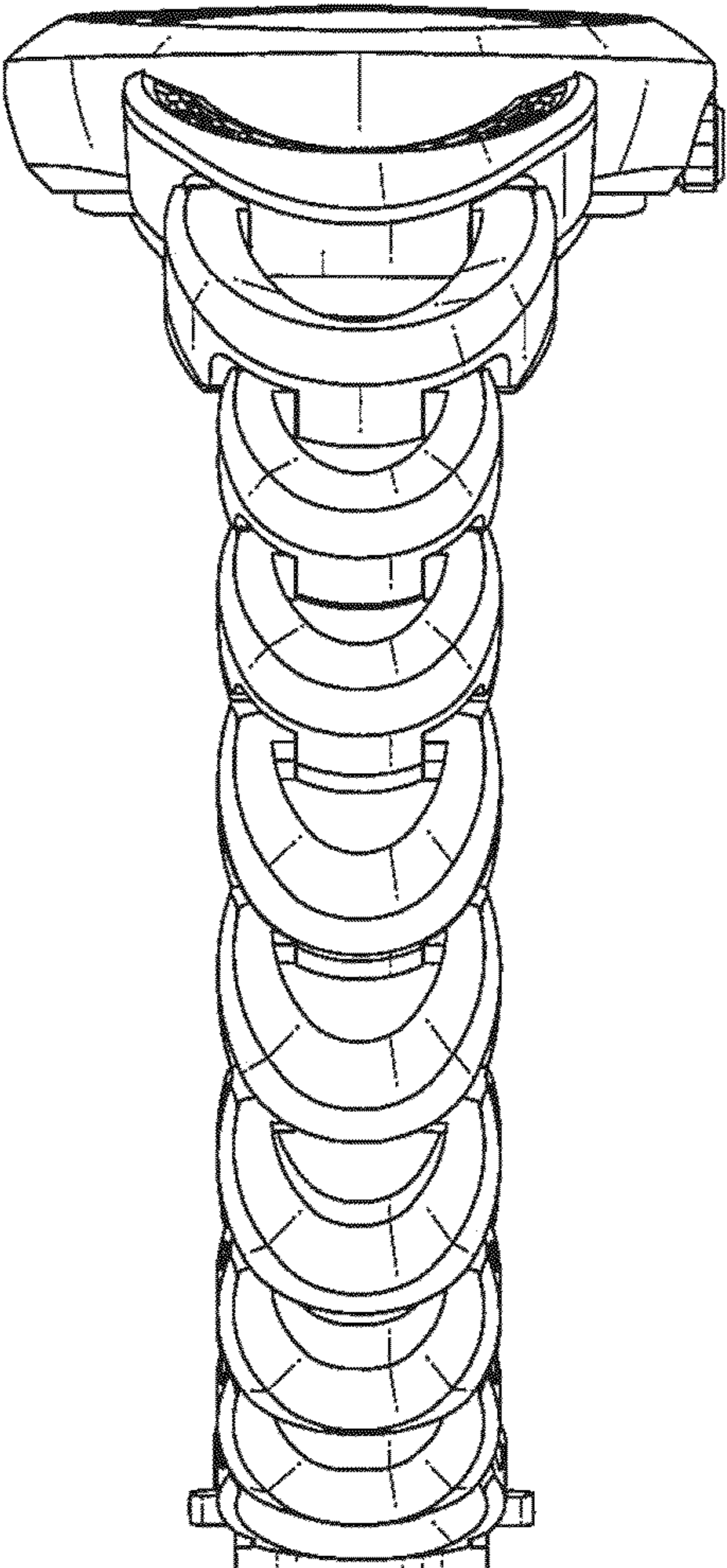

Fig. 13

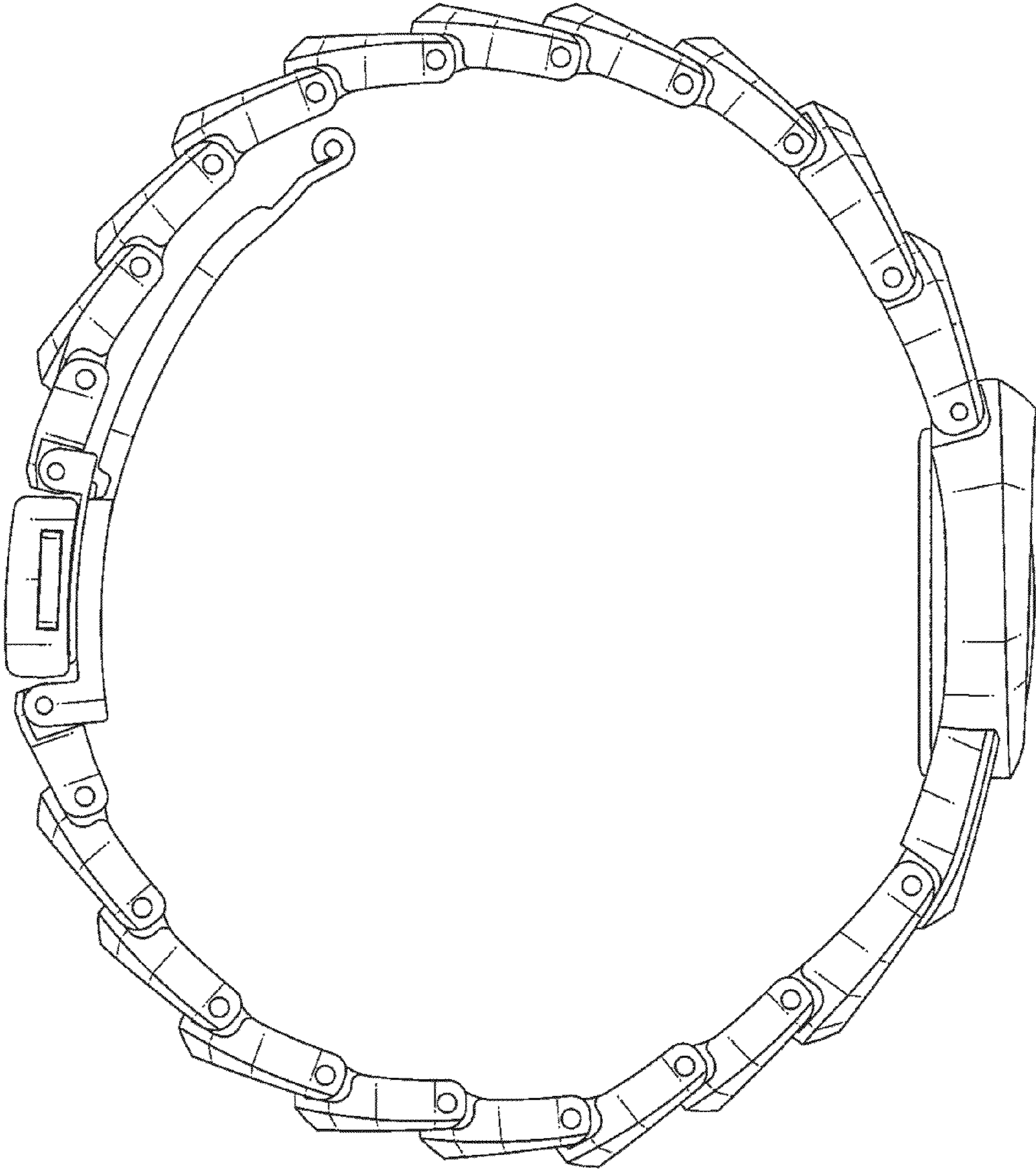

Fig. 14

