



US00D759483S

(12) **United States Design Patent**
Jalet

(10) **Patent No.:** **US D759,483 S**

(45) **Date of Patent:** **** Jun. 21, 2016**

(54) **SEAL FOR CONTAINER**

(71) Applicant: **Dart Industries Inc.**, Orlando, FL (US)

(72) Inventor: **Vincent Jalet**, Brussels (BE)

(73) Assignee: **Dart Industries Inc.**, Orlando, FL (US)

(**) Term: **15 Years**

(21) Appl. No.: **29/529,860**

(22) Filed: **Jun. 11, 2015**

(51) **LOC (10) Cl.** **09-07**

(52) **U.S. Cl.**
USPC **D9/443**

(58) **Field of Classification Search**
USPC D7/392.1, 602, 705; D9/434-440,
D9/443-445, 447, 449, 450, 452-454,
D9/499; 220/260
CPC A21B 3/135; A21B 3/138
See application file for complete search history.

(56) **References Cited**

U.S. PATENT DOCUMENTS

- 5,065,889 A * 11/1991 Conti A47G 19/027
220/360
- D383,939 S * 9/1997 Jeppesen D7/391
- D415,385 S * 10/1999 Loew D7/392.1
- D445,687 S * 7/2001 Gilbertson D7/392.1
- D564,356 S * 3/2008 Nickleberry D9/454
- D612,196 S * 3/2010 Furlong D7/392.1
- D621,667 S 8/2010 Ablo
- D641,209 S 7/2011 Ablo
- D652,672 S 1/2012 Easton
- D676,276 S 2/2013 Muspratt-Williams
- D676,745 S * 2/2013 MacNeill D9/443
- D708,470 S * 7/2014 Heiberg D7/354

- D722,814 S * 2/2015 Heiberg D7/354
- D731,241 S * 6/2015 Yessin D7/392.1
- D742,743 S * 11/2015 Thurin D9/443

* cited by examiner

Primary Examiner — Robert M Spear

Assistant Examiner — Darcey E Heflin

(74) *Attorney, Agent, or Firm* — Taylor J. Ross

(57) **CLAIM**

The ornamental design for a seal for container, as shown and described.

DESCRIPTION

FIG. 1 is a top, front and right side perspective view of a first embodiment of a seal for container showing my new design; FIG. 2 is a top plan view thereof; FIG. 3 is a bottom plan view thereof; FIG. 4 is a right side elevation view, the left side being a mirror image thereof; FIG. 5 is a front elevation view thereof; FIG. 6 is a rear elevation view thereof; FIG. 7 is a cross-sectional view taken in the direction of line 7-7 of FIG. 3; FIG. 8 is a top, front and right side perspective view of a second embodiment of a seal for container showing my new design; FIG. 9 is a top plan view thereof; FIG. 10 is a bottom plan view thereof; FIG. 11 is a right side elevation view, the left side being a mirror image thereof; FIG. 12 is a front elevation view thereof; FIG. 13 is a rear elevation view thereof; and, FIG. 14 is a cross-sectional view taken in the direction of line 14-14 of FIG. 9.

1 Claim, 6 Drawing Sheets

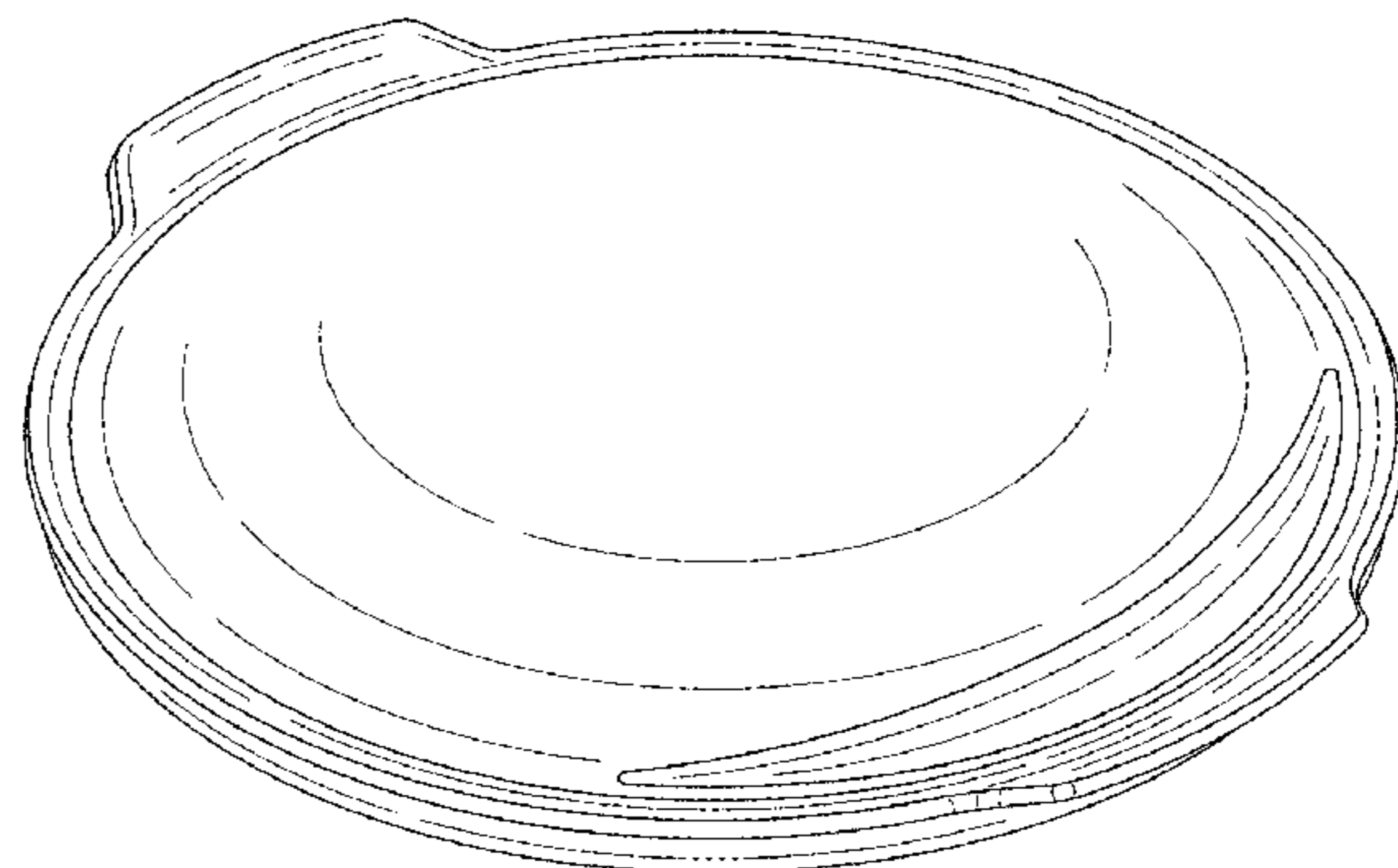
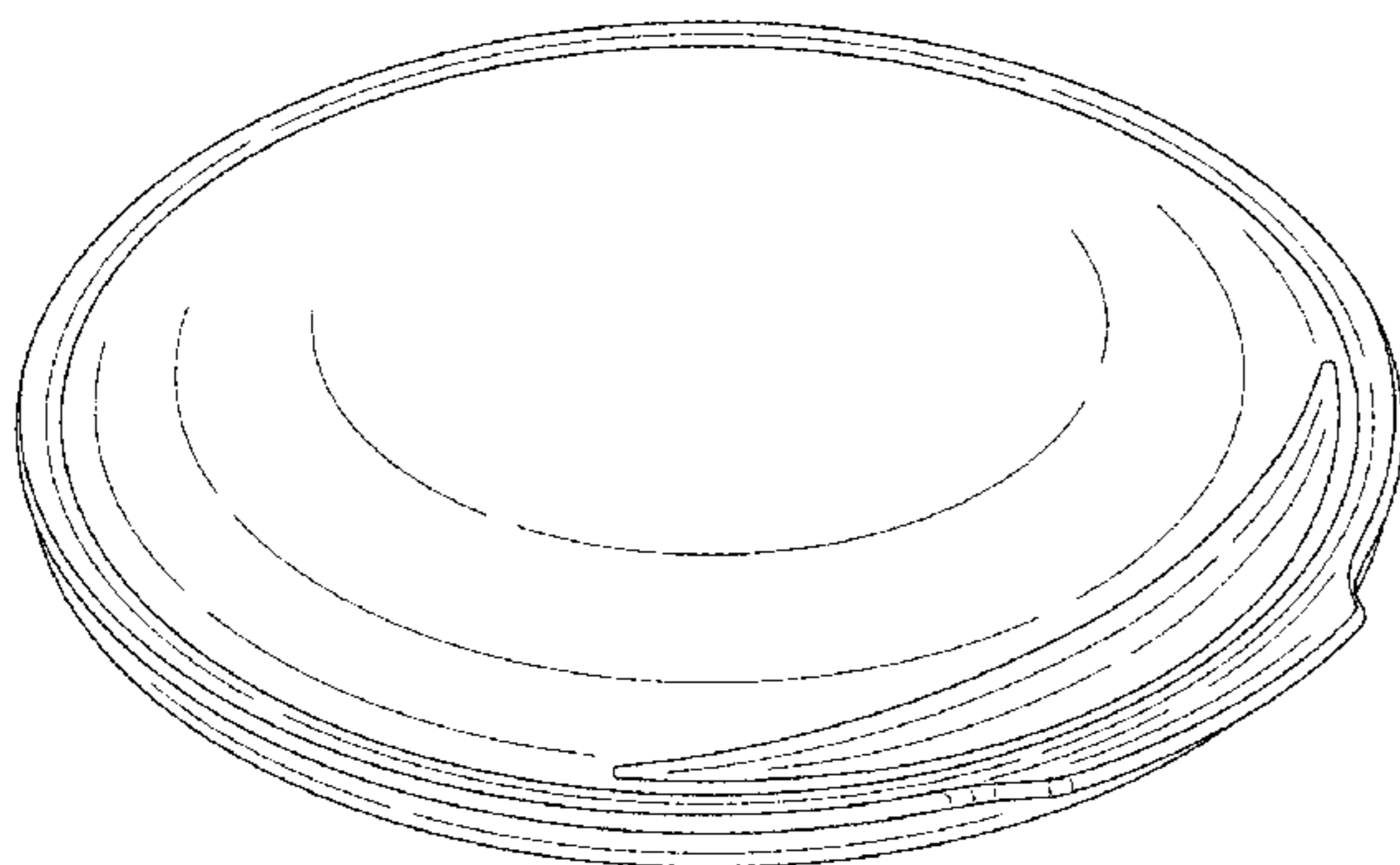

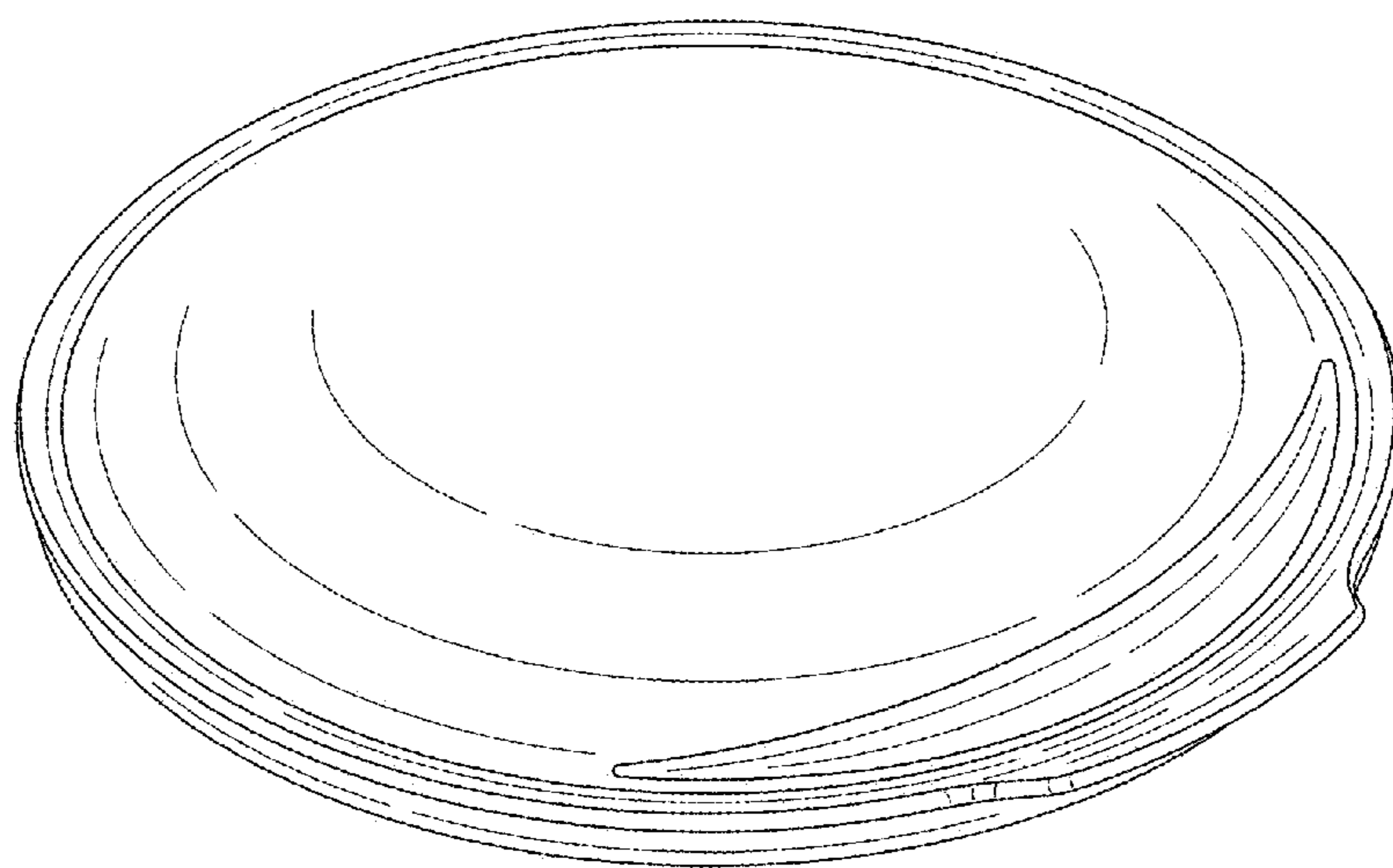

FIG. 1

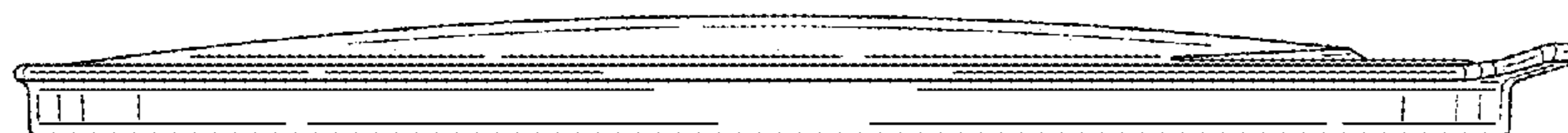

FIG. 4

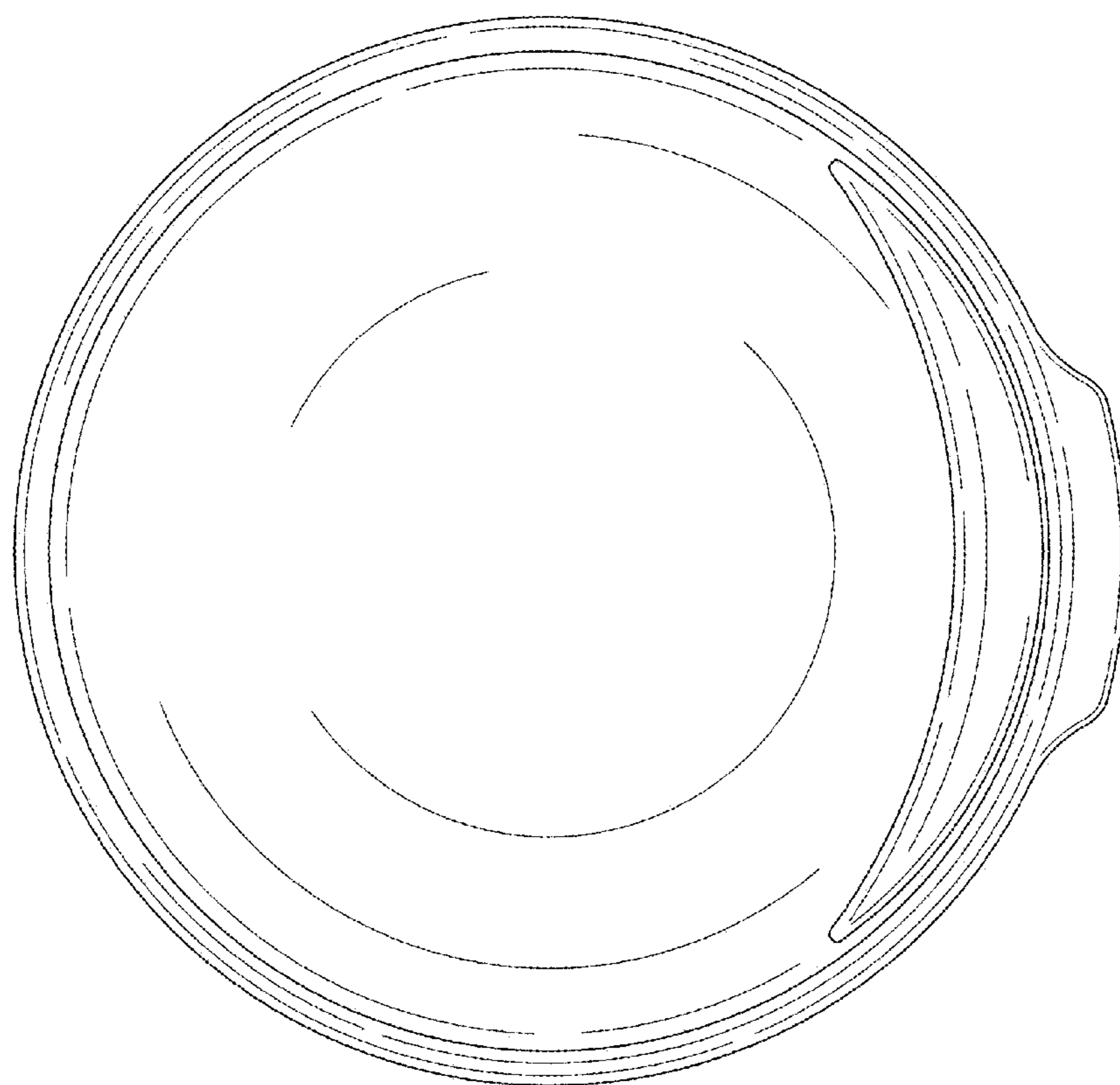

FIG. 2

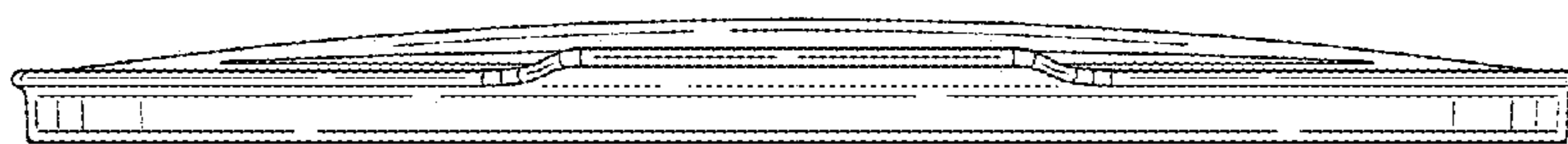

FIG. 5

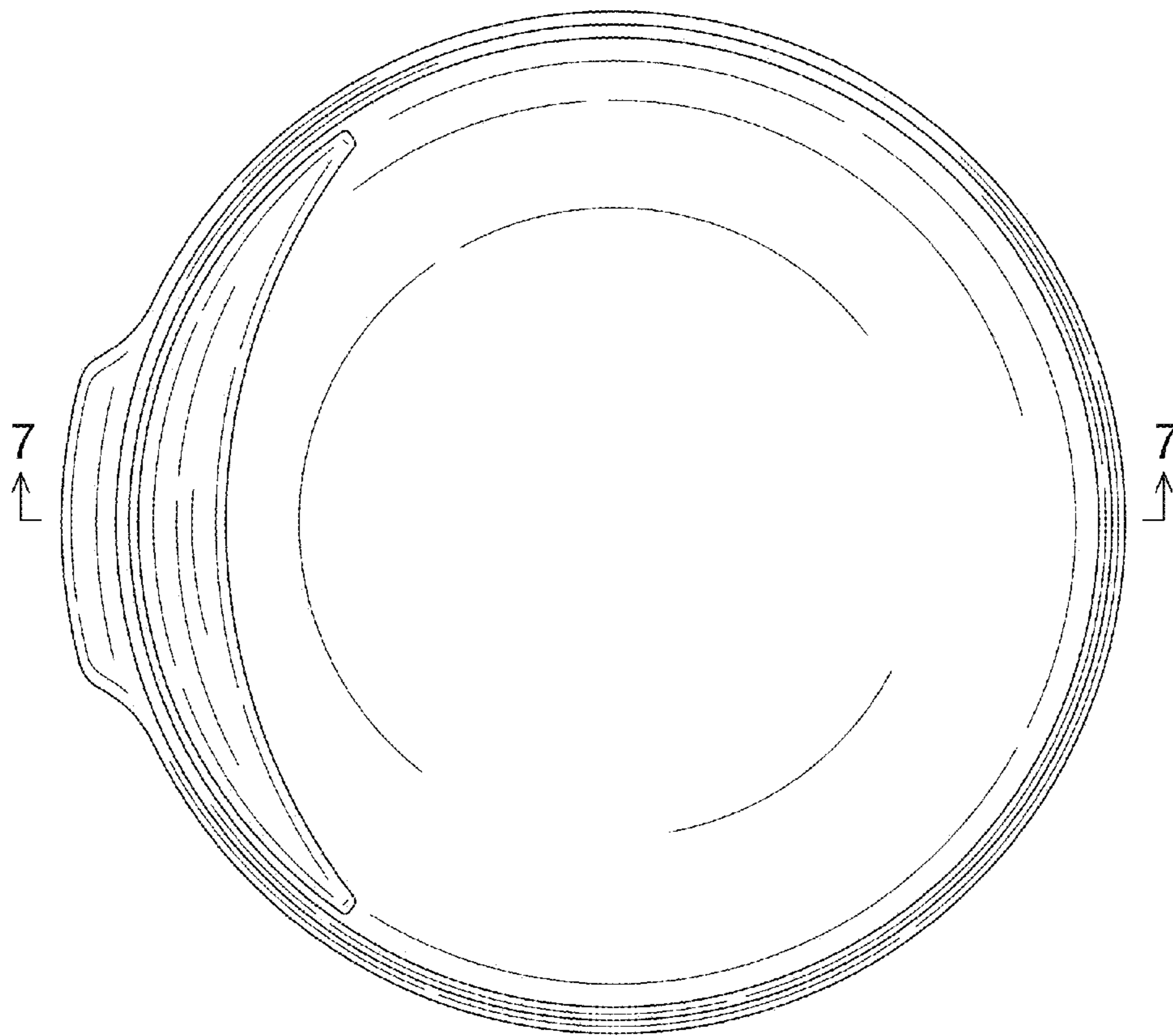

FIG. 3

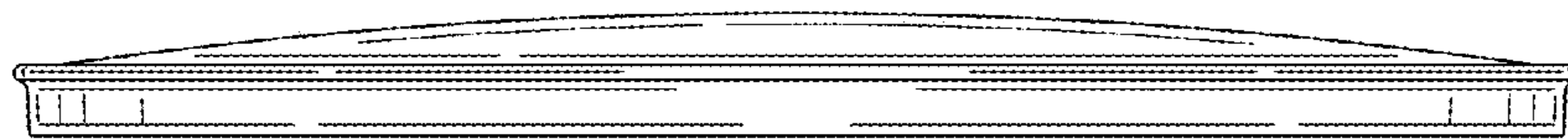

FIG. 6

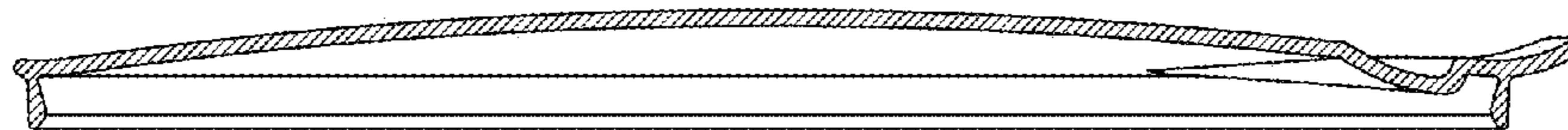

FIG. 7

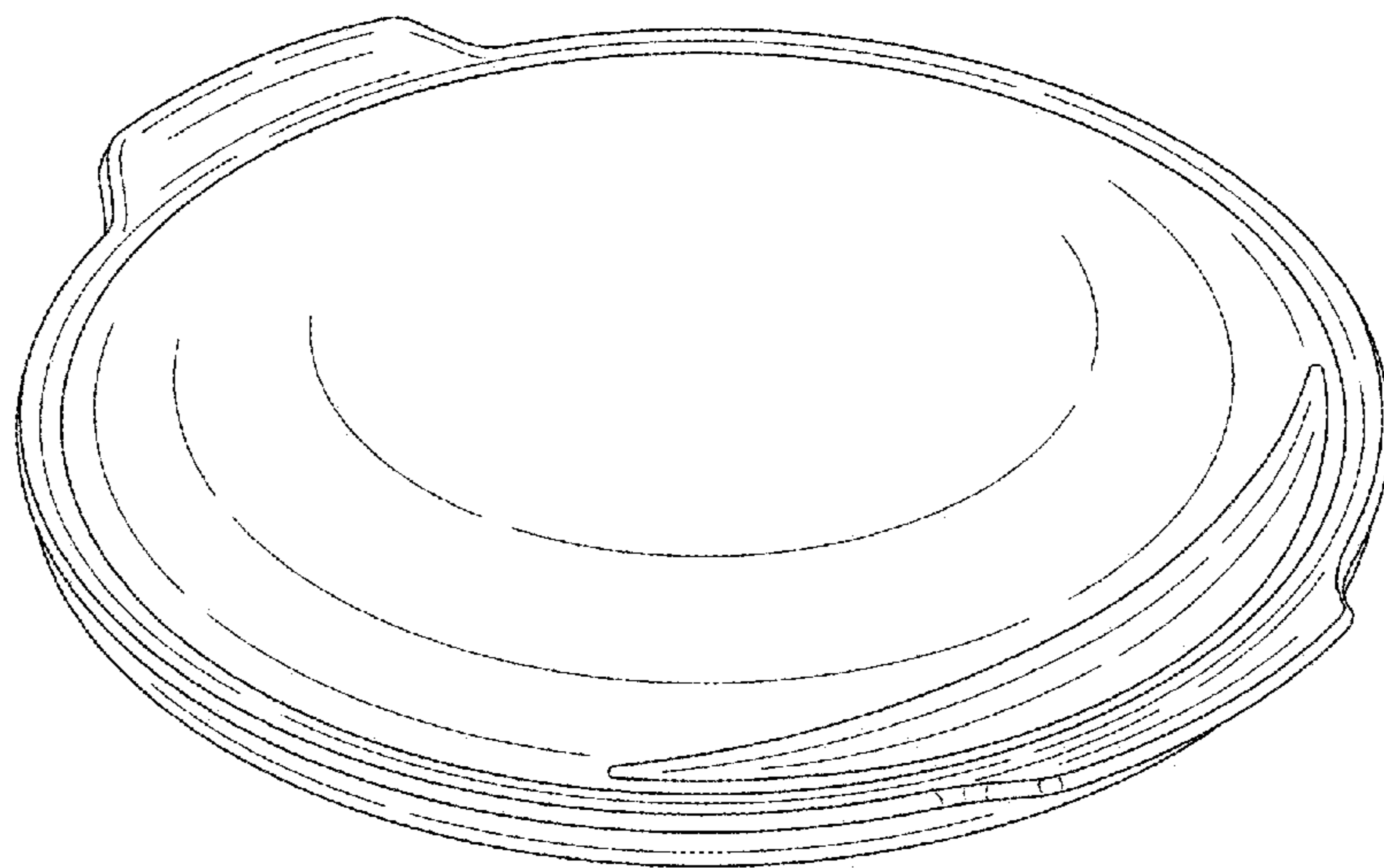

FIG. 8

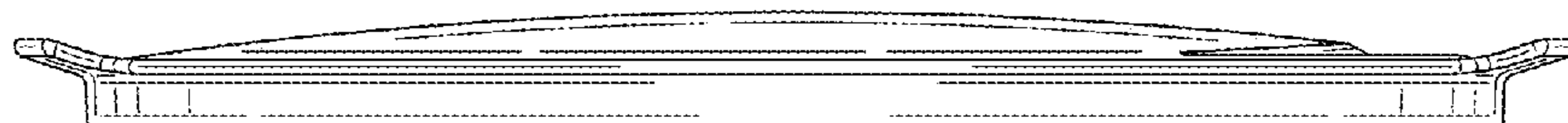

FIG. 11

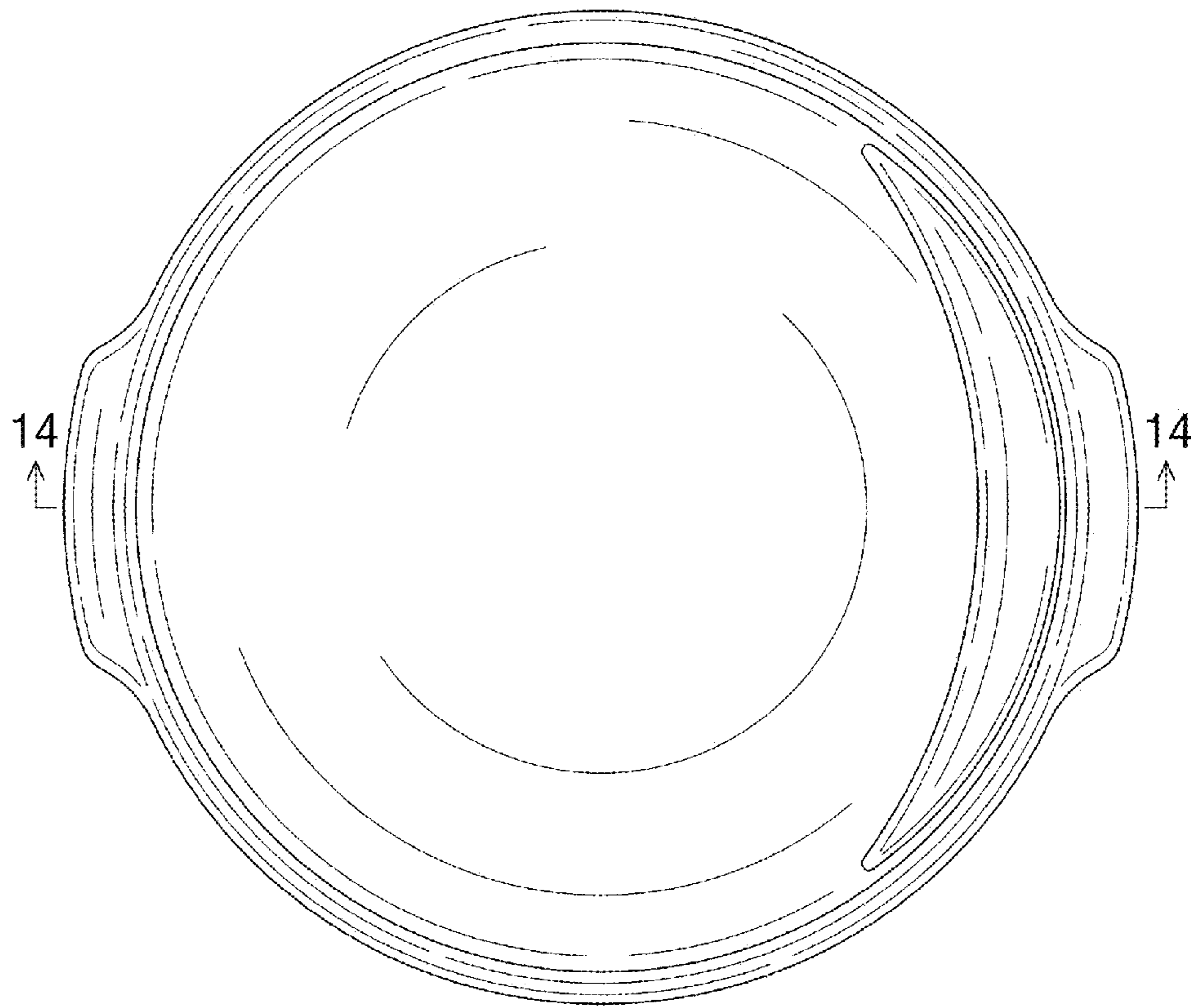

FIG. 9



FIG. 12

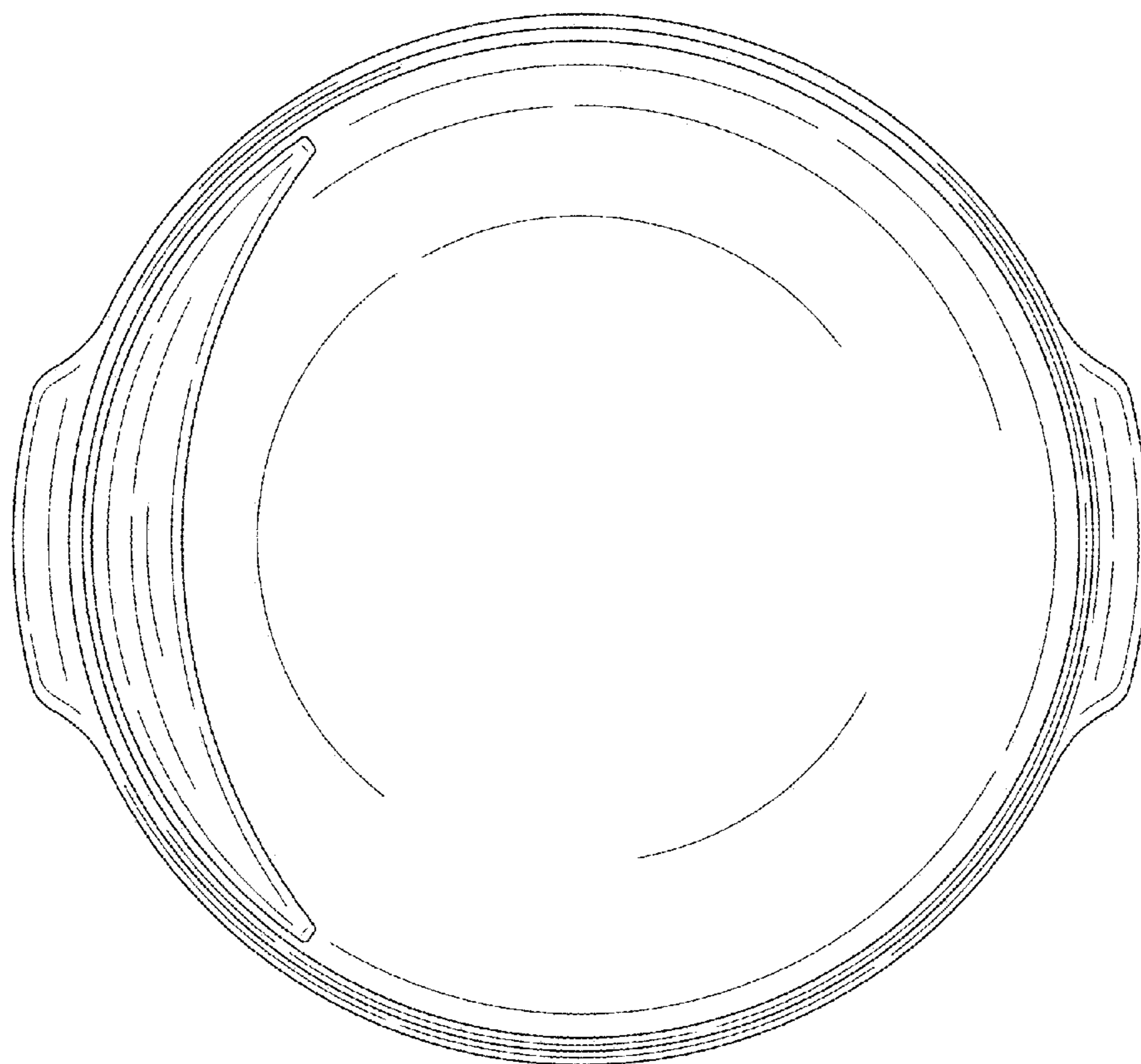

FIG. 10

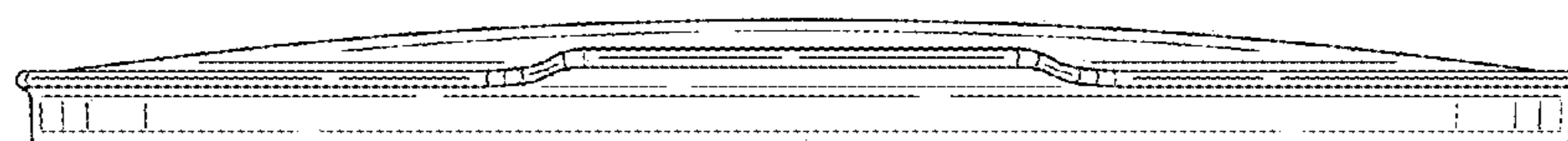

FIG. 13

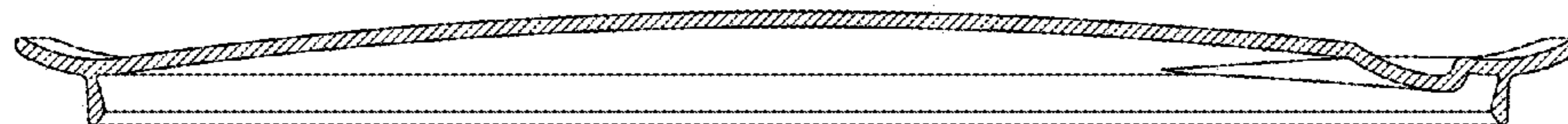

FIG. 14