



US00D759452S

(12) **United States Design Patent**
Persson et al.

(10) **Patent No.:** **US D759,452 S**
(45) **Date of Patent:** **** Jun. 21, 2016**

(54) **HAND OPERATED CRIMPING TOOL**

(71) Applicant: **Pressmaster AB, Älvdalen (SE)**
(72) Inventors: **Lars-Olov Persson, Älvdalen (SE);
Daniel Ullbors, Mora (SE)**
(73) Assignee: **Pressmaster AB, Älvdalen (SE)**
(**) Term: **14 Years**

(21) Appl. No.: **29/507,617**

(22) Filed: **Oct. 29, 2014**

(30) **Foreign Application Priority Data**

Jul. 11, 2014 (EM) 002501338-0001

(51) **LOC (10) Cl.** **08-05**

(52) **U.S. Cl.**
USPC **D8/52**

(58) **Field of Classification Search**
USPC D8/4, 5, 51-56
CPC Y10T 29/53226; Y10T 29/5151;
Y10T 29/583235; Y10T 29/53643; H01R
43/042; H01R 43/0421; H01R 43/05

See application file for complete search history.

(56) **References Cited**

U.S. PATENT DOCUMENTS

6,612,147	B2 *	9/2003	Beetz	B25B 7/12 7/128
7,000,322	B2 *	2/2006	Murphy	H02G 1/1236 30/357
D544,323	S *	6/2007	Hutchfield	D8/52
8,296,956	B2 *	10/2012	Battenfeld	H02G 1/1221 30/90.1
D693,197	S *	11/2013	Hutchfield	D8/51
D693,198	S *	11/2013	Hutchfield	D8/51
D740,095	S *	10/2015	Battenfeld	D8/52

* cited by examiner

Primary Examiner — Deanna L Pratt

(74) *Attorney, Agent, or Firm* — Studebaker & Brackett PC

(57) **CLAIM**

The ornamental design for a hand operated crimping tool, as shown and described.

DESCRIPTION

FIG. 1 is a perspective view showing our new design for a hand operated crimping tool, FIG. 2 is another perspective view thereof, FIG. 3 is another perspective view thereof, FIG. 4 is another perspective view thereof, FIG. 5 is a front view thereof, FIG. 6 is a rear view thereof, FIG. 7 is a left side view thereof, FIG. 8 is a right side view thereof, FIG. 9 is a top view thereof; and, FIG. 10 is a bottom thereof.

1 Claim, 10 Drawing Sheets

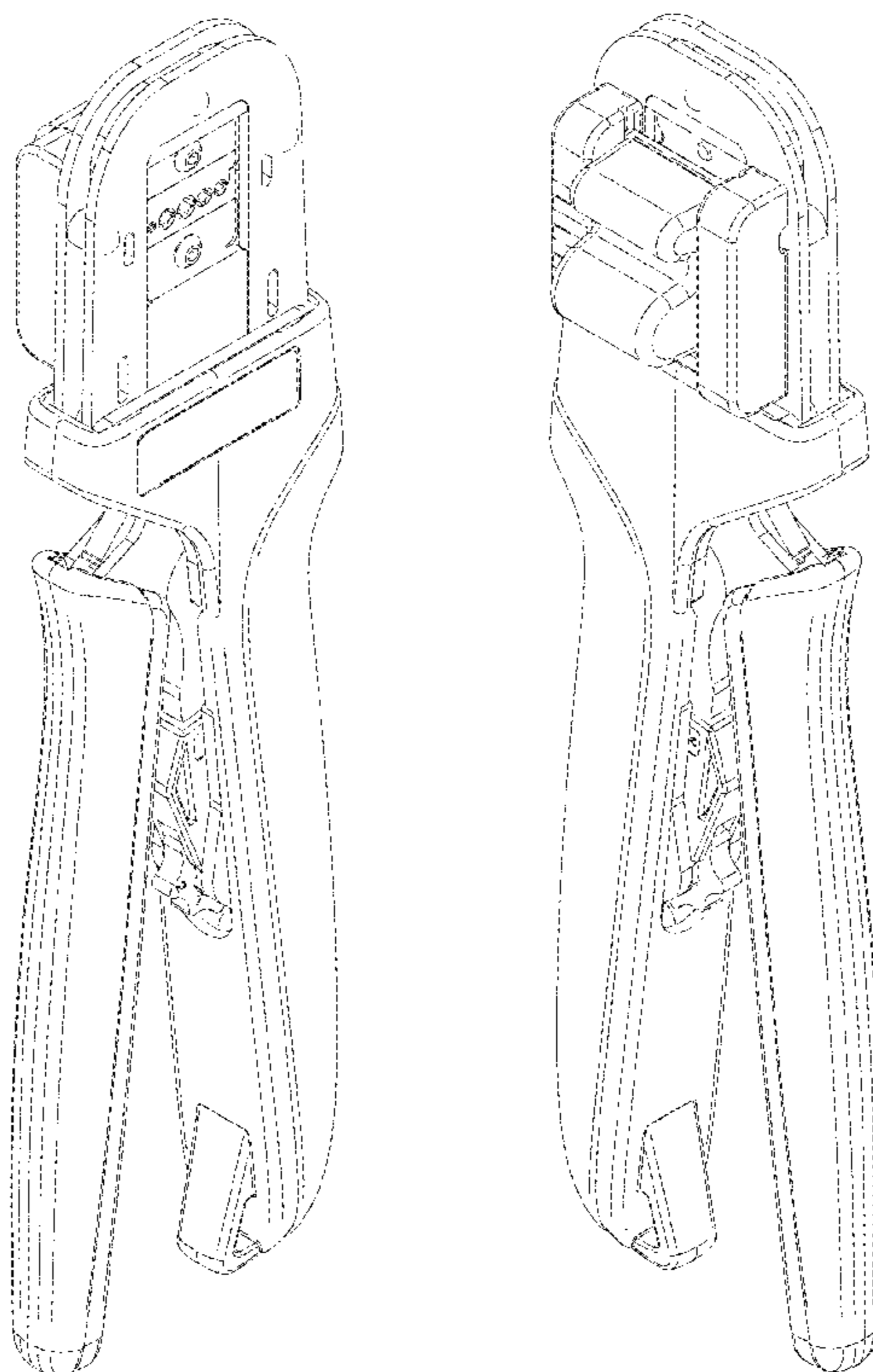

FIG. 1

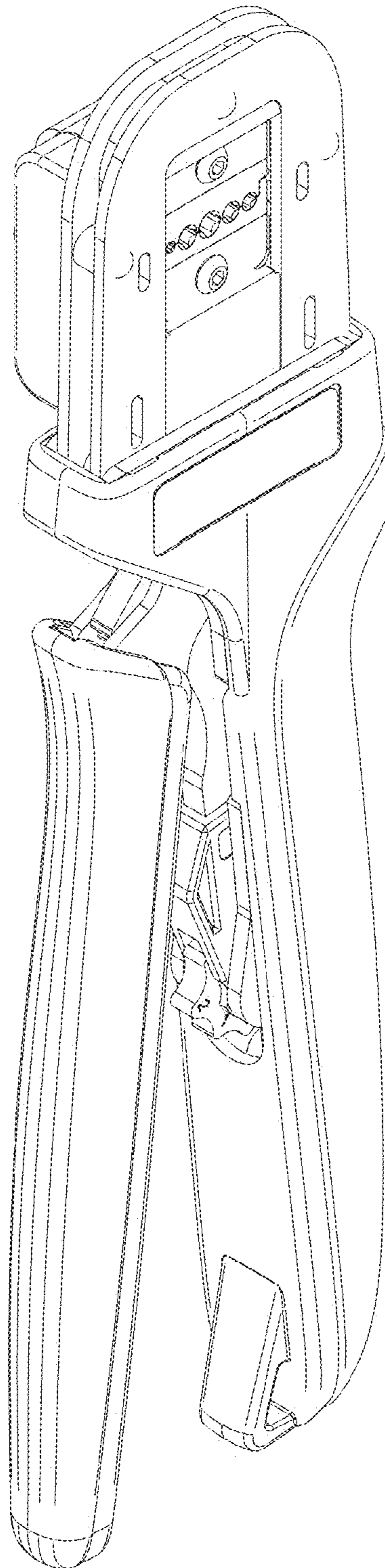

FIG. 2

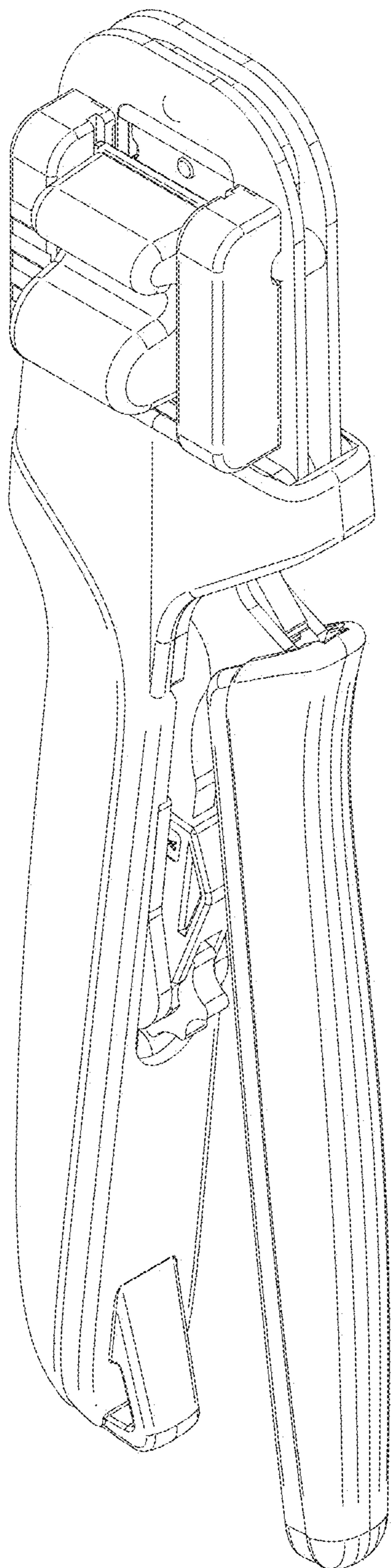

FIG. 3

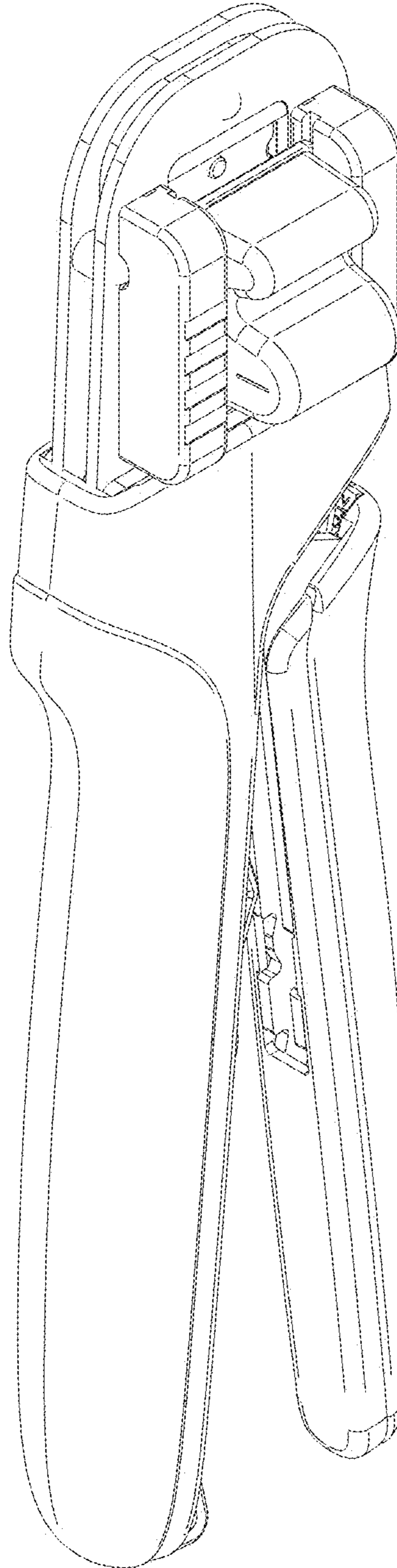
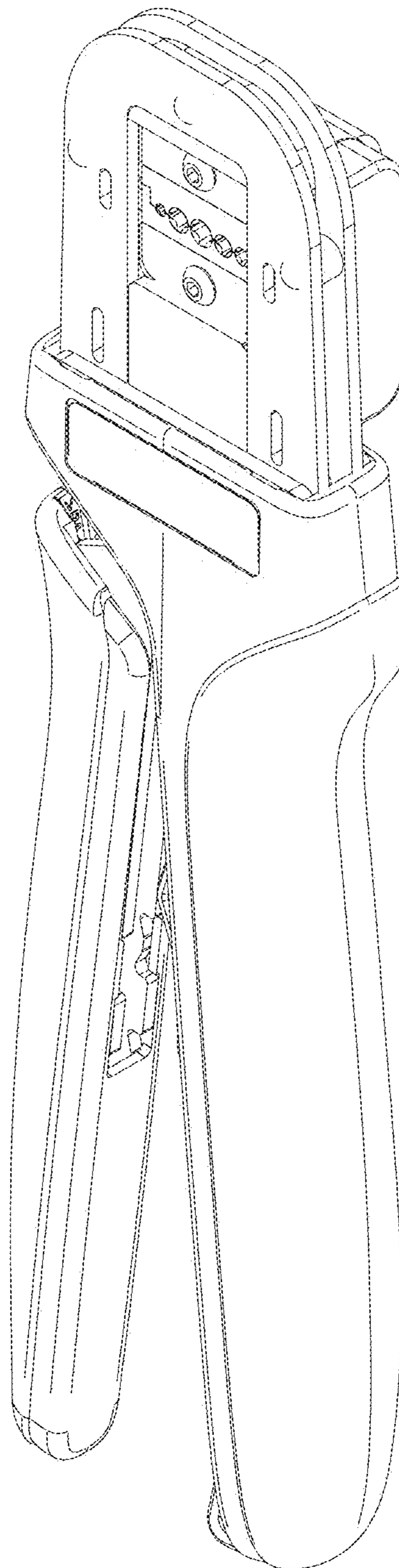

FIG. 4



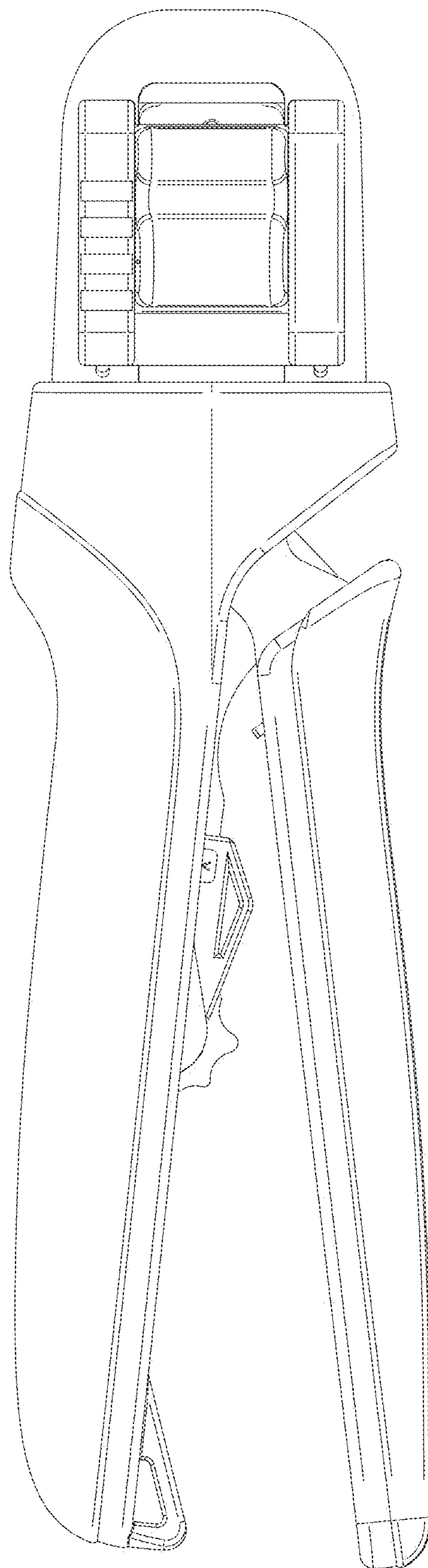

FIG. 5

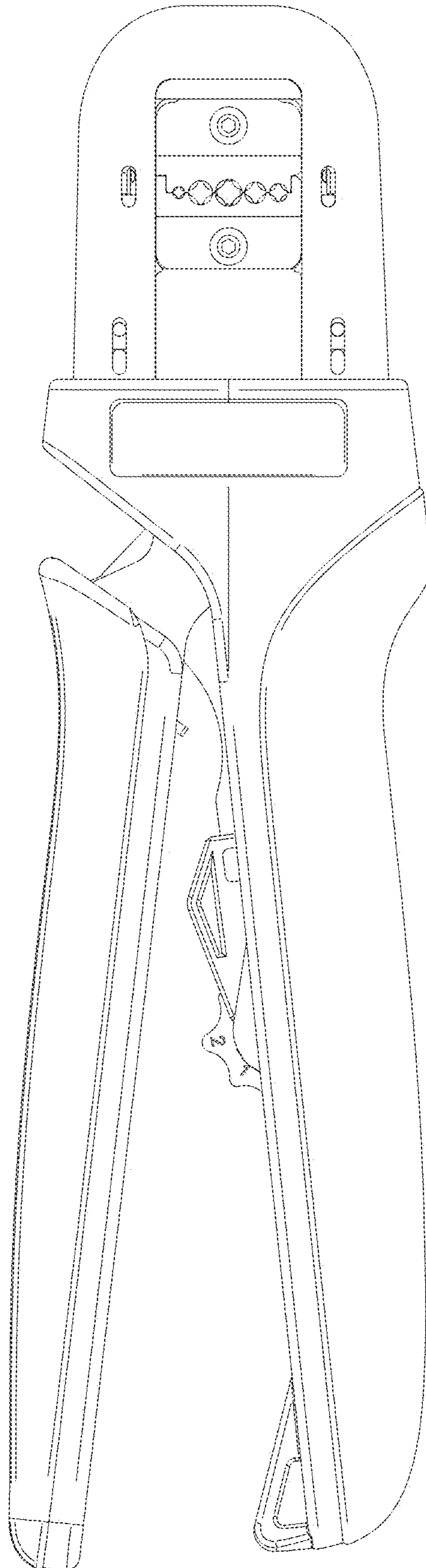
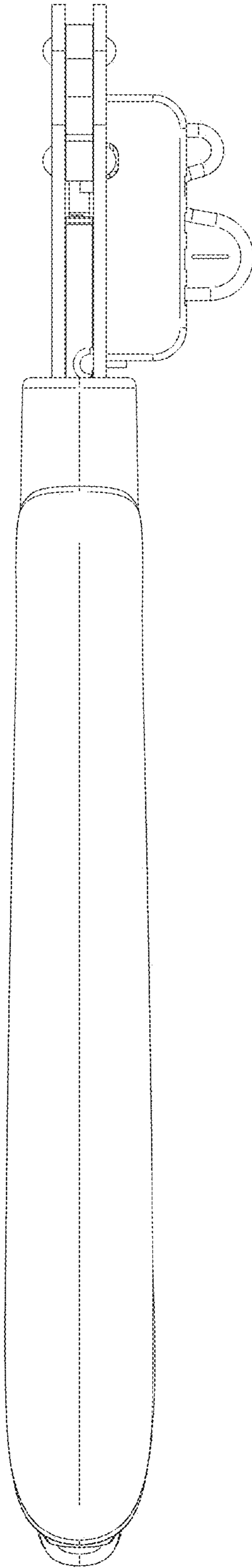

FIG. 6

FIG. 7



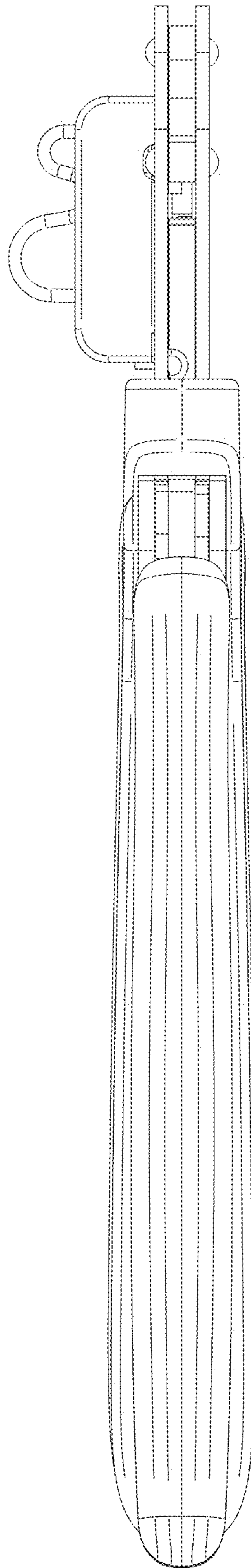

FIG. 8

FIG. 9

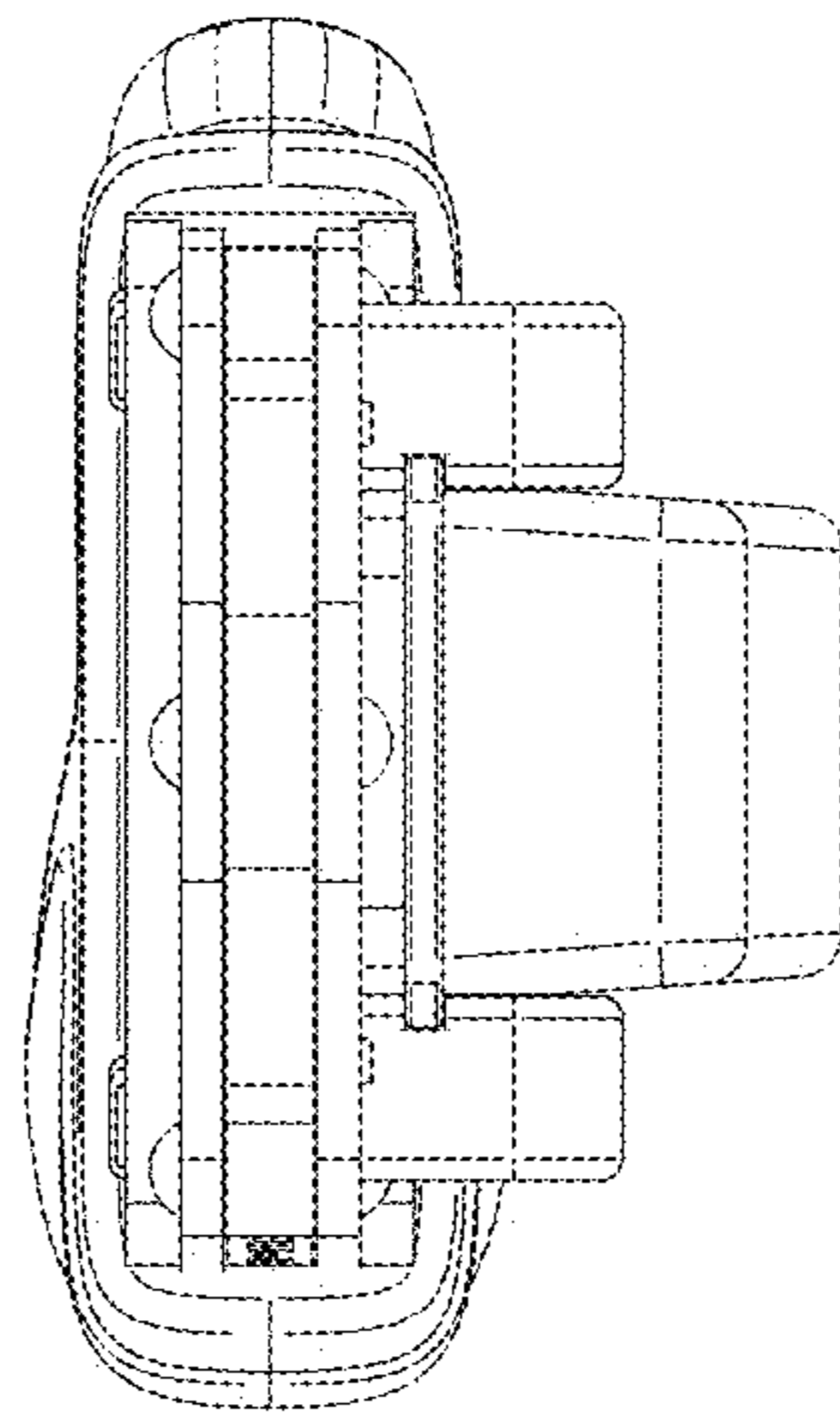

FIG. 10

