



US00D759327S

(12) **United States Design Patent**  
**Klar**

(10) **Patent No.:** **US D759,327 S**

(45) **Date of Patent:** **\*\* Jun. 14, 2016**

- (54) **DIVIDED LAUNDRY BAG**
- (71) Applicant: **Trendsformers, LLC**, West Orange, NJ (US)
- (72) Inventor: **David Klar**, West Orange, NJ (US)
- (73) Assignee: **TRENDSFORMERS**, West Orange, NJ (US)

- D363,370 S \* 10/1995 Hamdan ..... D3/216
- 6,149,041 A \* 11/2000 Perino ..... A45F 3/04  
206/315.3
- D495,459 S \* 8/2004 Purnell ..... D32/36
- 7,775,353 B2 \* 8/2010 Kagen ..... A63B 55/00  
206/315.1
- D699,031 S \* 2/2014 Clavette ..... D3/216
- D740,565 S \* 10/2015 Ludeman ..... D3/290

\* cited by examiner

(\*\*) Term: **14 Years**

*Primary Examiner* — Susan Bennett Hattan

*Assistant Examiner* — Rebecca Tsehaye

(21) Appl. No.: **29/474,915**

(74) *Attorney, Agent, or Firm* — Jonathan E. Grant; Grant Patent Service

(22) Filed: **Mar. 16, 2015**

(51) **LOC (10) Cl.** ..... **08-99**

(52) **U.S. Cl.**  
USPC ..... **D32/36**

(58) **Field of Classification Search**  
USPC ..... D32/36, 37, 35; D3/216, 215, 318, 319,  
D3/327; 206/315.1, 305.3; 383/38, 39, 40,  
383/100, 103  
CPC ..... B65D 33/00; B65D 33/008; B65D 33/01;  
A63B 55/00; A63B 55/40; A45F 3/04  
See application file for complete search history.

(57) **CLAIM**

I claim the ornamental design for a divided laundry bag, as shown.

(56) **References Cited**

U.S. PATENT DOCUMENTS

- 4,094,351 A \* 6/1978 Catenaccio ..... A45F 3/02  
224/609
- 5,050,998 A \* 9/1991 Wachtel ..... D06F 95/004  
150/117

**DESCRIPTION**

- FIG. 1—is a perspective view of a divided laundry bag;
- FIG. 2—is a side view of the divided laundry bag;
- FIG. 3—is an opposite side view of the divided laundry bag;
- FIG. 4—is a back view of the divided laundry bag;
- FIG. 5—is a front view of the divided laundry bag;
- FIG. 6—is a top plan view of the divided laundry bag; and,
- FIG. 7—is a bottom plan view of the divided laundry bag.

**1 Claim, 4 Drawing Sheets**

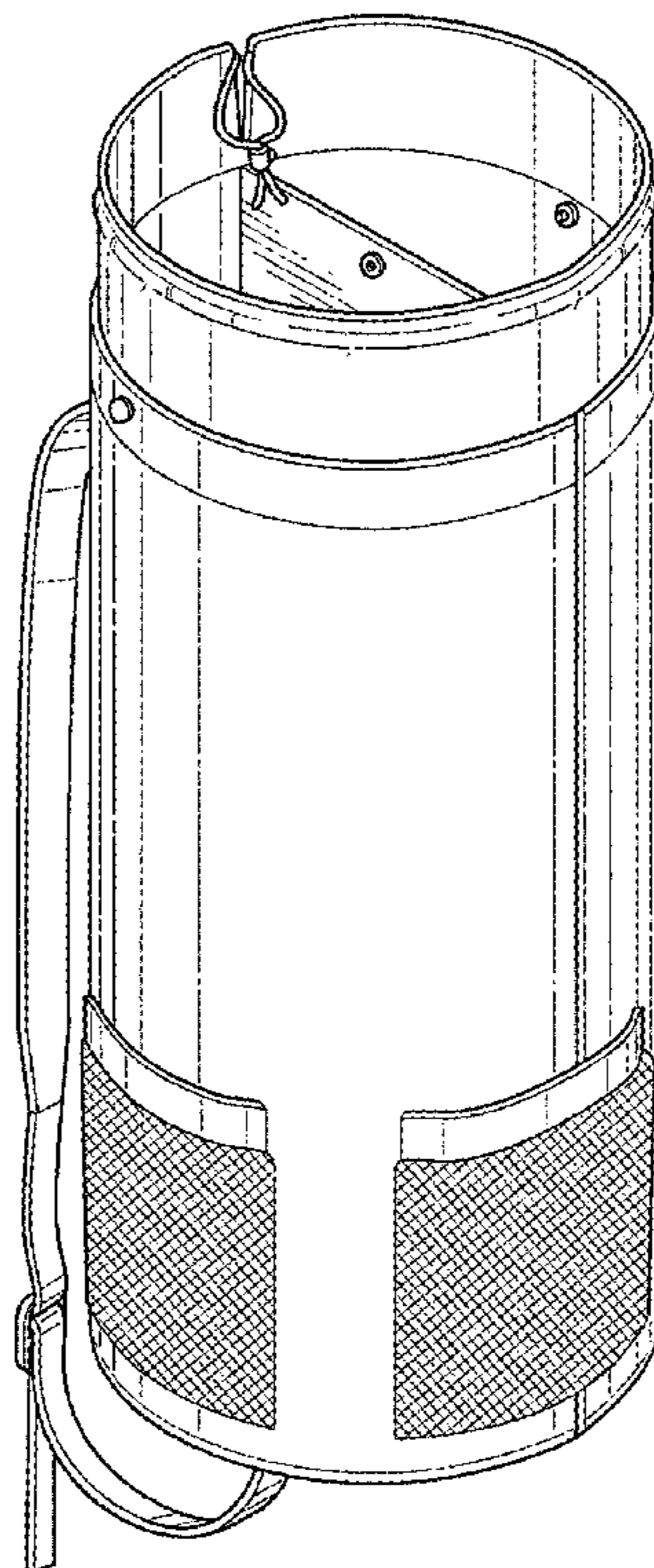

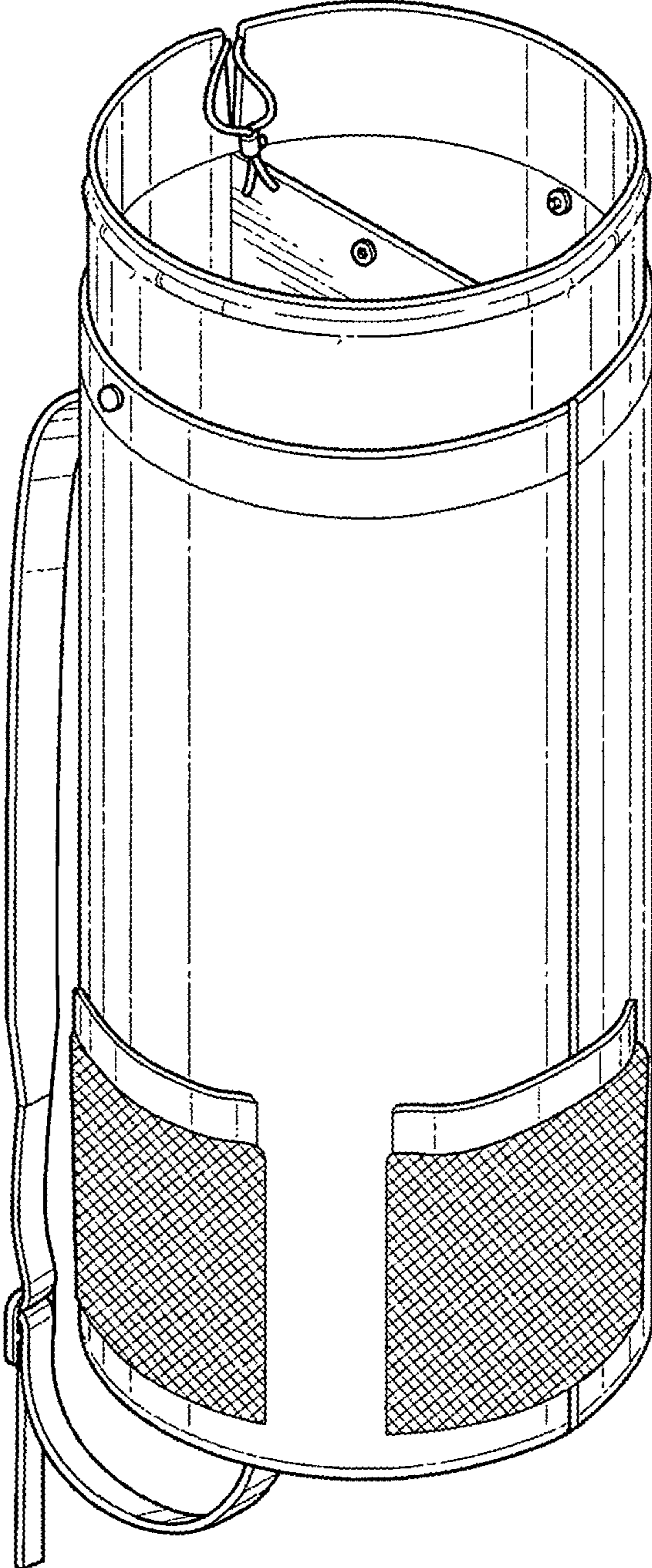

FIG. 1

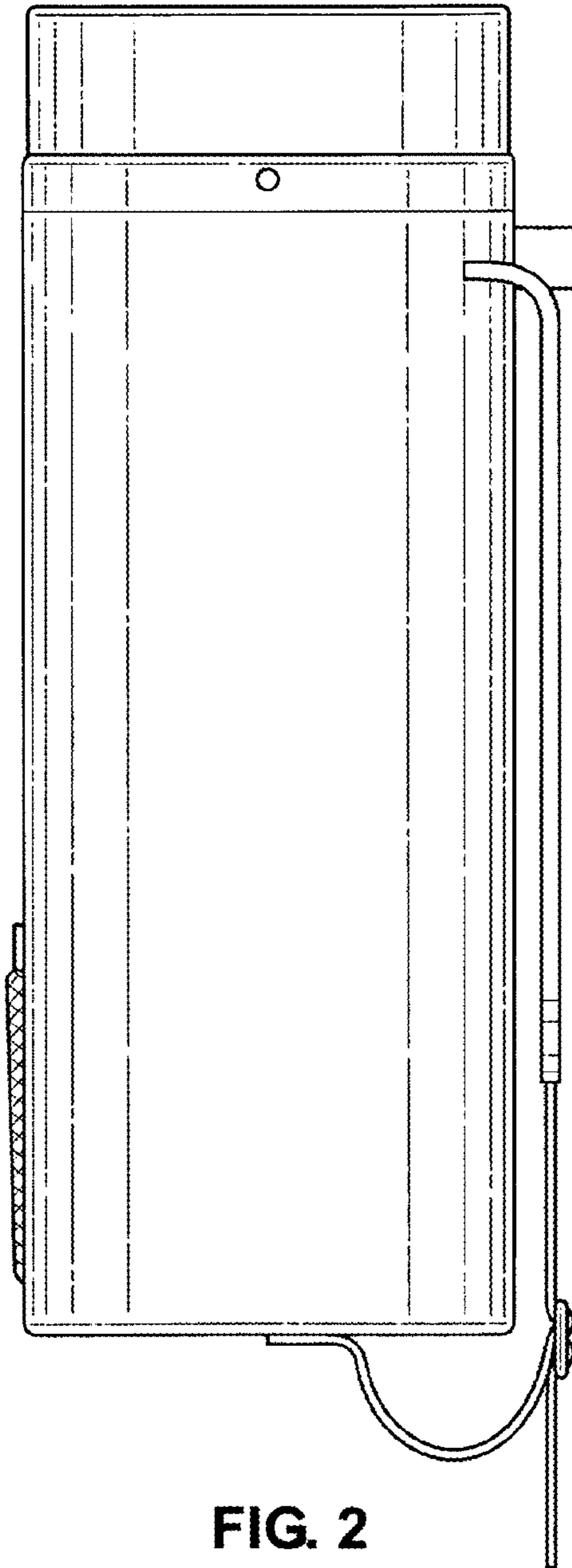

FIG. 2

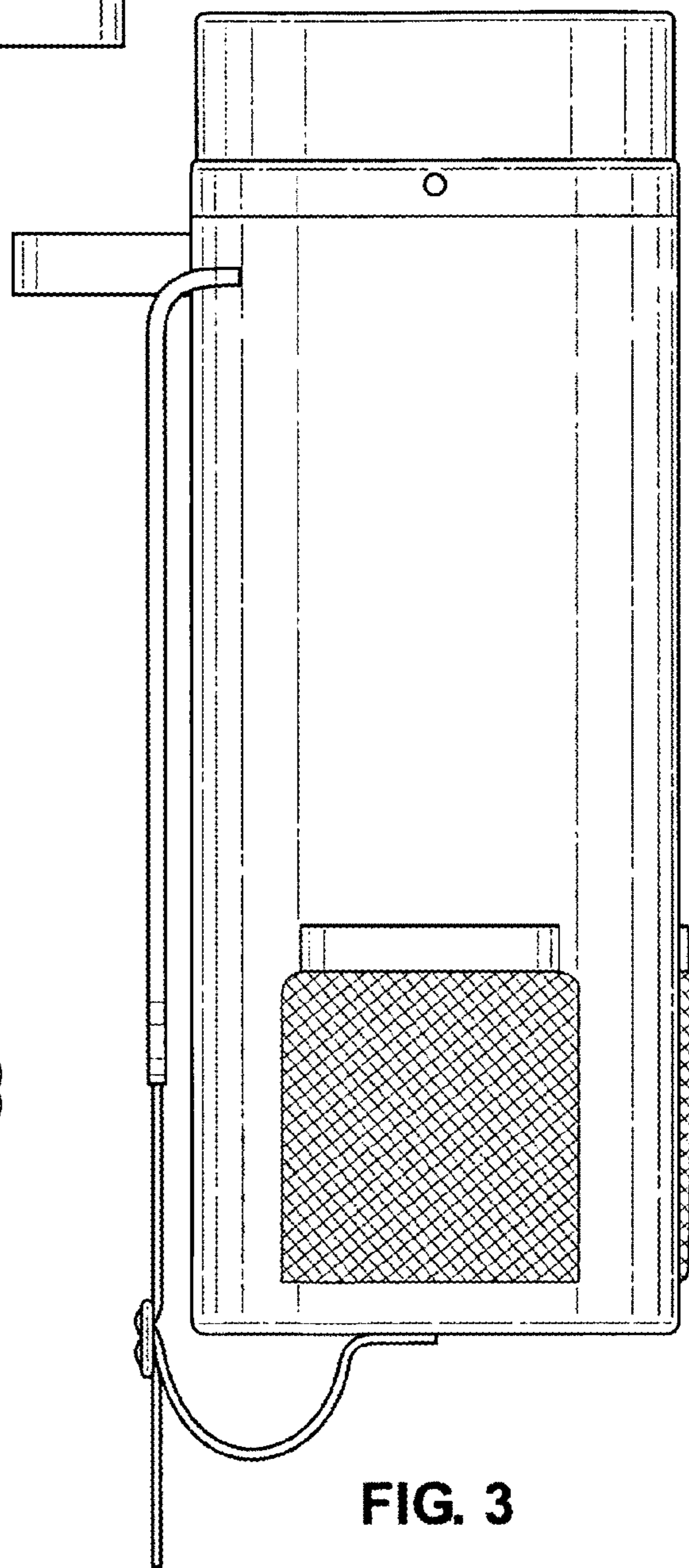
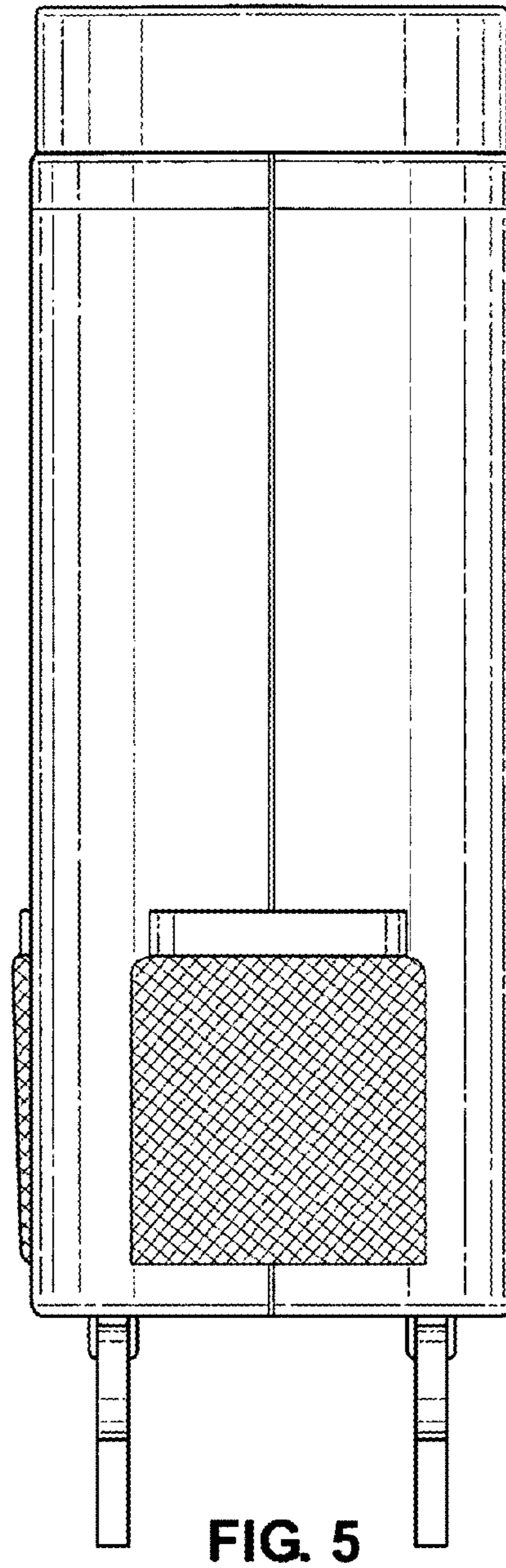
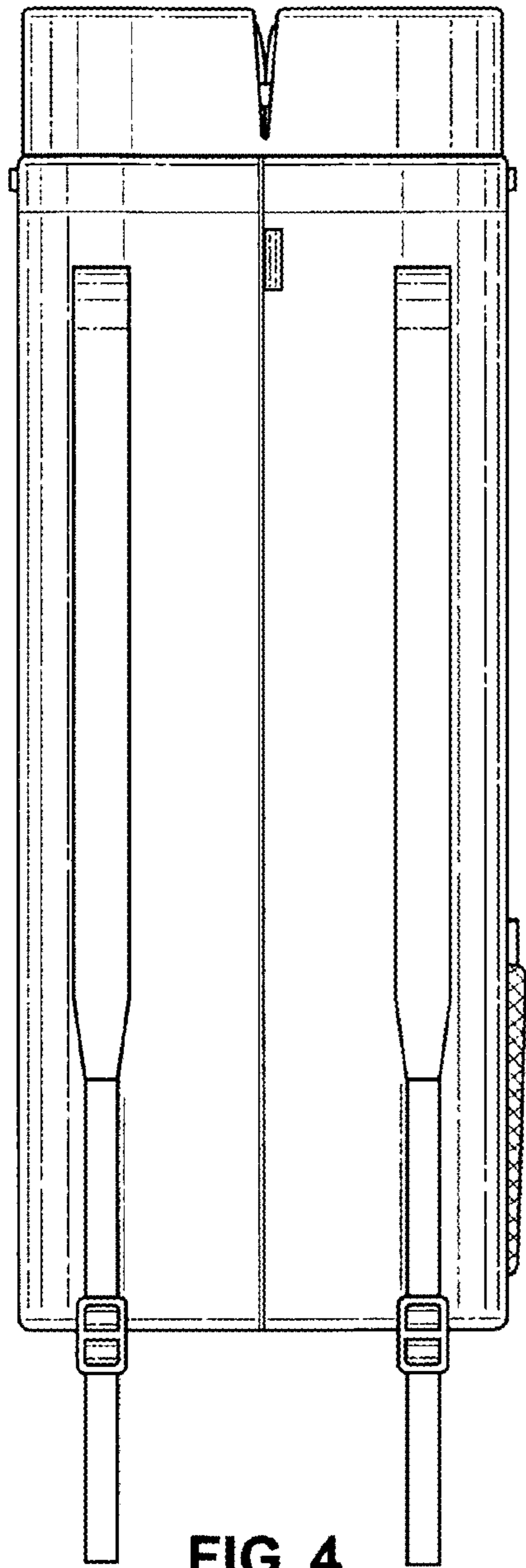

FIG. 3





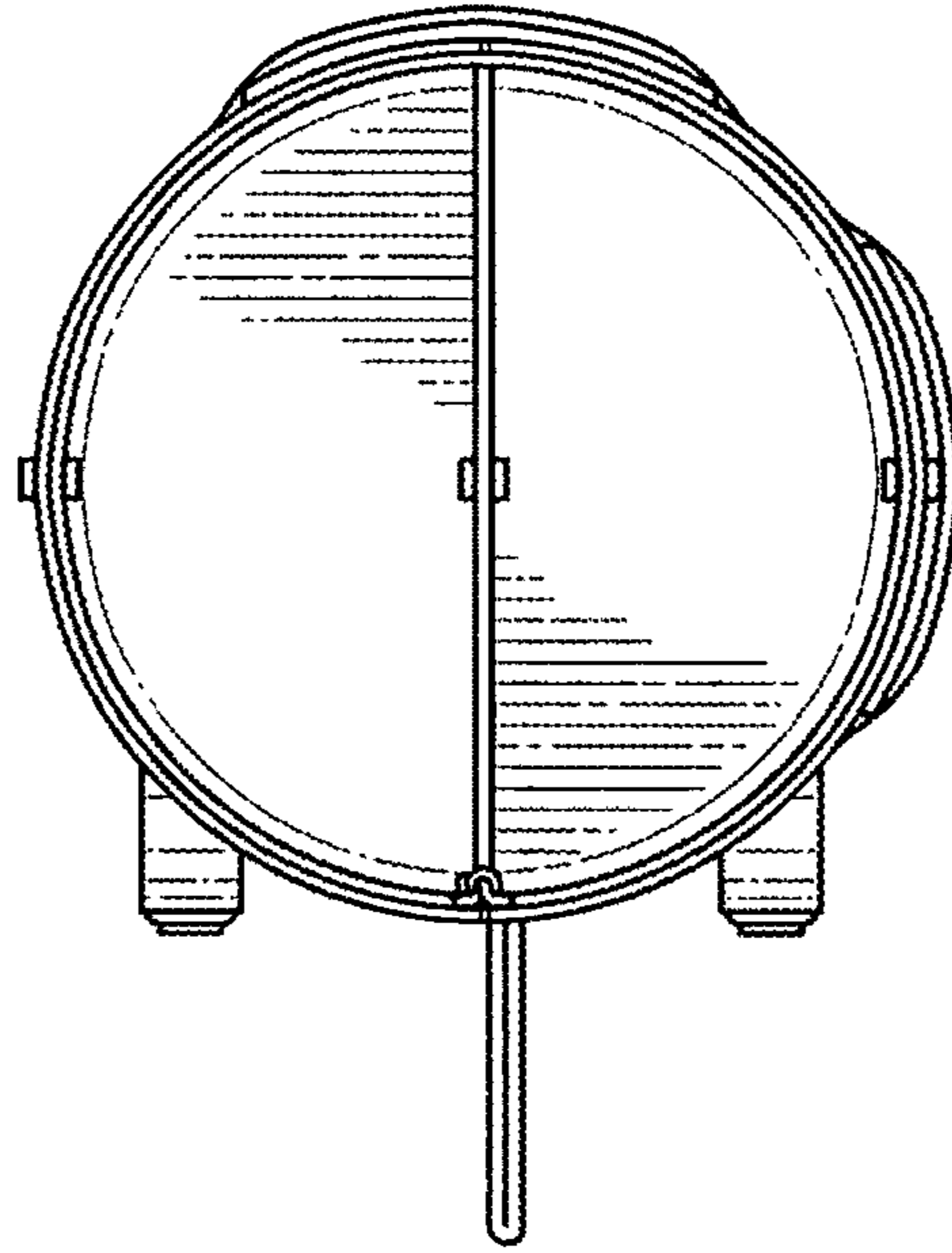

FIG. 6

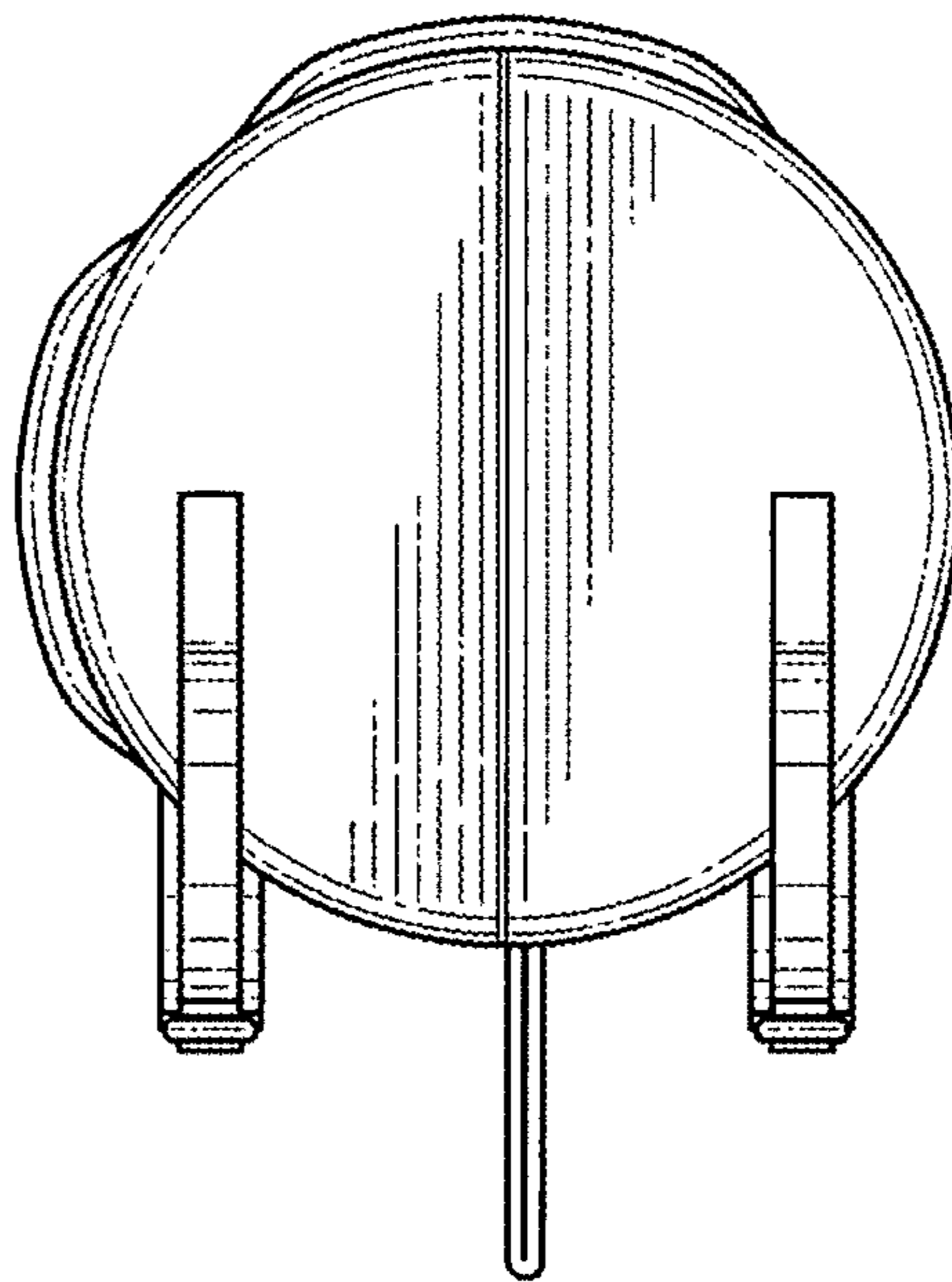

FIG. 7