



US00D759297S

(12) **United States Design Patent**  
**Liu**

(10) **Patent No.:** **US D759,297 S**  
(45) **Date of Patent:** **\*\* Jun. 14, 2016**

(54) **ELECTRONIC CIGARETTE**  
(71) Applicant: **Qiuming Liu**, Shenzhen (CN)  
(72) Inventor: **Qiuming Liu**, Shenzhen (CN)  
(73) Assignee: **Kimree Hi-Tech Inc.**, Tortola (VG)  
(\*\*) Term: **14 Years**

(21) Appl. No.: **29/488,414**  
(22) Filed: **Apr. 18, 2014**

(30) **Foreign Application Priority Data**  
Feb. 25, 2014 (CN) ..... 2014 3 0034485  
(51) **LOC (10) Cl.** ..... **27-01**  
(52) **U.S. Cl.**  
USPC ..... **D27/101**  
(58) **Field of Classification Search**  
USPC ..... D27/100, 101, 162, 165, 194; 131/270,  
131/271, 273, 329, 330, 347, 348, 360  
CPC ..... A24F 1/28; A24F 1/30; A24F 25/00;  
A24F 47/002; A24F 47/004; A24F 47/006;  
A24F 47/008; A24B 1/00  
See application file for complete search history.

(56) **References Cited**  
**U.S. PATENT DOCUMENTS**  
5,893,371 A \* 4/1999 Rose ..... A24F 47/002  
131/270  
D644,375 S \* 8/2011 Zhou ..... D27/101  
(Continued)

**FOREIGN PATENT DOCUMENTS**  
JP 1506321 9/2014

**OTHER PUBLICATIONS**  
Japanese Office Action dated Aug. 18, 2014 from corresponding Japanese Application No. 2014-008503 (with English Translation), 3 pages.

*Primary Examiner* — Rosemary K Tarcza  
*Assistant Examiner* — Christy Nemeth  
(74) *Attorney, Agent, or Firm* — Ohlandt, Greeley, Ruggiero & Perle, LLP

(57) **CLAIM**  
The ornamental design for an electronic cigarette, as shown and described.

**DESCRIPTION**

FIG. 1 is a front view of an electronic cigarette according to a first embodiment of the present application;  
FIG. 2 is a rear view of the electronic cigarette according to the first embodiment of the present application;  
FIG. 3 is a left view of the electronic cigarette according to the first embodiment of the present application;  
FIG. 4 is a right view of the electronic cigarette according to the first embodiment of the present application;  
FIG. 5 is a top view of the electronic cigarette according to the first embodiment of the present application;  
FIG. 6 is a bottom view of the electronic cigarette according to the first embodiment of the present application;  
FIG. 7 is a perspective view of the electronic cigarette according to the first embodiment of the present application;  
FIG. 8 is a front view of an electronic cigarette according to a second embodiment of the present application;  
FIG. 9 is a rear view of the electronic cigarette according to the second embodiment of the present application;  
FIG. 10 is a left view of the electronic cigarette according to the second embodiment of the present application;  
FIG. 11 is a right view of the electronic cigarette according to the second embodiment of the present application;  
FIG. 12 is a top view of the electronic cigarette according to the second embodiment of the present application;  
FIG. 13 is a bottom view of the electronic cigarette according to the second embodiment of the present application; and,  
FIG. 14 is a perspective view of the electronic cigarette according to the second embodiment of the present application.

The broken lines in the drawings are included for the purpose of illustrating environmental structure and form no part of the claimed design.

**1 Claim, 14 Drawing Sheets**

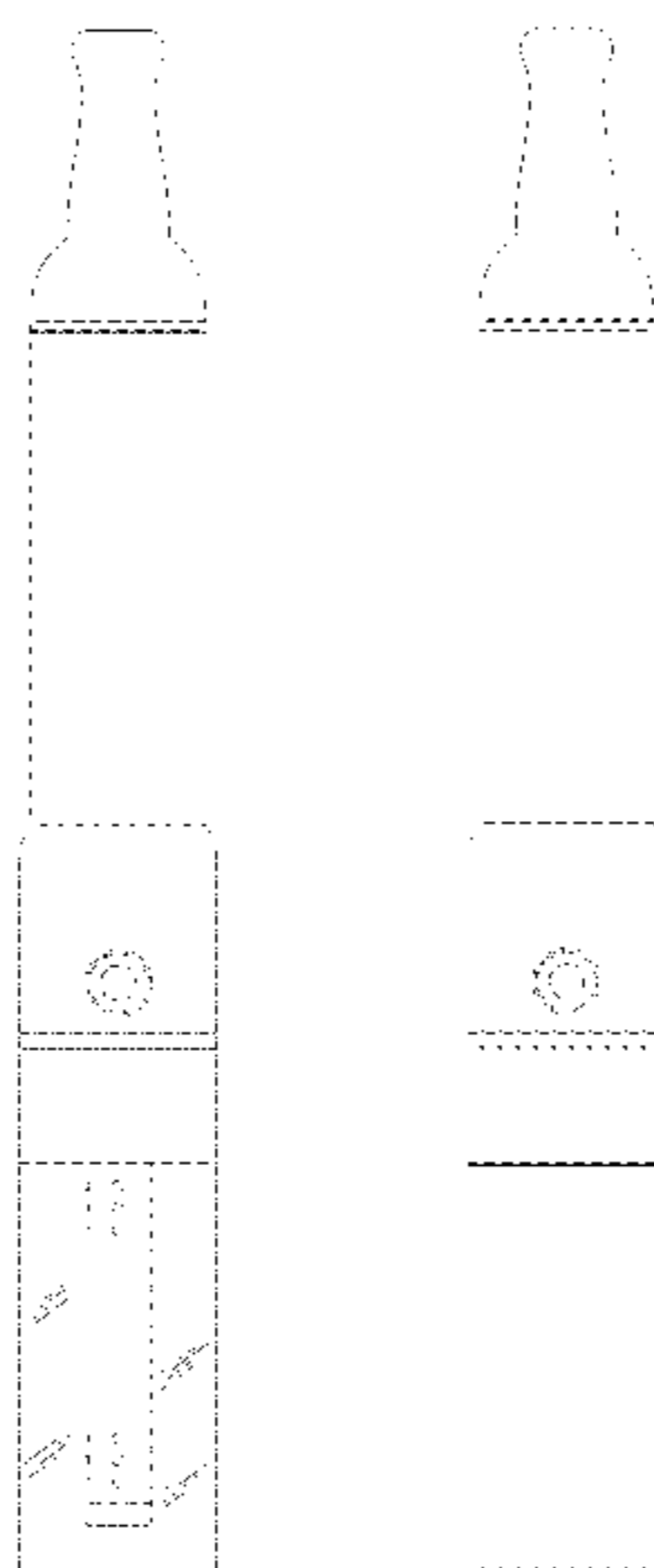

(56)

References Cited

U.S. PATENT DOCUMENTS

D688,415 S *	8/2013	Kim	.....	D27/101	2013/0333711 A1*	12/2013	Liu	.....	A24F 47/002 131/329
D693,053 S *	11/2013	Chen	.....	D27/101	2014/0041655 A1*	2/2014	Barron	.....	A61M 11/042 128/202.21
D695,450 S *	12/2013	Benassayag	.....	D24/110.5	2014/0174458 A1*	6/2014	Katz	.....	A24F 47/008 131/200
D720,094 S *	12/2014	Alima	.....	D27/101	2015/0078735 A1*	3/2015	Cormack	.....	A24F 47/00 392/395
D720,881 S *	1/2015	Liu	.....	D27/101	2015/0090253 A1*	4/2015	Farrow	.....	A24F 47/008 128/200.14
8,955,522 B1 *	2/2015	Bowen	.....	A24F 47/008 128/202.21	2015/0181944 A1*	7/2015	Li	.....	A24F 47/008 131/329
D724,782 S *	3/2015	Wu	.....	D27/101	2015/0189916 A1*	7/2015	Wu	.....	A24F 47/008 219/510
D728,155 S *	4/2015	Liu	.....	D27/101	2015/0196062 A1*	7/2015	Li	.....	A24F 47/008 131/329
D728,156 S *	4/2015	Wu	.....	D27/101	2015/0257449 A1*	9/2015	Gabbay	.....	A24F 47/008 392/386
D729,441 S *	5/2015	Hua	.....	D27/101	2015/0282528 A1*	10/2015	Liu	.....	A24F 47/008 131/329
D730,571 S *	5/2015	Chen	.....	D27/101	2015/0282529 A1*	10/2015	Li	.....	A24F 47/008 131/273
D732,239 S *	6/2015	Chen	.....	D27/101	2015/0282530 A1*	10/2015	Johnson	.....	A24F 47/002 392/387
2013/0068239 A1*	3/2013	Youn	.....	A24F 47/008 131/273					
2013/0180533 A1*	7/2013	Kim	.....	A24F 47/008 131/273					
2013/0319407 A1*	12/2013	Liu	.....	A61M 15/06 128/202.21					

\* cited by examiner

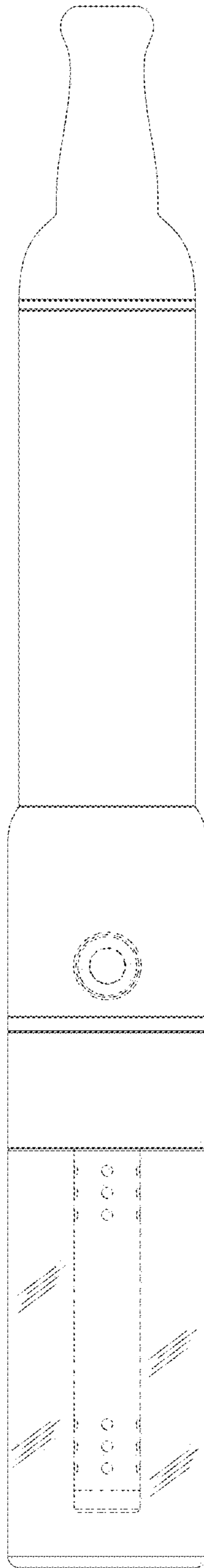

FIG. 1

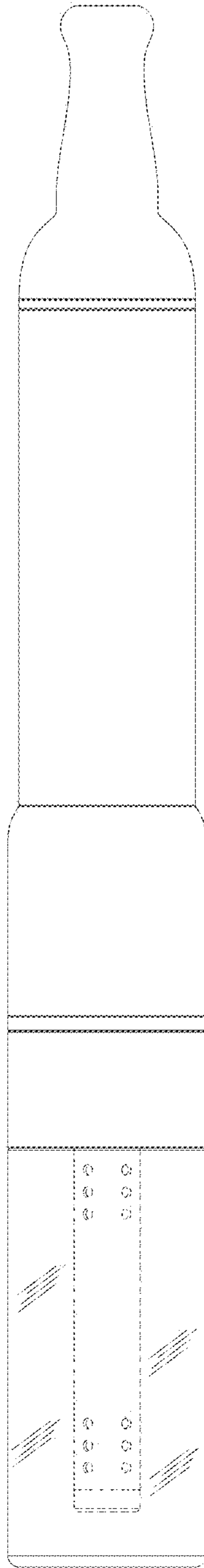

FIG. 2

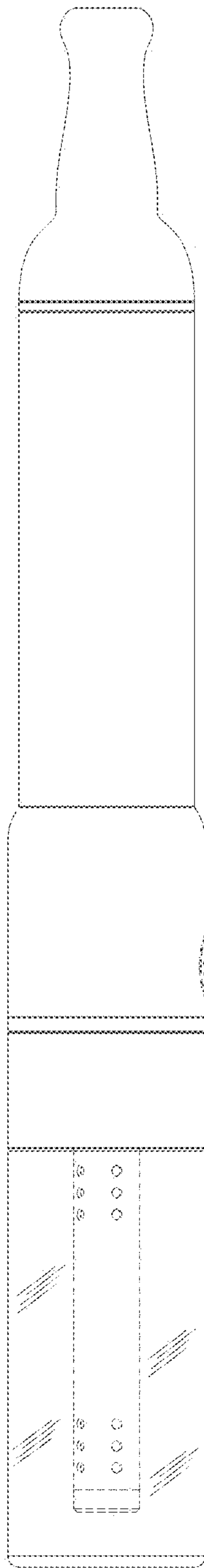

FIG. 3

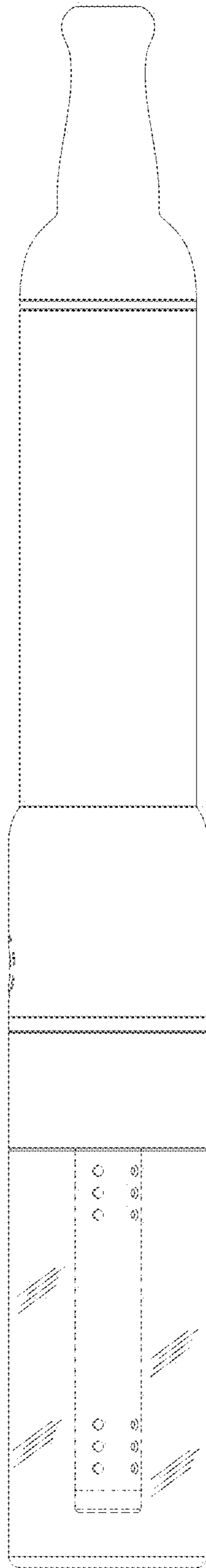
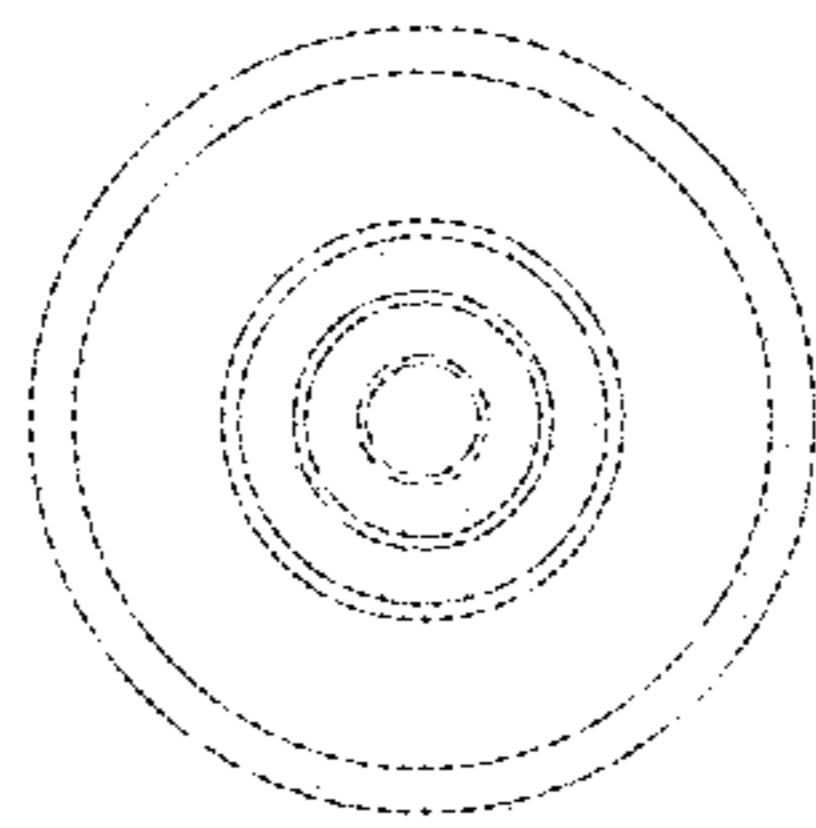
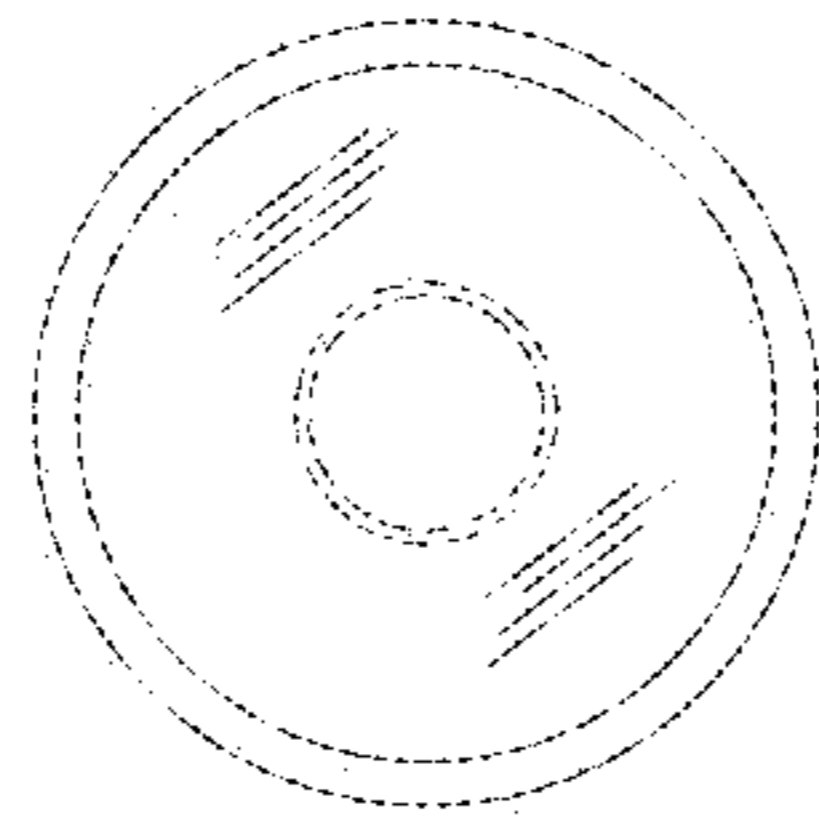

FIG. 4



*FIG. 5*



*FIG. 6*



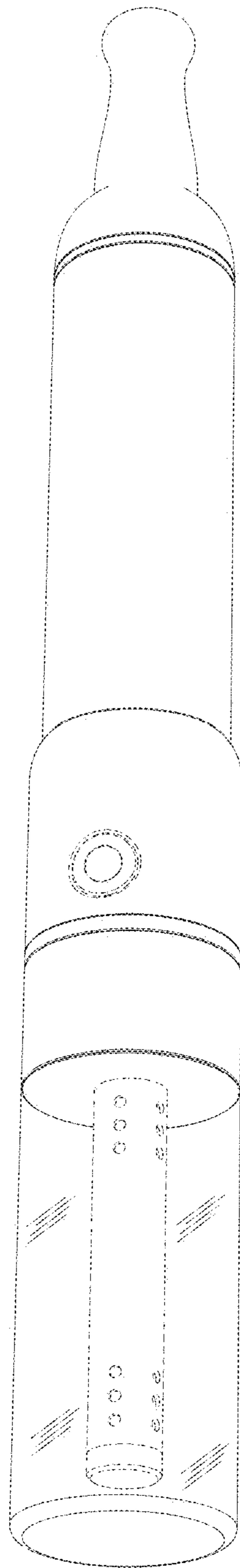
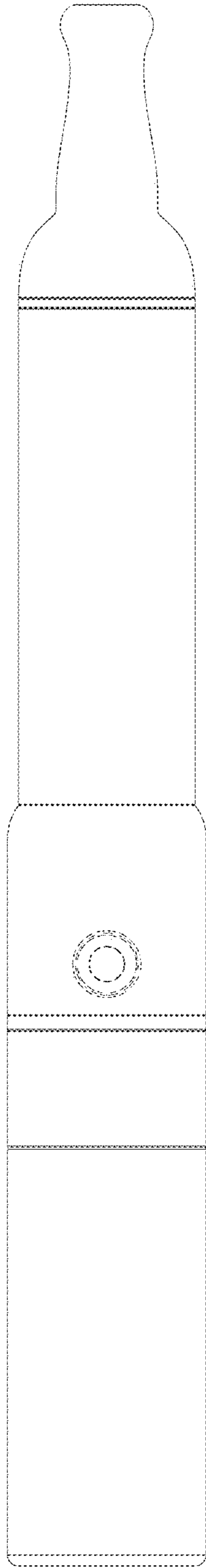
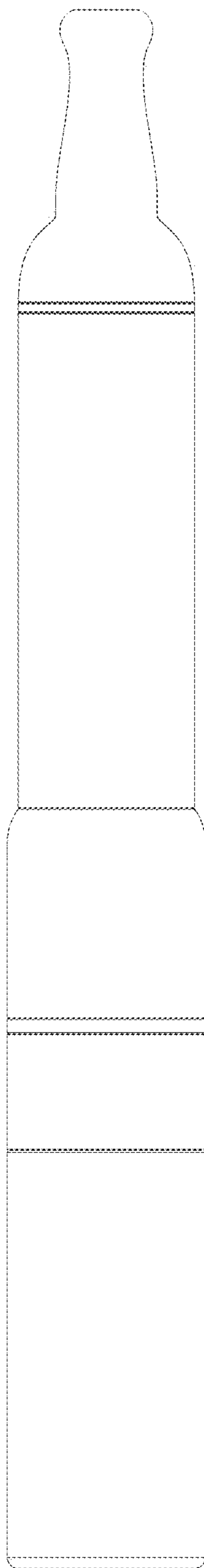

FIG. 7



*FIG. 8*



*FIG. 9*

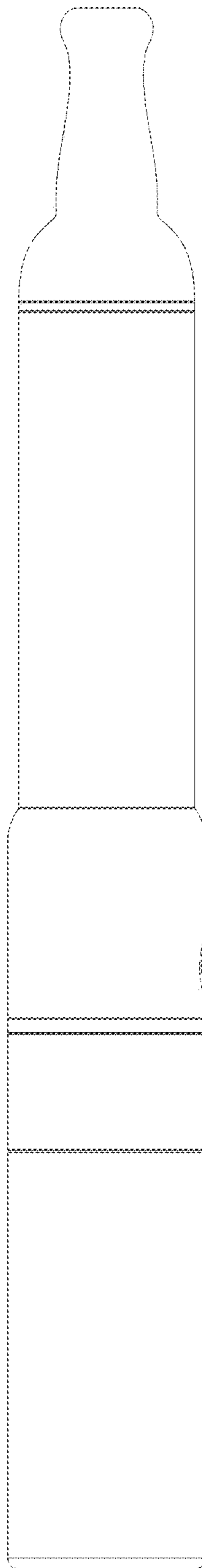

*FIG. 10*

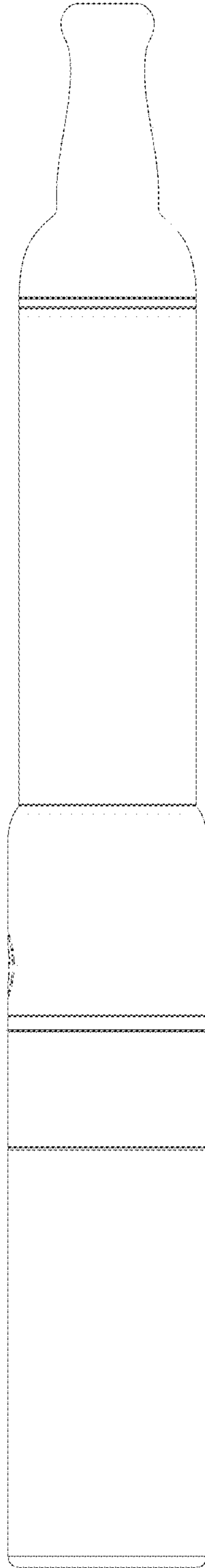

*FIG. 11*

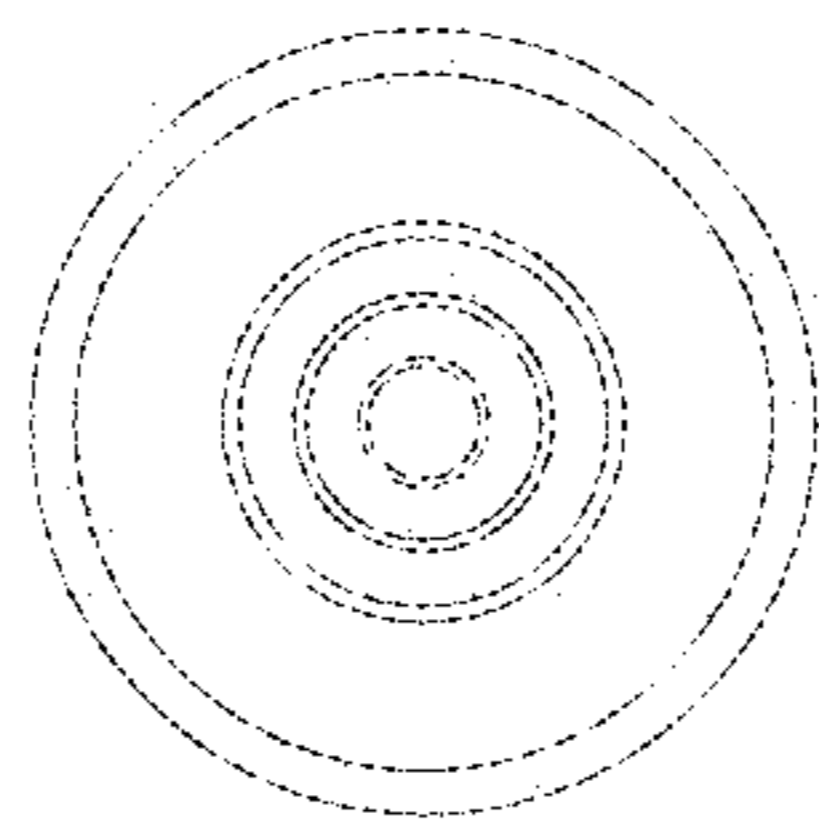

*FIG. 12*

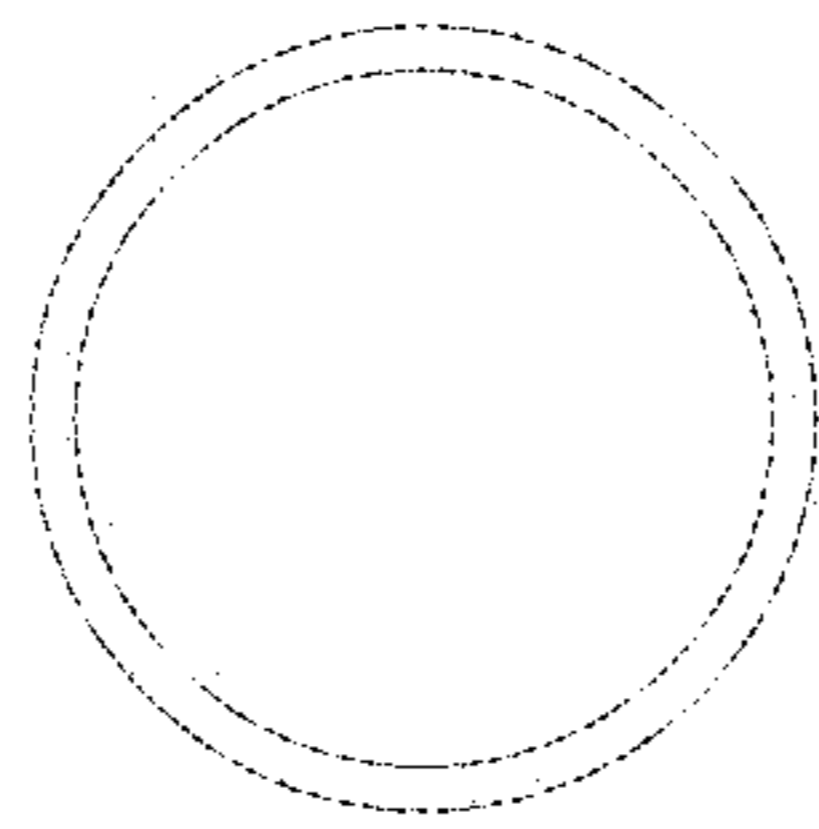

***FIG. 13***

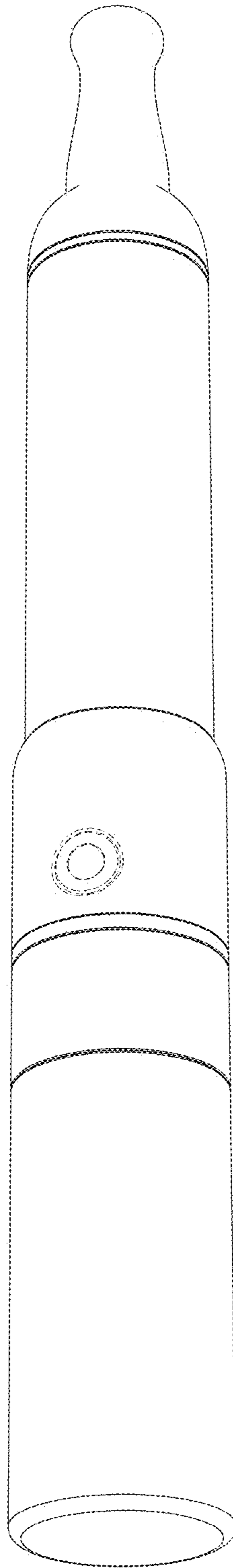

*FIG. 14*