



US00D759161S

(12) **United States Design Patent**
DeCarlo et al.

(10) **Patent No.:** **US D759,161 S**
(45) **Date of Patent:** **** Jun. 14, 2016**

(54) **FILE FOLDER**

- (71) Applicant: **Ideastream Consumer Products, LLC**,
Cleveland, OH (US)
- (72) Inventors: **Anthony J. DeCarlo**, Parma, OH (US);
Curtis Patrick Taylor, Chagrin Falls,
OH (US); **Chanseol Chung**, Hollywood,
FL (US)
- (73) Assignee: **Ideastream Consumer Products, LLC**,
Cleveland, OH (US)
- (**) Term: **14 Years**
- (21) Appl. No.: **29/491,171**
- (22) Filed: **May 19, 2014**

Related U.S. Application Data

- (63) Continuation of application No. 29/464,580, filed on
Aug. 19, 2013, now Pat. No. Des. 705,351, which is a
continuation of application No. 29/415,798, filed on
Mar. 14, 2012, now Pat. No. Des. 688,302, which is a
continuation of application No. 29/368,350, filed on
Aug. 23, 2010, now abandoned, which is a
continuation of application No. 29/299,333, filed on
Dec. 21, 2007, now Pat. No. Des. 622,320.
- (51) **LOC (10) Cl.** **19-02**
- (52) **U.S. Cl.**
USPC **D19/90**
- (58) **Field of Classification Search**
USPC D19/26-33, 86, 90, 91, 99; 229/67.1,
229/67.2, 67.3, 67.4
CPC B42F 15/007; B42F 15/0035; B42F
15/0052; B42F 15/0058; B42F 15/0094;
B42F 7/00; B42P 2241/06
See application file for complete search history.

(56)

References Cited

U.S. PATENT DOCUMENTS

1,016,789 A	2/1912	Smith	
1,060,559 A	4/1913	Rockwell	
1,336,584 A	4/1920	Soren	
1,405,818 A	2/1922	Dickerson	
1,507,433 A	9/1924	Schaffert	
1,524,348 A	1/1925	Field	
1,529,264 A	3/1925	Lewis	
1,575,673 A	3/1926	Cameron	
1,584,837 A	5/1926	Bracken	
1,697,985 A	1/1929	Lindsay	
1,759,255 A	5/1930	Greenhaus	
1,803,823 A	5/1931	Wittenmyer	
2,037,579 A	4/1936	Jonas	
2,126,471 A	8/1938	Karlen	
2,197,235 A	4/1940	Basher	
2,223,642 A	12/1940	Shaw	
2,233,687 A	3/1941	Vale	
2,248,027 A	7/1941	Maass	
2,257,052 A	9/1941	Hanna	
2,274,909 A	3/1942	Murray	
2,289,577 A	7/1942	Jonas	
2,291,675 A	8/1942	Arelt	
2,318,077 A	5/1943	Jonas	
2,323,123 A	6/1943	Donato et al.	
2,468,897 A	5/1949	Rothe	
2,484,453 A	10/1949	Halverson	
2,599,768 A	6/1952	Losch, Jr.	
2,664,089 A	12/1953	Meltzer	
2,800,907 A *	7/1957	Jonas	B42F 15/0094 211/162
2,874,699 A	2/1959	Dunleavy	
D201,935 S	8/1965	Kelley	
3,216,581 A	11/1965	Church	
3,249,111 A	5/1966	Rene	
3,288,144 A	11/1966	Hyams	
3,524,688 A	8/1970	Dean	
3,572,867 A	3/1971	Cooper	
3,605,287 A	9/1971	Jonesi	
3,639,020 A	2/1972	Nesbitt	
3,667,854 A	6/1972	Jonas	
3,680,969 A	8/1972	Gorman	
3,683,533 A	8/1972	Kelly	
2,312,717 A	3/1973	Jonas	
3,779,393 A *	12/1973	Grundell	B42F 21/065 211/126.13
3,790,242 A *	2/1974	Sullivan	B42F 15/0058 229/67.2
3,790,500 A	2/1974	Sullilvan	
3,801,175 A	4/1974	Giulie	



US D759,161 S

3,826,582 A	7/1974	Podosek		5,492,268 A	2/1996	Biddle	
3,850,488 A	11/1974	Elias et al.		5,494,161 A	2/1996	Herbst	
3,857,492 A	12/1974	Michaelis et al.		5,503,435 A	4/1996	Kline	
3,865,445 A	2/1975	Dean et al.		5,503,487 A	4/1996	Ong	
3,936,201 A	2/1976	Kenney et al.		5,515,980 A	5/1996	Fotioo	
3,950,048 A	4/1976	Unti et al.		5,570,792 A	11/1996	Huang	
3,957,321 A	5/1976	Rose		5,570,833 A	11/1996	Dusek	
D240,395 S	7/1976	Feldmahr		5,599,128 A	2/1997	Steiner	
3,980,360 A *	9/1976	Wright	B42F 15/0058 229/67.2	5,626,368 A	5/1997	St. Romain	
				D382,301 S	8/1997	Baumgarten	
4,009,784 A	3/1977	Elias et al.		5,692,673 A	12/1997	De Safey	
4,031,646 A	6/1977	de Nouel		5,707,001 A	1/1998	Mark et al.	
4,053,057 A	10/1977	Snowden		5,721,531 A	2/1998	Garver et al.	
4,114,963 A	9/1978	Menahem		5,722,692 A	3/1998	Abramov	
D250,715 S	1/1979	Hedstrom et al.		5,743,566 A	4/1998	Hunter	
4,186,504 A	2/1980	Avery		5,749,479 A	5/1998	Belokin et al.	
4,208,146 A	6/1980	Schudy		5,758,780 A	6/1998	Baumgarten	
4,255,888 A	3/1981	Bastogne		5,779,331 A	7/1998	Fox et al.	
4,288,170 A	9/1981	Barber		5,813,734 A	9/1998	Ong	
4,294,028 A	10/1981	Reymond		5,873,642 A	2/1999	Domenig	
4,395,058 A	7/1983	Terrell		D407,441 S	3/1999	Greenberg et al.	
4,400,103 A	8/1983	Daughters		5,899,626 A	5/1999	Hatano et al.	
4,400,107 A	8/1983	Pitts		5,924,812 A	7/1999	Goldman	
4,403,816 A	9/1983	Da Cruz Garcia		5,941,450 A	8/1999	De Safey	
4,420,086 A	12/1983	Bardes		5,942,293 A	8/1999	Occhipinti et al.	
4,449,270 A	5/1984	Brabant		5,947,525 A	9/1999	Pollman	
4,477,013 A	10/1984	Herrin		5,971,166 A	10/1999	Ong	
4,487,520 A	12/1984	Maier-Hunke et al.		5,993,099 A	11/1999	Greenberg et al.	
4,489,836 A	12/1984	Terrell		D417,697 S	12/1999	Long	
4,523,775 A	6/1985	Reist		6,004,062 A	12/1999	Hunter	
4,526,277 A	7/1985	Snowden et al.		D419,358 S	1/2000	Marcon	
D282,758 S	2/1986	Hirsch		6,039,354 A	3/2000	Mangler	
4,575,273 A	3/1986	Gerriet		6,039,473 A	3/2000	Bond	
4,576,328 A	3/1986	Snider et al.		6,068,423 A	5/2000	Owen	
4,624,480 A	11/1986	Marthaler et al.		6,071,030 A	6/2000	Hunter et al.	
4,645,237 A	2/1987	Squire et al.		6,099,189 A	8/2000	Owen et al.	
4,681,232 A	7/1987	Du Corday		6,108,953 A	8/2000	Hall	
4,721,211 A	1/1988	Lundberg		6,182,827 B1	2/2001	Su	
4,722,626 A	2/1988	Abildgaard		6,227,746 B1	5/2001	Long et al.	
D298,265 S	10/1988	Snider et al.		6,340,178 B1	1/2002	Nakanishi	
4,784,508 A	11/1988	Shannon		6,409,409 B2	6/2002	Bauman	
4,806,397 A	2/1989	Horwitz		6,453,589 B1	9/2002	Schwartz	
4,830,268 A	5/1989	Pitts		6,508,376 B1	1/2003	Chiang	
4,893,745 A	1/1990	Weber		6,619,773 B2	9/2003	Amsterdam	
4,901,867 A	2/1990	Petty, Jr.		6,808,104 B2	10/2004	Cobble	
4,923,111 A	5/1990	Down		6,830,156 B2	12/2004	MacKelvie	
4,923,217 A	5/1990	Pressler		6,926,158 B1	8/2005	Brown	
4,932,683 A	6/1990	Perazza		7,025,382 B2	4/2006	Wiggins	
4,950,096 A	8/1990	Gilder		D522,576 S	6/2006	Smith	
D312,277 S	11/1990	Moor		7,059,483 B2	6/2006	Scudder	
4,979,626 A	12/1990	Pitts		7,100,775 B2	9/2006	Yeh	
5,025,979 A	6/1991	Dellacrocce		7,108,169 B2	9/2006	Balzer	
5,048,697 A	9/1991	Payne		D530,743 S	10/2006	Ong	
5,052,646 A	10/1991	Hawes		7,140,644 B2	11/2006	Hanes	
5,066,045 A	11/1991	Hawes		D536,701 S	2/2007	Gusmorino et al.	
D322,284 S	12/1991	Whaley et al.		7,210,659 B2	5/2007	Lawson et al.	
5,111,941 A	5/1992	Hillestad		7,232,537 B2	6/2007	Bullock	
5,119,950 A	6/1992	Takemura		7,243,884 B2 *	7/2007	Lawson	D06F 95/002 211/12
5,141,485 A	8/1992	Welt					
5,154,527 A	10/1992	Blessing		D559,309 S	1/2008	Rydzewski	
5,187,888 A	2/1993	O'Brien et al.		D568,930 S	5/2008	Declerck	
5,197,762 A	3/1993	Abramov		7,383,652 B2	6/2008	Glasberg	
5,205,626 A	4/1993	Fotioo		D577,766 S	9/2008	Rydzewski	
D337,784 S	7/1993	Wyant		D582,192 S	12/2008	Pan	
5,226,734 A	7/1993	Scott et al.		D588,634 S	3/2009	Wittmeyer et al.	
5,248,290 A	9/1993	Hawes et al.		D597,555 S	8/2009	Ozzie et al.	
5,256,130 A	10/1993	Kachel et al.		D601,189 S	9/2009	Riesterer et al.	
5,261,636 A	11/1993	Hawes et al.		7,757,870 B2	7/2010	Lin et al.	
5,275,439 A	1/1994	Hawes et al.		D622,320 S	8/2010	Decarlo et al.	
5,295,622 A	3/1994	Lorber		7,900,813 B2	3/2011	Dodson	
5,299,879 A	4/1994	Burrow		7,954,694 B2	6/2011	DeCarlo et al.	
5,311,685 A	5/1994	Wyant		8,104,669 B2	1/2012	Christensen et al.	
5,328,259 A	7/1994	Meriaux		8,152,050 B2	4/2012	Busam	
5,358,125 A	10/1994	Blessing		D689,548 S *	9/2013	Klosky	D19/90
5,358,126 A	10/1994	Jones et al.		8,567,659 B2	10/2013	Chung	
5,393,154 A	2/1995	Hubbell		D705,351 S	5/2014	DeCarlo et al.	
5,401,058 A	3/1995	Holmberg		9,156,303 B2	10/2015	DeCarlo et al.	
5,405,020 A	4/1995	Fotioo		2002/0129522 A1	9/2002	Yamamoto et al.	
5,487,617 A	1/1996	Cole et al.		2003/0010815 A1	1/2003	Balzer	

2005/0000839	A1	1/2005	Densley
2005/0019094	A1	1/2005	Hayes et al.
2005/0146750	A1	7/2005	Moroney et al.
2005/0199685	A1	9/2005	Mark et al.
2005/0206954	A1	9/2005	Schwier
2006/0016112	A1	1/2006	McCarthy et al.
2006/0059755	A1	3/2006	Valade et al.
2006/0226205	A1	10/2006	O'Leary et al.
2008/0164302	A1	7/2008	Ho
2008/0218044	A1	9/2008	Unda et al.
2009/0045246	A1	2/2009	Dodson et al.
2009/0283577	A1	11/2009	Dodson
2011/0155793	A1	6/2011	Dodson

FOREIGN PATENT DOCUMENTS

CA	126570	2/2011
CA	134439	2/2011
CA	134440	2/2011
CA	137054	2/2011
DE	237284	9/1986
DE	29801949	6/1998
FR	908167	4/1946
FR	1412327	9/1965
FR	2621865	4/1989
FR	2826910	1/2003
GB	619391	3/1949

OTHER PUBLICATIONS

Ideastream Findit File Folders, 1/3 Cut, 11 Point Stock, Letter Size, Manila, 80/pack (FD07046), www.amazon.com, 4 pages, downloaded on Jan. 4, 2011.

Smead Manila Folder, Letter Size, 11 point, 1/3-Cut Tab, 1100 per Box (10330), Amazon.com, 5 pages, downloaded on Jan. 3, 2011, Nov. 1, 2006.

International Search Report for International Patent Application No. PCT/US2008/054549 dated Sep. 23, 2008.

Written Opinion for International Patent Application No. PCT/US2008/054549 dated Sep. 23, 2008.

2-Tone File Folders, 1/3 Cut, Top Tab, Letter, Light Yellow, by Esselte Pendaflex Corp., Amazon.com, 3 pages, downloaded Jan. 3, 2011, Apr. 18, 2006.

Ideastream 1/3 Cut Tab File Folder—Letter—8.5" × 11"—Manila IDEFT007046, 2 pages, www.compsource.com, downloaded Jan. 4, 2011.

Find It Hanging File Folder with Innovative Top Rail, #FT07044, 3 pages, www.amazon.com, printed from Internet on Aug. 14, 2009.

Find It Tab View Hanging File Folder, #FT07033, ASIN: 8001 CDZ4UO, 4 pages, www.amazon.com, printed from internet on Aug. 14, 2009.

Ideastream Findit Hanging File Folder with Innovative Top Rail, #FT07033, 3 pages on www.thenerds.net, printed from internet on Apr. 4, 2009.

One Folder, item #IDEFT07046, www.seaflog.com, 2 pages, downloaded on Jan. 4, 2011.

International Preliminary Report on Patentability for International Patent Application No. PCT/US2008/054549 dated Aug. 26, 2009.

Office Action for related Canadian Patent Application No. 2,679,058 dated Mar. 28, 2014.

Notice of Allowance for related Canadian Patent Application No. 2,679,058 dated Feb. 25, 2015.

* cited by examiner

Primary Examiner — Elizabeth Albert

(74) Attorney, Agent, or Firm — Calfee, Halter & Griswold LLP

(57)

CLAIM

The ornamental design for a file folder, as shown and described.

DESCRIPTION

FIG. 1 is a top plan view of a first embodiment of the file folder of the new design;

FIG. 2 is a bottom plan view of the file folder of FIG. 1;

FIG. 3 is a rear elevational view of the file folder of FIG. 1;

FIG. 4 is a front elevational view of the file folder of FIG. 1;

FIG. 5 is a right side elevational view of the file folder of FIG. 1;

FIG. 6 is a left side elevational view of the file folder of FIG. 1;

FIG. 7 is a top plan view of the file folder of FIG. 1;

FIG. 8 is a top plan view of the file folder of FIG. 1;

FIG. 9 is an isometric view of the file folder of FIG. 1;

FIG. 10 is a top plan view of a second embodiment of a file folder of the new design;

FIG. 11 is a bottom plan view of the file folder of FIG. 10;

FIG. 12 is a rear elevational view of the file folder of FIG. 10;

FIG. 13 is a front elevational view of the file folder of FIG. 10;

FIG. 14 is a right side elevational view of the file folder of FIG. 10;

FIG. 15 is a left side elevational view of the file folder of FIG. 10;

FIG. 16 is a top plan view of the file folder of FIG. 10;

FIG. 17 is a top plan view of the file folder of FIG. 10;

FIG. 18 is an isometric view of the file folder of FIG. 10;

FIG. 19 is a top plan view of a third embodiment of a file folder of the new design;

FIG. 20 is a bottom plan view of the file folder of FIG. 19;

FIG. 21 is a rear elevational view of the file folder of FIG. 19;

FIG. 22 is a front elevational view of the file folder of FIG. 19;

FIG. 23 is a right side elevational view of the file folder of FIG. 19;

FIG. 24 is a left side elevational view of the file folder of FIG. 19;

FIG. 25 is a top plan view of the file folder of FIG. 19;

FIG. 26 is a top plan view of the file folder of FIG. 19;

FIG. 27 is an isometric view of the file folder of FIG. 19;

FIG. 28 is a top plan view of a fourth embodiment of a file folder of the new design;

FIG. 29 is a bottom plan view of the file folder of FIG. 28;

FIG. 30 is a rear elevational view of the file folder of FIG. 28;

FIG. 31 is a front elevational view of the file folder of FIG. 28;

FIG. 32 is a right side elevational view of the file folder of FIG. 28;

FIG. 33 is a left side elevational view of the file folder of FIG. 28;

FIG. 34 is a top plan view of the file folder of FIG. 28;

FIG. 35 is a top plan view of the file folder of FIG. 28; and,

FIG. 36 is an isometric view of the file folder of FIG. 28.

The broken lines in the drawings are included for the purpose of showing portions of the file folder that form no part of the claimed design.

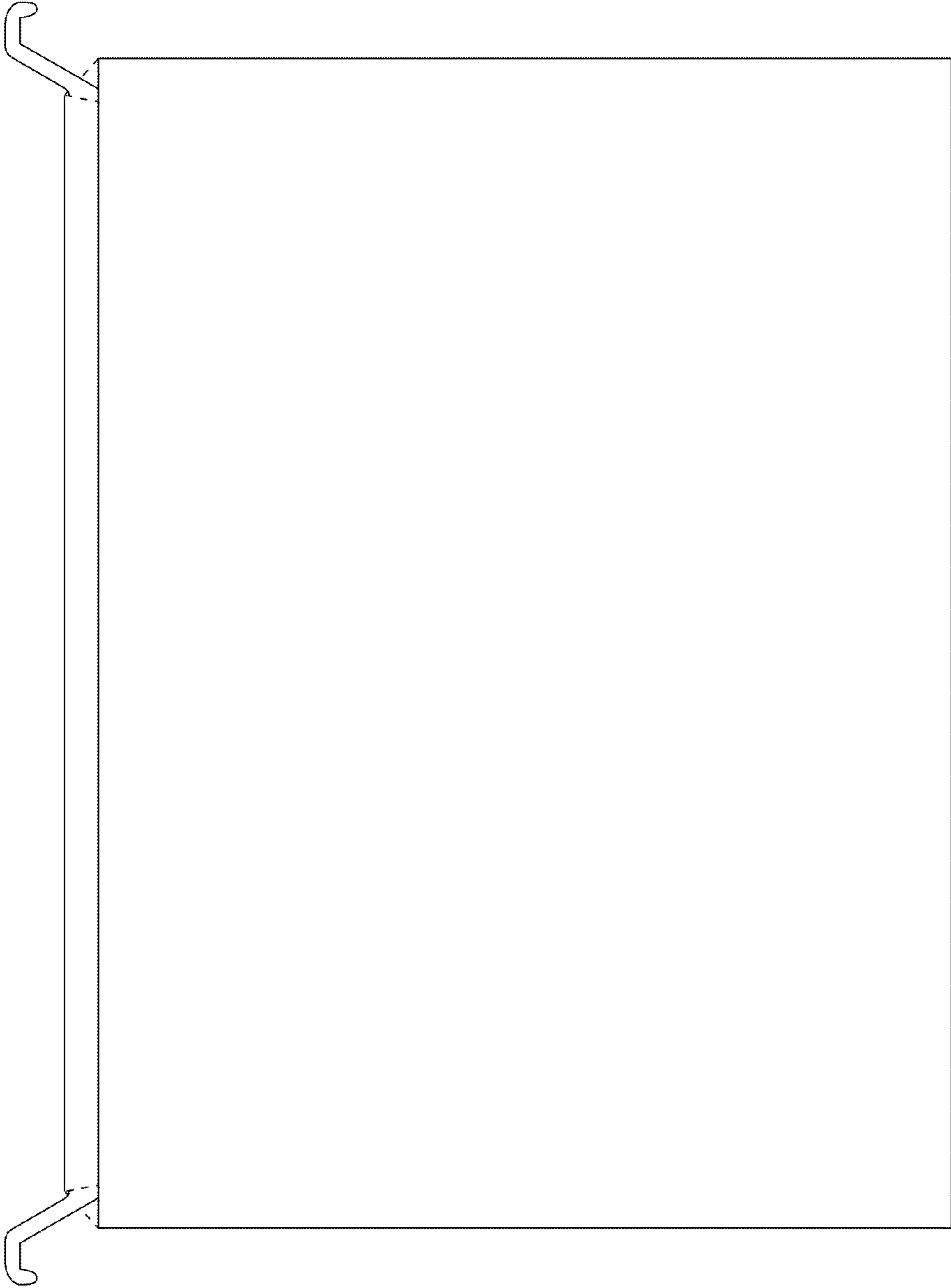

Fig. 1

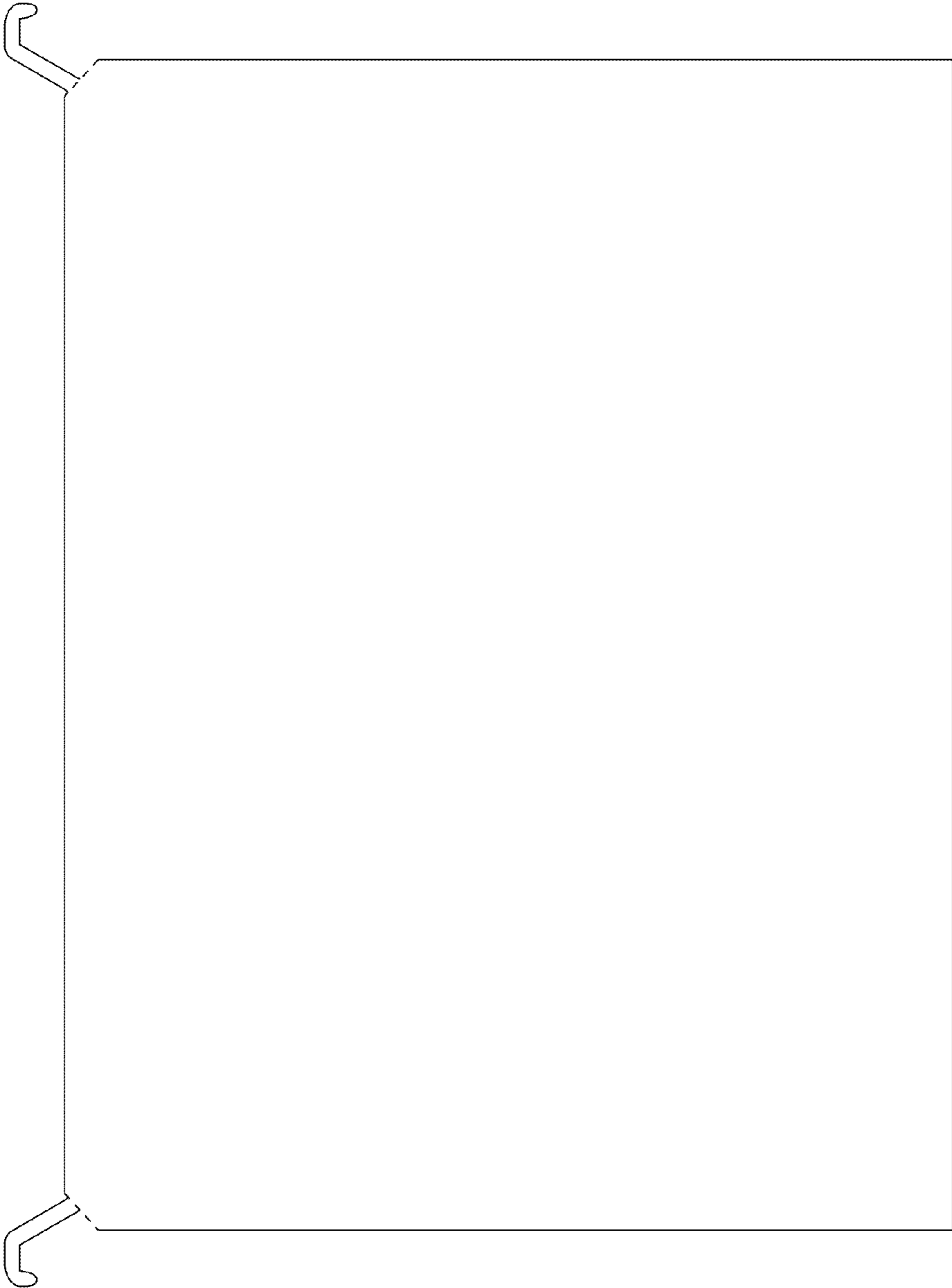

Fig. 2

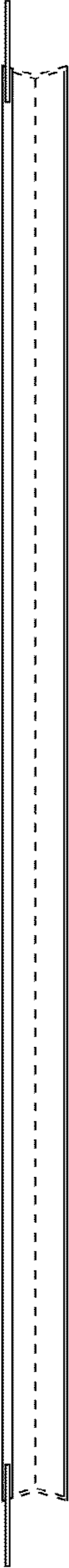

Fig. 3

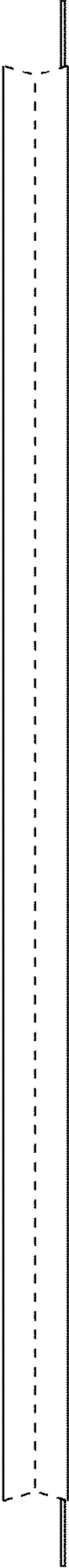

Fig. 4



Fig. 5



Fig. 6

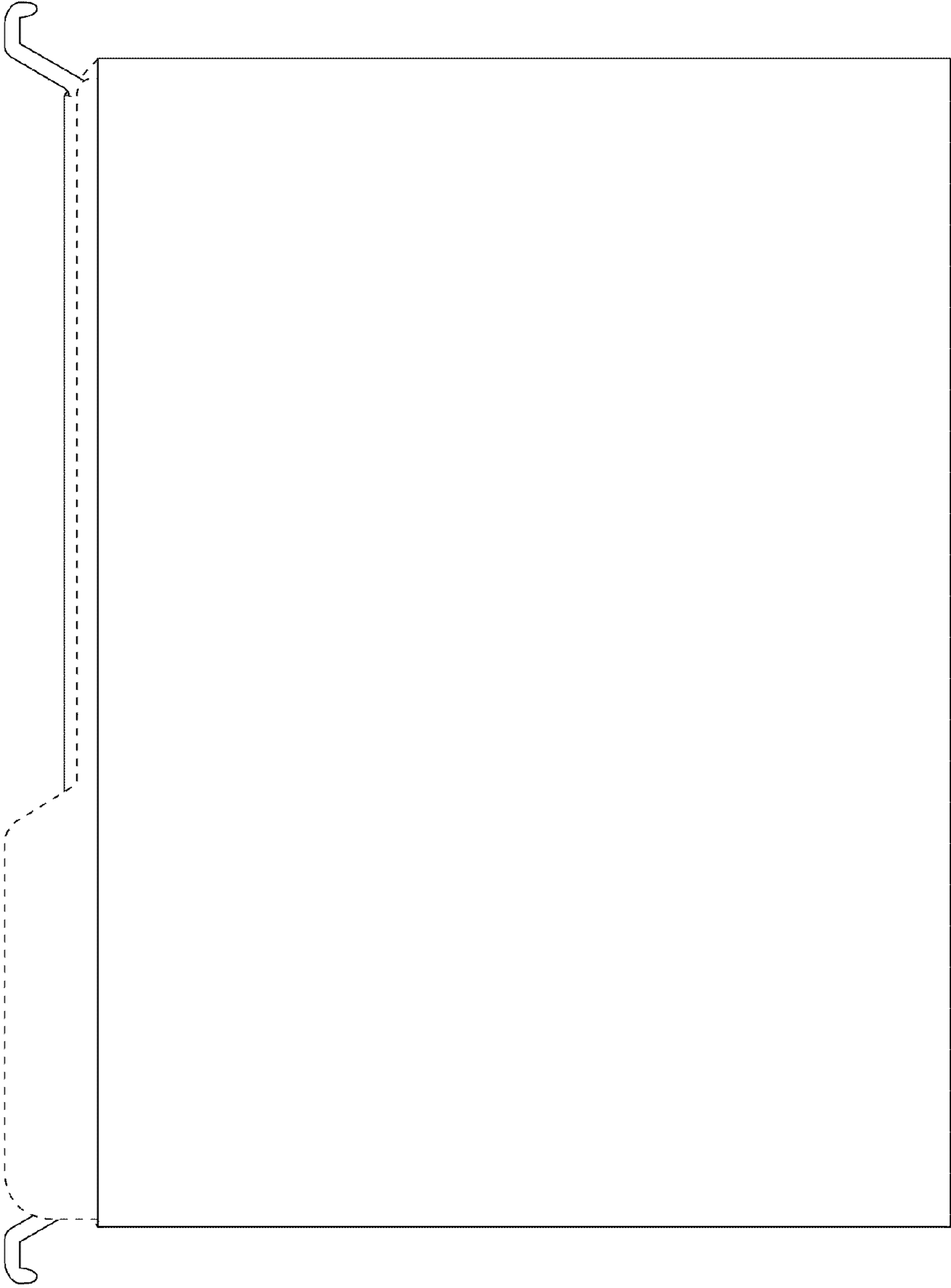

Fig. 7

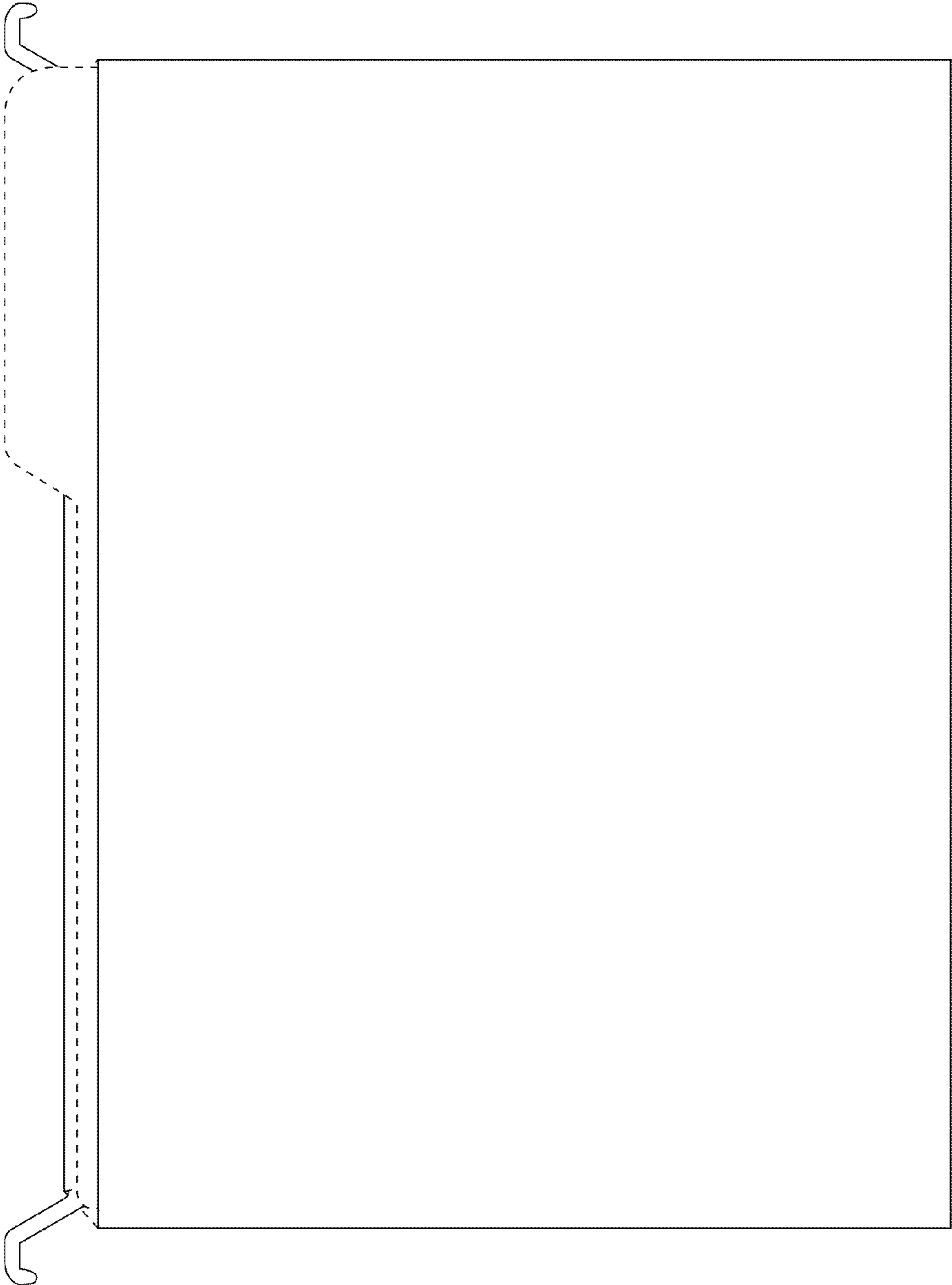

Fig. 8

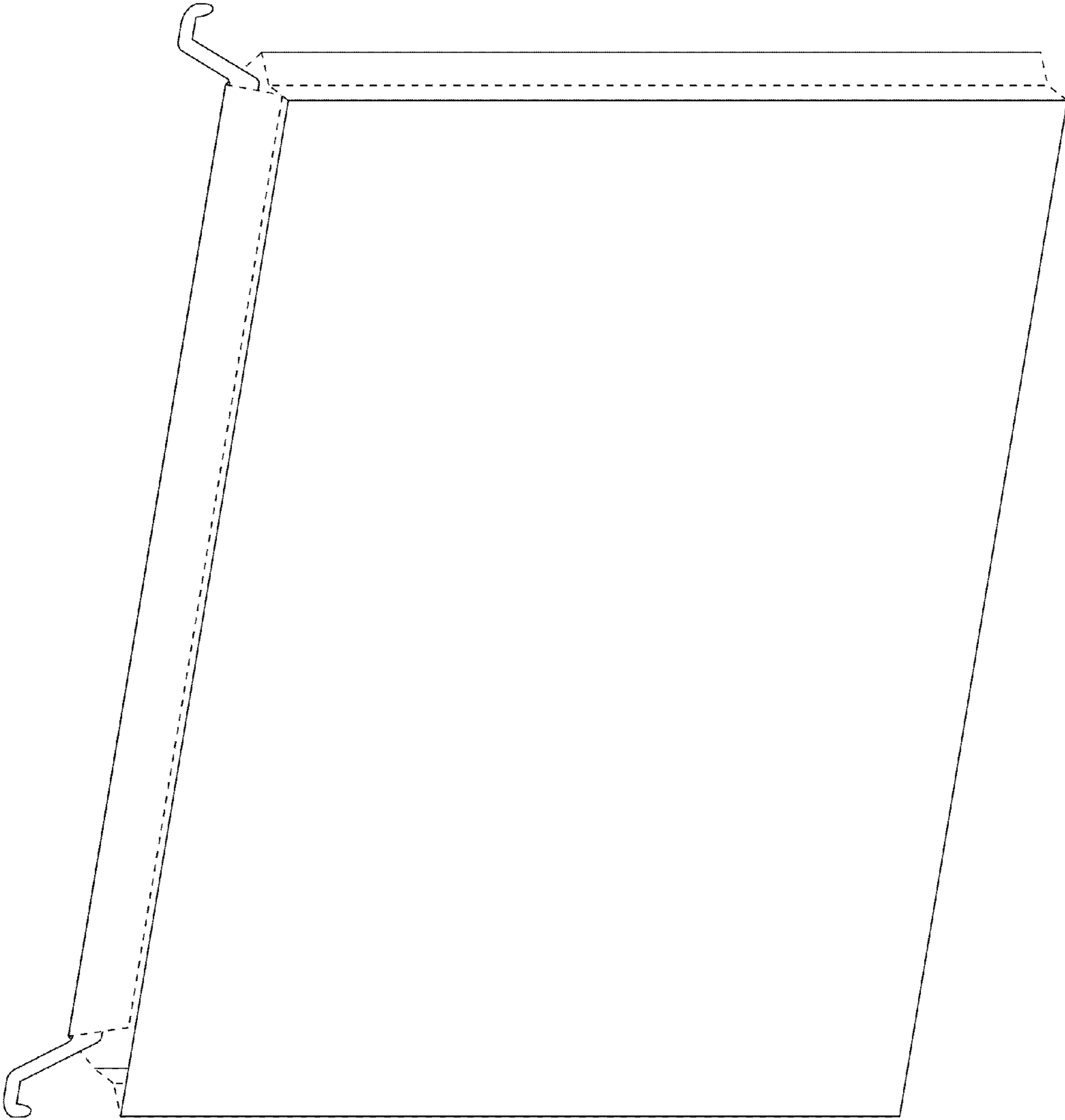

Fig. 9

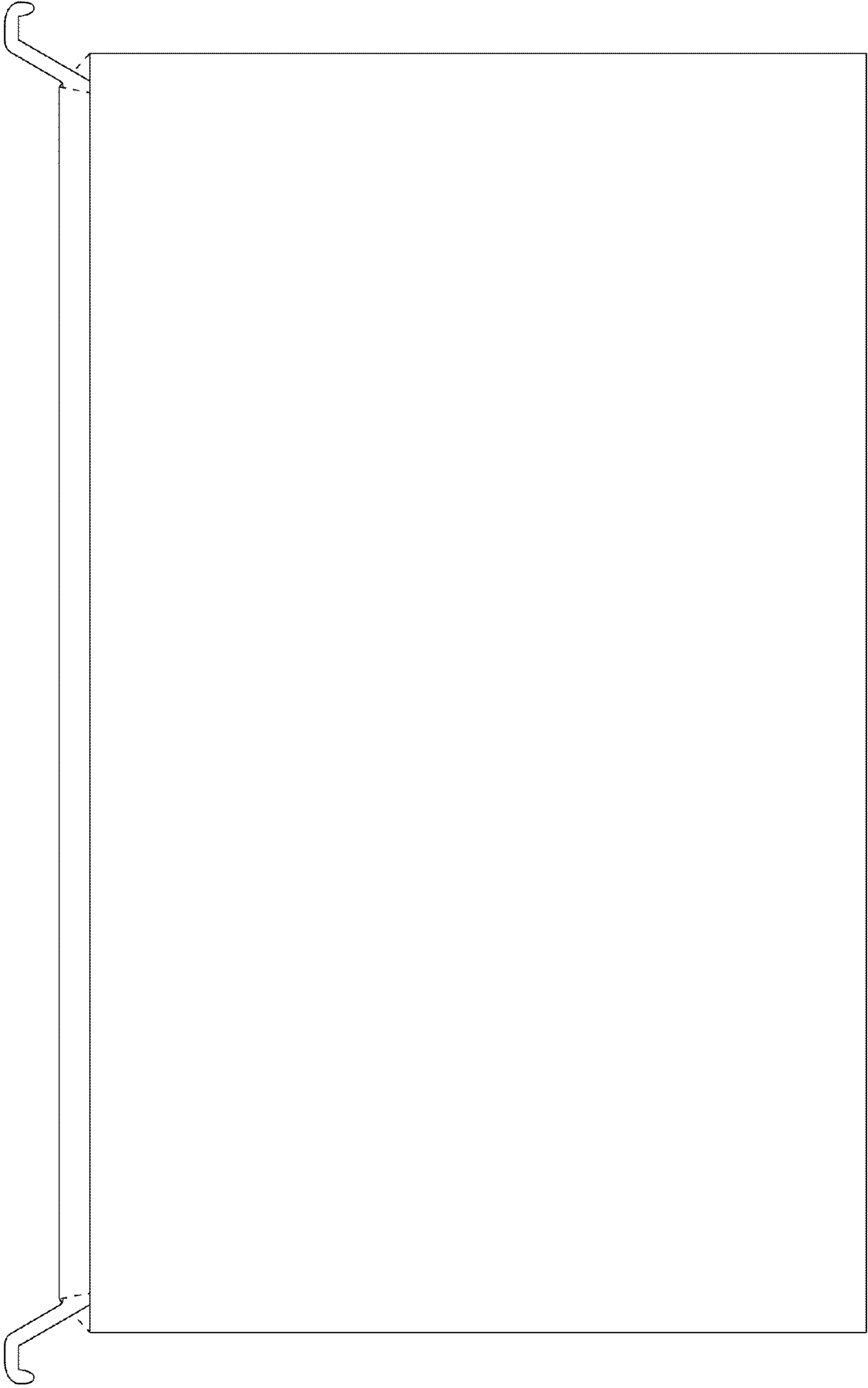

Fig. 10

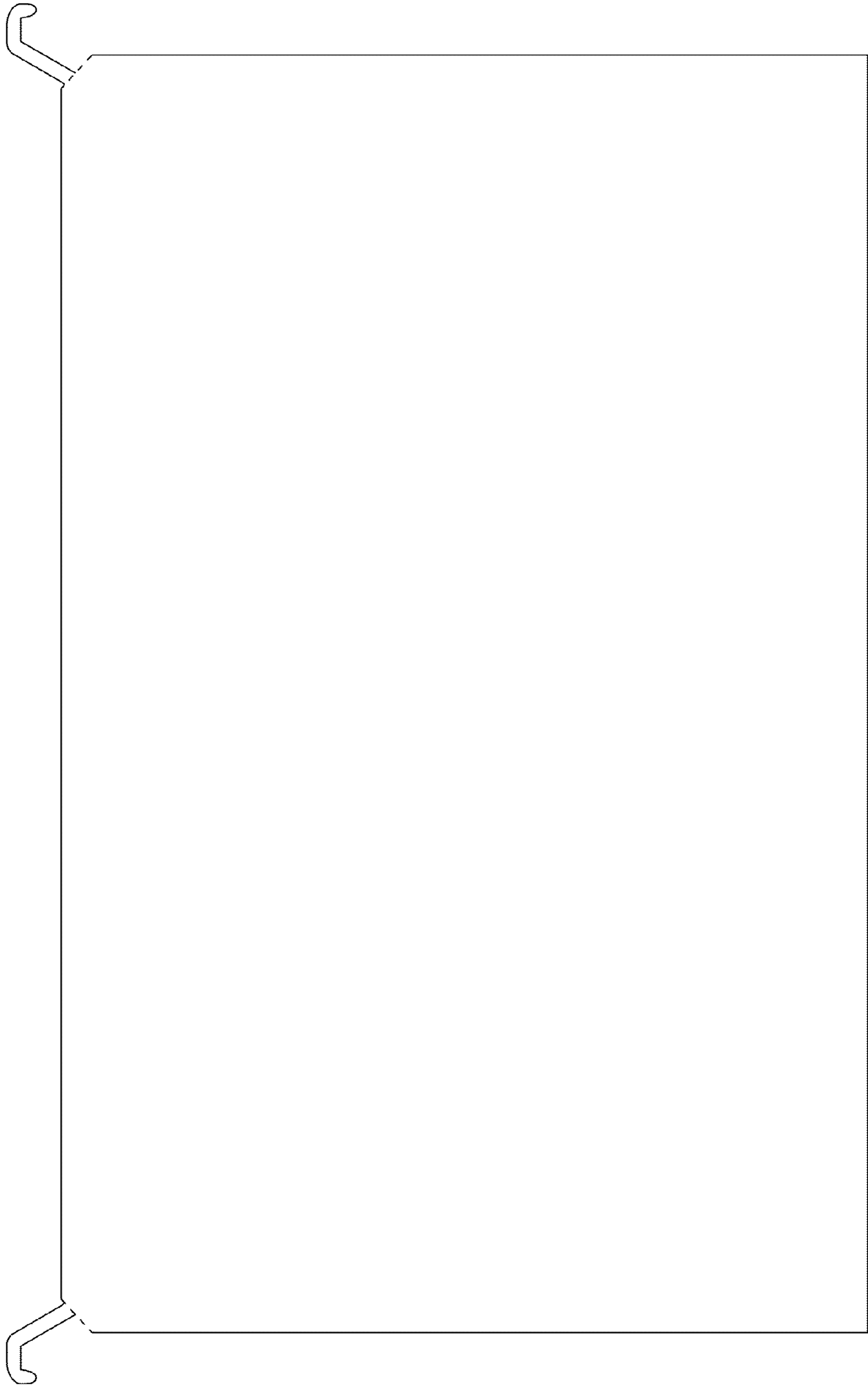

Fig. 11

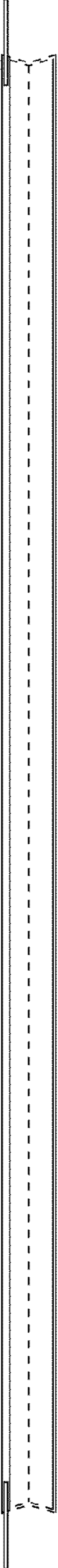

Fig. 12



Fig. 13



Fig. 14



Fig. 15

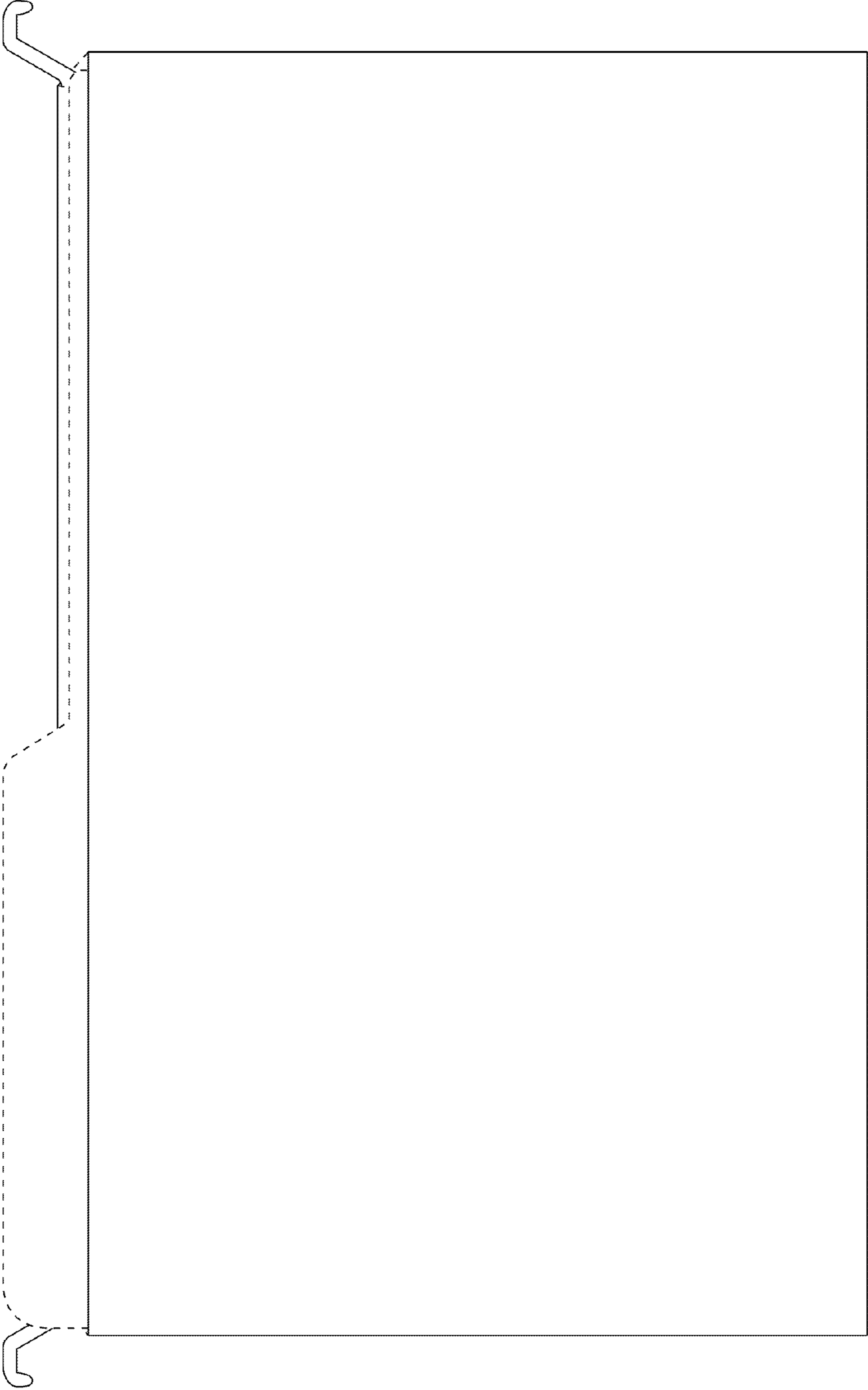

Fig. 16

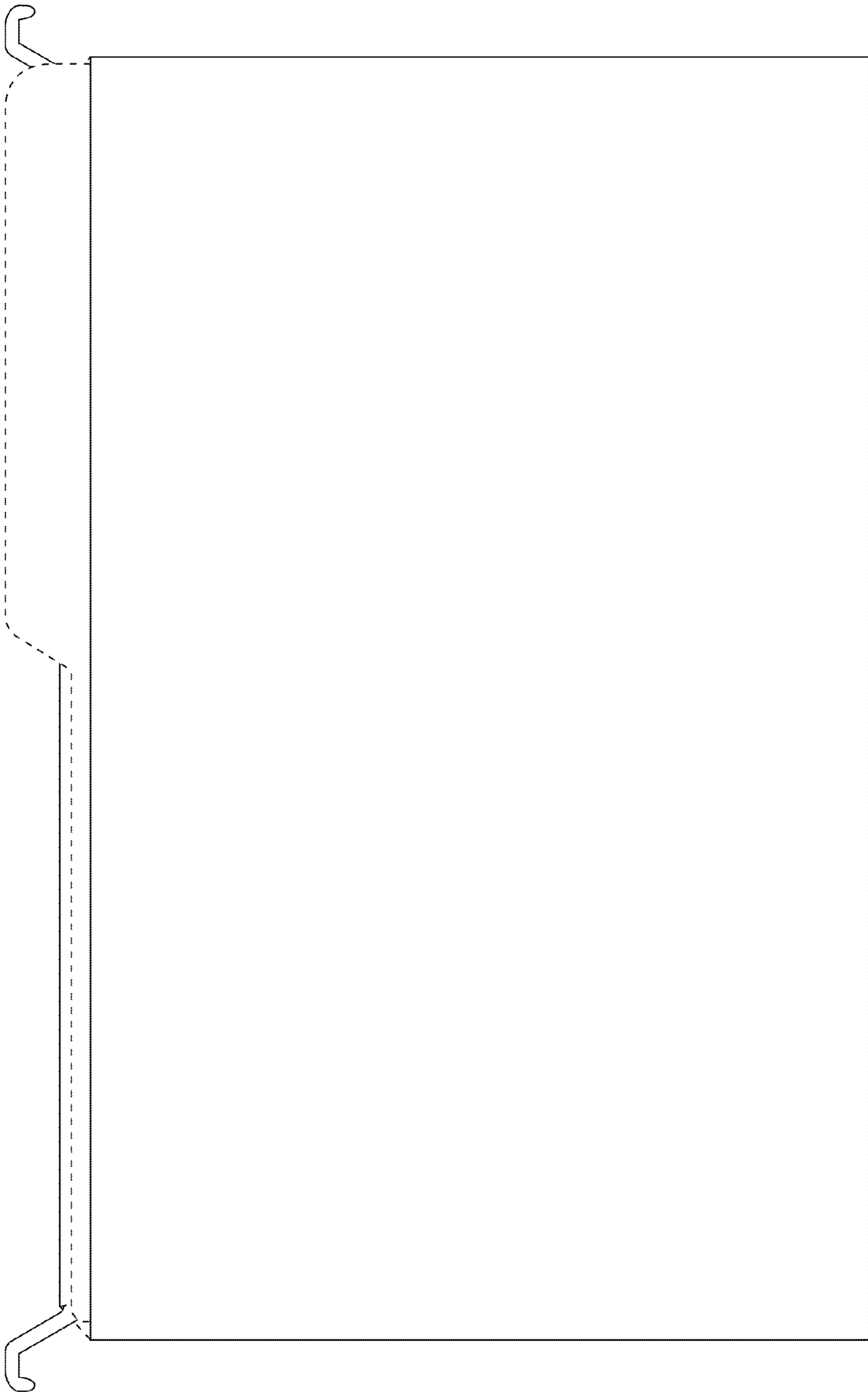

Fig. 17

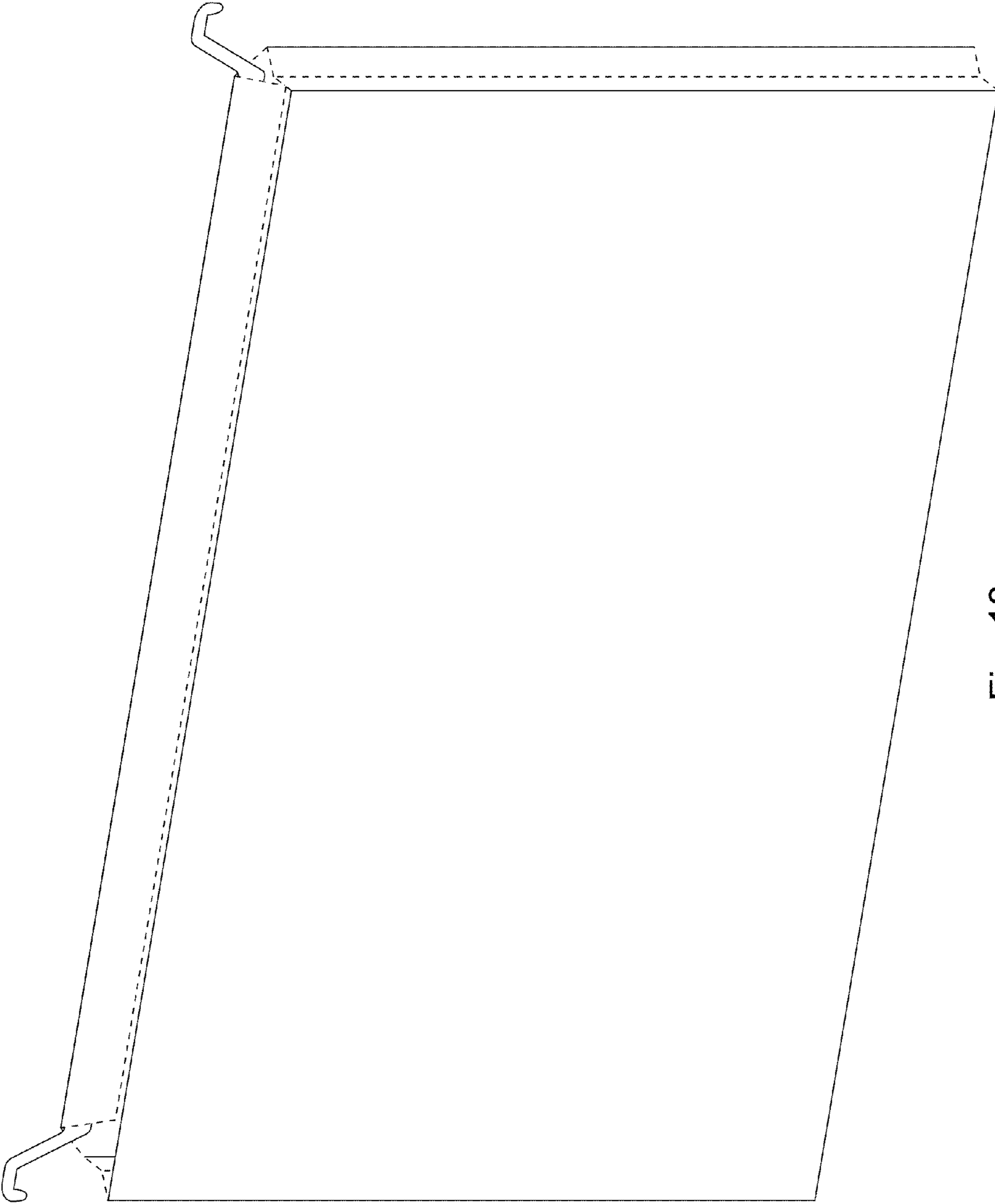

Fig. 18

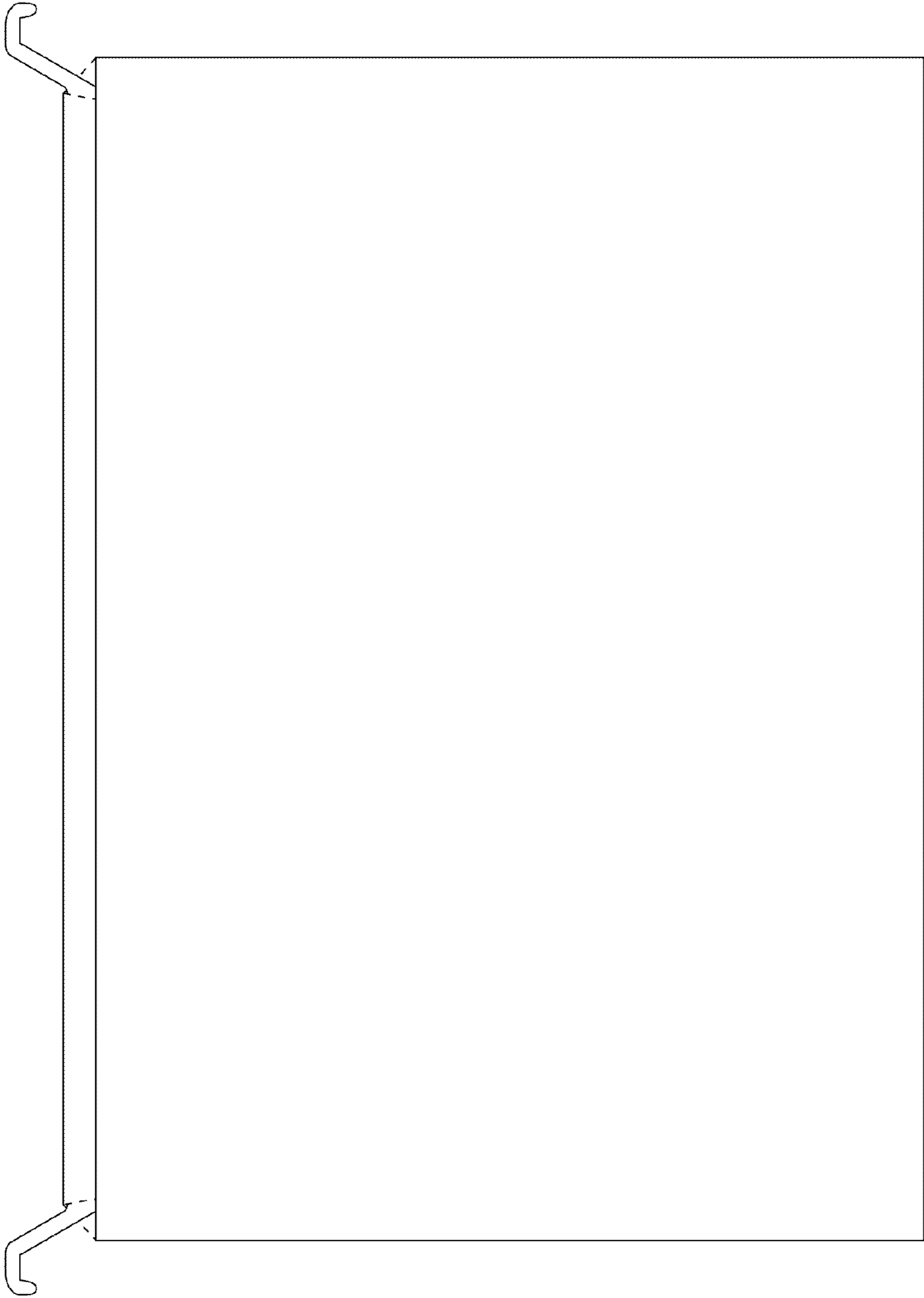

Fig. 19



Fig. 20

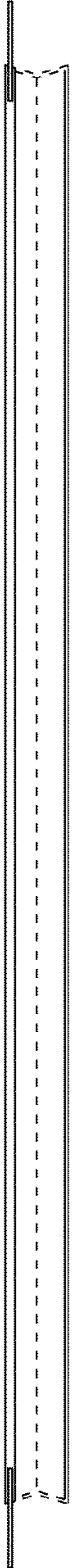

Fig. 21

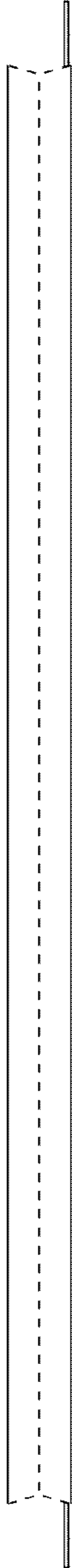

Fig. 22



Fig. 23

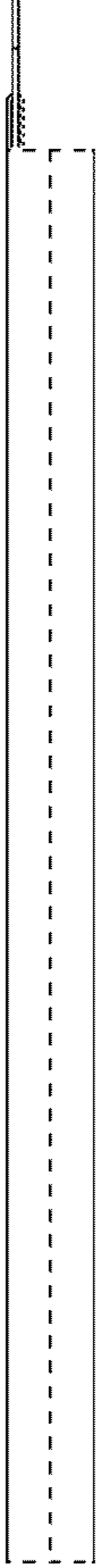

Fig. 24

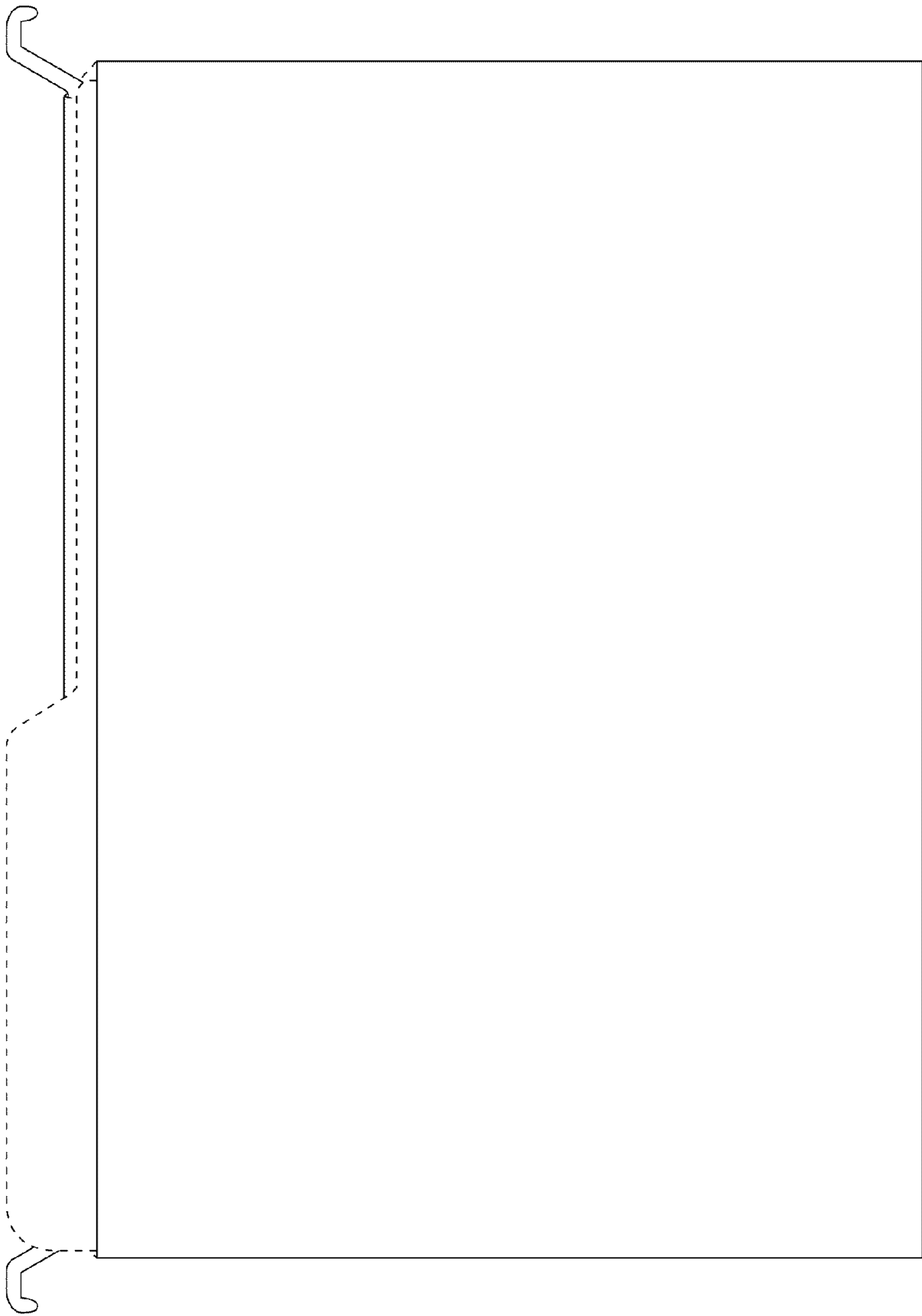

Fig. 25

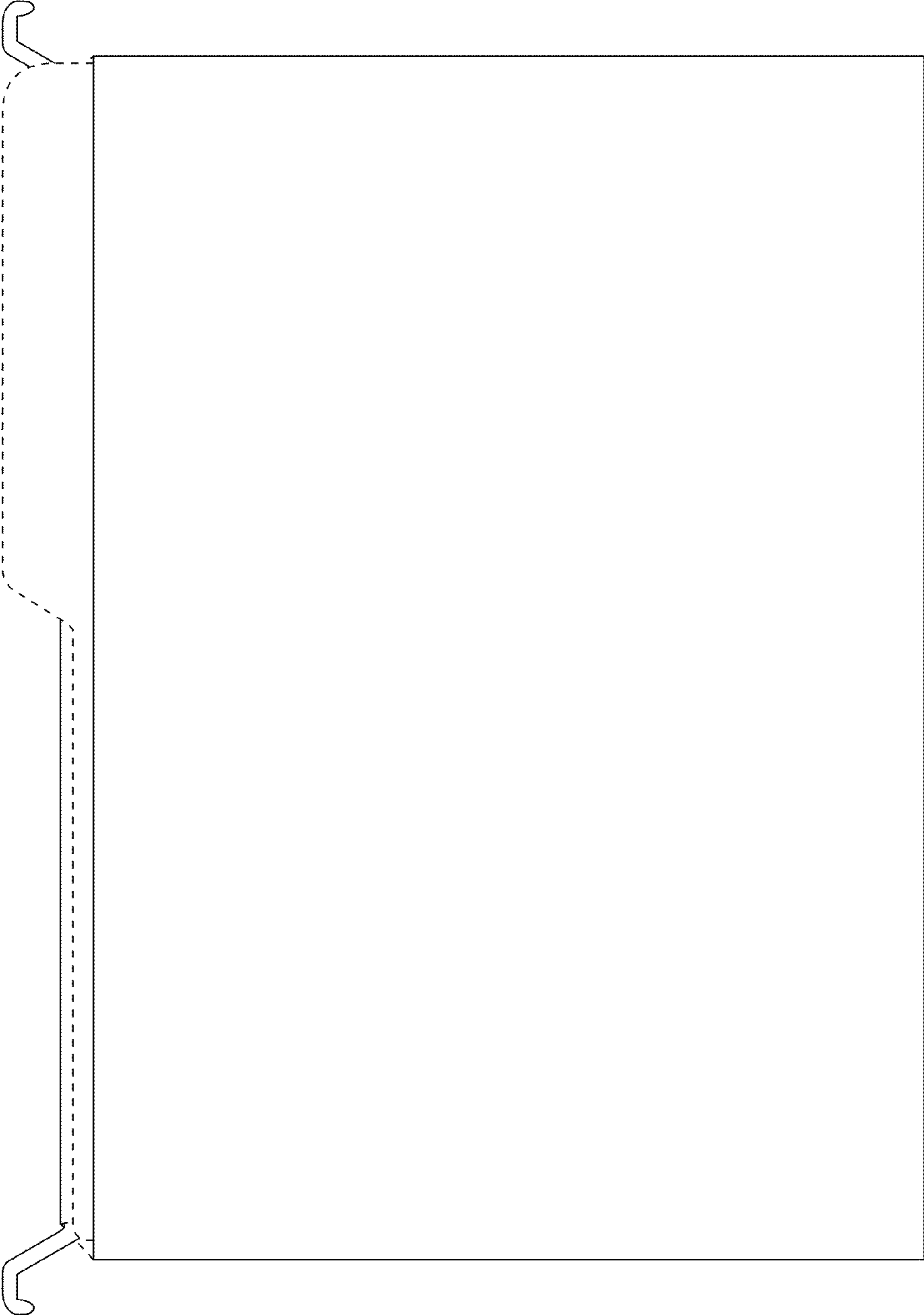

Fig. 26

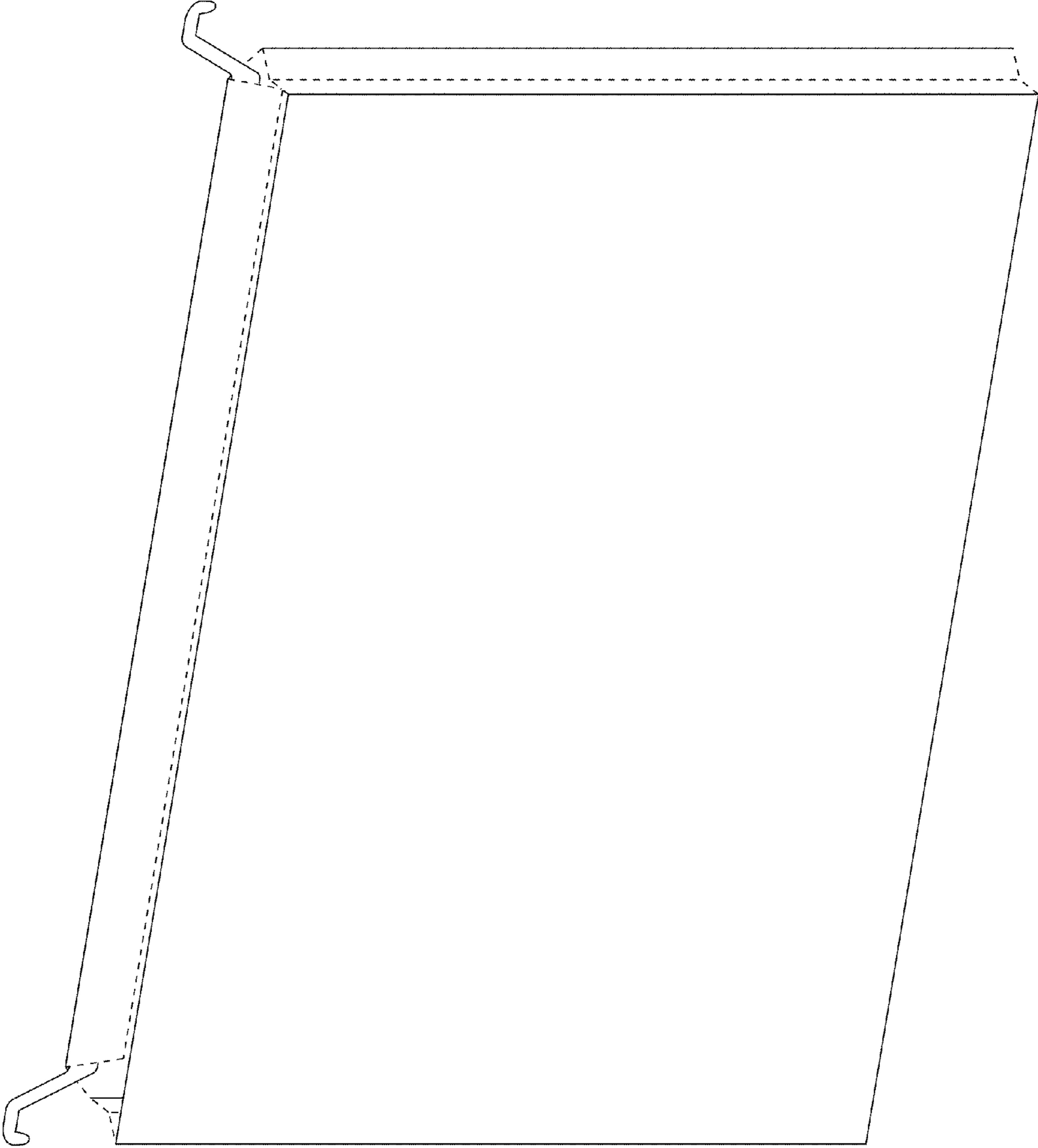

Fig. 27

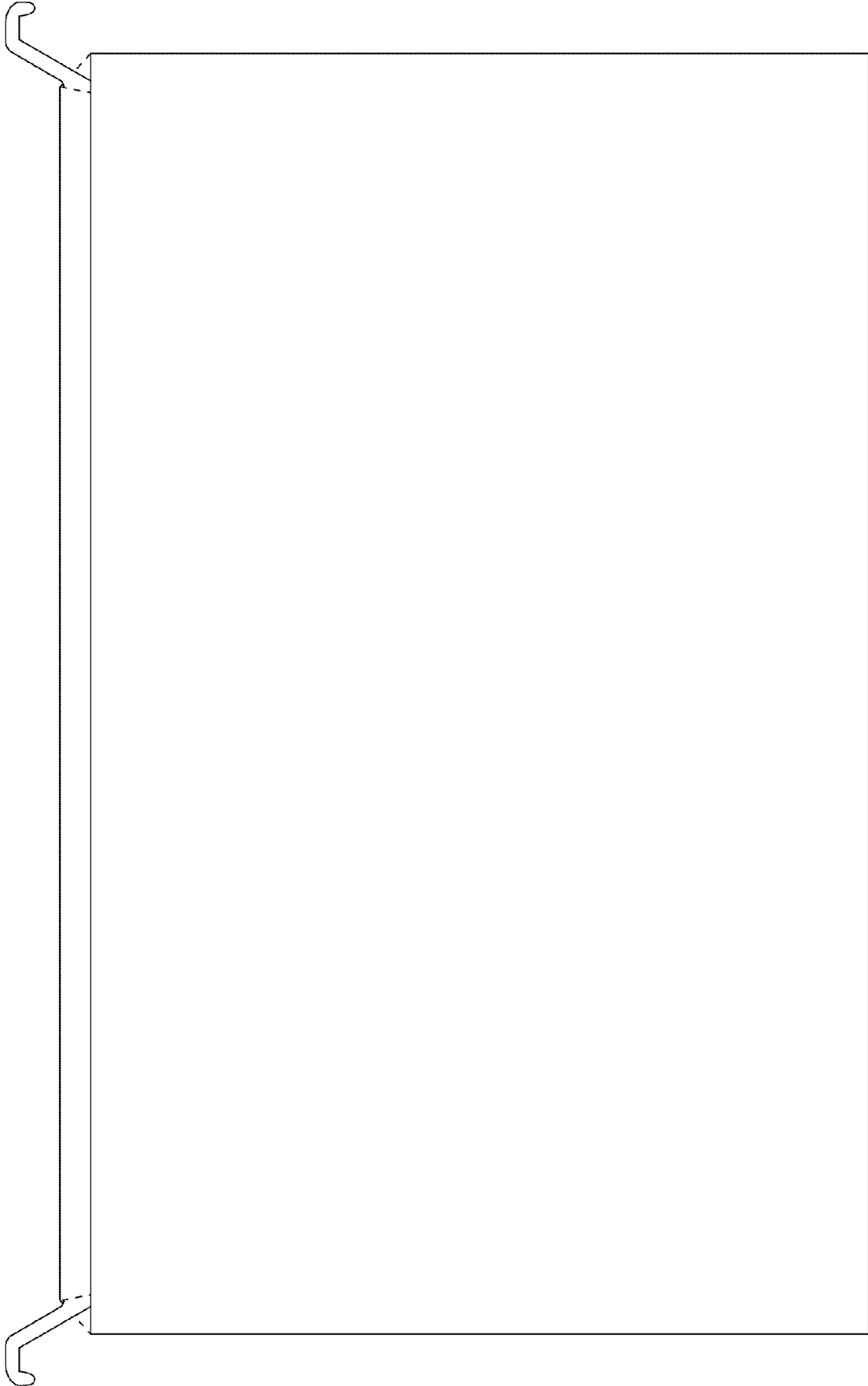

Fig. 28

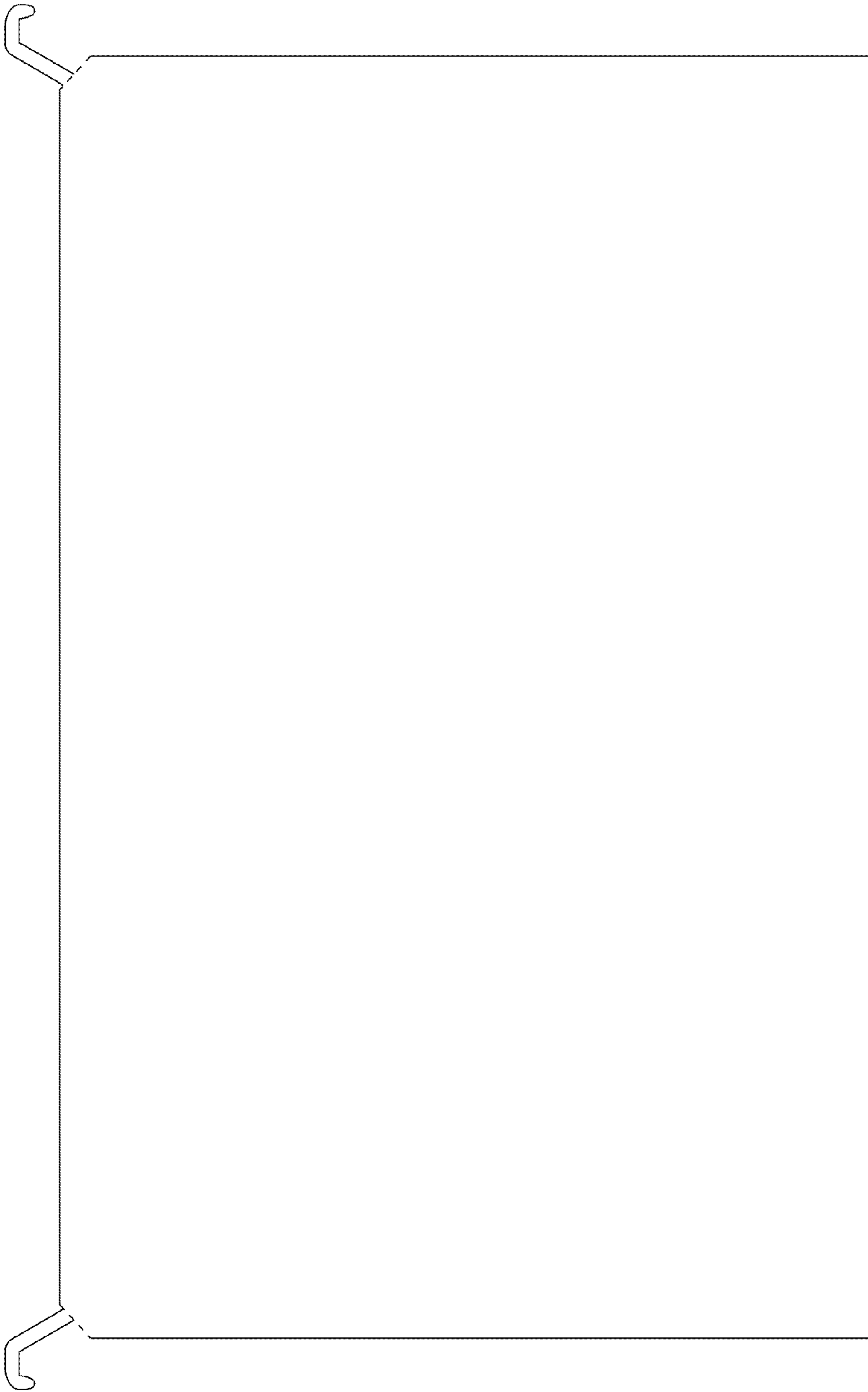

Fig. 29

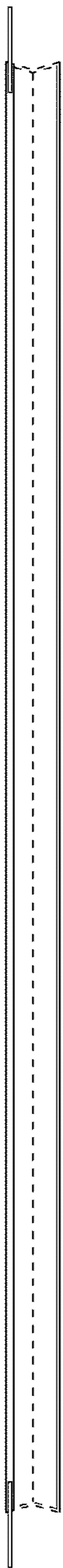

Fig. 30

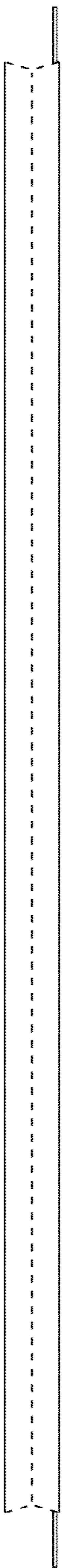

Fig. 31

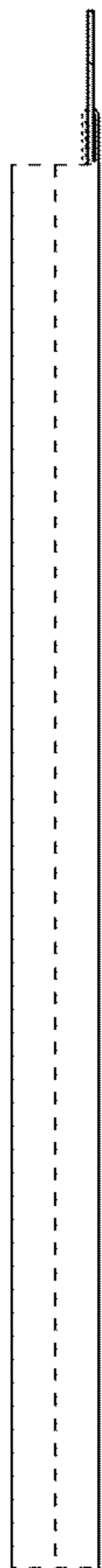

Fig. 32

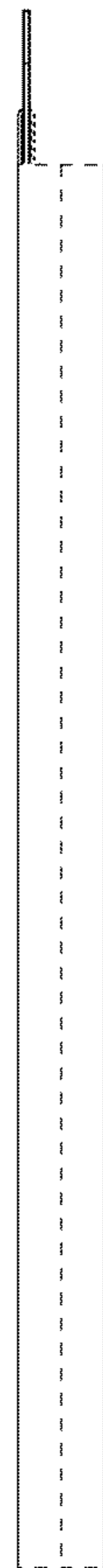

Fig. 33

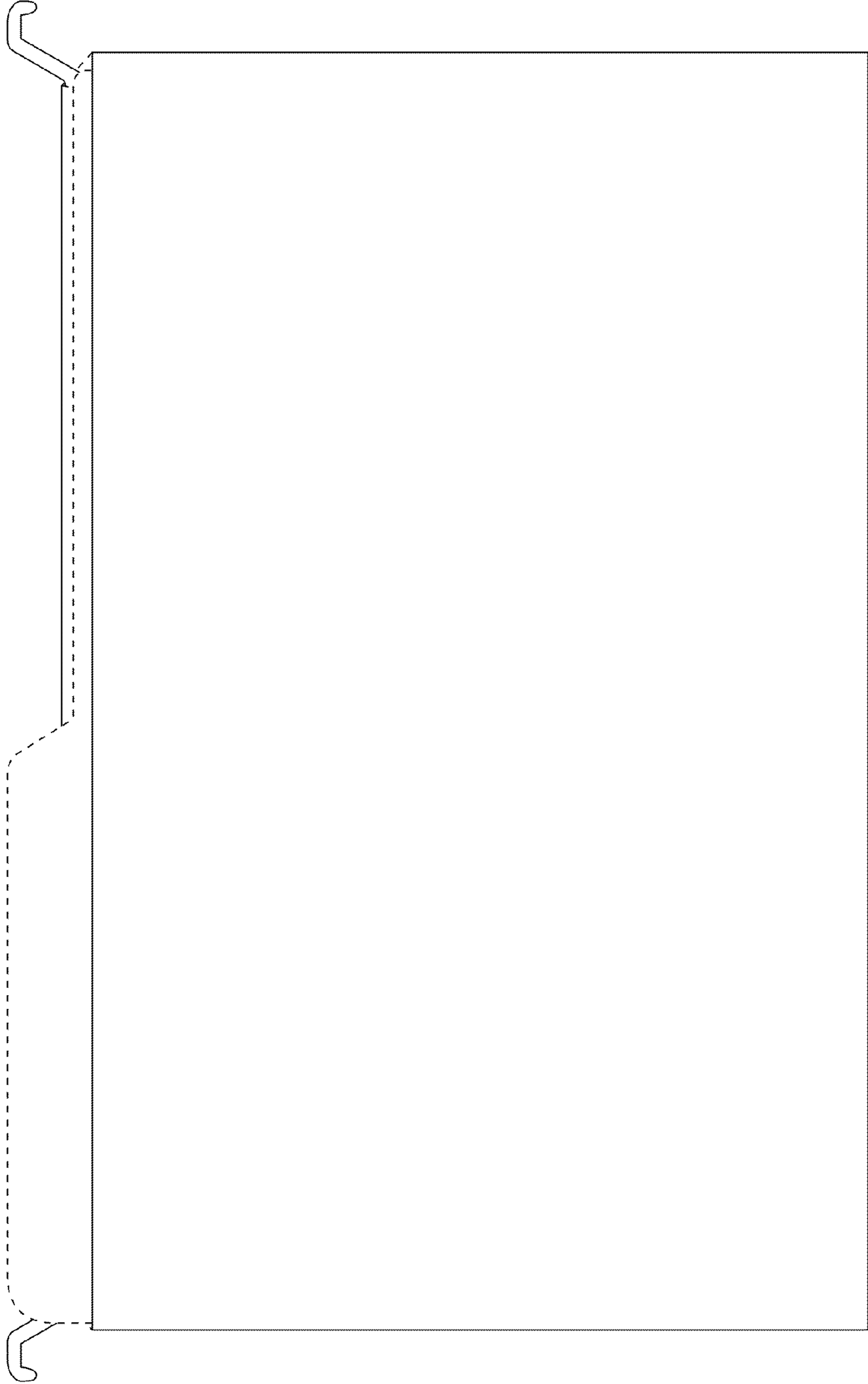

Fig. 34

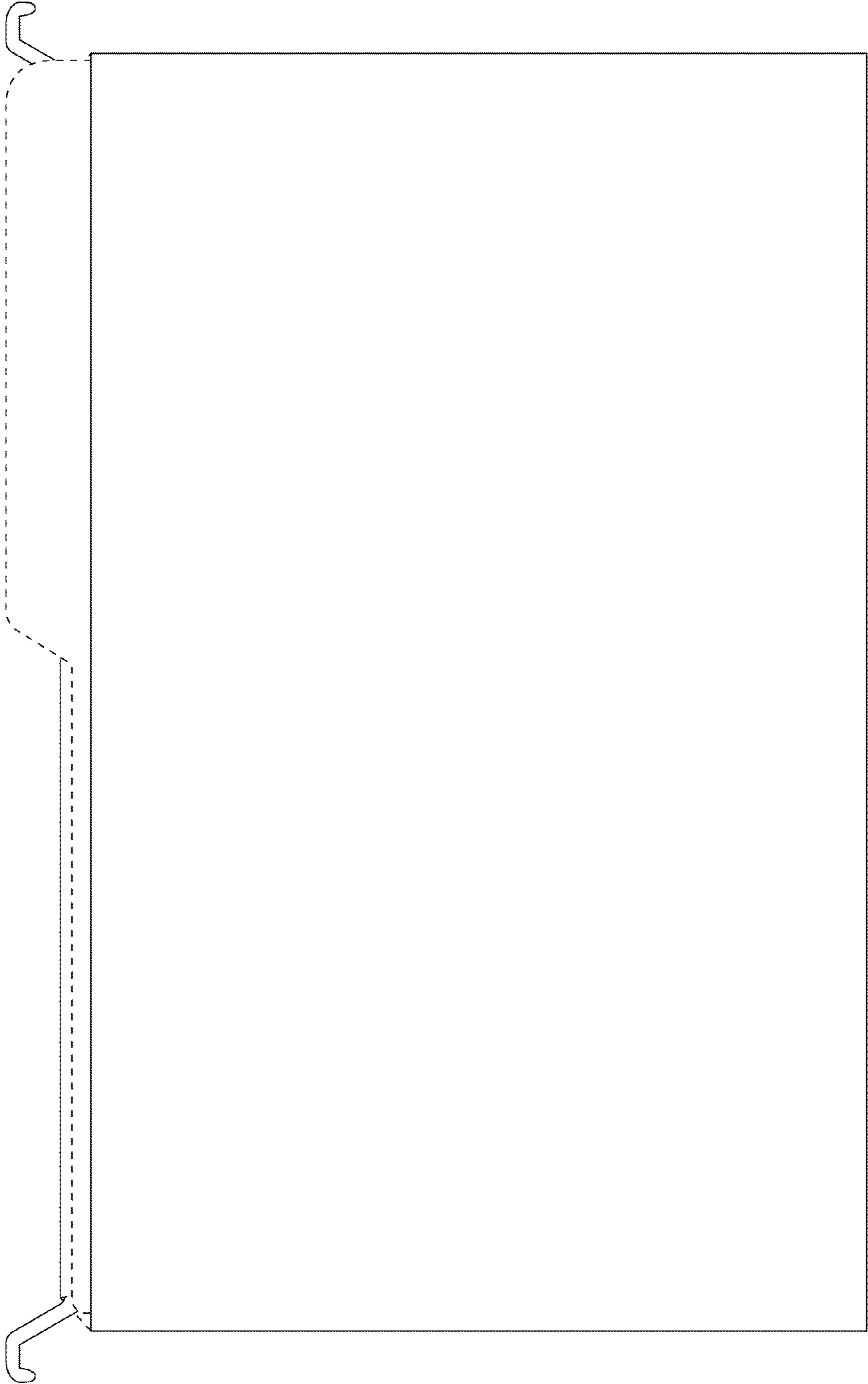

Fig. 35

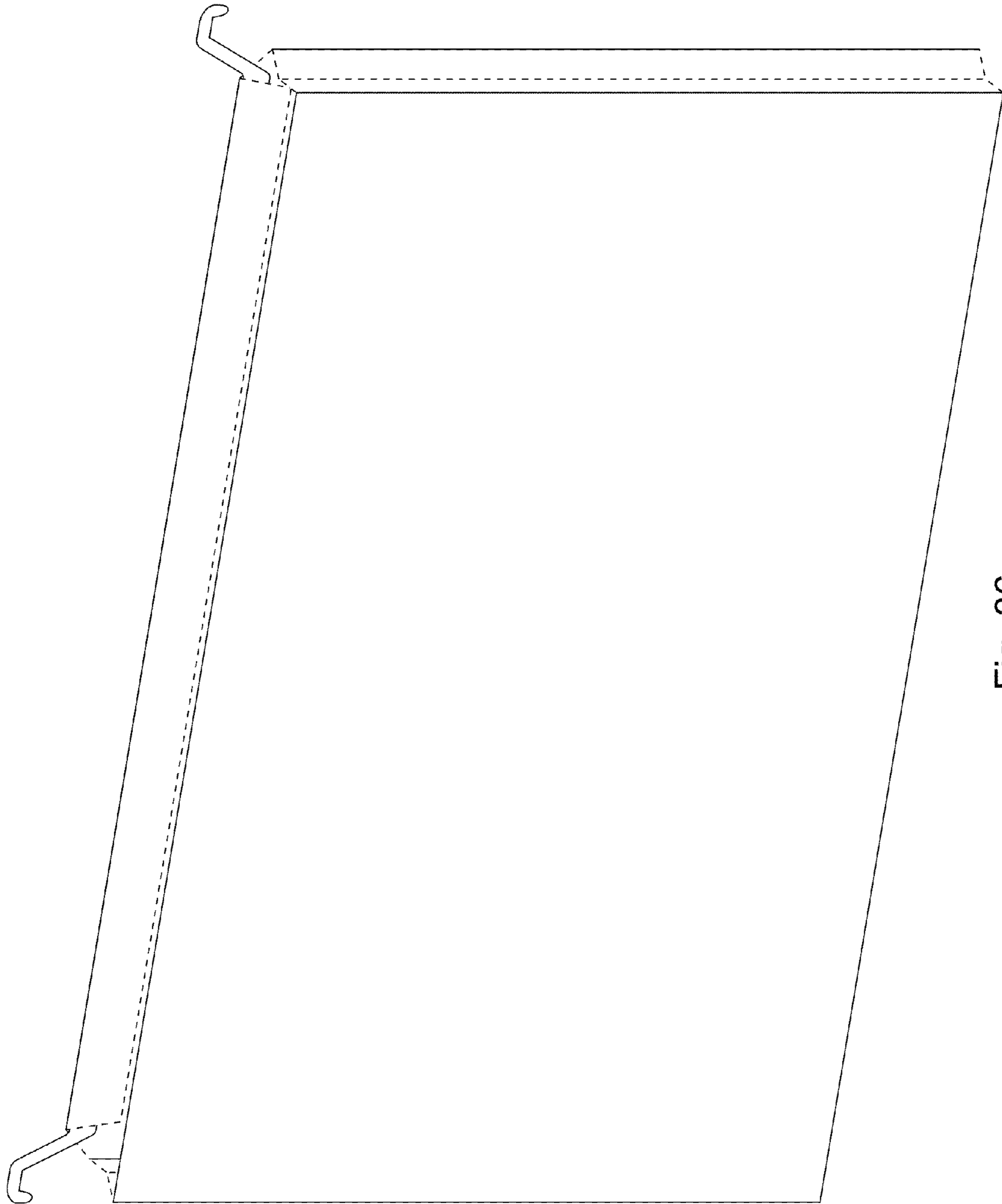

Fig. 36