



US00D759004S

(12) **United States Design Patent**
Stevinson

(10) **Patent No.:** **US D759,004 S**
(45) **Date of Patent:** **** Jun. 14, 2016**

- (54) **COMBO EARPHONE CASE**
- (71) Applicant: **Dean Stevenson**, Centennial, CO (US)
- (72) Inventor: **Dean Stevenson**, Centennial, CO (US)
- (**) Term: **14 Years**
- (21) Appl. No.: **29/517,841**
- (22) Filed: **Feb. 17, 2015**

D221,511 S 8/1971 Dufault
 3,736,925 A 6/1973 Erman
 3,785,080 A 1/1974 Wallace
 D235,850 S 7/1975 Diforte, Jr. et al.
 3,953,911 A 5/1976 Fishack

(Continued)

FOREIGN PATENT DOCUMENTS

WO WO 2012/177285 12/2012
 WO WO 2014/124445 8/2014

OTHER PUBLICATIONS

U.S. Appl. No. 13/167,662 Office Action mailed Jan. 15, 2015, 9 pgs.

(Continued)

Primary Examiner — Barbara Fox
Assistant Examiner — Lilyana Bekic
 (74) *Attorney, Agent, or Firm* — Lathrop & Gage LLP

Related U.S. Application Data

- (62) Division of application No. 29/445,399, filed on Feb. 11, 2013, now Pat. No. Des. 723,532.
- (51) **LOC (10) Cl.** **14-03**
- (52) **U.S. Cl.**
USPC **D14/250**
- (58) **Field of Classification Search**
USPC D14/250, 217, 238.1, 248, 251–253,
D14/440; D3/201, 218, 247, 269, 273, 301,
D3/303
CPC H04B 1/3888; A45C 11/00; A45C
2011/001; A45C 2011/002; A45C 2011/003;
H04M 1/185; H04M 1/0283
See application file for complete search history.

(57) **CLAIM**
 The ornamental design for a combo earphone case, as shown and described.

DESCRIPTION

FIG. 1 is a first front side perspective view of a combo earphone case showing the new design, with the door in a closed position;
 FIG. 2 is a second front side perspective view of the combo earphone case, with the door in an open position;
 FIG. 3 is a top plan view of FIG. 1;
 FIG. 4 is a bottom plan view of FIG. 1;
 FIG. 5 is a left side elevation view of FIG. 1;
 FIG. 6 is a right side elevation view of FIG. 1;
 FIG. 7 is a front elevation view of FIG. 1;
 FIG. 8 is a rear elevation view of FIG. 1; and,
 FIG. 9 is a backside perspective view of FIG. 1.

1 Claim, 7 Drawing Sheets

(56) **References Cited**

U.S. PATENT DOCUMENTS

363,495 A	5/1887	Wilson, Jr.
D22,417 S	5/1893	Scheuer
1,426,537 A	8/1922	Bauer
2,287,368 A	6/1942	Anderson
D136,783 S	12/1943	Veck
2,396,906 A	3/1946	Windson
2,981,990 A	5/1961	Balderree, Jr.
3,161,723 A	12/1964	Flower et al.
D209,330 S	11/1967	Coderre et al.
3,353,232 A	11/1967	Brownson
3,465,391 A	9/1969	Armstrong

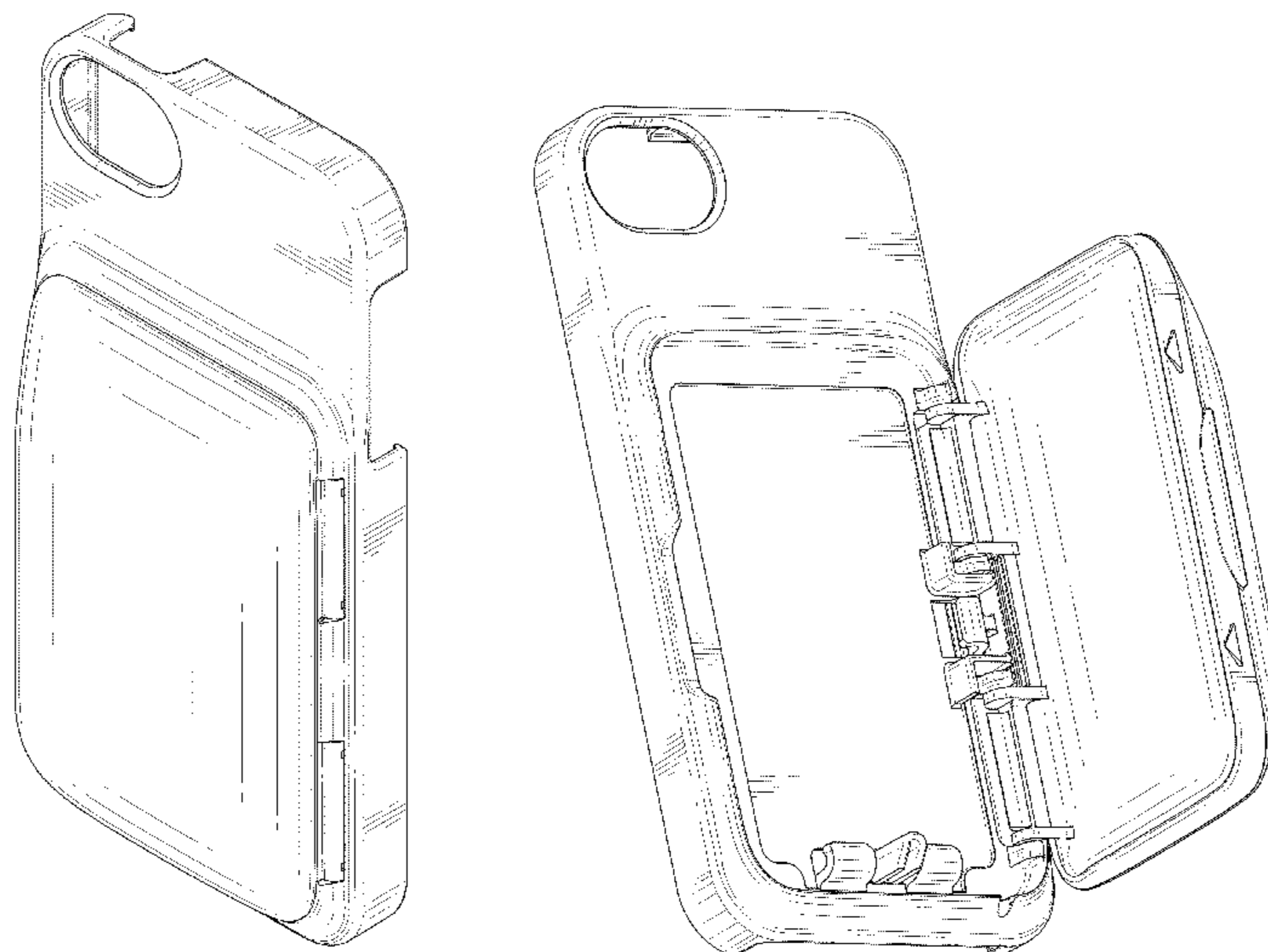

(56)

References Cited

U.S. PATENT DOCUMENTS

4,270,247 A 6/1981 Freedom
D284,299 S 6/1986 Auerbach et al.
4,680,886 A 7/1987 Caselli, Sr.
D347,989 S 6/1994 De Ward
5,383,091 A 1/1995 Snell
5,867,355 A 2/1999 Arai et al.
5,984,224 A 11/1999 Yang
6,006,915 A 12/1999 Moor
6,254,114 B1 7/2001 Pulling et al.
6,370,401 B1 4/2002 Baranowski et al.
6,434,249 B1 8/2002 Wei
6,542,757 B2 4/2003 Bae
6,601,808 B1 8/2003 Nagel
6,633,770 B1 10/2003 Gitzinger et al.
D485,834 S 1/2004 Davetas
D488,460 S 4/2004 Alwicker et al.
6,847,724 B1 1/2005 Weng et al.
D502,388 S 3/2005 Cortez et al.
D508,605 S 8/2005 Hwang et al.
6,928,704 B2 8/2005 Johnson
D514,923 S 2/2006 Brown
D519,275 S 4/2006 Shertzer
7,086,512 B2 8/2006 Shack et al.
D529,288 S 10/2006 Ham
D553,352 S 10/2007 Allen
D556,020 S 11/2007 Whitney
D565,290 S 4/2008 Brandenburg et al.
D576,785 S 9/2008 TerMeer
D576,867 S 9/2008 Kretz
D582,405 S 12/2008 Andre et al.
7,492,917 B2 2/2009 Ito
7,500,644 B2 3/2009 Naudet et al.
D592,399 S 5/2009 Sage
D593,062 S 5/2009 Lee et al.
D596,480 S 7/2009 Murphy
D600,673 S 9/2009 Kim et al.
D601,879 S 10/2009 Kim et al.
D601,992 S 10/2009 Choi et al.
D603,376 S 11/2009 Blasko
D604,501 S 11/2009 Lee
D606,529 S 12/2009 Ferrari et al.
7,669,829 B2 3/2010 Ogatsu
D615,078 S 5/2010 Bradley
D620,781 S 8/2010 Weckworth
D621,393 S 8/2010 Panahi et al.
D623,642 S 9/2010 Wang
D624,064 S 9/2010 Esposito
D624,304 S 9/2010 Danze et al.
7,801,322 B2 9/2010 Chiu
D626,129 S 10/2010 Lutz
D634,115 S 3/2011 Long, Jr. et al.
D635,555 S 4/2011 Giles
D638,398 S 5/2011 Morison
D641,974 S 7/2011 Stampfli
D643,433 S 8/2011 Hsieh et al.
D644,428 S 9/2011 Feng
D644,639 S 9/2011 Weller et al.
D645,032 S 9/2011 Fathollahi
8,016,107 B2 9/2011 Emsky
D647,892 S 11/2011 Ragde, Jr.
D651,791 S 1/2012 Cataldo et al.
D653,656 S 2/2012 Charnas et al.
D654,931 S 2/2012 Lemelman et al.
D657,137 S 4/2012 Weller et al.
D661,482 S 6/2012 Chang et al.
D667,823 S 9/2012 Merenda
D667,910 S 9/2012 Behr
D673,936 S 1/2013 Michie et al.
D673,940 S 1/2013 Chang et al.
D673,941 S 1/2013 Melanson et al.
8,345,913 B2 1/2013 Pang et al.
D676,021 S 2/2013 Stevinson
D676,022 S 2/2013 Stevinson
D676,416 S 2/2013 Stevinson
D681,026 S 4/2013 Weller et al.

D682,807 S 5/2013 Stevinson
D683,955 S 6/2013 Melanson et al.
D685,344 S 7/2013 Mercs
8,485,404 B2* 7/2013 Monaco A45C 11/00
206/320
D688,234 S 8/2013 Esses
D688,654 S 8/2013 Stevinson
D688,655 S 8/2013 Rey-Hipolito et al.
D689,303 S 9/2013 Davison
D691,581 S 10/2013 Mercs et al.
8,579,172 B2 11/2013 Monaco et al.
D698,772 S 2/2014 Merenda
D703,650 S 4/2014 Ehrlich
D703,651 S 4/2014 Ehrlich
D704,181 S 5/2014 Stevinson
D705,199 S 5/2014 Huang et al.
D705,764 S 5/2014 Thoni
8,720,683 B2 5/2014 Mao
8,774,446 B2 7/2014 Merenda
8,783,531 B2 7/2014 Kroupa
8,787,610 B2 7/2014 Stevinson
D710,346 S 8/2014 Smith et al.
8,800,907 B2* 8/2014 Koenig H04R 1/1033
191/12.4
8,842,872 B2 9/2014 Stevinson
D720,330 S 12/2014 Stevinson
D720,718 S 1/2015 Stevinson
D723,532 S 3/2015 Stevinson
D723,533 S 3/2015 Stevinson
D724,573 S 3/2015 Stevinson
D726,701 S 4/2015 Stevinson
D732,011 S* 6/2015 Stevinson D14/250
9,071,902 B1* 6/2015 Ai H04R 1/1033
D735,706 S* 8/2015 Stevinson D14/250
D744,470 S* 12/2015 Stevinson D14/250
2001/0035242 A1 11/2001 Hughs et al.
2002/0079244 A1 6/2002 Kwong
2003/0096640 A1 5/2003 Bae
2003/0157973 A1 8/2003 Yang
2005/0150796 A1 7/2005 Wong et al.
2006/0287006 A1 12/2006 McIntyre et al.
2007/0154048 A1 7/2007 Chang
2008/0009329 A1 1/2008 Adler
2008/0053851 A1 3/2008 Ko et al.
2008/0080732 A1 4/2008 Sneed
2008/0090626 A1 4/2008 Griffin et al.
2008/0242376 A1 10/2008 Lin et al.
2009/0036175 A1 2/2009 Bradenburg et al.
2009/0242364 A1 10/2009 Prest et al.
2010/0096284 A1 4/2010 Bau
2011/0077061 A1 3/2011 Danze et al.
2011/0130174 A1 6/2011 Kroupa
2011/0170732 A1* 7/2011 Parker H04R 1/1033
381/384
2011/0203954 A1 8/2011 Kroupa
2011/0233078 A1* 9/2011 Monaco A45C 11/00
206/223
2011/0317865 A1 12/2011 Stevinson
2012/0077556 A1 3/2012 McKendrick
2013/0140195 A1 6/2013 Law et al.
2013/0148839 A1 6/2013 Stevinson
2013/0208937 A1 8/2013 Stern et al.
2013/0237290 A1 9/2013 Simmons, Jr. et al.
2014/0079237 A1 3/2014 Cataldo et al.
2014/0083876 A1* 3/2014 Lin A45C 11/00
206/37
2014/0105441 A1 4/2014 Kroupa
2014/0161301 A1* 6/2014 Merenda B65H 75/48
381/384
2014/0251368 A1* 9/2014 Lawson A45C 11/00
132/287
2015/0365756 A1* 12/2015 Merenda H04R 1/1033
381/375

OTHER PUBLICATIONS

U.S. Appl. No. 13/167,662 Response to Office Action filed Dec. 22,
2014, 12 pgs.

(56)

References Cited

OTHER PUBLICATIONS

U.S. Appl. No. 13/167,662, Office Action mailed Sep. 25, 2014, 9 pgs.
U.S. Appl. No. 13/336,918, Notice of Allowance mailed Mar. 14, 2014, 11 pgs.
U.S. Appl. No. 13/336,918, Office Action mailed Sep. 25, 2013, 14 pgs.
U.S. Appl. No. 13/336,918, Response to Office Action filed Dec. 20, 2013, 9 pgs.
U.S. Appl. No. 13/764,666, Notice of Allowance mailed May 16, 2014, 10 pgs.
U.S. Appl. No. 29/409,520, Notice of Allowance mailed Oct. 3, 2012, 8 pgs.
U.S. Appl. No. 29/409,521, Notice of Allowance mailed Sep. 26, 2012, 7 pgs.
U.S. Appl. No. 29/409,525, Ex Parte Quayle Action mailed Sep. 26, 2012, 6 pgs.
U.S. Appl. No. 29/409,525, Notice of Allowance mailed Jan. 9, 2013, 8 pgs.
U.S. Appl. No. 29/409,528, Notice of Allowance mailed Sep. 26, 2012, 8 pgs.
U.S. Appl. No. 29/409,529, Office Action mailed Dec. 4, 2013, 13 pgs.
U.S. Appl. No. 29/409,529, Response to Office Action filed Mar. 3, 2014, 16 pgs.
U.S. Appl. No. 29/409,531, Notice of Allowance mailed Dec. 6, 2013, 11 pgs.
U.S. Appl. No. 29/409,535, Notice of Allowance mailed Apr. 15, 2013, 7 pgs.
U.S. Appl. No. 29/409,547, Office Action mailed Jan. 8, 2013, 7 pgs.
U.S. Appl. No. 29/409,547, Office Action mailed Jul. 23, 2013, 7 pgs.
U.S. Appl. No. 29/409,547, Response to Office Action filed Apr. 8, 2013, 9 pgs.
U.S. Appl. No. 29/445,396, Notice of Allowance dated Mar. 27, 2015, 9 pages.

U.S. Appl. No. 29/445,397, Notice of Allowance mailed Nov. 24, 2014, 10 pgs.
U.S. Appl. No. 29/445,397, Response to Restriction Requirement filed Oct. 27, 2014, 5 pgs.
U.S. Appl. No. 29/445,397, Restriction Requirement mailed Aug. 28, 2014, 7 pgs.
U.S. Appl. No. 29/445,399, Notice of Allowance mailed Oct. 7, 2014, 11 pgs.
U.S. Appl. No. 29/445,400, Notice of Allowance mailed Oct. 10, 2014, 12 pgs.
U.S. Appl. No. 29/445,401, Notice of Allowance mailed Aug. 22, 2014, 8 pgs.
U.S. Appl. No. 29/445,402, Notice of Allowance mailed Aug. 21, 2014, 8 pgs.
U.S. Appl. No. 29/445,403, Notice of Allowance mailed Oct. 22, 2014, 12 pgs.
U.S. Appl. No. 29/445,405 Notice of Allowance, mailed Jan. 16, 2015, 8 pgs.
U.S. Appl. No. 29/445,408 Notice of Allowance, dated Feb. 11, 2015, 8 pages.
U.S. Appl. No. 29/445,408 Response to Office Action, filed Dec. 30, 2014, 7 pgs.
U.S. Appl. No. 29/445,408, Office Action mailed Oct. 3, 2014, 11 pgs.
U.S. Appl. No. 29/453,281, Response to Office Action filed Mar. 23, 2015, 11 pages.
U.S. Appl. No. 29/453,281, Office Action dated Nov. 21, 2014, 11 pgs.
International Search Report corresponding to International Patent Application No. PCT/US2011/067263, mailed Jul. 11, 2012.
European Application No. 11868100.6, Supplementary Search Report dated Nov. 24, 2014, 7 pages.
iHeadCase: Cases with Concealed Headphone Storage Systems accessed on the Internet Oct. 7, 2013 <http://www.kickstarter.com/projects/1695629752/iheadcase-cases-with-concealed-headphone-storage-s>; 13 pages.

* cited by examiner

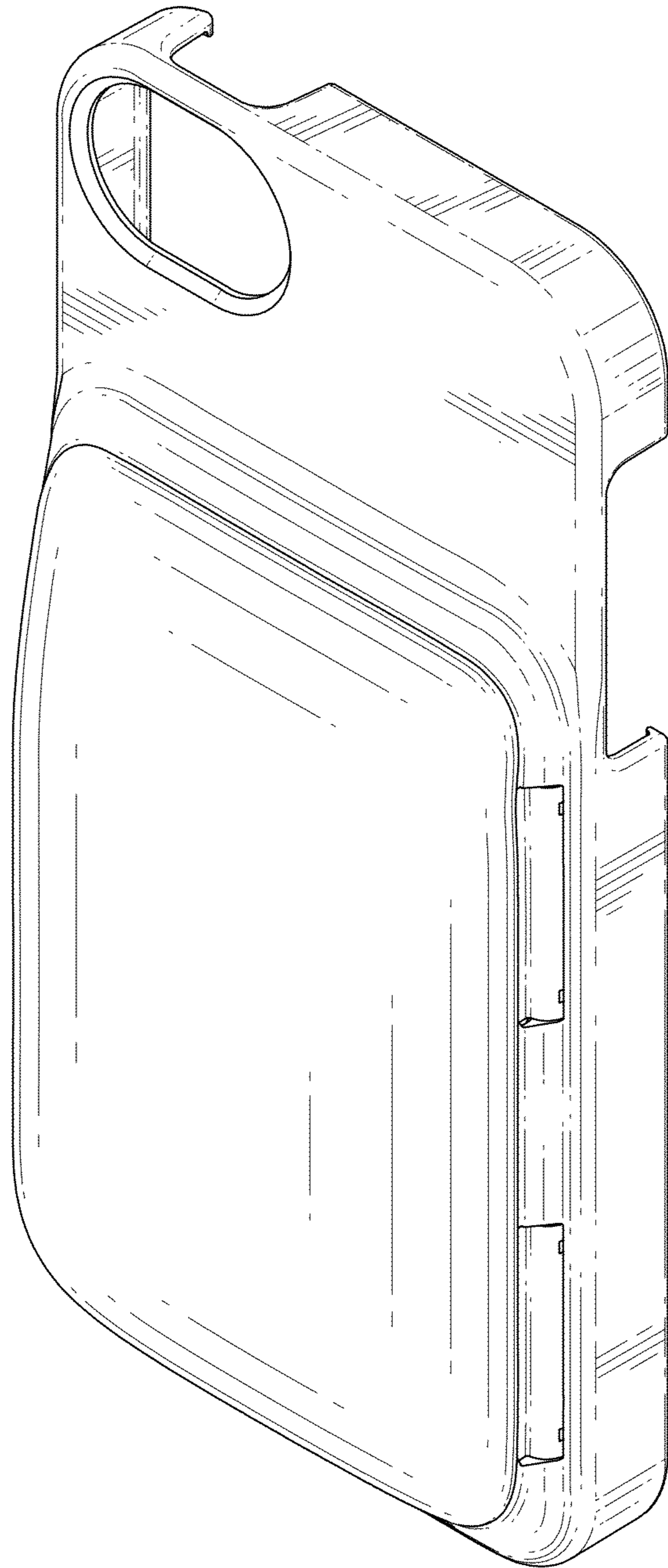

FIG. 1

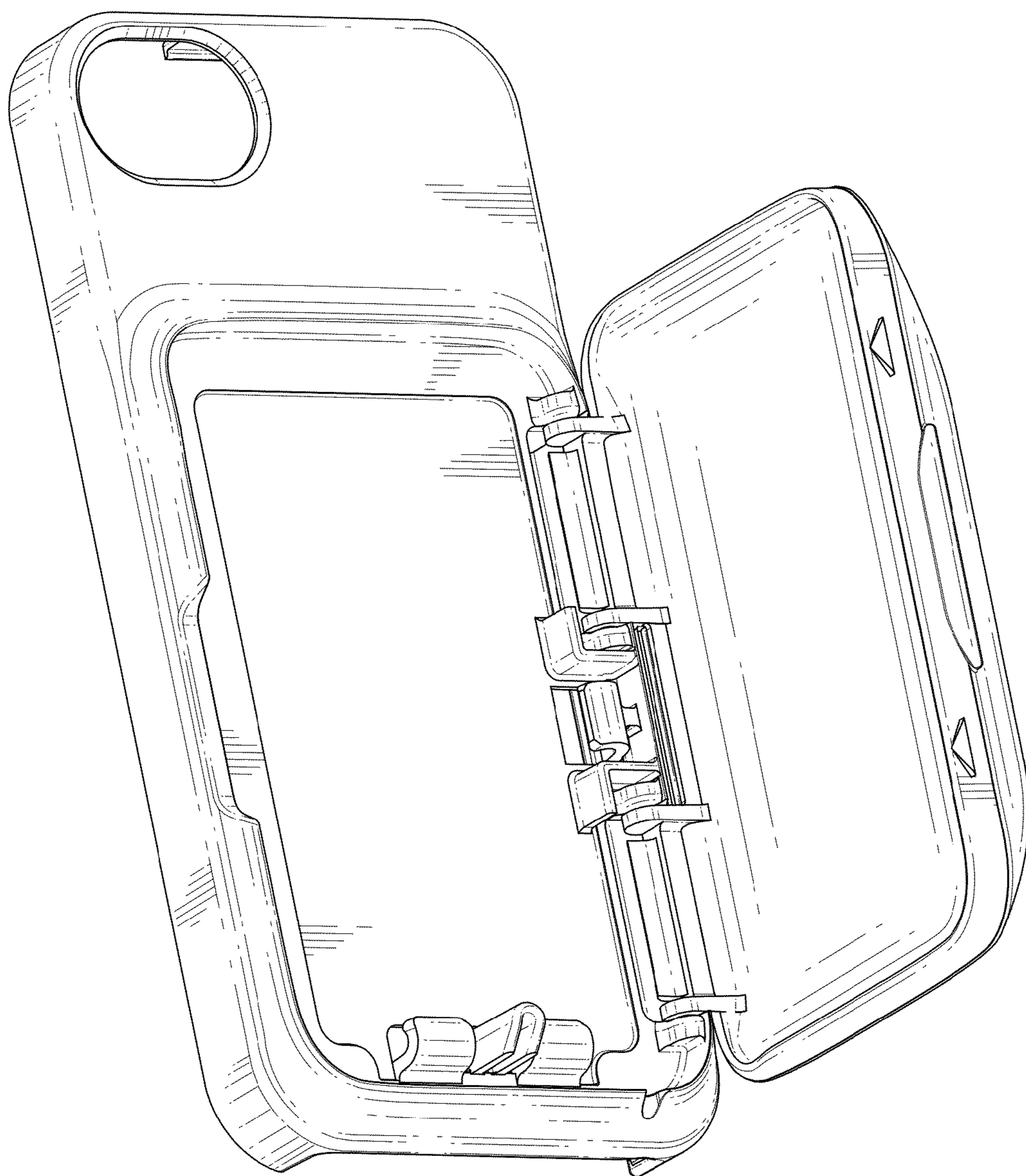

FIG. 2

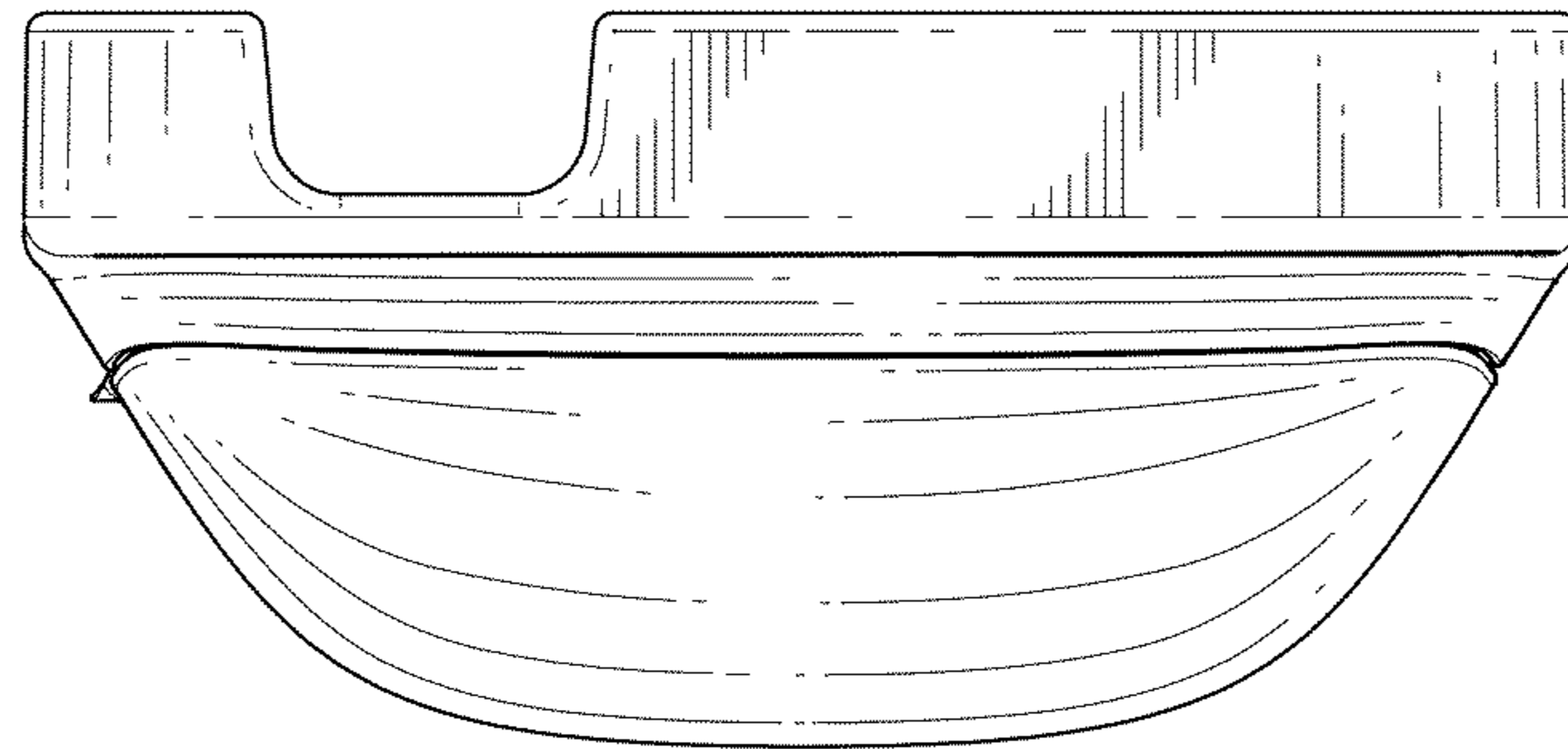

FIG. 3

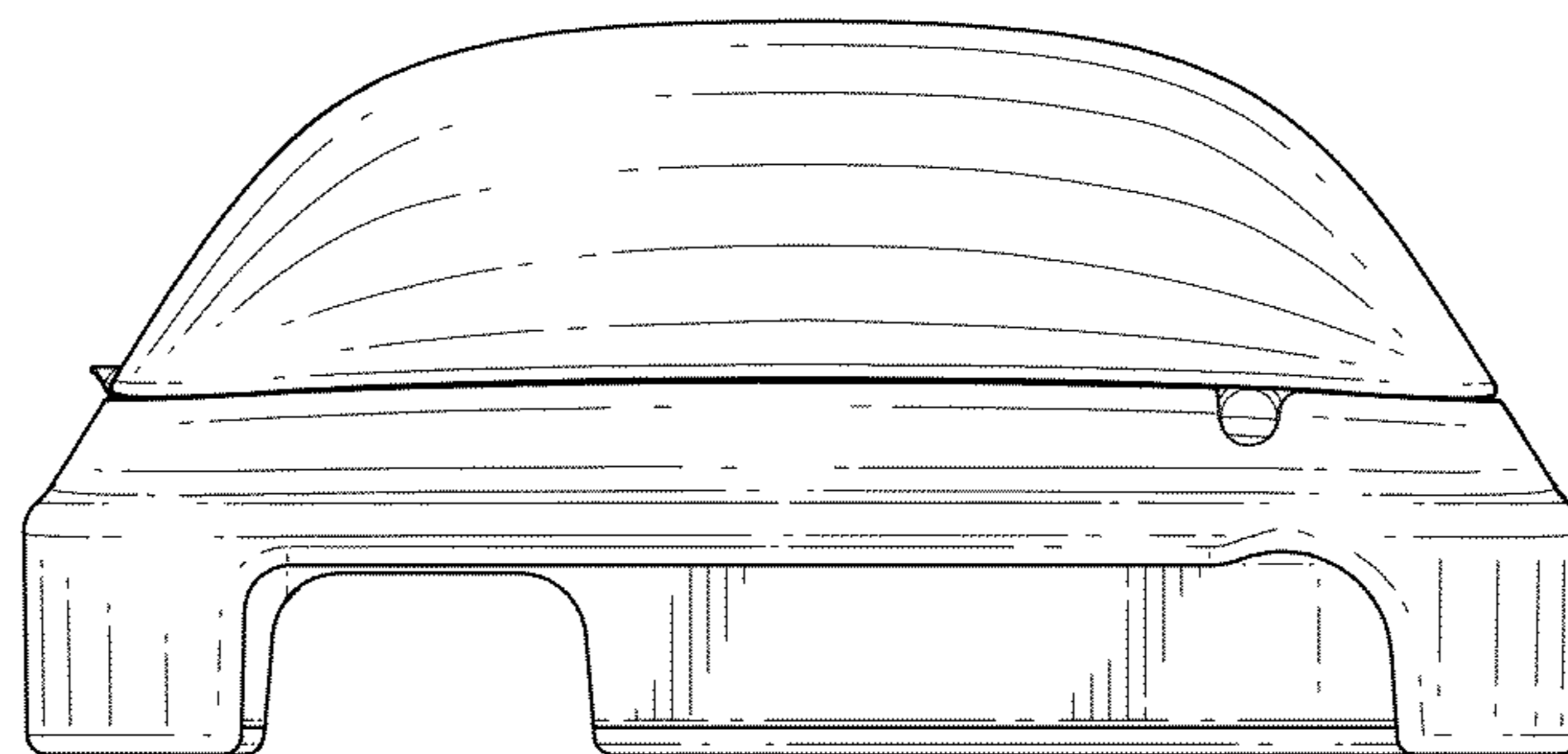

FIG. 4

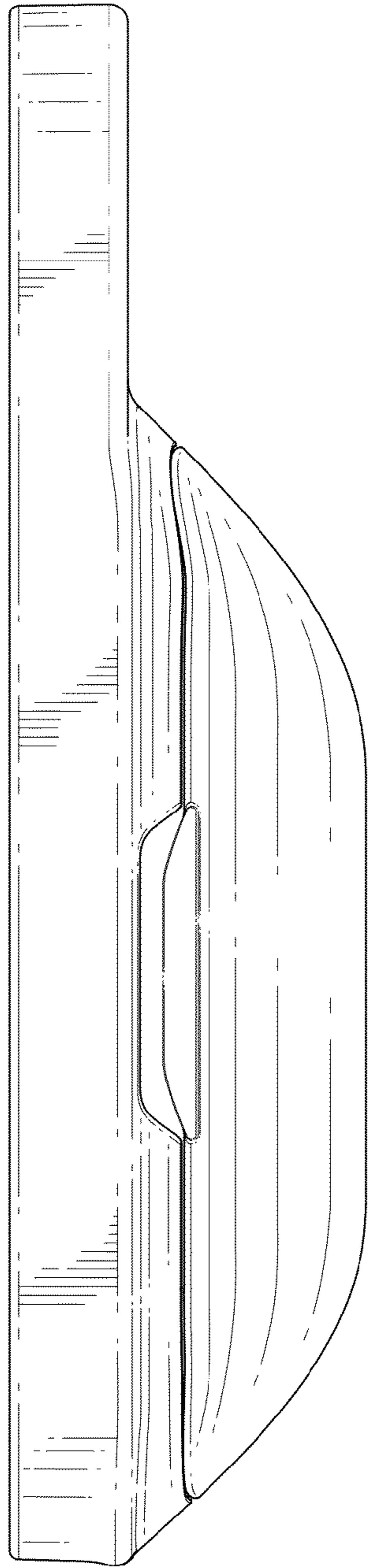

FIG. 5

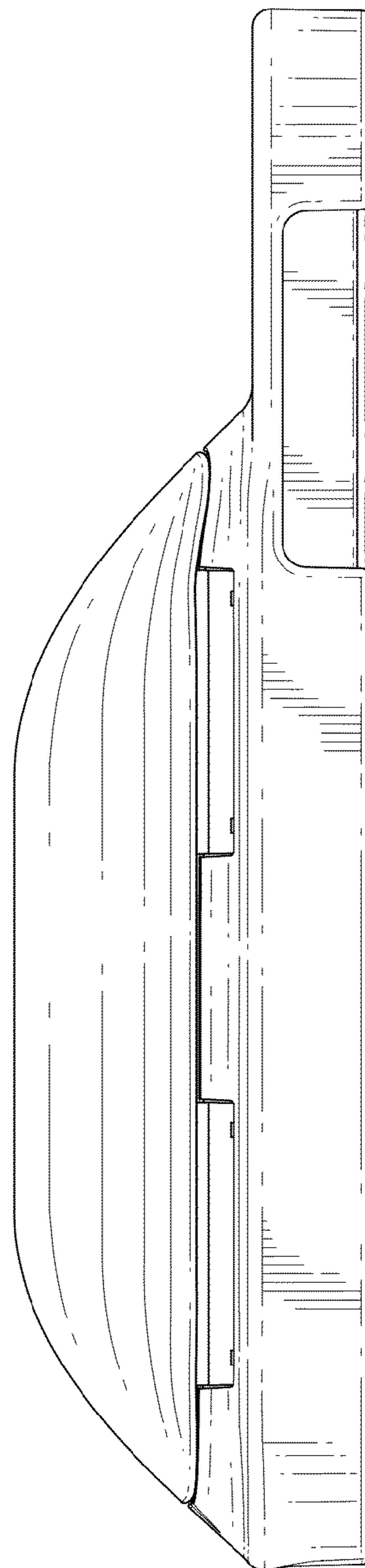

FIG. 6

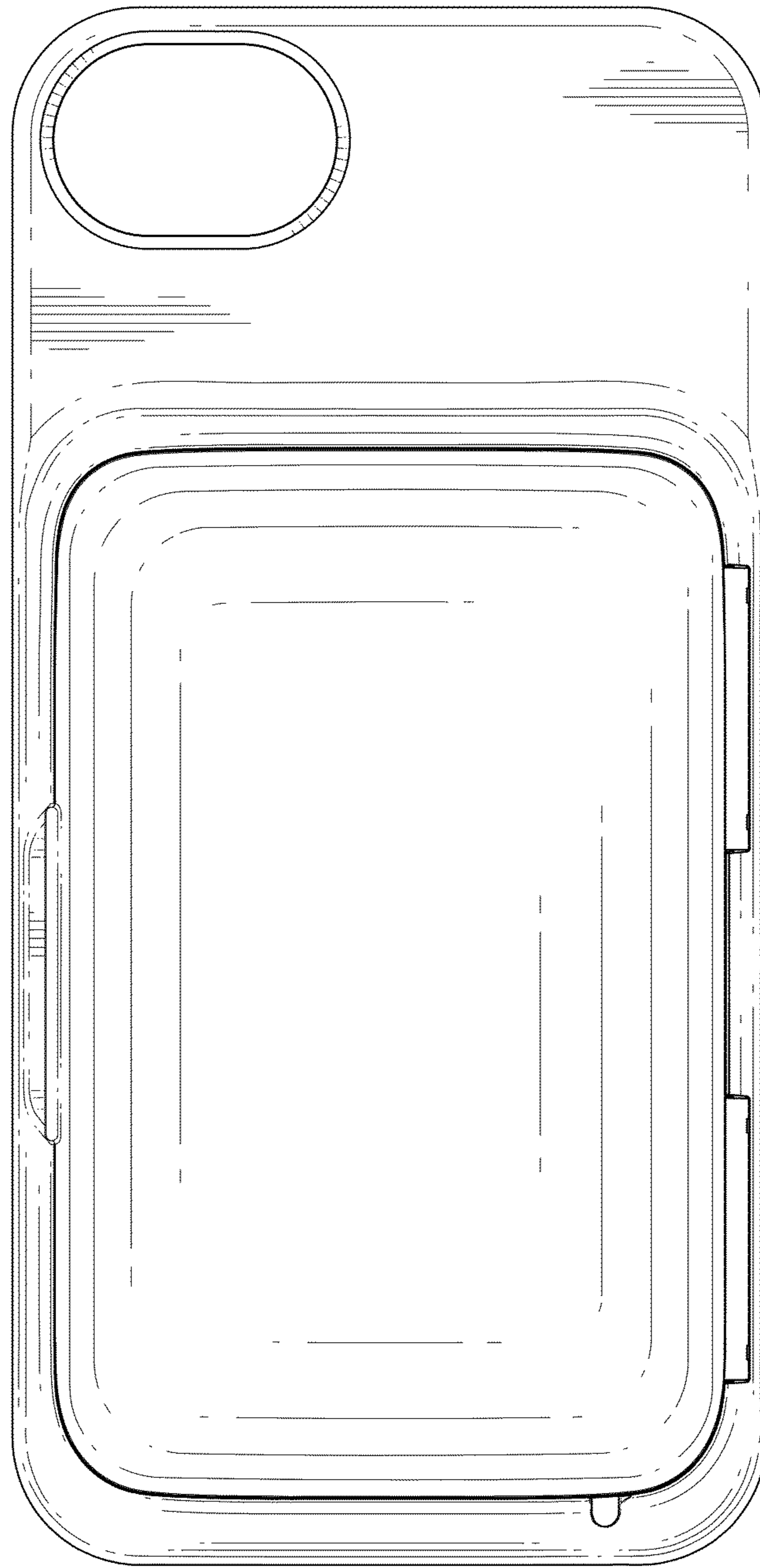

FIG. 7

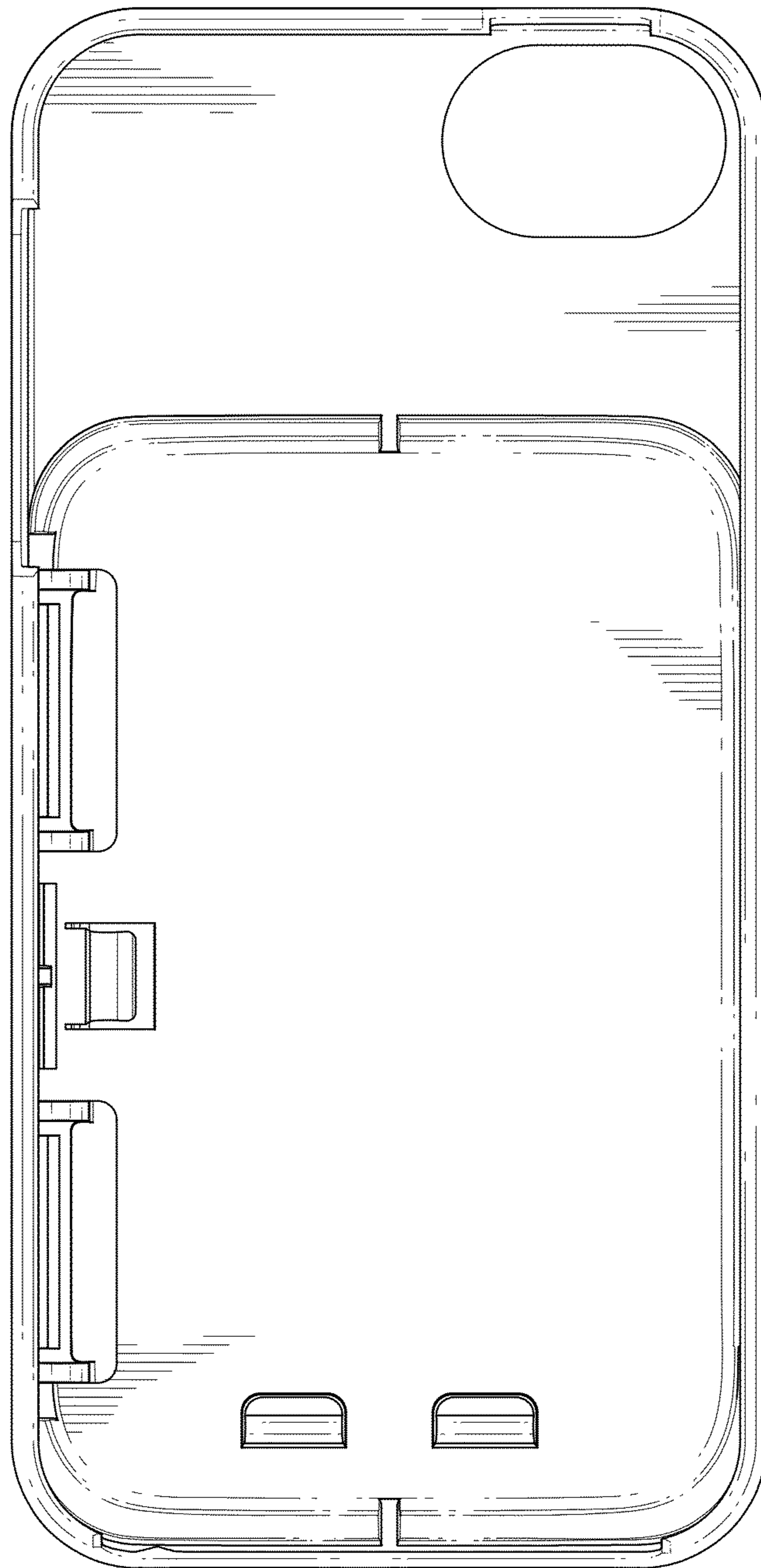

FIG. 8

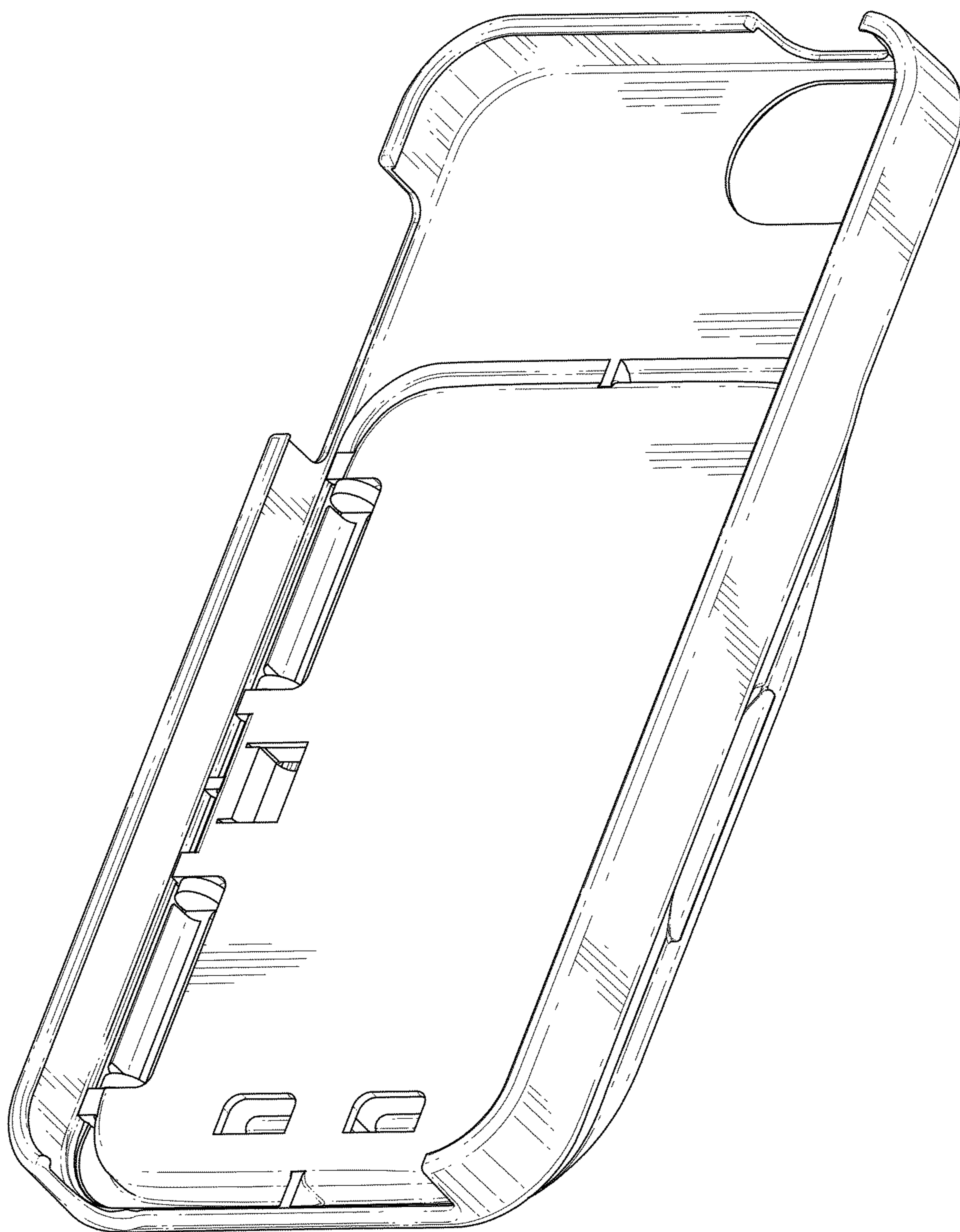

FIG. 9