



US00D759000S

(12) **United States Design Patent**
Behar

(10) **Patent No.:** **US D759,000 S**
(45) **Date of Patent:** **** Jun. 14, 2016**

(54) **STAND FOR TELEVISION RECEIVER**

(71) Applicant: **Samsung Electronics Co., Ltd.**,
Suwon-si (KR)

(72) Inventor: **Yves Behar**, San Francisco, CA (US)

(73) Assignee: **Samsung Electronics Co., Ltd.**,
Suwon-si (KR)

(**) Term: **14 Years**

(21) Appl. No.: **29/517,899**

(22) Filed: **Feb. 18, 2015**

(30) **Foreign Application Priority Data**

Aug. 20, 2014 (KR) 30-2014-0040578

(51) **LOC (10) Cl.** **14-03**

(52) **U.S. Cl.**
USPC **D14/239**

(58) **Field of Classification Search**

USPC D14/125-134, 239, 371, 136, 374-377,
D14/440, 450, 448, 336, 342, 159; 312/7.2;
348/836, 838, 180, 184, 325, 739;
248/917-924, 465; 345/104, 133, 156,
345/168, 87, 173; D21/329, 515, 577, 622,
D21/333, 433, 448, 452, 450, 331, 505;
D10/15, 26; 446/484, 175, 356;
D6/477, 479, 300; D24/185; D34/14
CPC ... G06F 1/1601; G06F 1/1643; H05K 5/0004;
H05K 5/0017; H05K 5/02; H05K 5/0217
See application file for complete search history.

(56) **References Cited**

U.S. PATENT DOCUMENTS

D508,055 S * 8/2005 Lo D14/451
D530,327 S * 10/2006 Chen et al. D14/375
D535,265 S * 1/2007 Inoue D14/126
D556,756 S * 12/2007 Kataoka et al. D14/375

D680,982 S * 4/2013 Lee et al. D14/126
D684,981 S * 6/2013 Chang et al. D14/451
D698,745 S * 2/2014 Jung et al. D14/126
D699,232 S * 2/2014 Jung et al. D14/239

FOREIGN PATENT DOCUMENTS

KR D 2008-4443 11/2008
KR D 2010-11874 2/2011
KR 30-2010-0000680 5/2011
KR 30-2010-0009424 2/2014
KR 30-2010-0001413 4/2014

* cited by examiner

Primary Examiner — Randall Gholson

(74) *Attorney, Agent, or Firm* — NSIP Law

(57) **CLAIM**

I claim the ornamental design for a stand for television receiver, as shown and described.

DESCRIPTION

FIG. 1 is a front perspective view of a stand for television receiver showing my new design;
FIG. 2 is a front view thereof;
FIG. 3 is a rear view thereof;
FIG. 4 is a left-side view thereof;
FIG. 5 is a right-side view thereof;
FIG. 6 is a top view thereof;
FIG. 7 is a bottom view thereof;
FIG. 8 is a rear perspective view thereof;
FIG. 9 is a second front perspective view of the stand for television receiver in which a display screen is provided in broken lines to illustrate an example environment; and,
FIG. 10 is a third perspective view of the stand for television receiver shown in an alternate position in which a display screen is provided in broken lines to illustrate an example environment.

The broken lines in the figures show portions of the stand for television receiver which form no part of the claimed design.

1 Claim, 8 Drawing Sheets

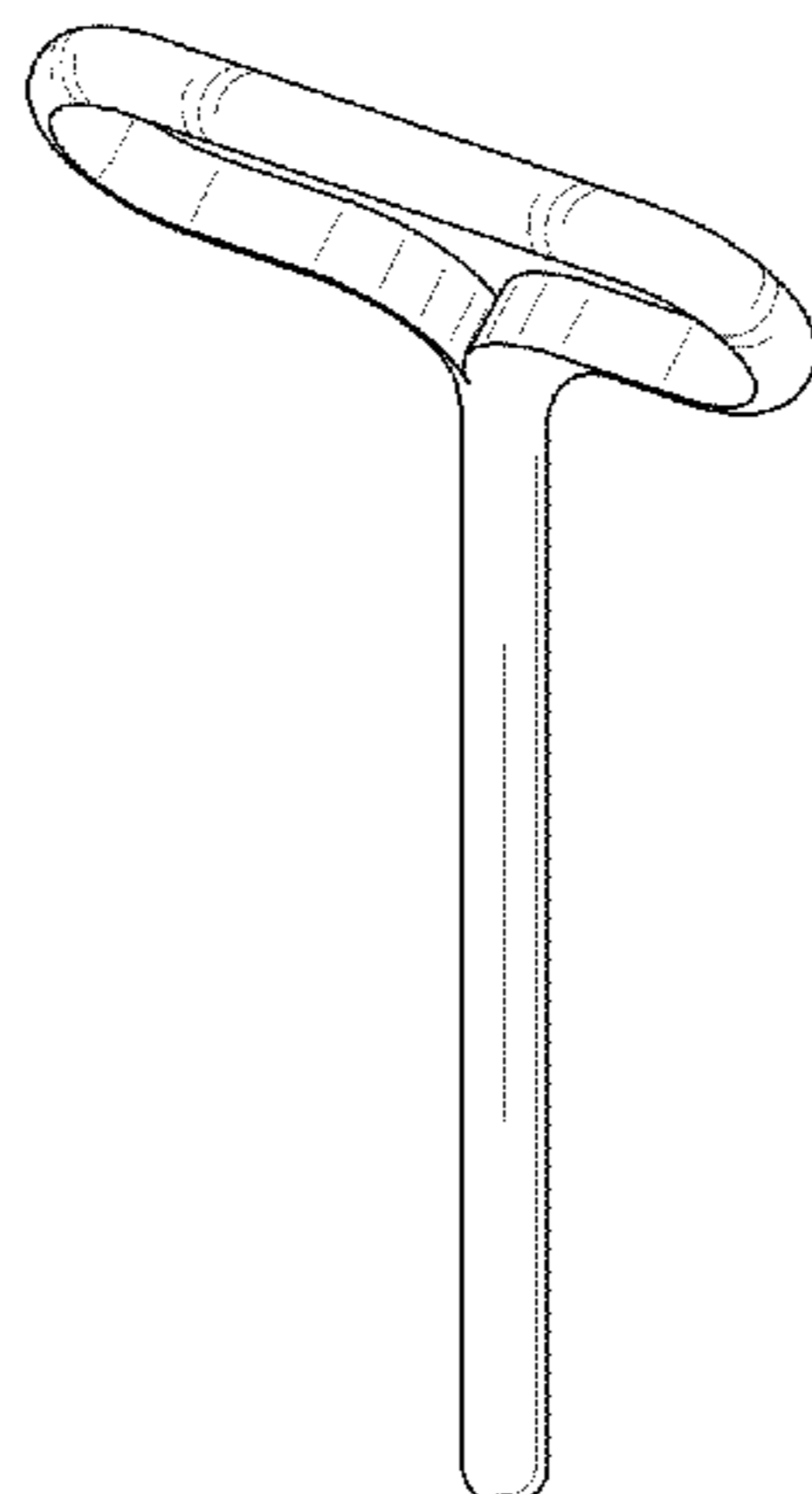

FIG. 1

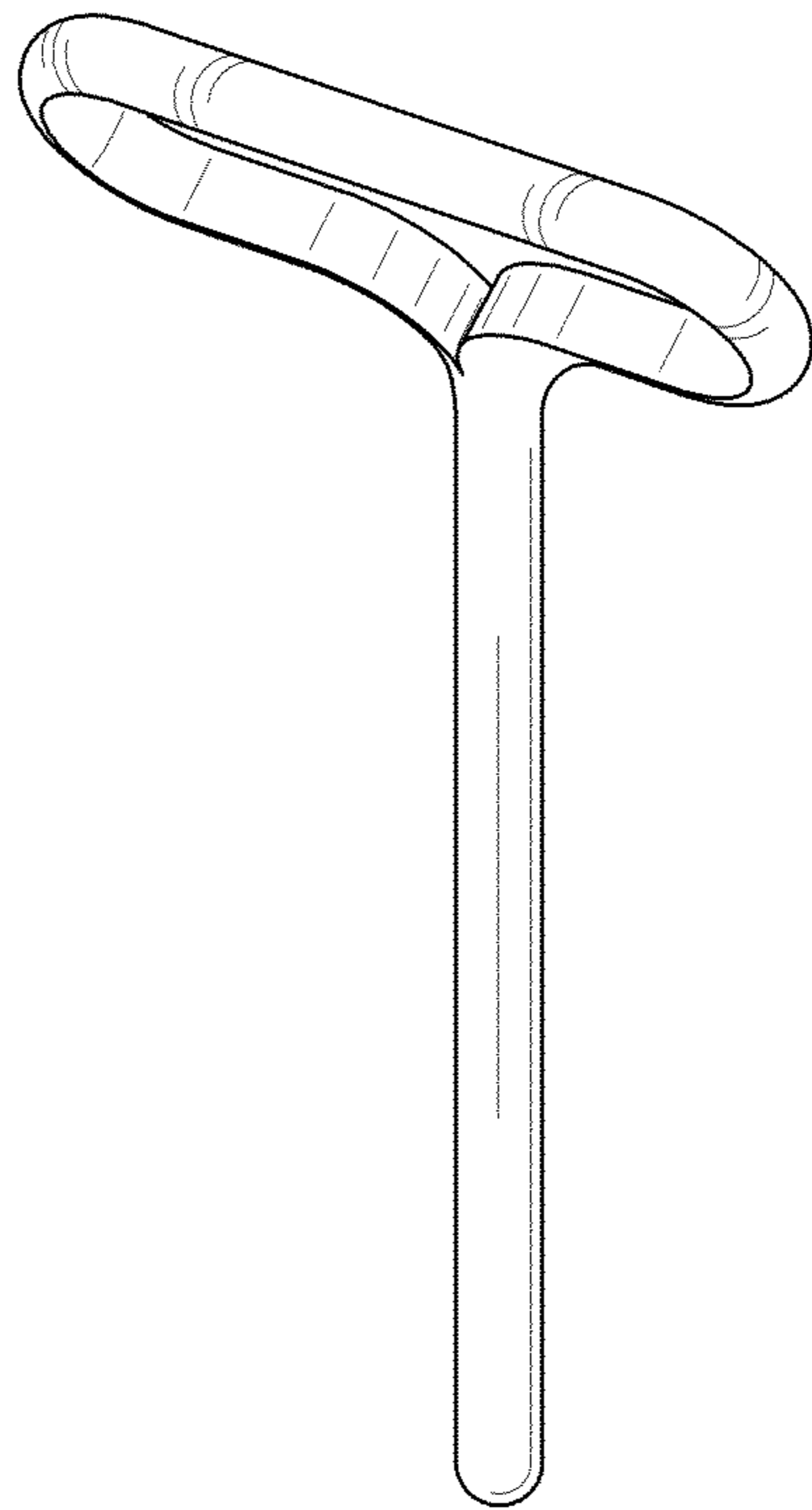

FIG. 2

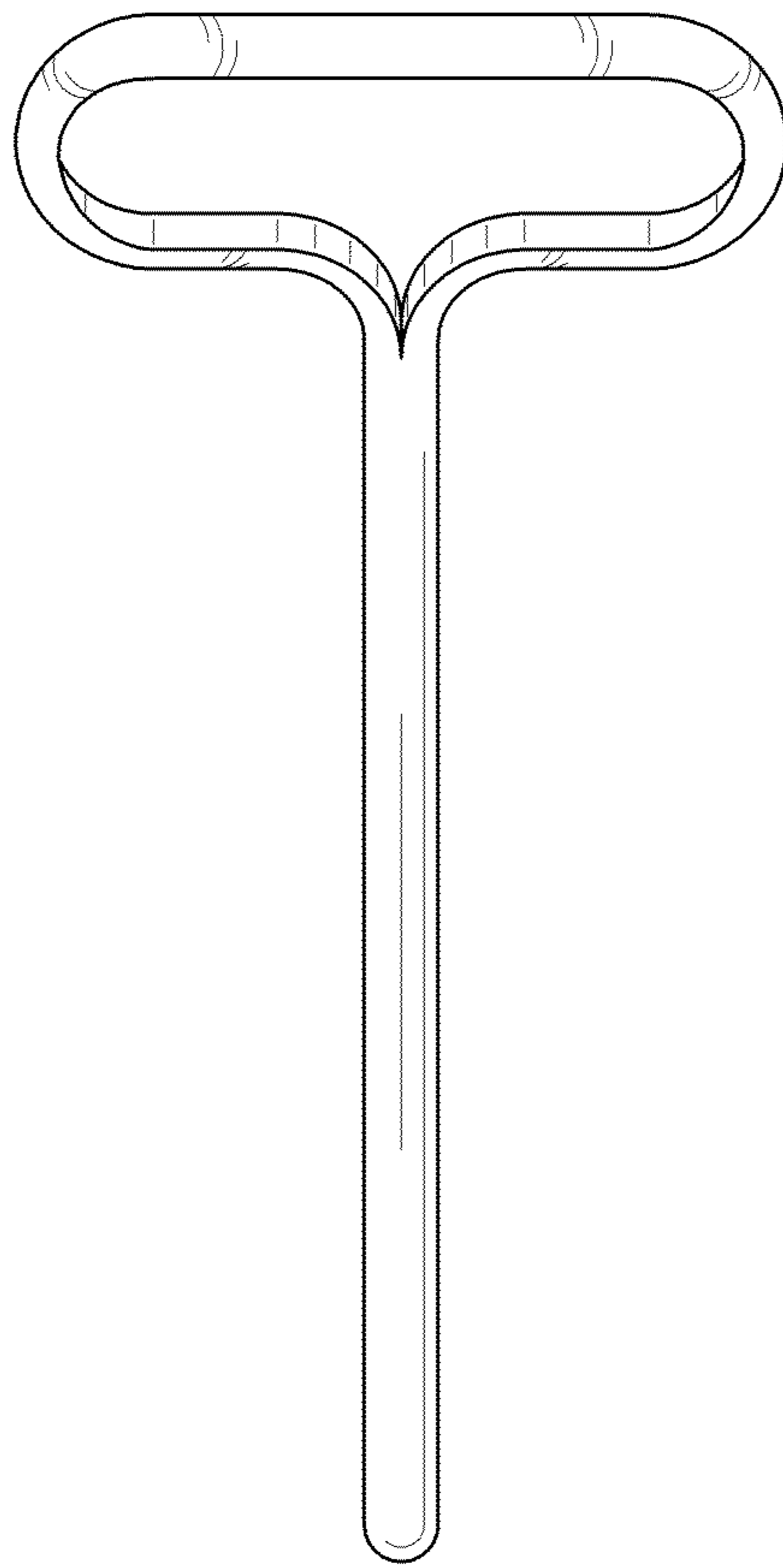

FIG. 3

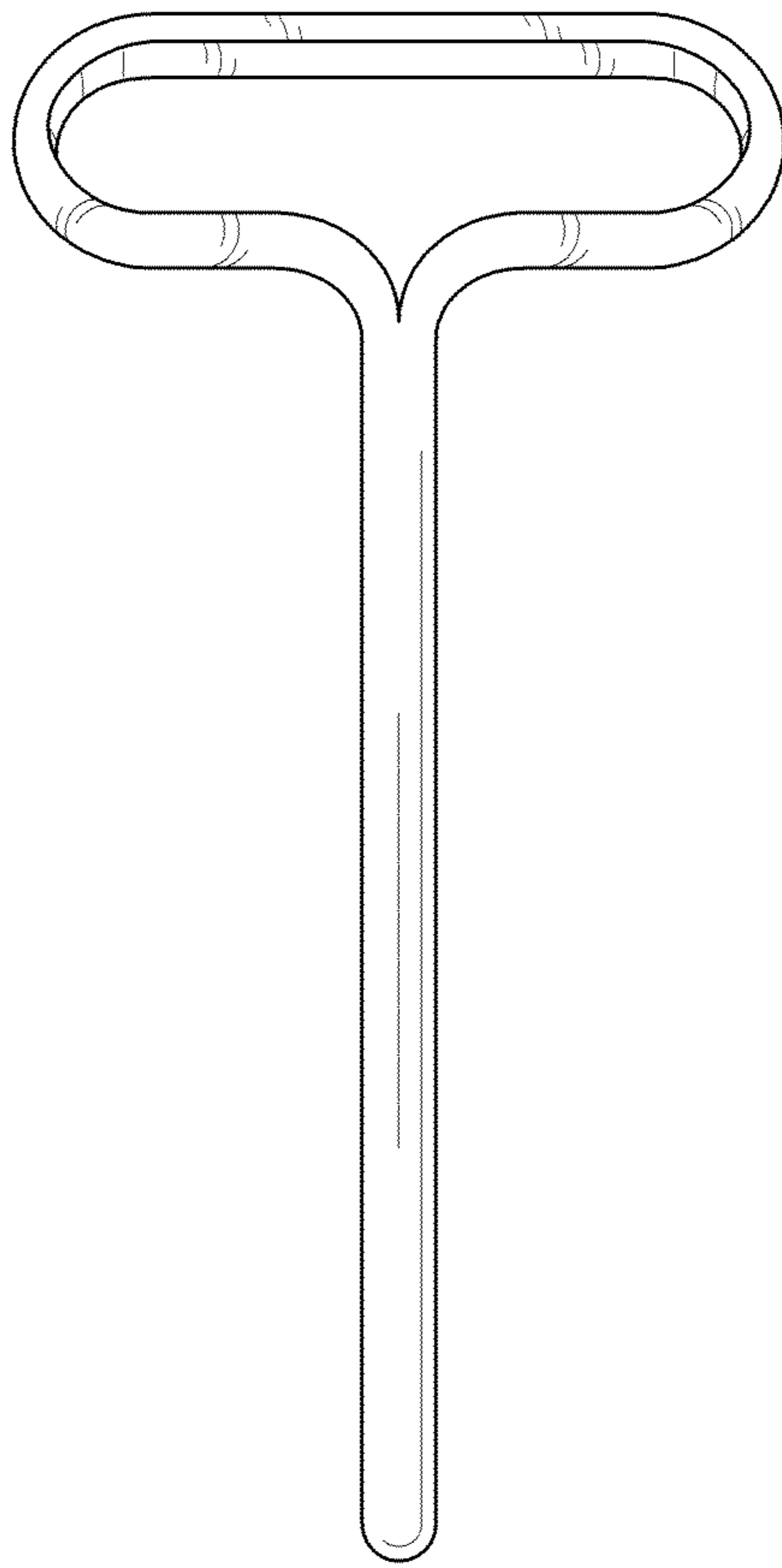

FIG. 4

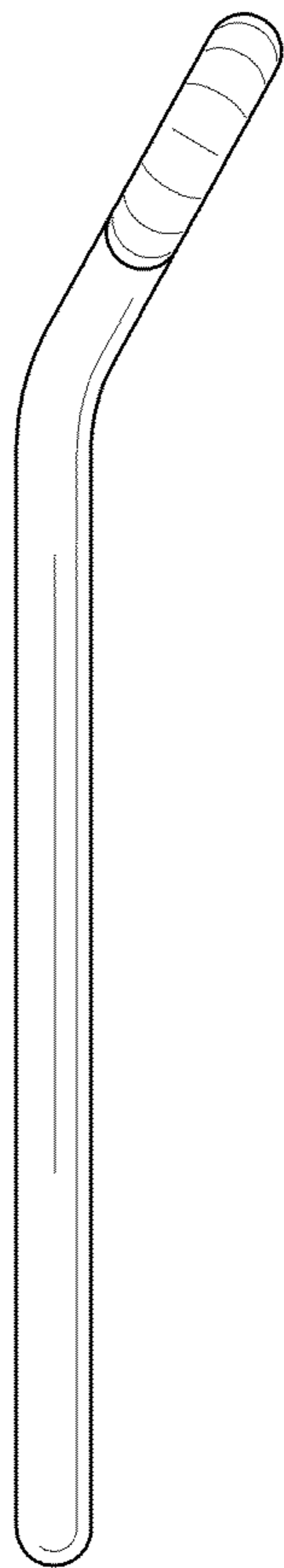

FIG. 5

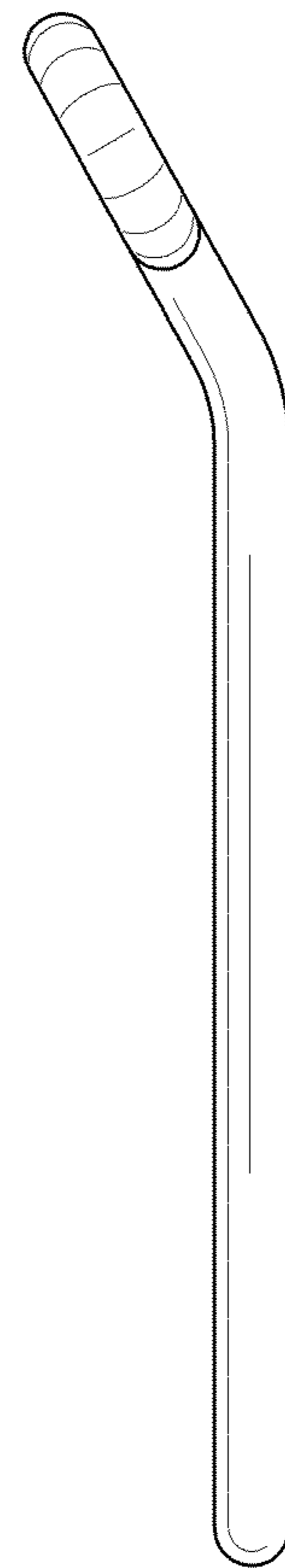

FIG. 6

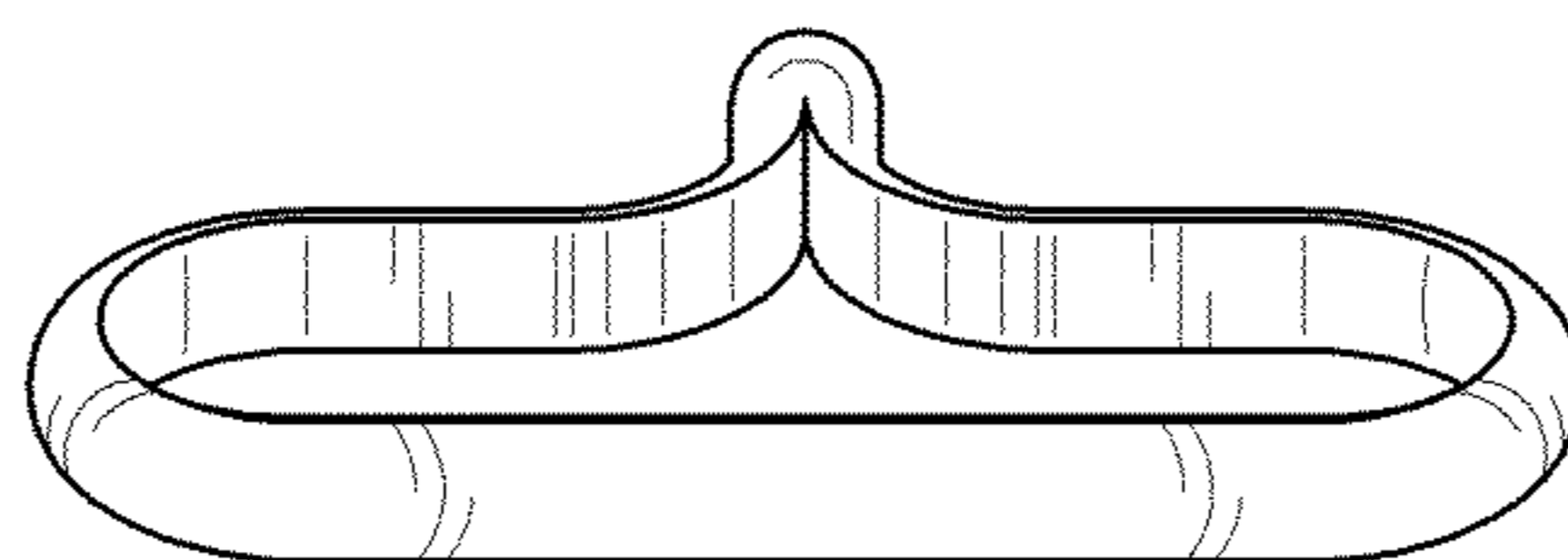

FIG. 7

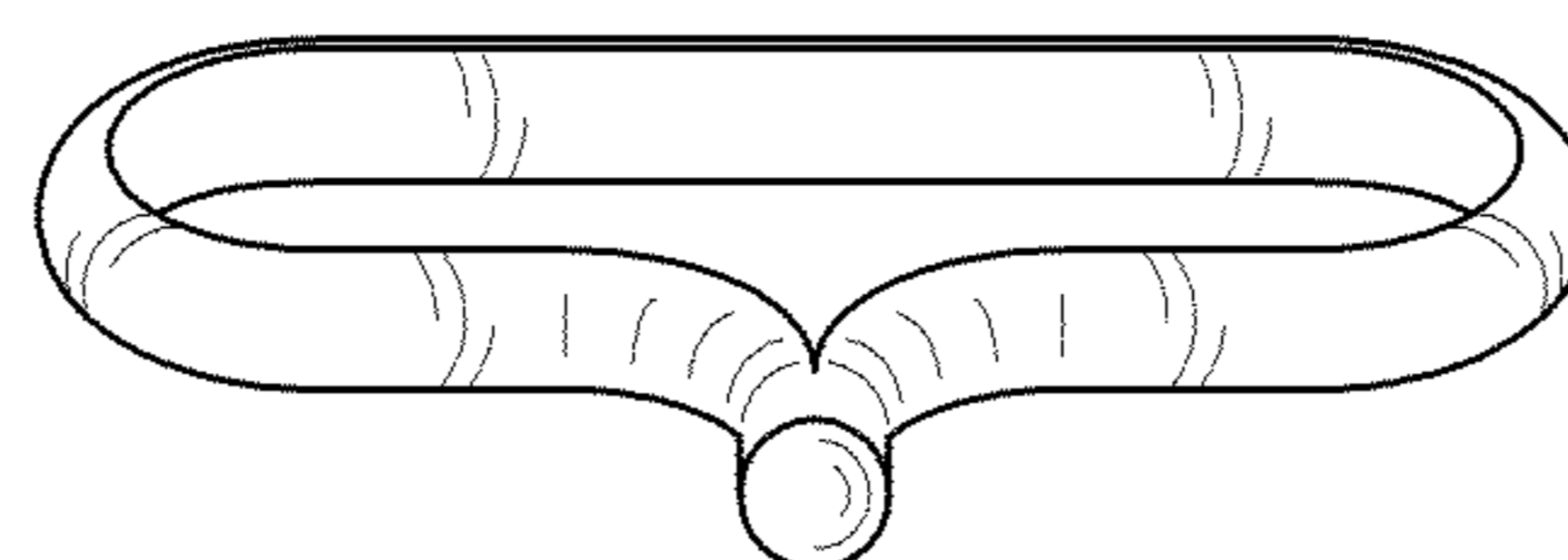

FIG. 8

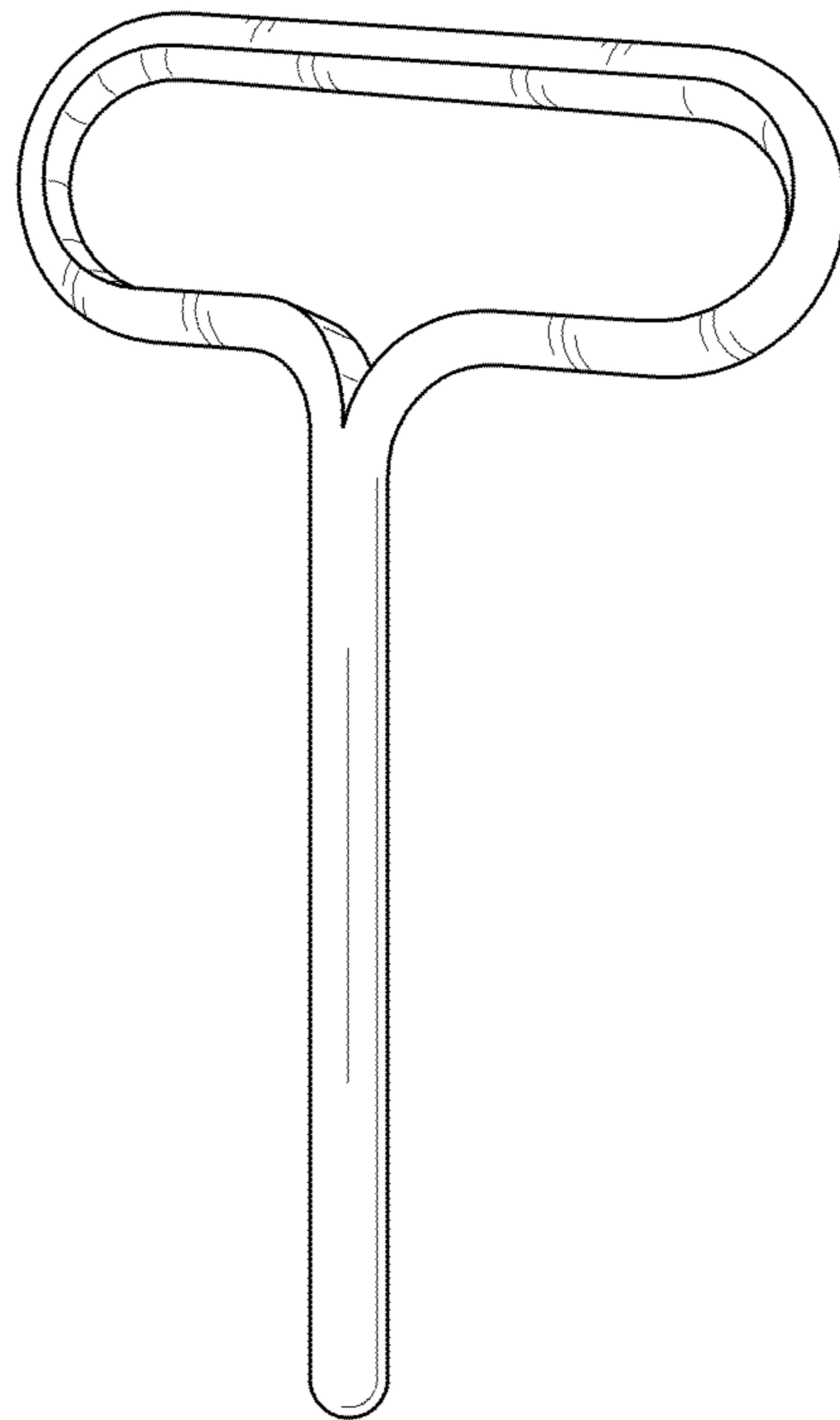

FIG. 9

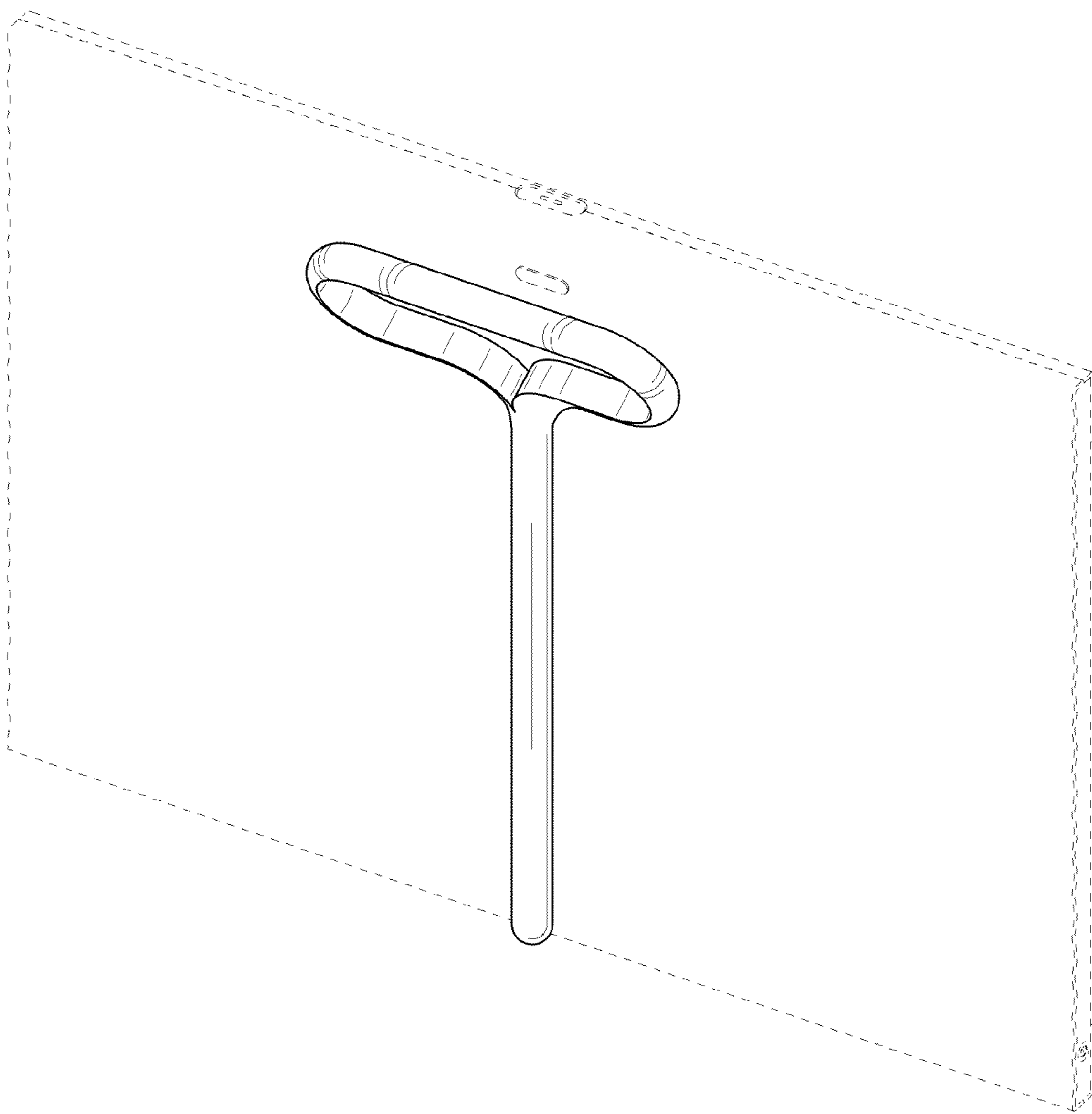

FIG. 10

