



US00D758996S

(12) **United States Design Patent**
Wai

(10) **Patent No.:** **US D758,996 S**
(45) **Date of Patent:** **** Jun. 14, 2016**

(54) **WEARABLE REMOTE CONTROL**

(71) Applicant: **Victor K. Wai**, Siu Lam (HK)

(72) Inventor: **Victor K. Wai**, Siu Lam (HK)

(**) Term: **14 Years**

(21) Appl. No.: **29/496,463**

(22) Filed: **Jul. 14, 2014**

(51) **LOC (10) Cl.** **14-03**

(52) **U.S. Cl.**
USPC **D14/218**

(58) **Field of Classification Search**

USPC D14/135, 144, 218, 480.3, 496;
D13/168, 173, 162, 162.1, 166, 171,
D13/174; D30/152; D10/30-36, 38, 70,
D10/104.2, 103, 128; D11/4
CPC . A45F 2005/008; G06F 3/016; H04N 5/4403;
H04N 5/765; G08C 23/04
See application file for complete search history.

(56) **References Cited**

U.S. PATENT DOCUMENTS

D238,293 S * 12/1975 Durante D11/4
5,228,012 A * 7/1993 Seager A44C 5/0007
224/165
D342,740 S * 12/1993 Parker D11/4
D366,036 S * 1/1996 Houlihan D10/30
D381,009 S * 7/1997 Nagata D10/106.1
D460,430 S * 7/2002 Wada D10/31
D549,221 S * 8/2007 Yagi D11/4
D550,214 S * 9/2007 Francz D14/218
D567,227 S * 4/2008 Hada D11/4
D596,610 S * 7/2009 Hou D10/32
D722,045 S * 2/2015 Mok D14/218
D725,068 S * 3/2015 Cho D14/138 R
2007/0270199 A1 * 11/2007 Kim H04B 1/385
455/575.6

FOREIGN PATENT DOCUMENTS

EM 000622709-0003 * 2/2007
EM 000756200-0001 * 9/2007

OTHER PUBLICATIONS

Aliexpress.com Smart Wristband L12S OLED Bluetooth Smart Bracelet Wrist Watch Design, review date Jul. 2, 2015, online, [http://www.aliexpress.com/item/Smart-Wristband-L12S-OLED-Bluetooth-Smart-Bracele . . .](http://www.aliexpress.com/item/Smart-Wristband-L12S-OLED-Bluetooth-Smart-Bracele...), site visited Oct. 21, 2015.*
Amazon.com: Scosche Extreme Sport Wrist-Mounted iPod Remote Control, review date Nov. 20, 2015, online, <http://www.amazon.com/Scosche-Extreme-Wrist-Mounted-Remote-Control/dp/B000BKSRUE#customerReviews>, [site visited Oct. 21, 2015 6:09:43 PM].*
Amazon.com : Velcro Wrist Strap for GoPro WiFi Remote Control, review date Aug. 22, 2013, online, <http://www.amazon.com/Velcro-Wrist-Remote-Control-Accessory/dp/B00BD25HJS>, [site visited Oct. 21, 2015 6:11:29 PM].*
Nike Amp+ Sport Remote Control Wrist Watch, article date Oct. 8, 2007, online, <http://www.digitaltechnews.com/news/2007/10/nike-amp-sport-.html>, [site visited Oct. 21, 2015 6:13:50 PM].*

* cited by examiner

Primary Examiner — John Windmuller

Assistant Examiner — John R Yeh

(74) *Attorney, Agent, or Firm* — Michael R. Schacht; Schacht Law Office, Inc.

(57) **CLAIM**

The ornamental design for a wearable remote control, as shown and described.

DESCRIPTION

FIG. 1 is an isometric view of a wearable remote control showing my new design;
FIG. 2 is a front view thereof;
FIG. 3 is a right side view thereof;
FIG. 4 is a left side view thereof;
FIG. 5 is a back view thereof;
FIG. 6 is a top view thereof; and,
FIG. 7 is a bottom view thereof.

1 Claim, 3 Drawing Sheets

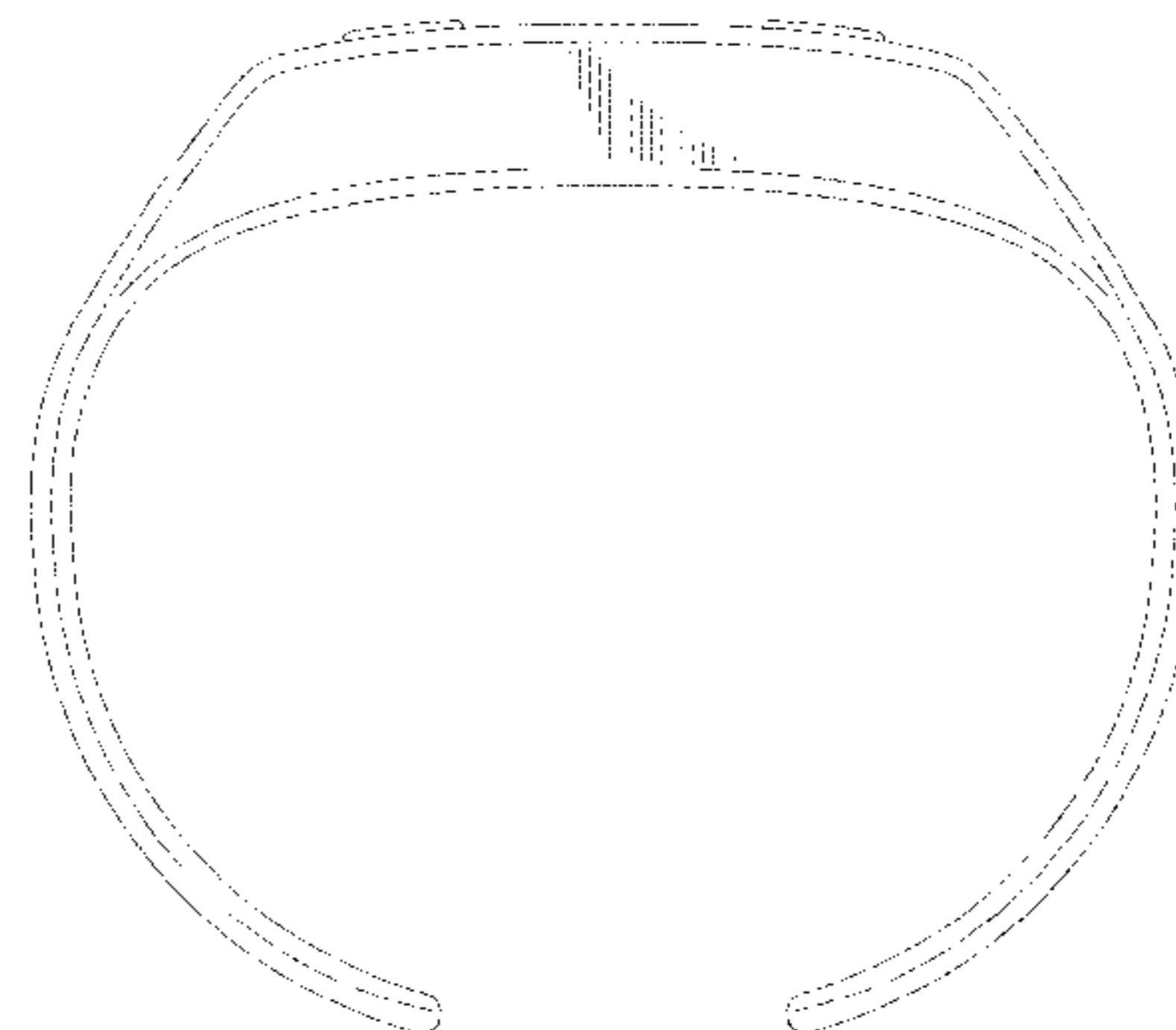
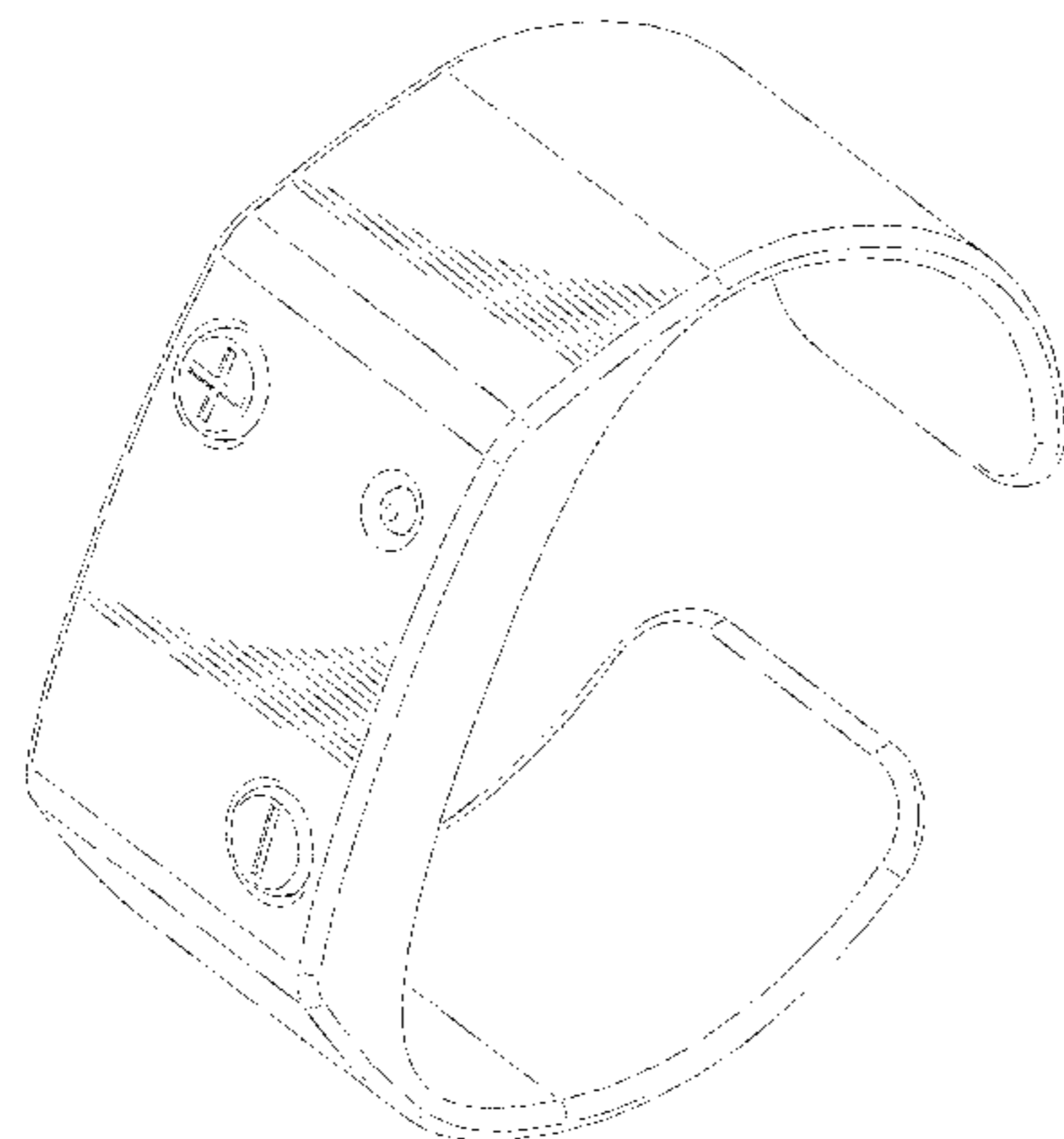

FIG. 1

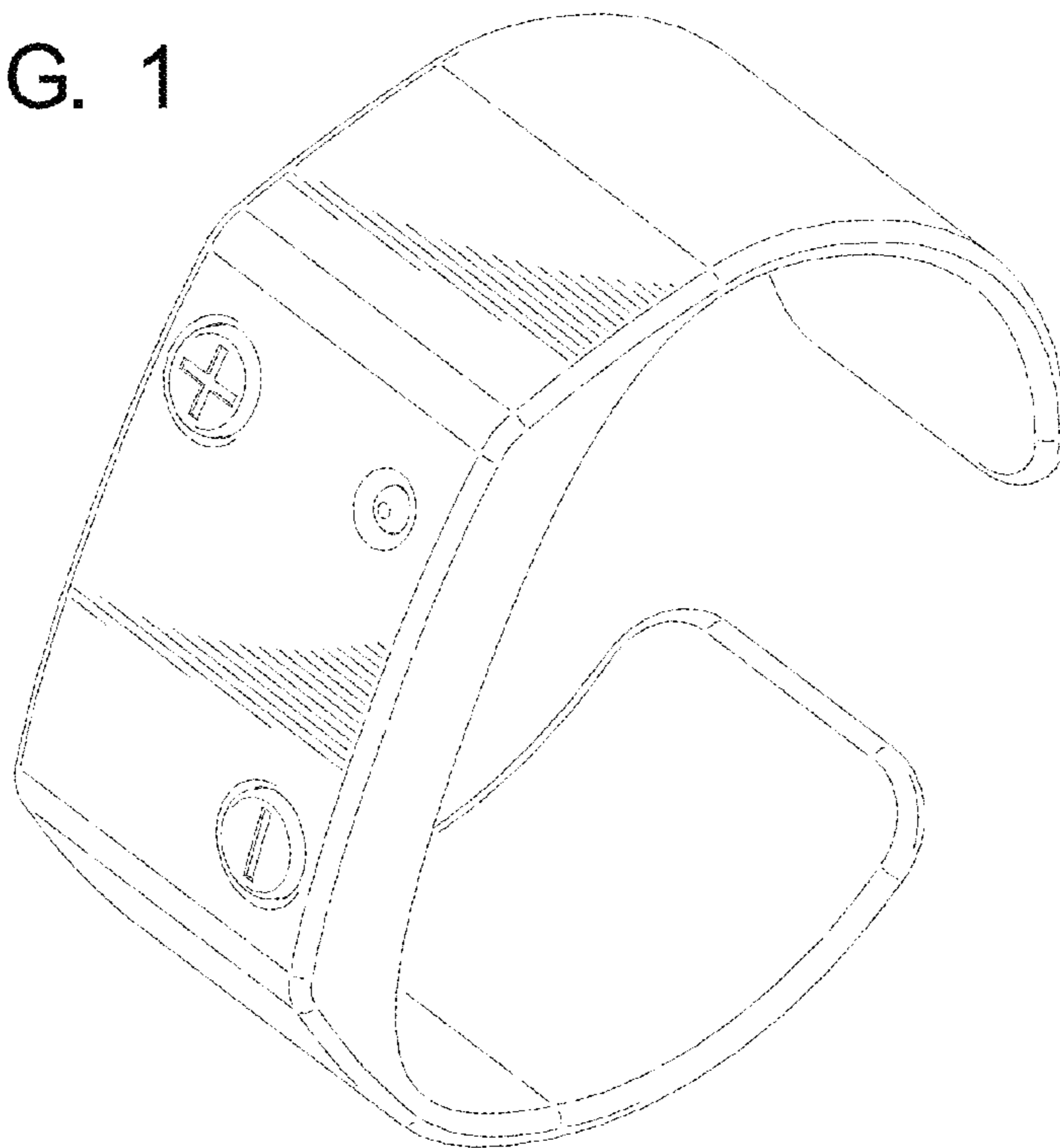

FIG. 2

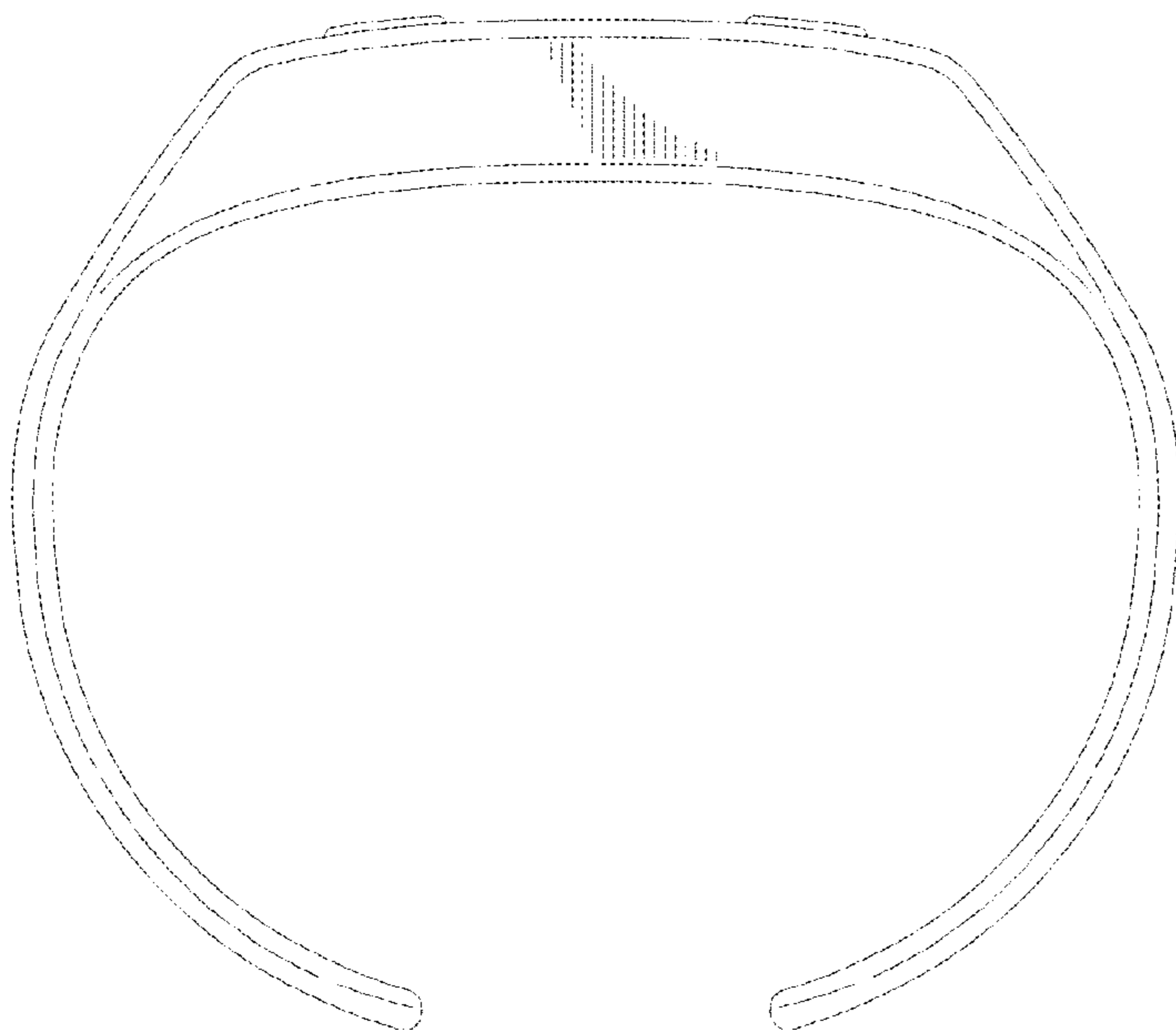

FIG. 3

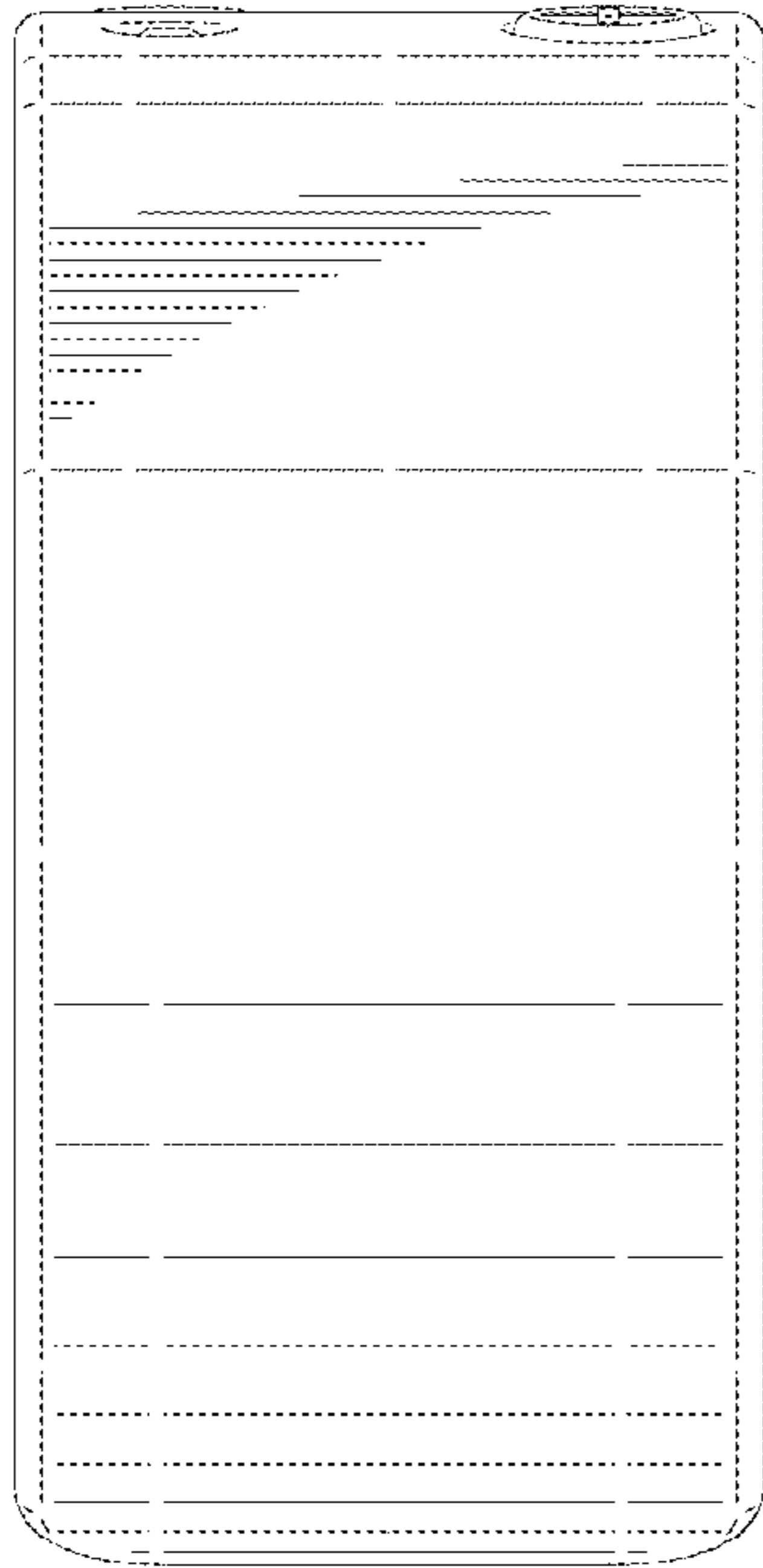

FIG. 4

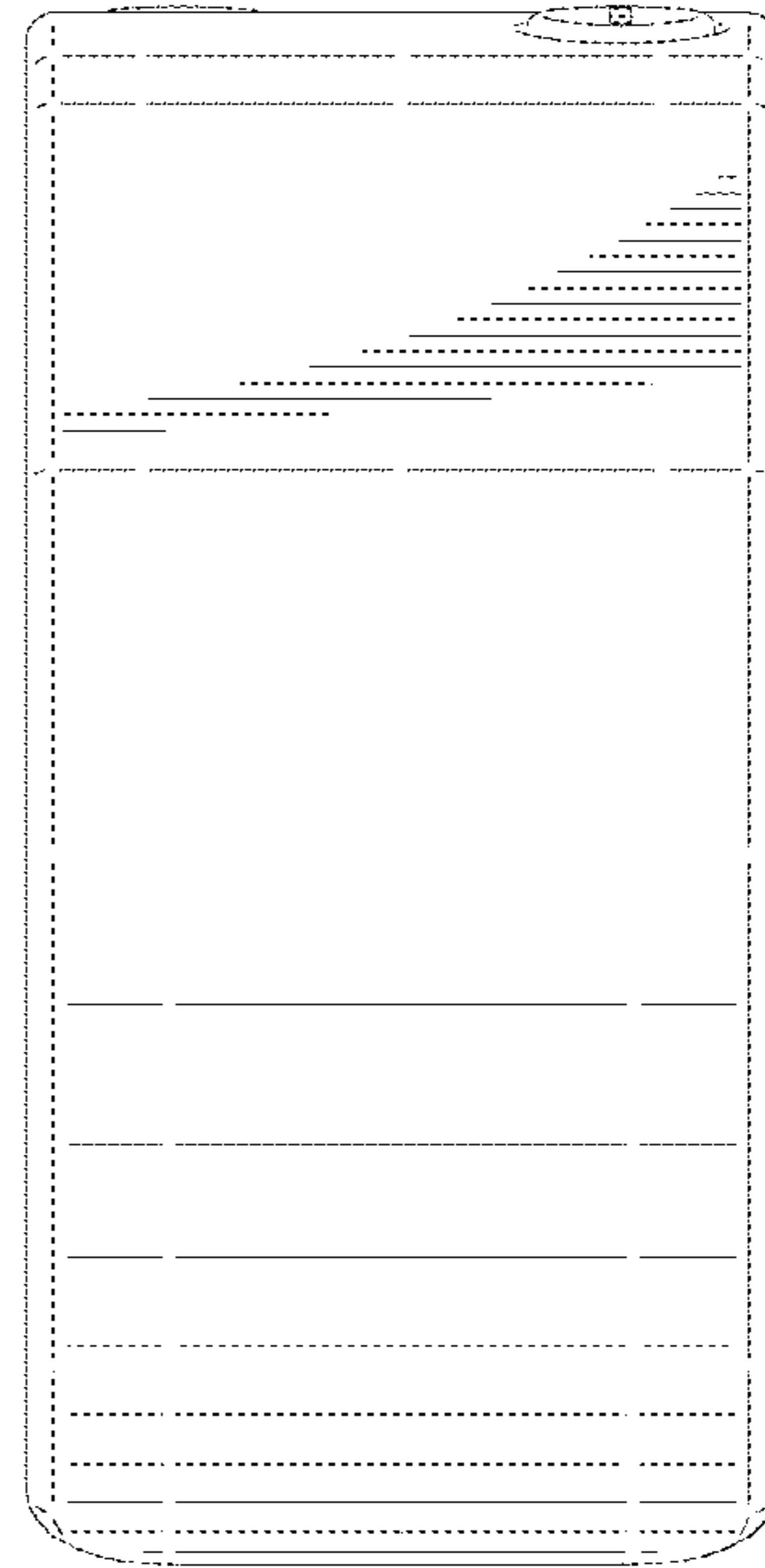

FIG. 5

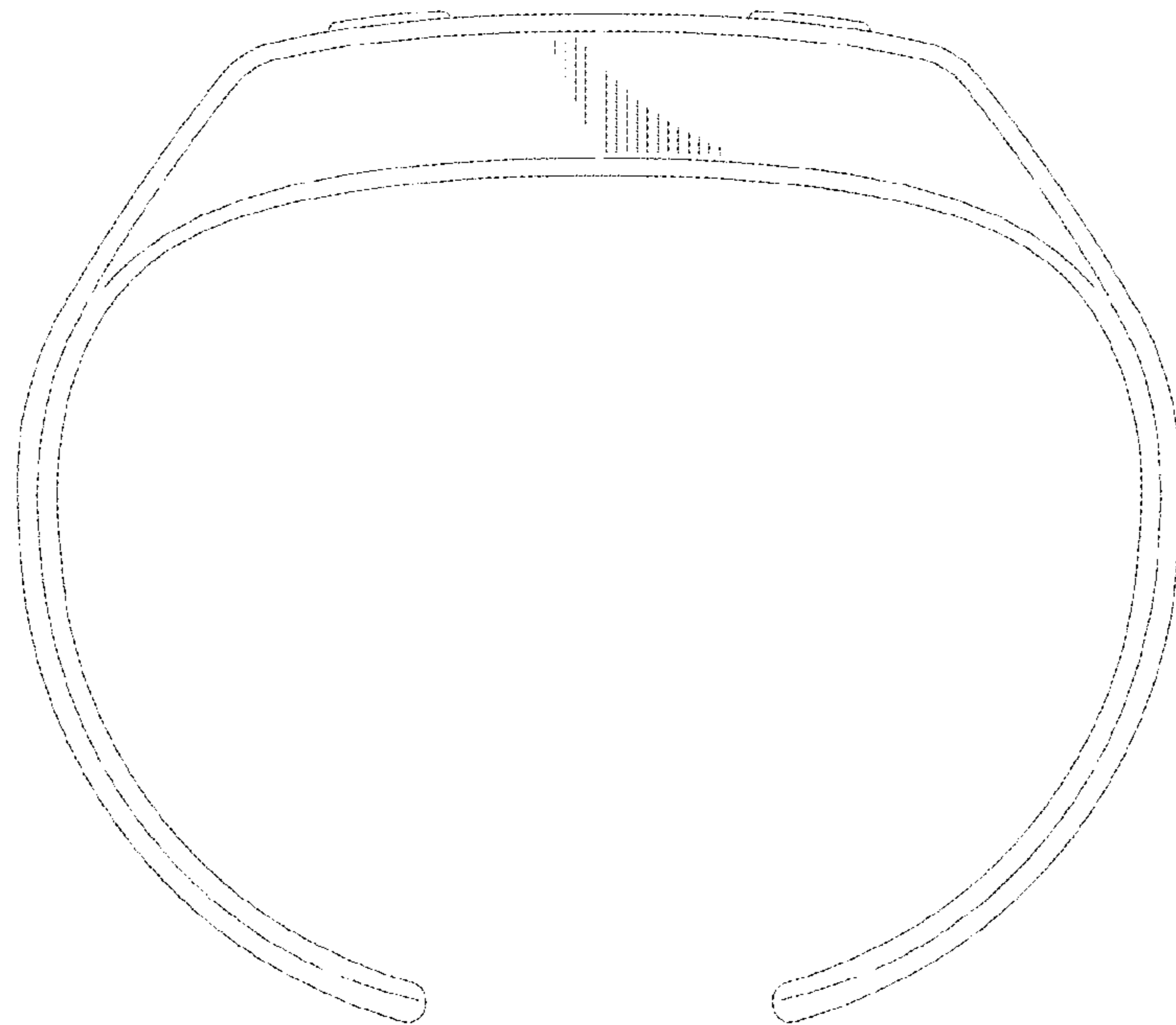

FIG. 6

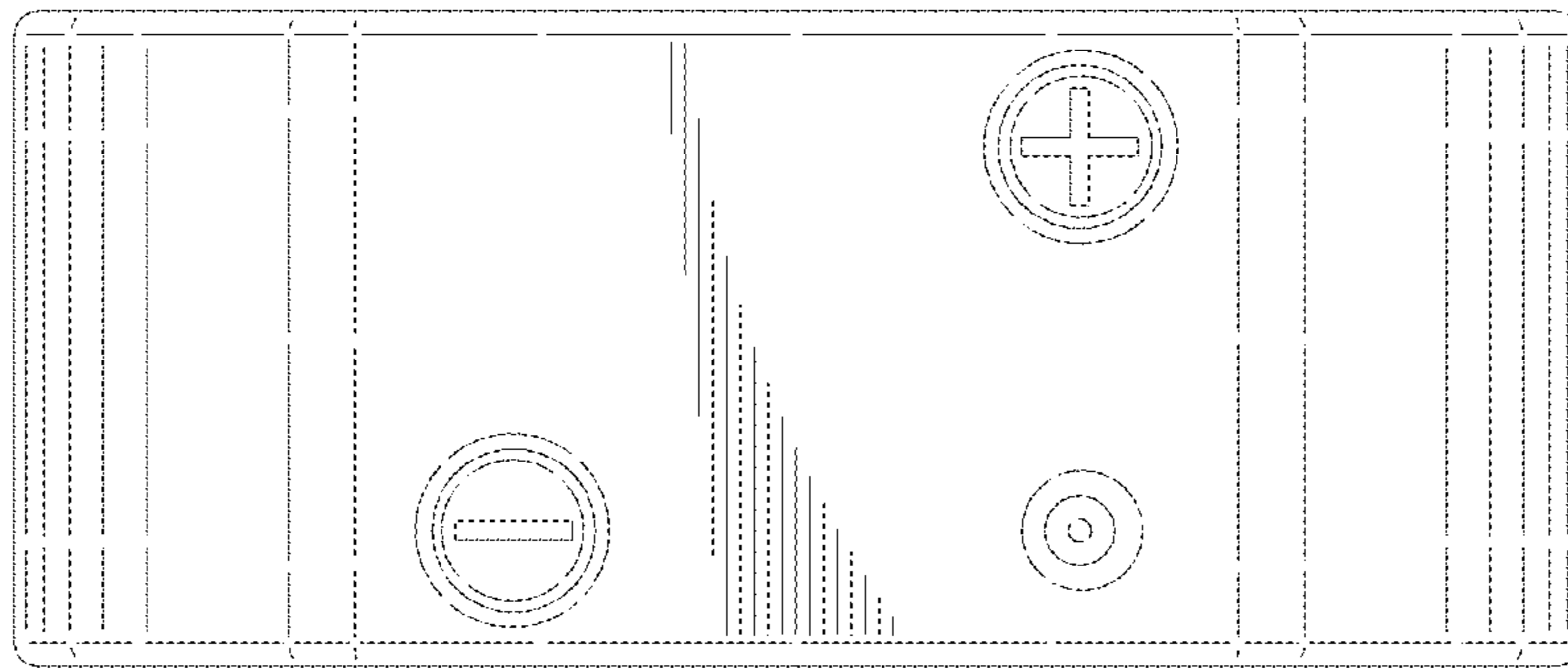

FIG. 7

