



US00D758950S

(12) **United States Design Patent**
Scooler et al.

(10) **Patent No.:** **US D758,950 S**
(45) **Date of Patent:** **** Jun. 14, 2016**

(54) **AIRCRAFT FAIRING**

(71) Applicant: **Gulfstream Aerospace Corporation,**
Savannah, GA (US)

(72) Inventors: **James Scooler,** Savannah, GA (US);
Angel Barboza, Savannah, GA (US);
Guilherme Oliveria, Savannah, GA
(US); **Andre Martins,** Savannah, GA
(US); **Gerardo Ramirez,** Savannah, GA
(US)

(73) Assignee: **Gulfstream Aerospace Corporation,**
Savannah, GA (US)

(**) Term: **14 Years**

(21) Appl. No.: **29/506,146**

(22) Filed: **Oct. 13, 2014**

(51) **LOC (10) Cl.** **12-07**

(52) **U.S. Cl.**
USPC **D12/345**

(58) **Field of Classification Search**
USPC D12/319, 322, 323, 326, 327, 328, 329,
D12/330, 339, 341, 342, 343, 344, 345;
D21/436, 438, 439, 440, 441, 446, 447,
D21/448, 449, 450, 453
CPC B64C 39/00; B64C 30/00; B64C 29/00
See application file for complete search history.

(56) **References Cited**

U.S. PATENT DOCUMENTS

D326,842	S	*	6/1992	Buchsel et al.	D12/319
D499,688	S	*	12/2004	Atkinson et al.	D12/319
D500,281	S	*	12/2004	Aruga et al.	D12/319
D515,012	S	*	2/2006	Eatkins et al.	D12/319
D515,013	S	*	2/2006	Eatkins et al.	D12/319
D516,995	S	*	3/2006	Eatkins et al.	D12/319
D624,480	S	*	9/2010	Guering	D12/343

D629,349	S	*	12/2010	Hwang	D12/319
D634,696	S	*	3/2011	Saint-Jalmes et al.	D12/345
D733,031	S	*	6/2015	Horlin et al.	D12/345
2009/0184200	A1	*	7/2009	Lin et al.	244/1 N
2011/0204185	A1	*	8/2011	Lyons	244/130

OTHER PUBLICATIONS

Boeing B-727. dated 2/21/2015. found online [Aug. 24, 2015]
<http://aviationcentral.weebly.com/boeing-727.html>.
Gulfstream Aerospace Corporation, Gulfstream G150 Brochure.
Gulfstream Aerospace Corporation, Gulfstream G150 Fleet Product
Specifications.
Gulfstream Aerospace Corporation, Gulfstream G280 Fleet Product
Specifications.
Gulfstream Aerospace Corporation, Gulfstream G450 Fleet Product
Specifications.

(Continued)

Primary Examiner — Robert M Spear

Assistant Examiner — Marissa J Cash

(74) *Attorney, Agent, or Firm* — Ingrassia, Fisher & Lorenz
PC

(57) **CLAIM**

The ornamental design for an aircraft fairing, as shown and
described.

DESCRIPTION

FIG. 1 is a front perspective view of the aircraft fairing show-
ing our new design;
FIG. 2 is a front view thereof;
FIG. 3 is a back view thereof;
FIG. 4 is a first side view thereof;
FIG. 5 is a second side view thereof; and,
FIG. 6 is a bottom view thereof.

The even length broken lines illustrate structure and environ-
ment that form no part of the claimed design. The single long
dash and single short dash broken lines illustrate boundaries
of the claimed design that form no part thereof.

1 Claim, 4 Drawing Sheets

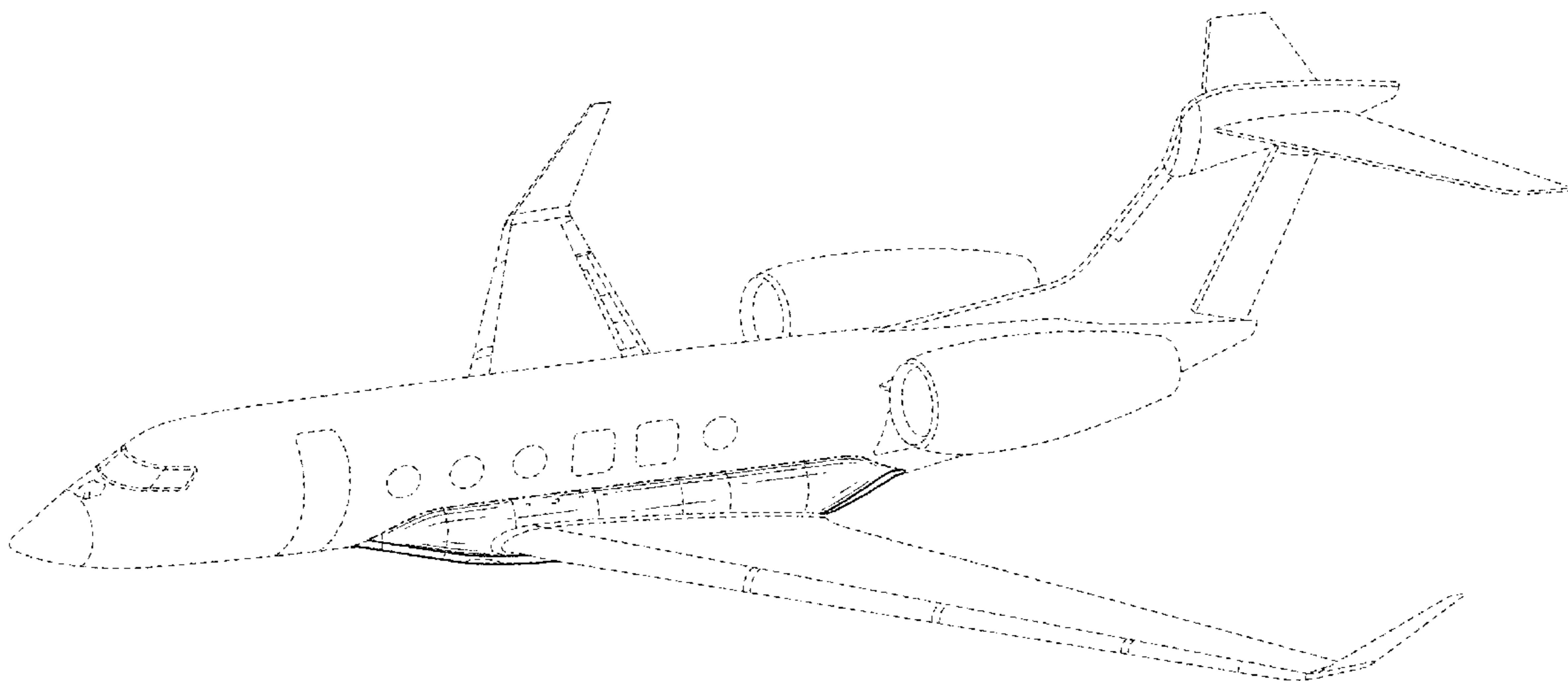

(56)

References Cited

OTHER PUBLICATIONS

Gulfstream Aerospace Corporation, Gulfstream G550 Fleet Product Specifications.

Gulfstream Aerospace Corporation, Gulfstream G650 Product Brochure.

Gulfstream Aerospace Corporation, Gulfstream G650 Product Specification.

Gulfstream Aerospace Corporation, Gulfstream G650ER Product Specification.

* cited by examiner

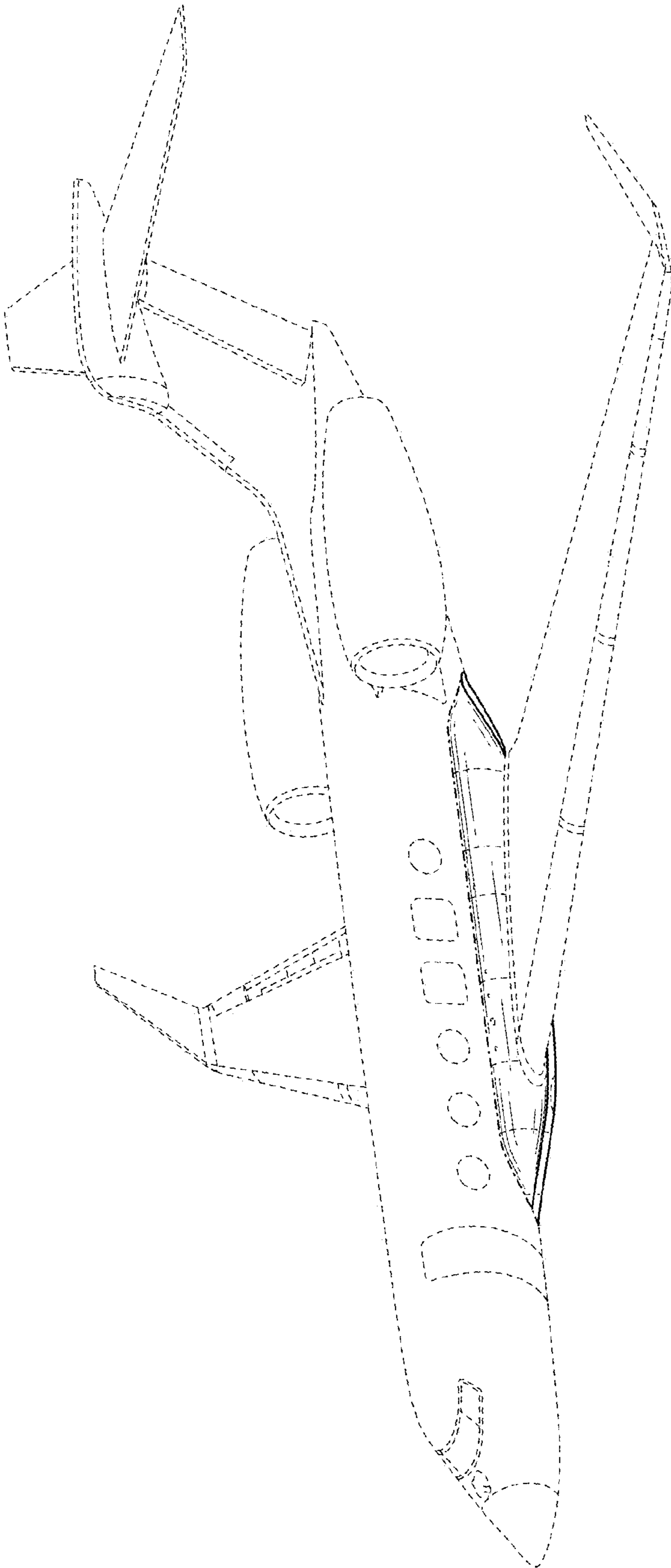

FIG. 1

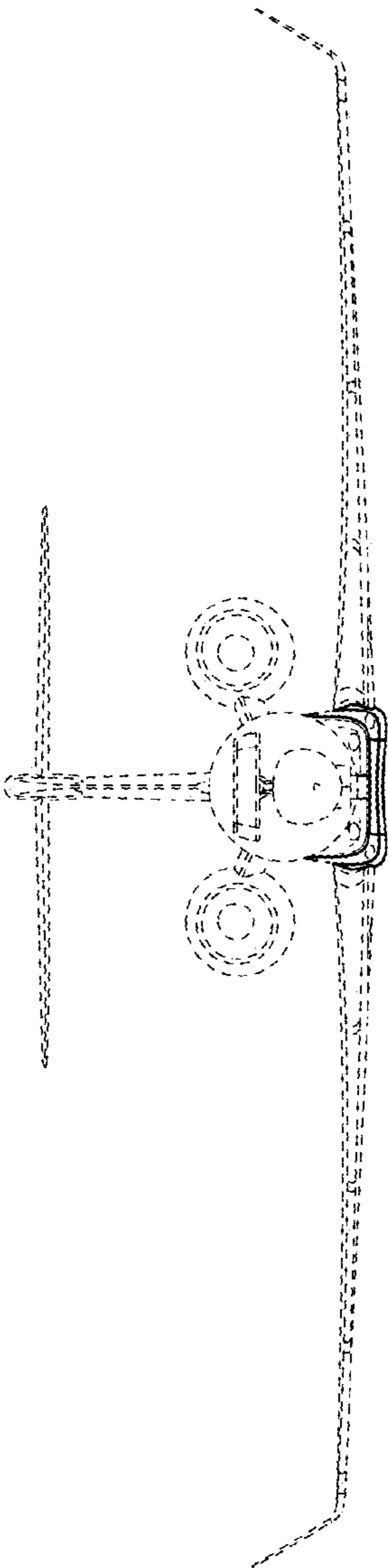

FIG. 2

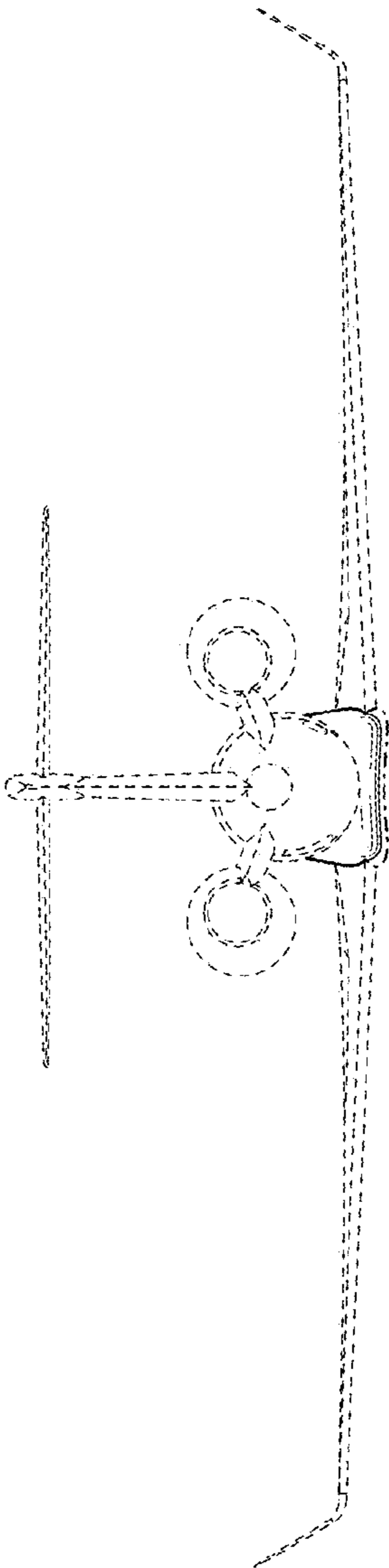

FIG. 3

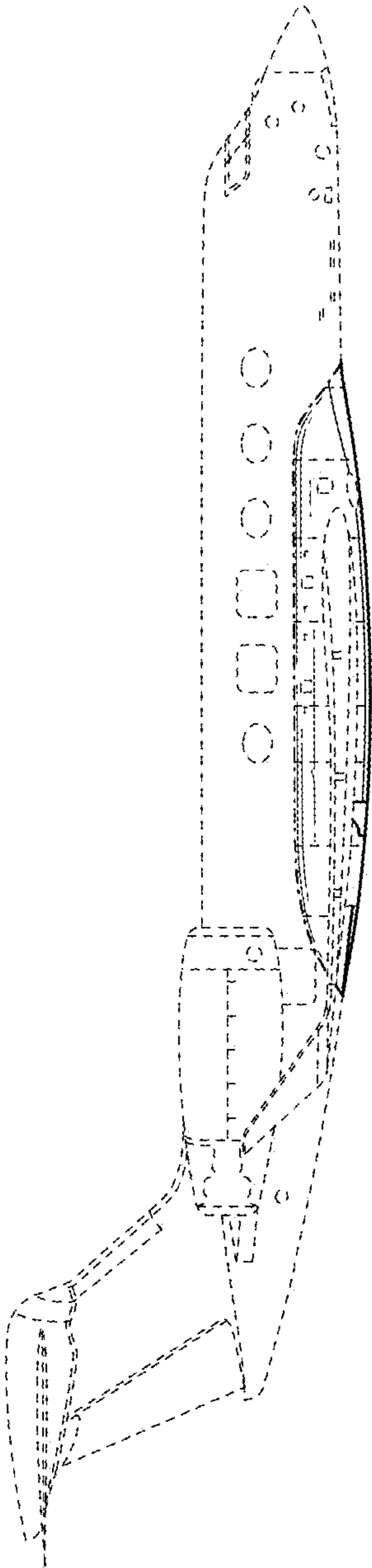

FIG. 4

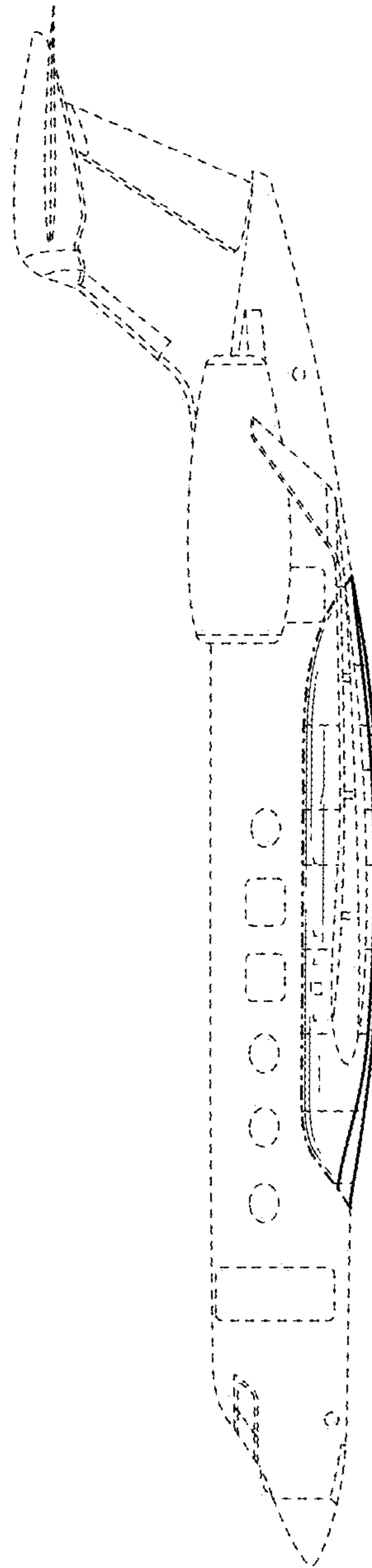

FIG. 5

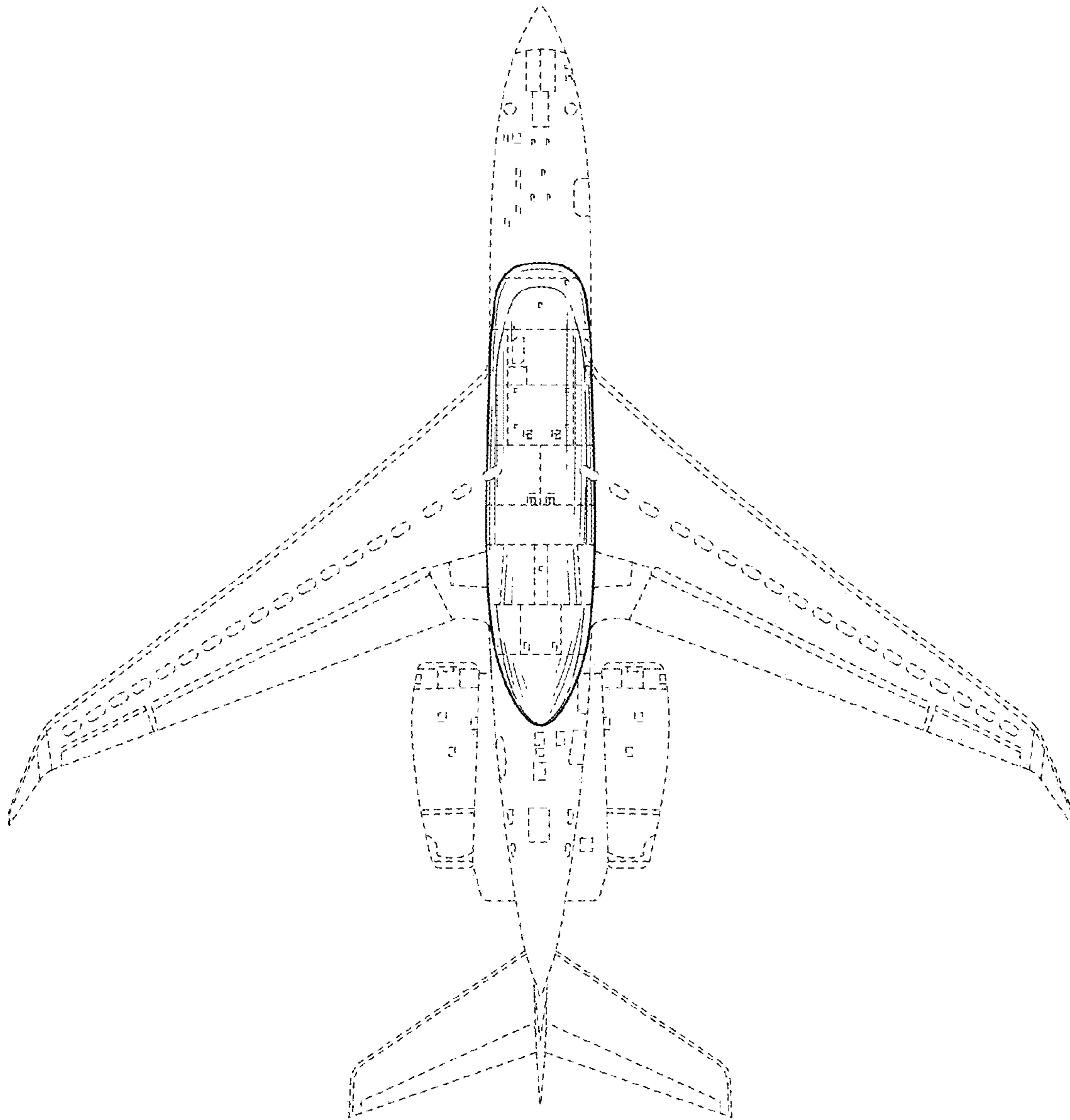

FIG. 6

UNITED STATES PATENT AND TRADEMARK OFFICE
CERTIFICATE OF CORRECTION

PATENT NO. : D758,950 S
APPLICATION NO. : 29/506146
DATED : June 14, 2016
INVENTOR(S) : James Scooler et al.

Page 1 of 1

It is certified that error appears in the above-identified patent and that said Letters Patent is hereby corrected as shown below:

On The Title Page, (72) Inventor “Guilherme Oliveria” should read --Guilherme Oliveira--

Signed and Sealed this
Twenty-ninth Day of November, 2016



Michelle K. Lee
Director of the United States Patent and Trademark Office