



US00D758938S

(12) **United States Design Patent**
Buffery

(10) **Patent No.:** **US D758,938 S**
(45) **Date of Patent:** **** Jun. 14, 2016**

(54) **VEHICLE COMPONENT**
(71) Applicant: **Jaguar Land Rover Limited**, Coventry (GB)
(72) Inventor: **Martin Buffery**, Coventry (GB)
(73) Assignee: **Jaguar Land Rover Limited** (GB)
(**) Term: **14 Years**
(21) Appl. No.: **29/515,285**
(22) Filed: **Jan. 21, 2015**
(30) **Foreign Application Priority Data**

Jul. 22, 2014 (EM) 002507285

(51) **LOC (10) Cl.** **12-16**
(52) **U.S. Cl.**
USPC **D12/195**
(58) **Field of Classification Search**
USPC D12/195, 193, 414, 190, 196; D10/46,
D10/98, 102-103; D8/302-303; D15/17, 28
CPC B60J 5/04; B60N 2/46; B60N 2/4693;
B60R 13/0243; B60R 13/02
See application file for complete search history.

(56) **References Cited**

U.S. PATENT DOCUMENTS

D285,785 S * 9/1986 Westall D12/183
D349,268 S * 8/1994 Jones D12/183

D350,322 S * 9/1994 Carson D12/183
D432,063 S * 10/2000 Sunday, Jr. D12/190
D488,584 S * 4/2004 Tsai D26/139
D496,618 S * 9/2004 Nakajima D12/195
8,317,248 B2 * 11/2012 Lange B60R 13/04
296/1.08
D718,198 S * 11/2014 Burgess D12/190
D742,797 S * 11/2015 Sugiura D12/195

* cited by examiner

Primary Examiner — Katrina A Betton

(74) *Attorney, Agent, or Firm* — Fishman Stewart PLLC

(57) **CLAIM**

The ornamental design for a vehicle component, as shown and described.

DESCRIPTION

FIG. 1 is a front perspective view of a vehicle component; FIG. 2 is a rear perspective view of a vehicle component; FIG. 3 is a front view of a vehicle component; FIG. 4 is a rear view of a vehicle component; FIG. 5 is a left perspective side view of a vehicle component; FIG. 6 is a right perspective side view of a vehicle component; FIG. 7 is a top view of a vehicle component; and, FIG. 8 is a supplemental rear perspective view of vehicle component in the installed position on vehicle. Portions of FIG. 8 shown in diagonal lines are for illustrative purposes only and form no part of the claimed design.

1 Claim, 4 Drawing Sheets

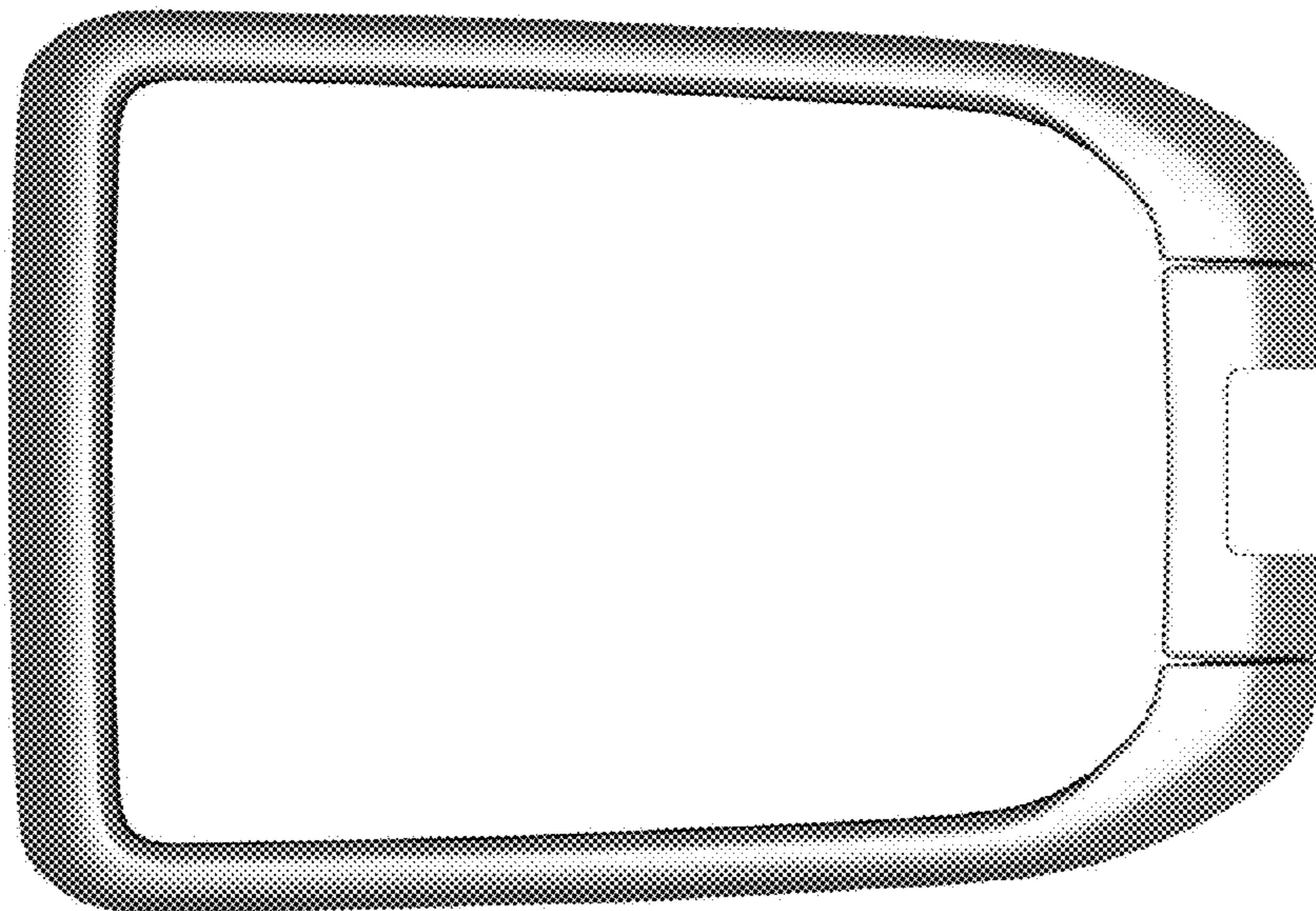

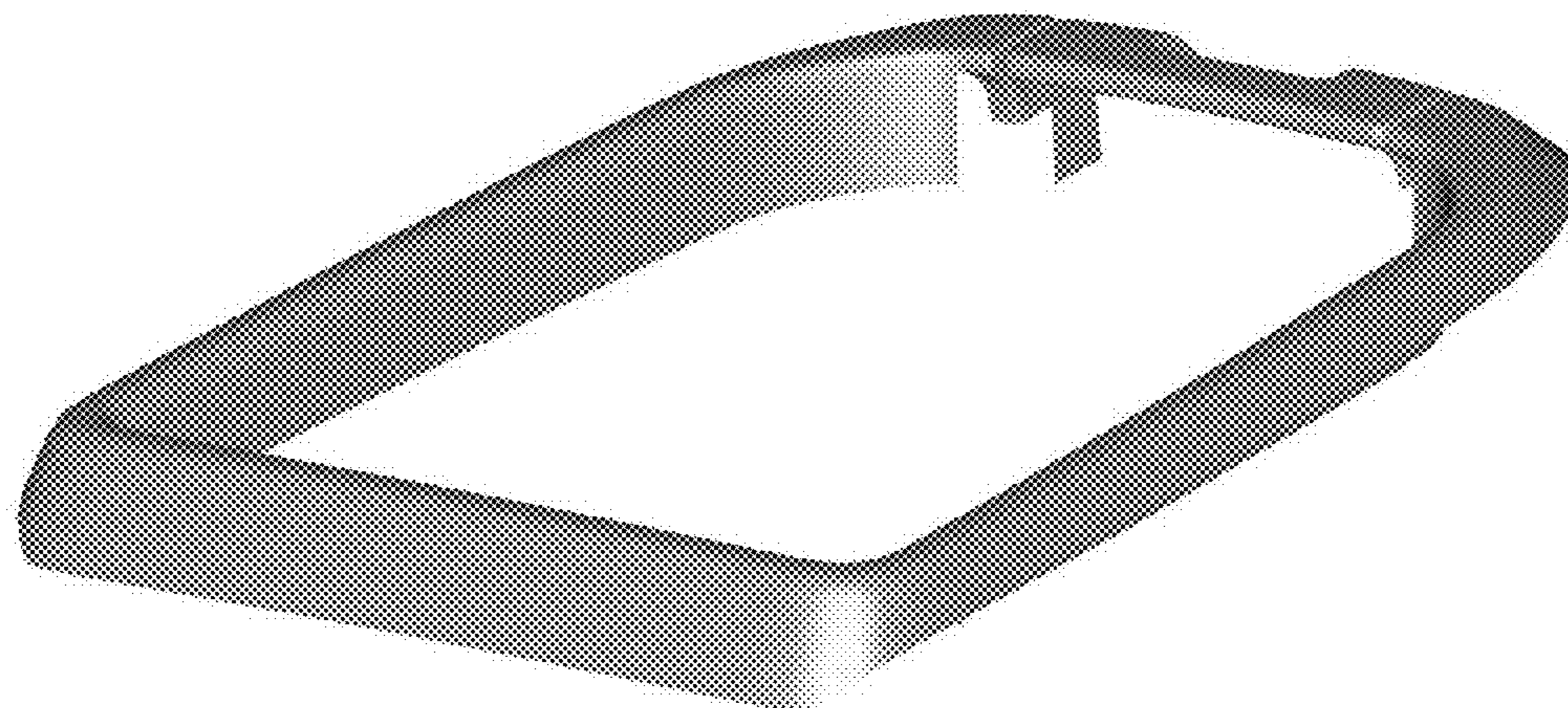

FIG. 1

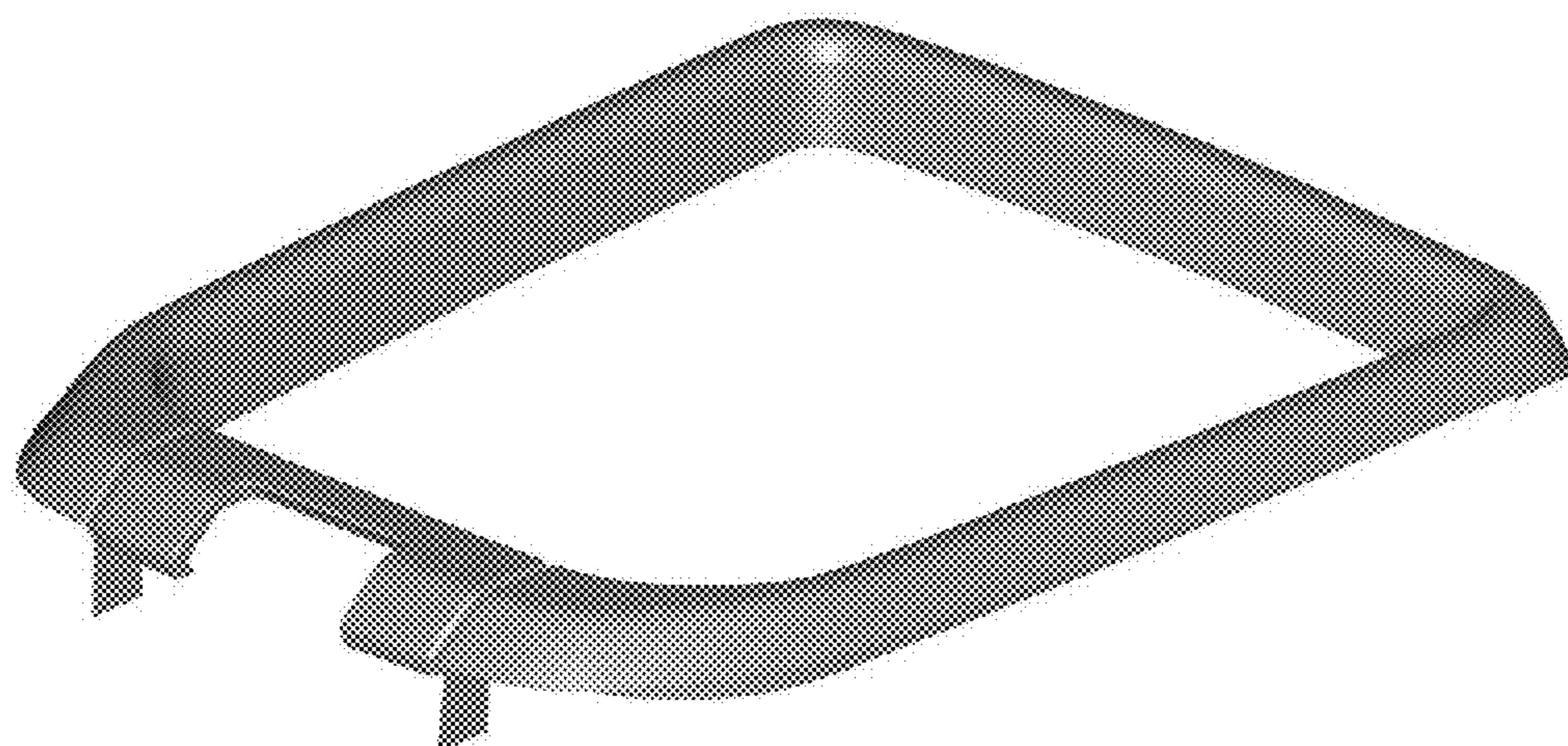

FIG. 2

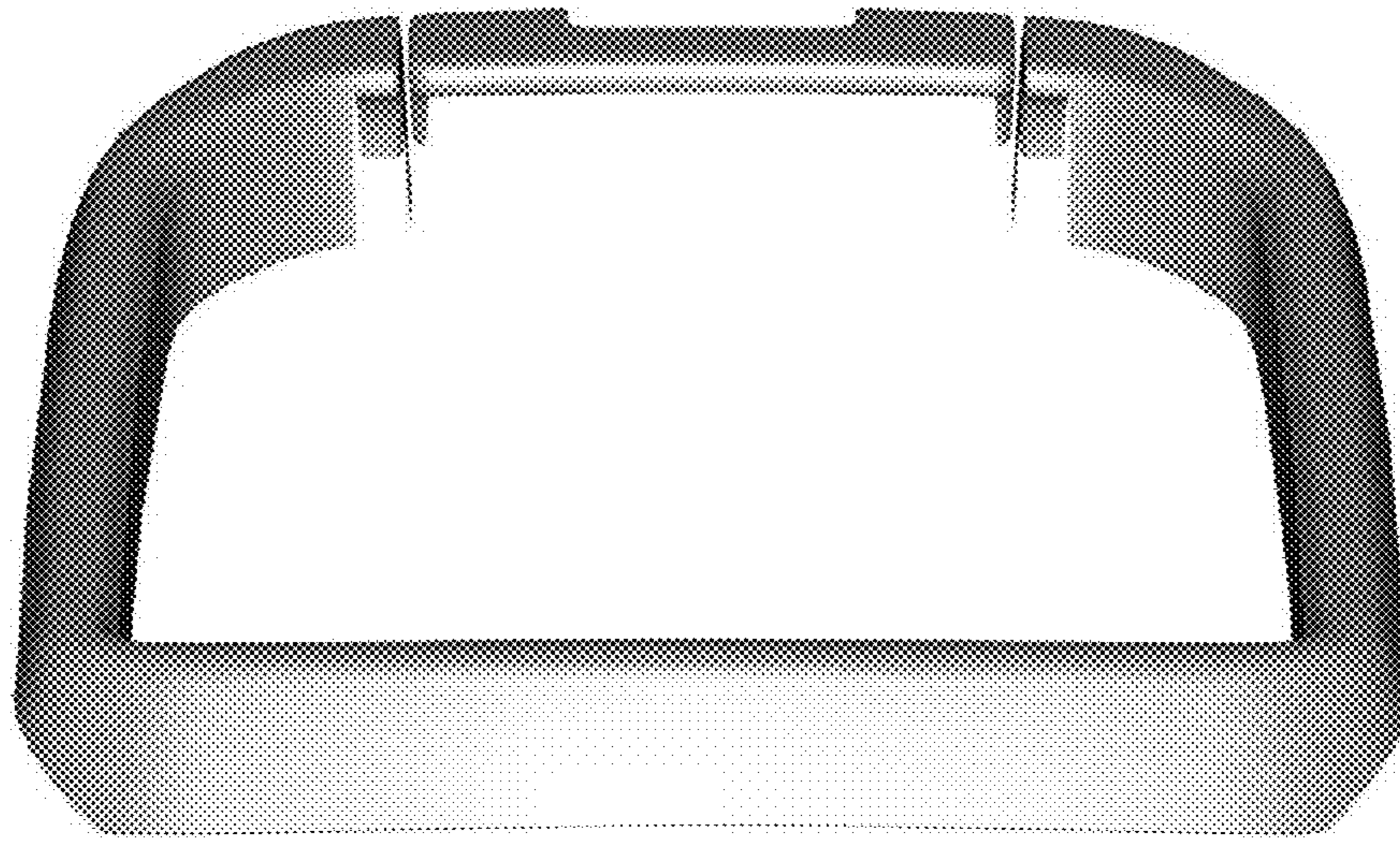

FIG. 3

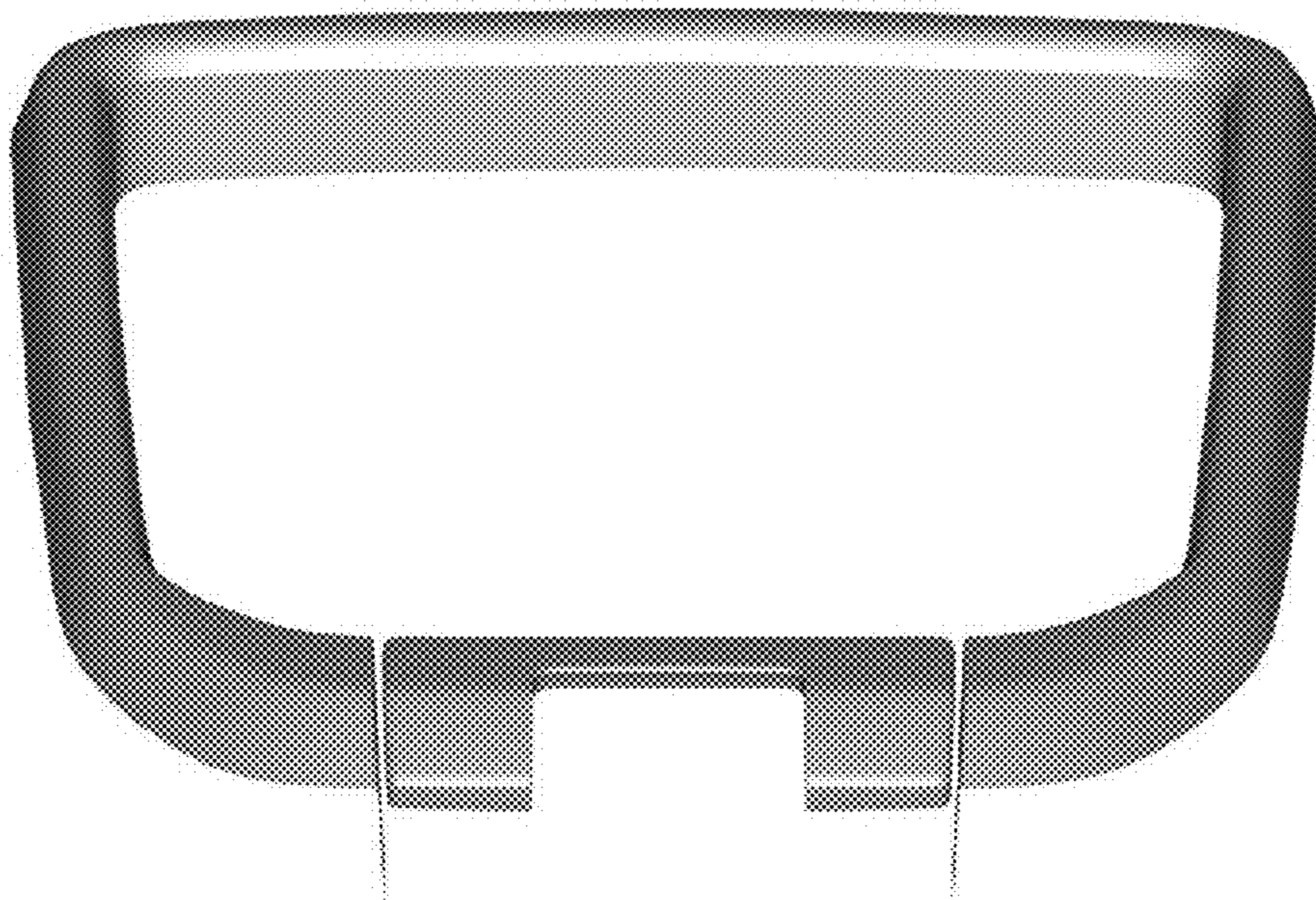

FIG. 4

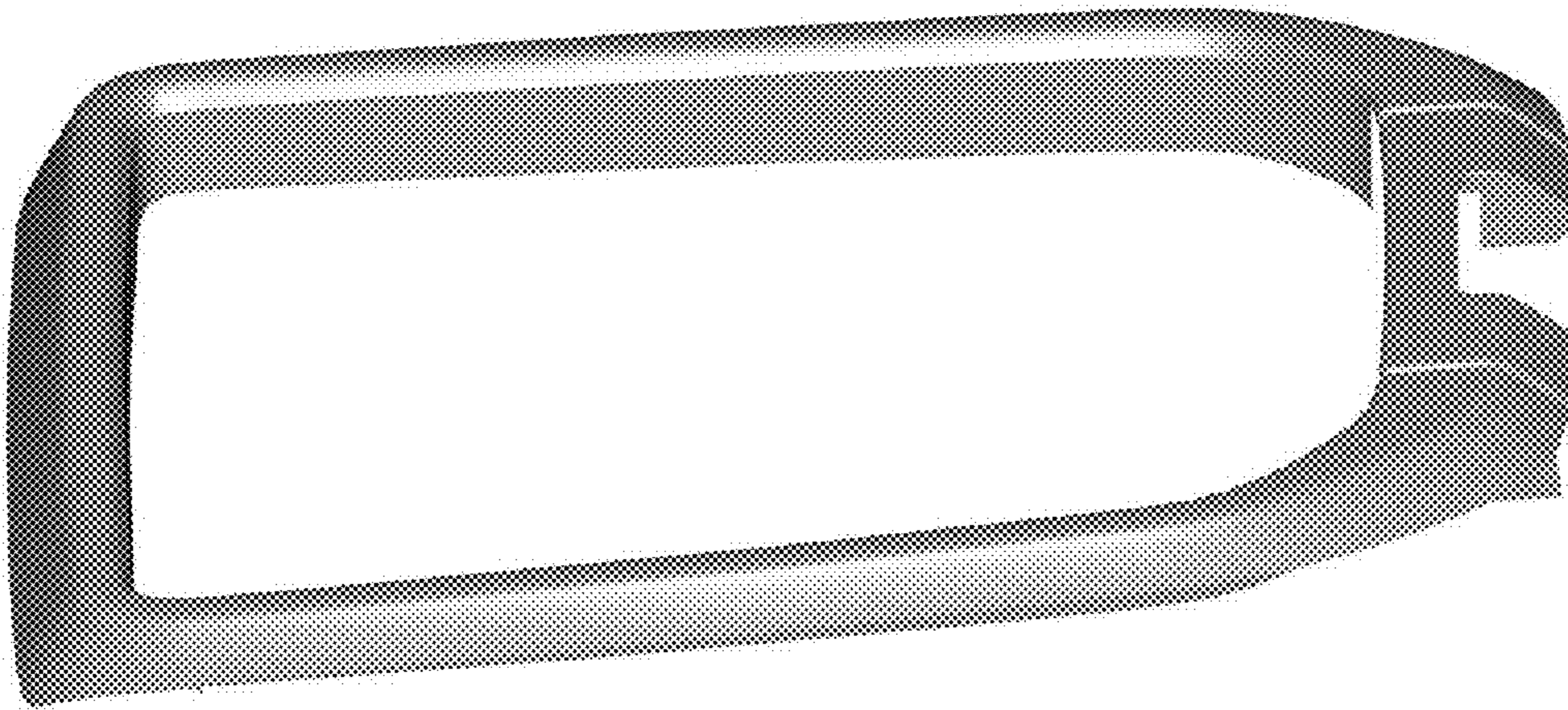

FIG. 5

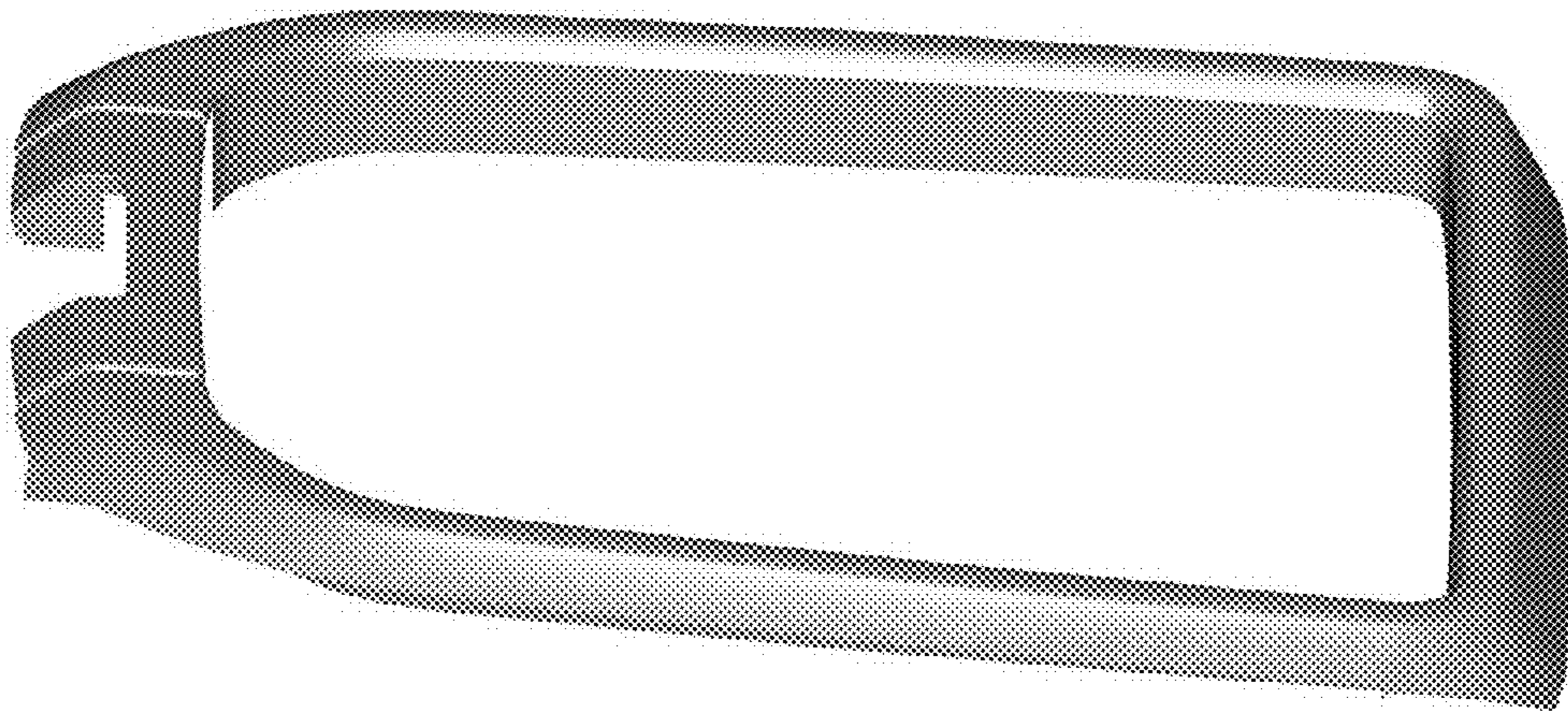

FIG. 6

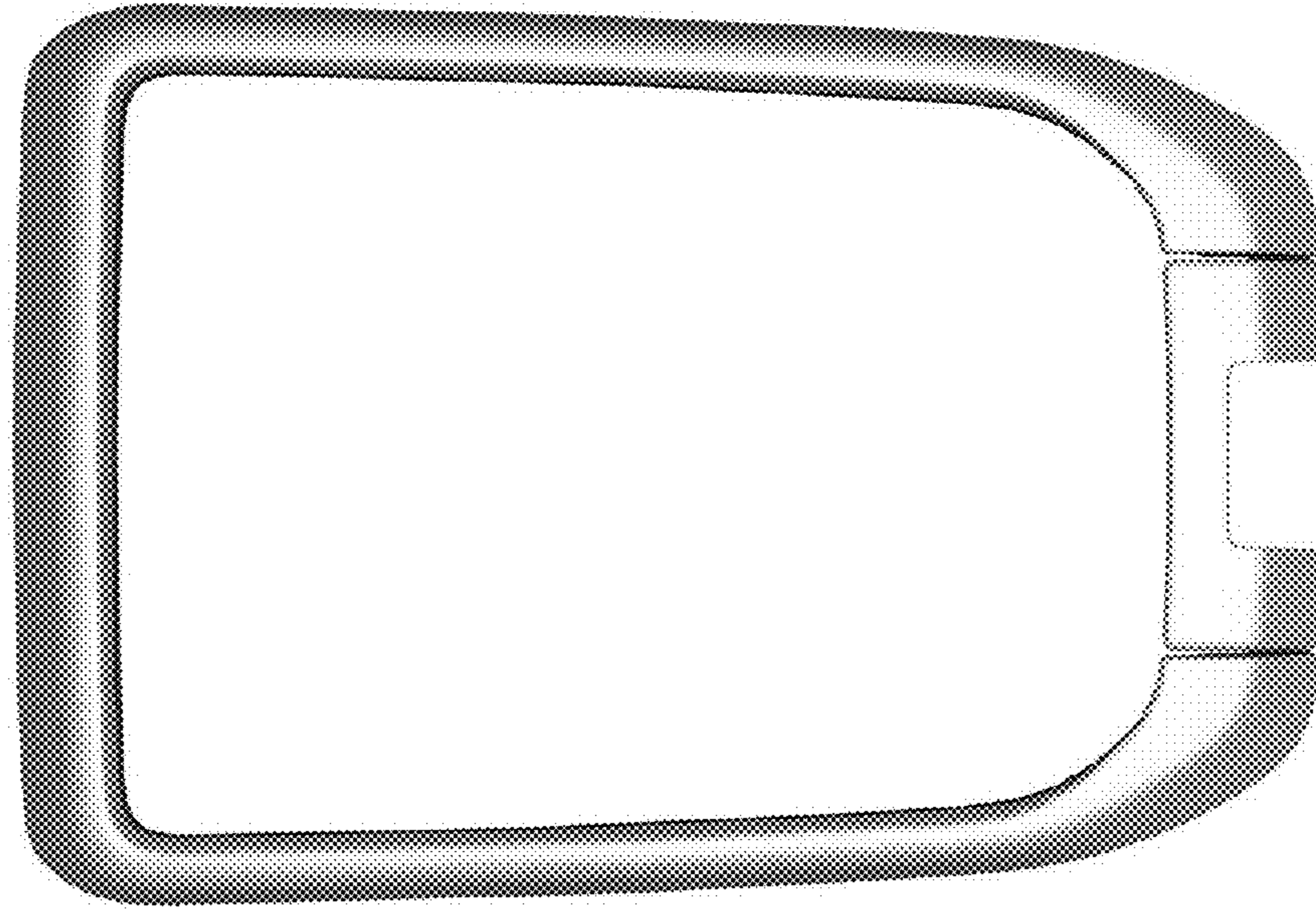

FIG. 7

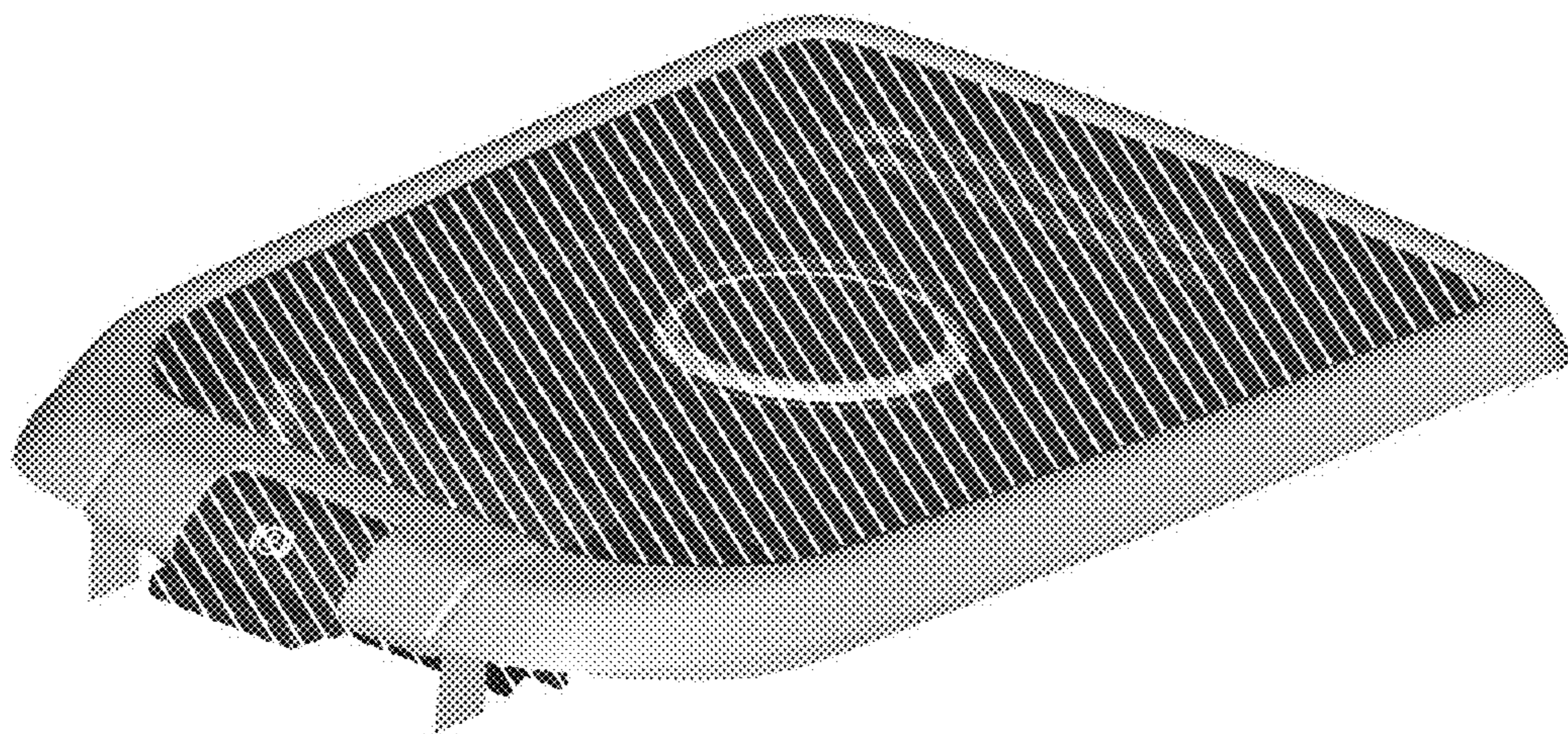

FIG. 8