



US00D758934S

(12) **United States Design Patent**
Gee

(10) **Patent No.:** **US D758,934 S**
(45) **Date of Patent:** **** Jun. 14, 2016**

- (54) **DIAMOND SHAPED FENDER**
- (71) Applicant: **John Alden Gee**, Eagle Mountain, UT (US)
- (72) Inventor: **John Alden Gee**, Eagle Mountain, UT (US)
- (**) Term: **15 Years**
- (21) Appl. No.: **29/527,998**
- (22) Filed: **May 23, 2015**
- (51) **LOC (10) Cl.** **12-08**
- (52) **U.S. Cl.**
USPC **D12/181**
- (58) **Field of Classification Search**
USPC D12/181, 191, 196, 400, 190, 88
CPC B60R 13/04; B60R 13/02
See application file for complete search history.

- D710,772 S * 8/2014 Maiorana D12/181
- D727,810 S * 4/2015 Beaven D12/181
- D743,862 S * 11/2015 Hodges D12/181

* cited by examiner

Primary Examiner — Katrina A Betton

(57) **CLAIM**

The ornamental design for a diamond shaped fender, as shown and described.

DESCRIPTION

FIG. 1 is a front perspective view showing my new design; FIG. 2 is a rear perspective view thereof; FIG. 3 is a left side elevational view showing my new design, the right side being a mirror image; FIG. 4 is a top side elevational view thereof; FIG. 5 is a bottom side elevational view thereof; FIG. 6 is a front elevational view thereof; FIG. 7 is a rear elevational view thereof; FIG. 8 is a front perspective view shown in relation to a wheel. The wheel is shown in broken lines and forms no part of the claimed design; and, FIG. 9 is a back perspective view shown in relation to a mounting block. The mounting block is shown in broken lines and forms no part of the claimed design.

1 Claim, 3 Drawing Sheets

(56) **References Cited**

U.S. PATENT DOCUMENTS

- D169,459 S * 4/1953 Semensohn D11/74
- D261,448 S * 10/1981 Liebscher D11/81
- D400,837 S * 11/1998 Pitts D12/181
- D562,745 S * 2/2008 Schowalter D12/179
- D570,945 S * 6/2008 Stagnaro D21/778
- D597,456 S * 8/2009 Kosaka D12/181
- D683,678 S * 6/2013 Willard D12/181

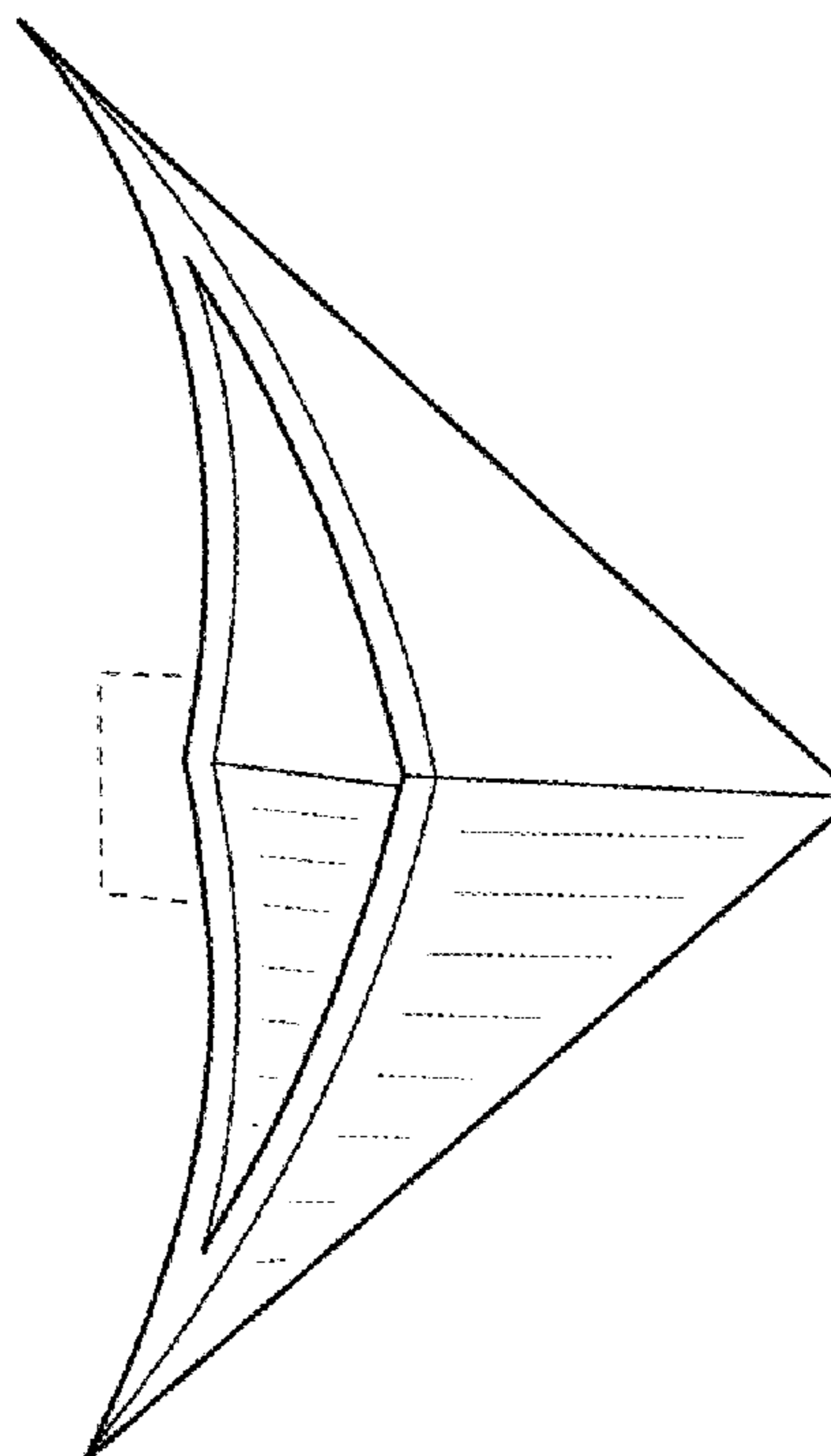

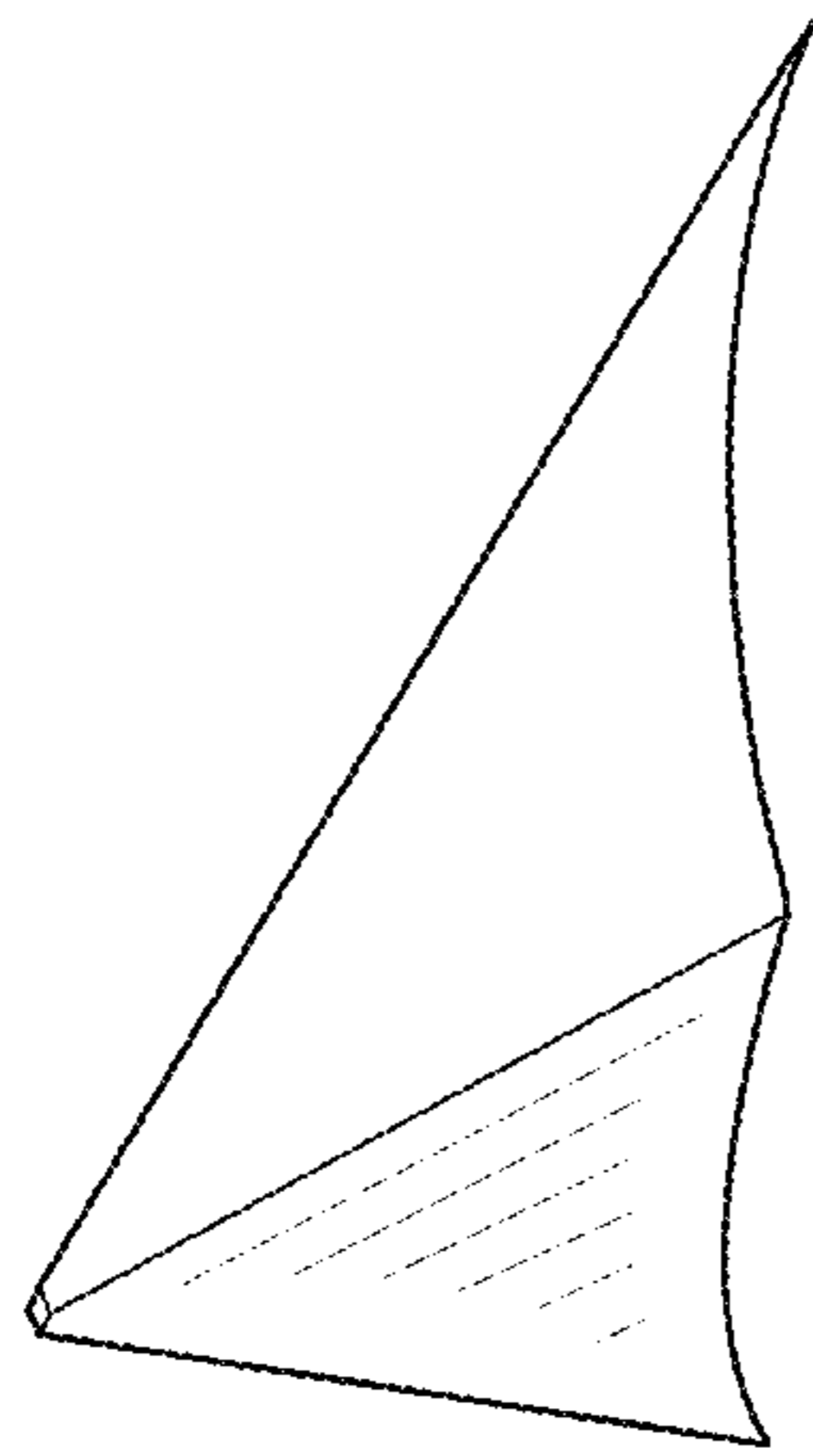

FIG. 1

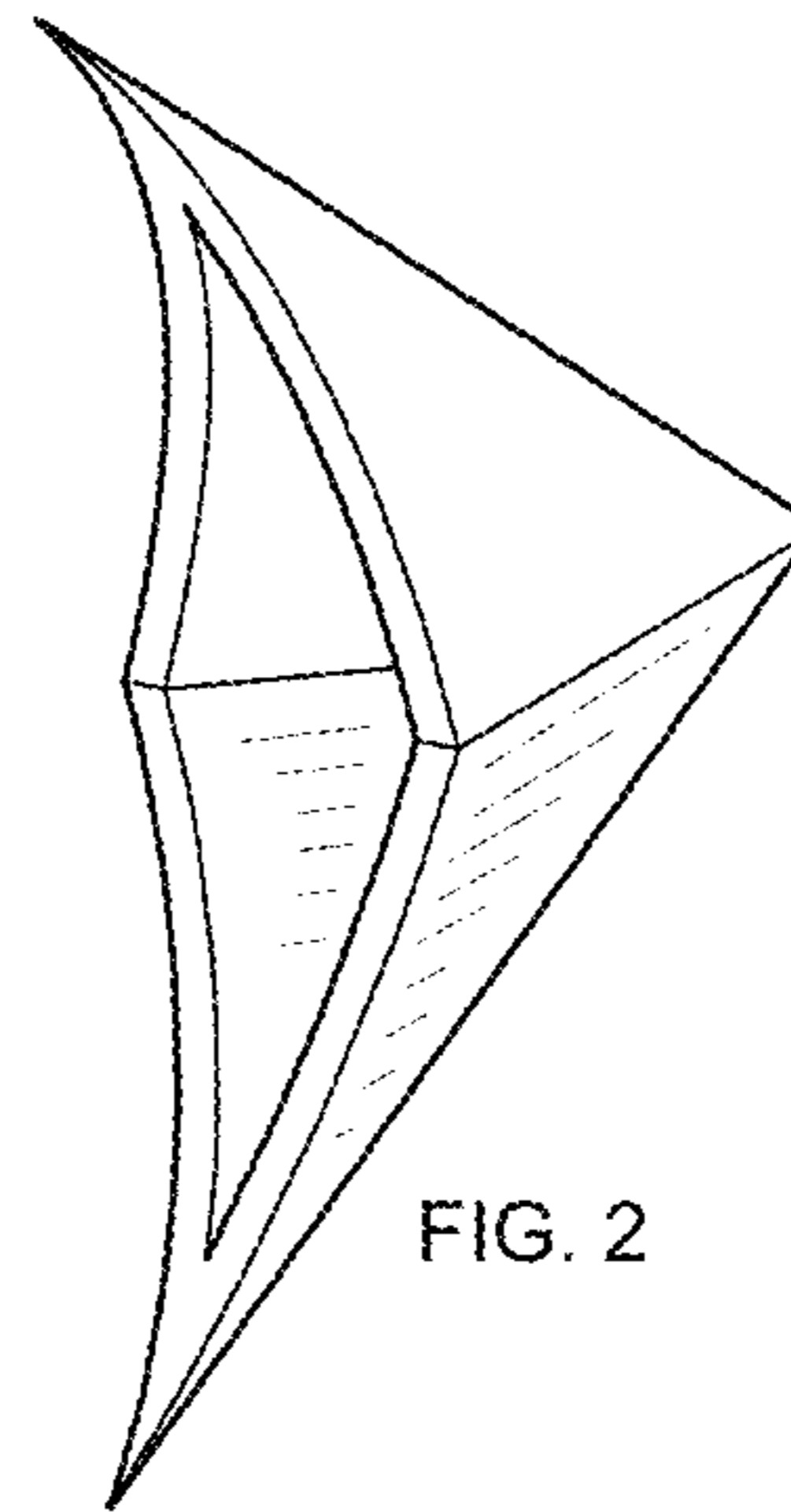

FIG. 2

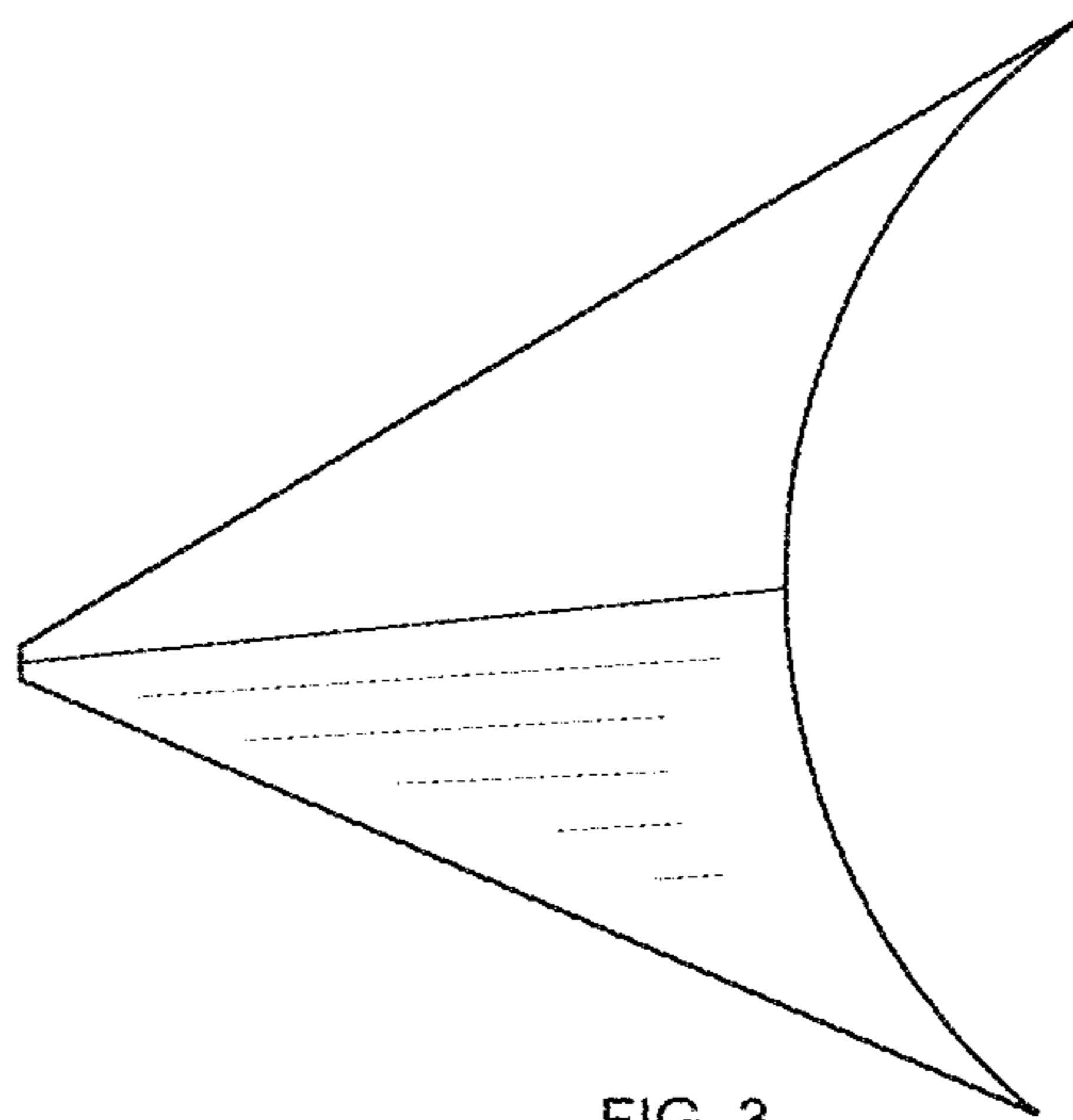

FIG. 3

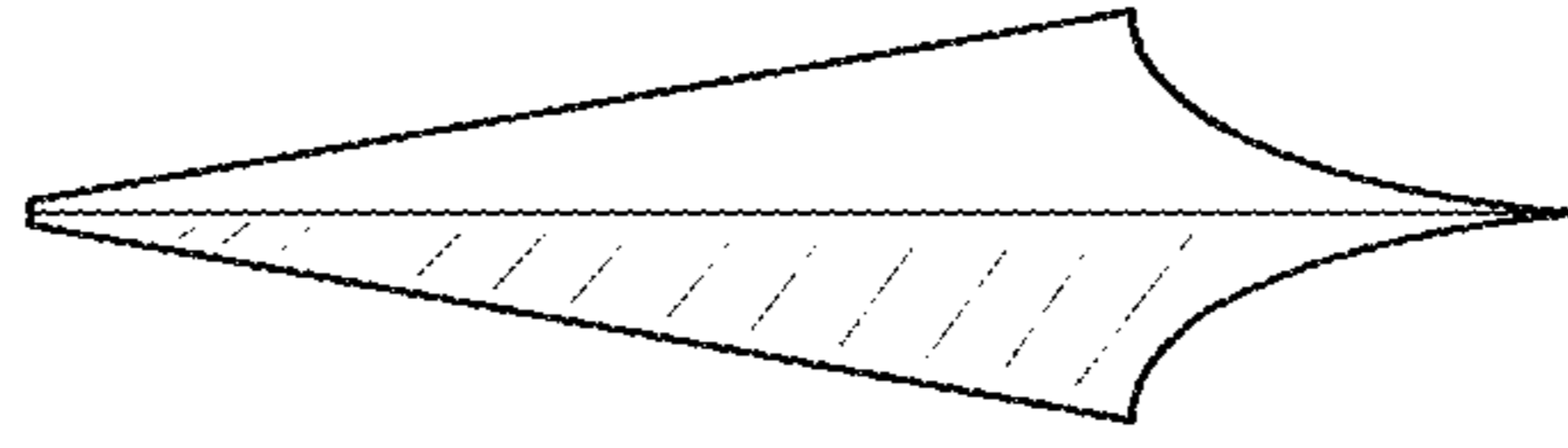

FIG. 4

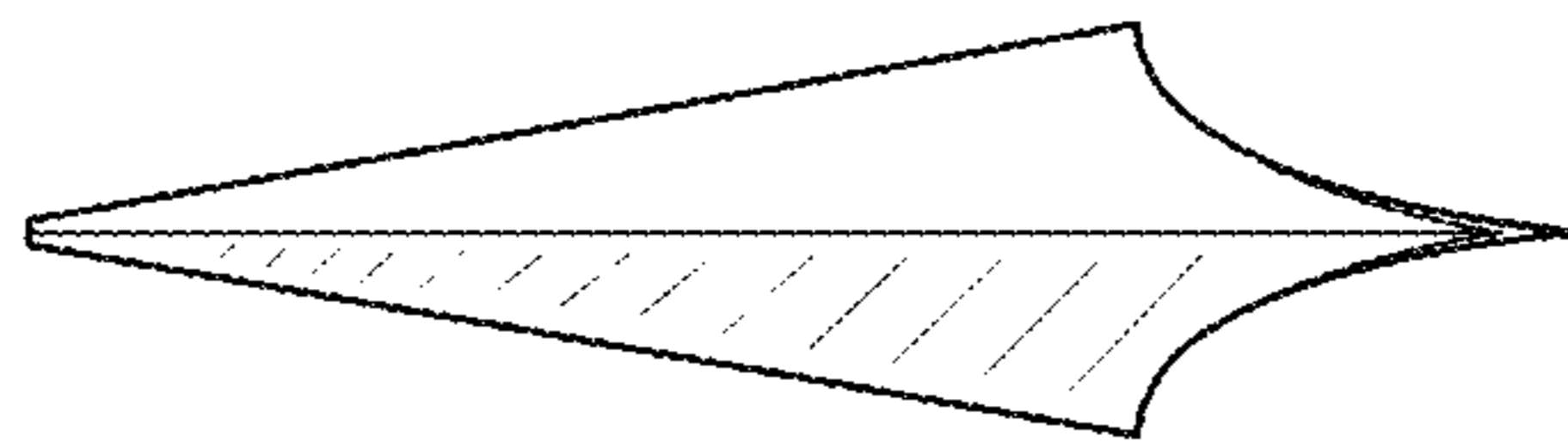

FIG. 5

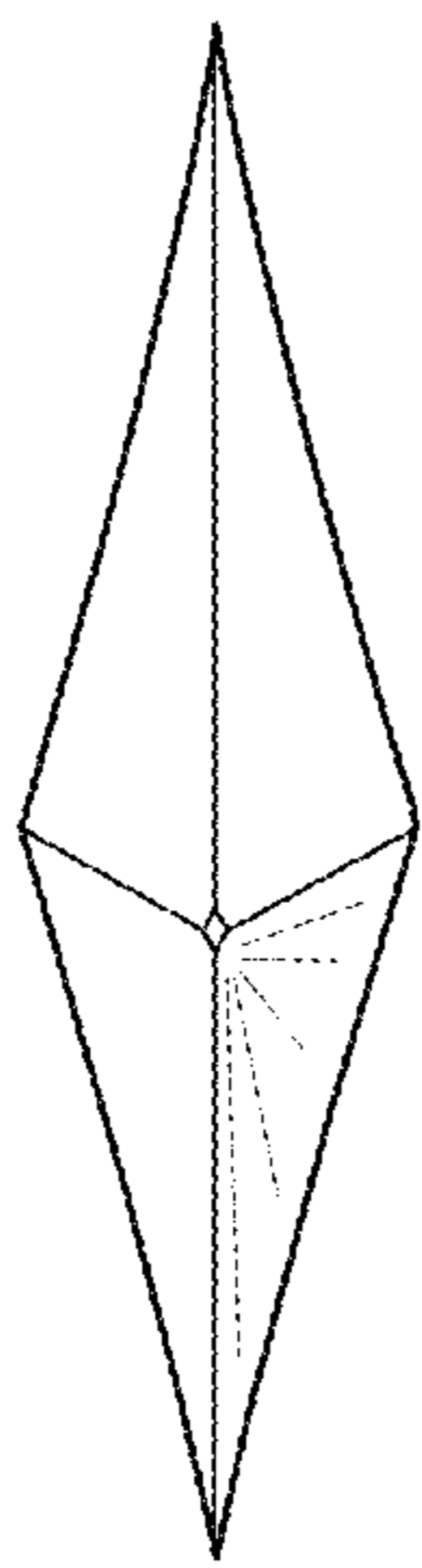

FIG. 6

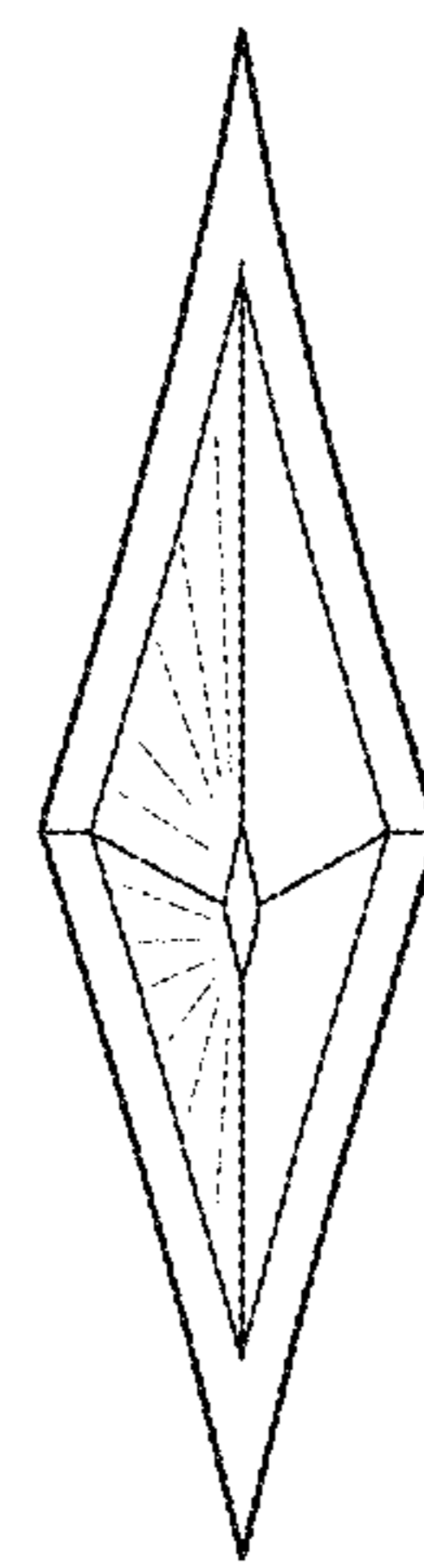

FIG. 7

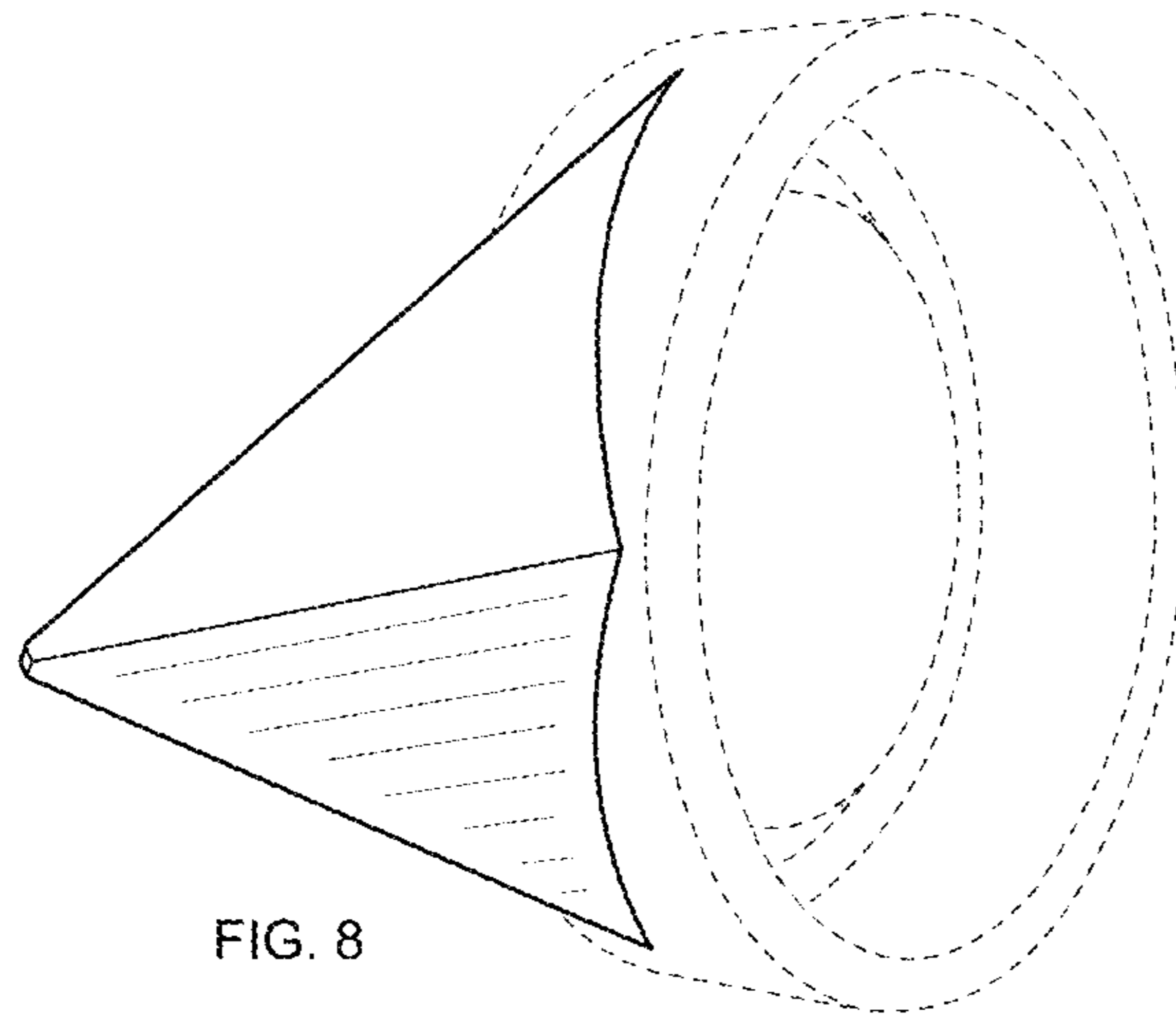

FIG. 8

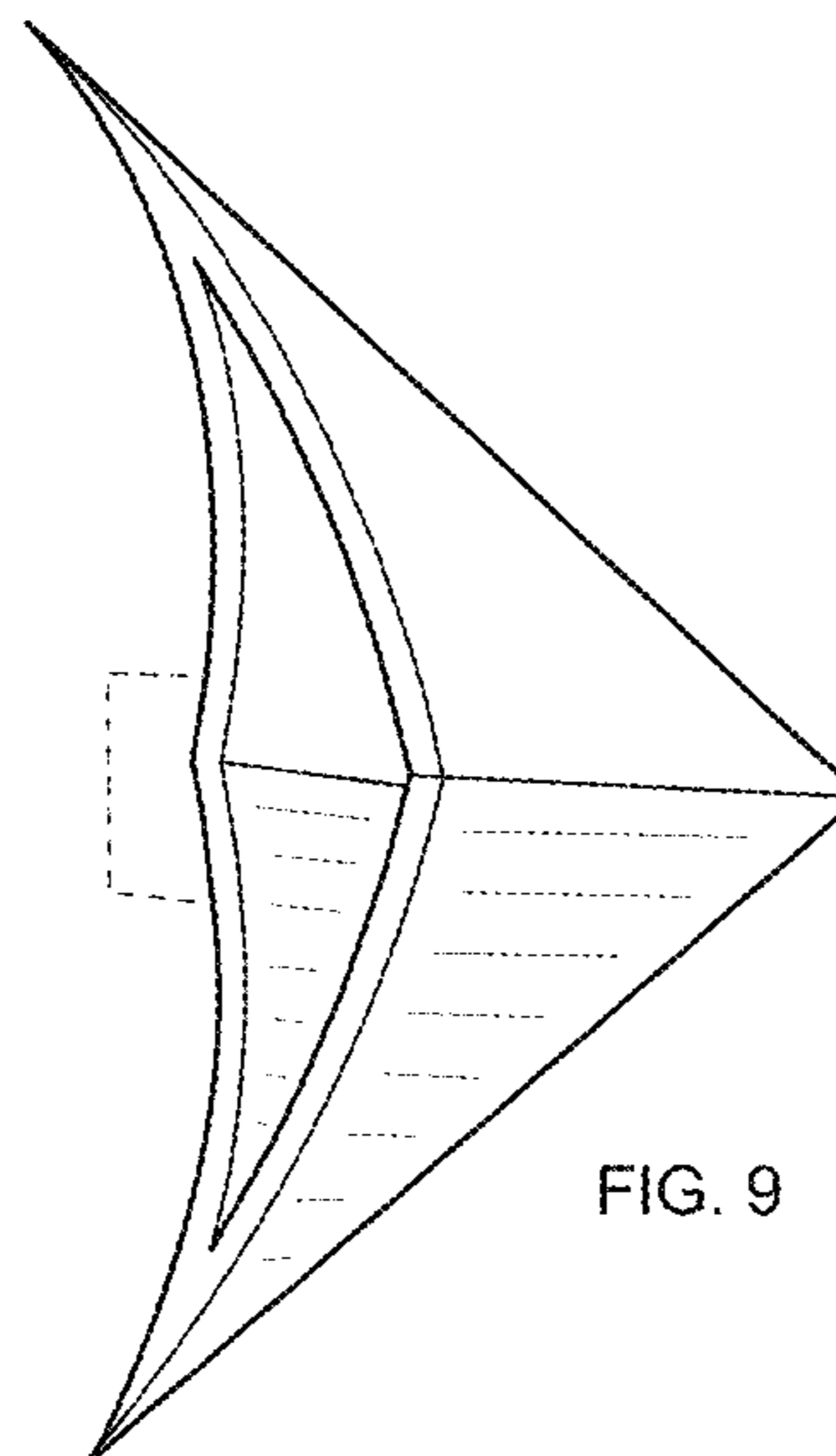

FIG. 9