



US00D758921S

(12) **United States Design Patent**
Hatton

(10) **Patent No.:** **US D758,921 S**
(45) **Date of Patent:** **** Jun. 14, 2016**

(54) **VEHICLE**

(71) Applicant: **Jaguar Land Rover Limited**, Coventry (GB)

(72) Inventor: **Adam Hatton**, Coventry (GB)

(73) Assignee: **Jaguar Land Rover Limited** (GB)

(**) Term: **14 Years**

(21) Appl. No.: **29/501,369**

(22) Filed: **Sep. 3, 2014**

(30) **Foreign Application Priority Data**

Mar. 4, 2014 (EM) 002417659

(51) **LOC (10) CL.** **12-08**

(52) **U.S. CL.**
USPC **D12/92**

(58) **Field of Classification Search**
USPC D12/86, 90-92; D21/421, 433, 434;
296/181.1, 181.5
CPC B62D 35/00; B62D 25/00; B62D 25/06;
B62D 33/00

See application file for complete search history.

(56) **References Cited**

U.S. PATENT DOCUMENTS

D704,101 S *	5/2014	Beaven	D12/92
D711,287 S *	8/2014	Butterworth	D12/92
D711,288 S *	8/2014	Butterworth	D12/92
D718,662 S *	12/2014	Ishizuka	D12/92
D719,878 S *	12/2014	Webber	D12/92
D726,074 S *	4/2015	Beaven	D12/92
D740,177 S *	10/2015	Callum	D12/92

* cited by examiner

Primary Examiner — Melody N Brown

(74) *Attorney, Agent, or Firm* — Fishman Stewart PLLC

(57) **CLAIM**

The ornamental design for a vehicle, as shown and described.

DESCRIPTION

FIG. 1 is a front perspective view of a first embodiment of a vehicle with a glass roof panel;

FIG. 2 is a rear perspective view of a first embodiment of a vehicle with a glass roof panel;

FIG. 3 is a left side view of a first embodiment of a vehicle with a glass roof panel;

FIG. 4 is a right side view of a first embodiment of a vehicle with a glass roof panel;

FIG. 5 is a front view of a first embodiment of a vehicle with a glass roof panel;

FIG. 6 is a rear view of a first embodiment of a vehicle with a glass roof panel;

FIG. 7 is a top view of vehicle a first embodiment of a vehicle with a glass roof panel;

FIG. 8 is a front perspective view of a second embodiment of a vehicle without a glass roof panel;

FIG. 9 is a rear perspective view of a second embodiment of a vehicle without a glass roof panel;

FIG. 10 is a left side view of a second embodiment of a vehicle without a glass roof panel;

FIG. 11 is a right side view of a second embodiment of a vehicle without a glass roof panel;

FIG. 12 is a front view of a second embodiment of a vehicle without a glass roof panel;

FIG. 13 is a rear view of a second embodiment of a vehicle without a glass roof panel;

FIG. 14 is a top view of vehicle a second embodiment of a vehicle without a glass roof panel;

FIG. 15 is front perspective view of a third embodiment of a vehicle with a glass roof panel;

FIG. 16 is rear perspective view of a third embodiment of a vehicle with a glass roof panel;

FIG. 17 is a left side view of a third embodiment of a vehicle with a glass roof panel;

FIG. 18 is a right side view of a third embodiment of a vehicle with a glass roof panel;

FIG. 19 is a front view of a third embodiment of a vehicle with a glass roof panel;



FIG. 20 is a rear view of a third embodiment of a vehicle with a glass roof panel;

FIG. 21 is a top view of vehicle a third embodiment of a vehicle with a glass roof panel;

FIG. 22 is a front perspective view of a fourth embodiment of a vehicle without a glass roof panel;

FIG. 23 is a rear perspective view of a fourth embodiment of a vehicle without a glass roof panel;

FIG. 24 is a left side view of a fourth embodiment of a vehicle without a glass roof panel;

FIG. 25 is a right side view of a fourth embodiment of a vehicle without a glass roof panel;

FIG. 26 is a front view of a fourth embodiment of a vehicle without a glass roof panel;

FIG. 27 is a rear view of a fourth embodiment of a vehicle without a glass roof panel; and,

FIG. 28 is a top view of vehicle a fourth embodiment of a vehicle without a glass roof panel.

Portions of the figures shown in broken lines are for illustrative purposes only and form no part of the claimed design.

1 Claim, 20 Drawing Sheets



FIG. 1

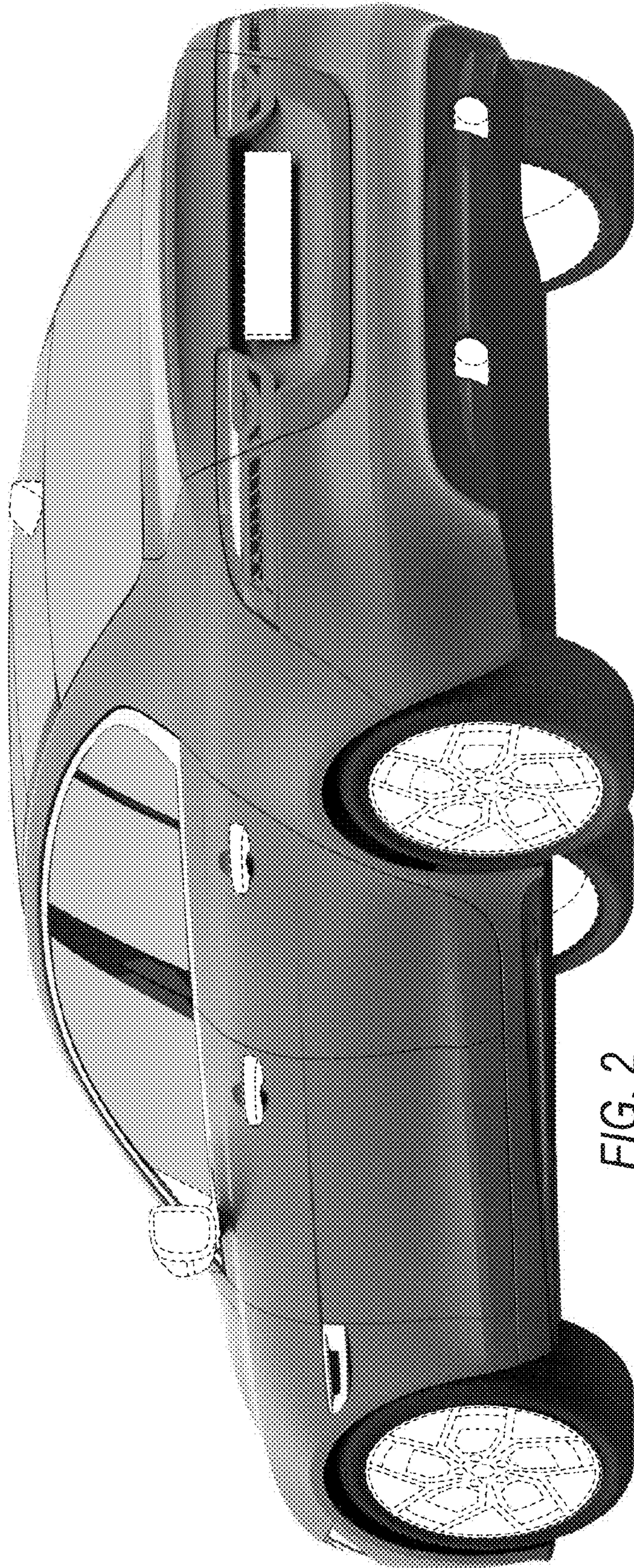

FIG. 2

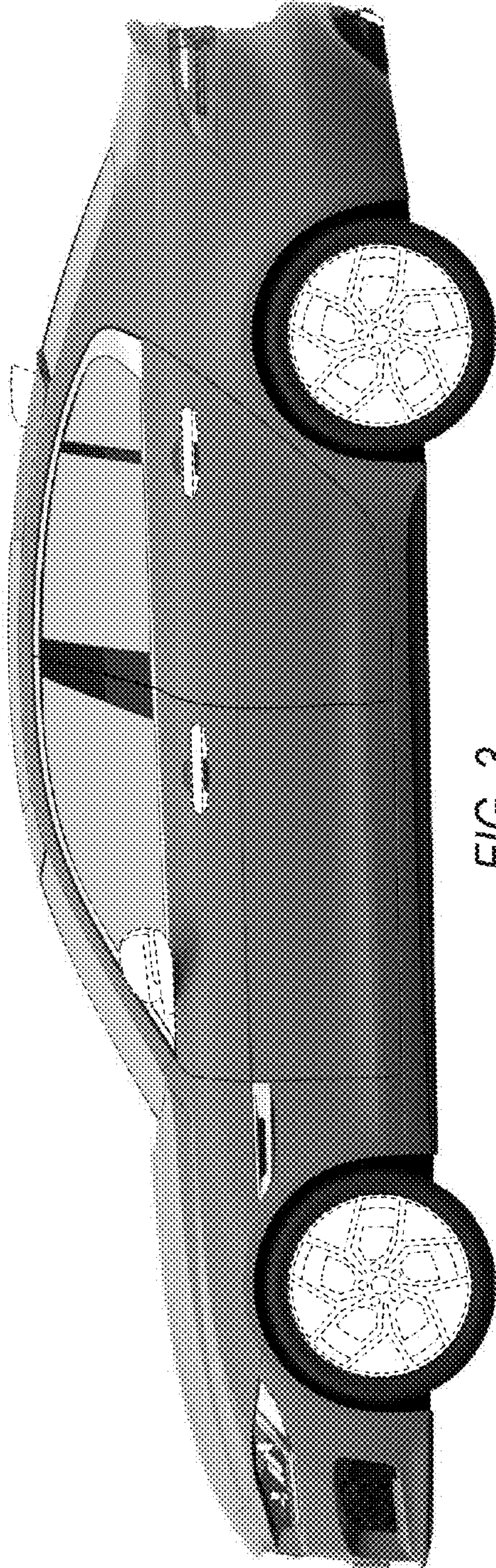

FIG. 3

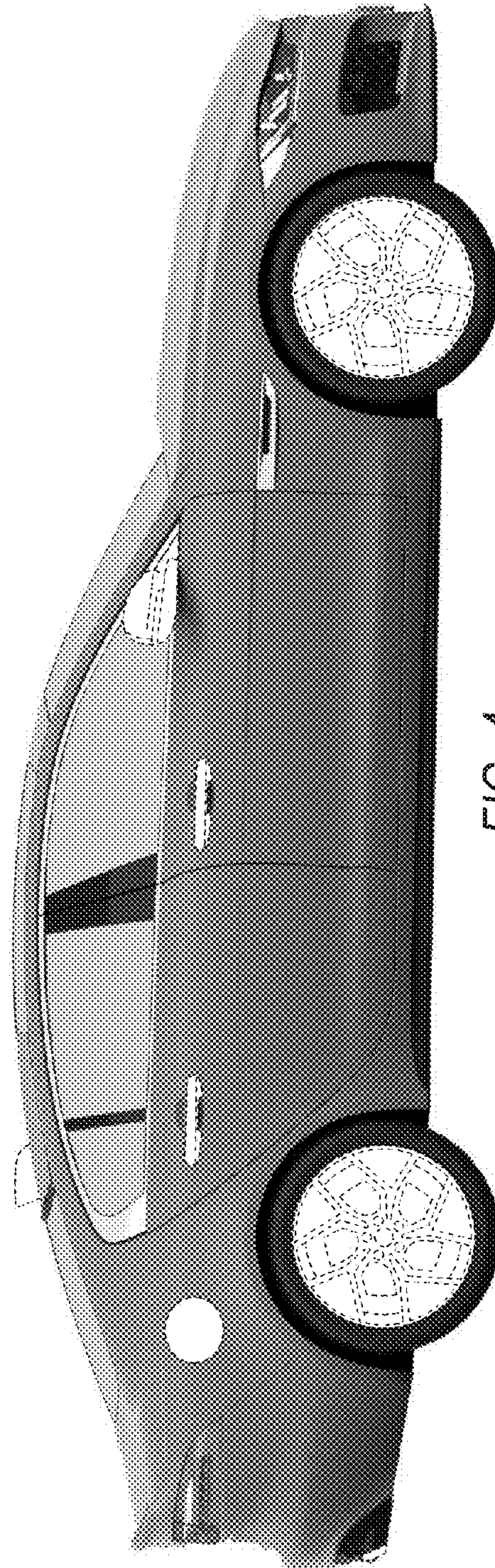

FIG. 4



FIG. 5



FIG. 6



FIG. 7



FIG. 8

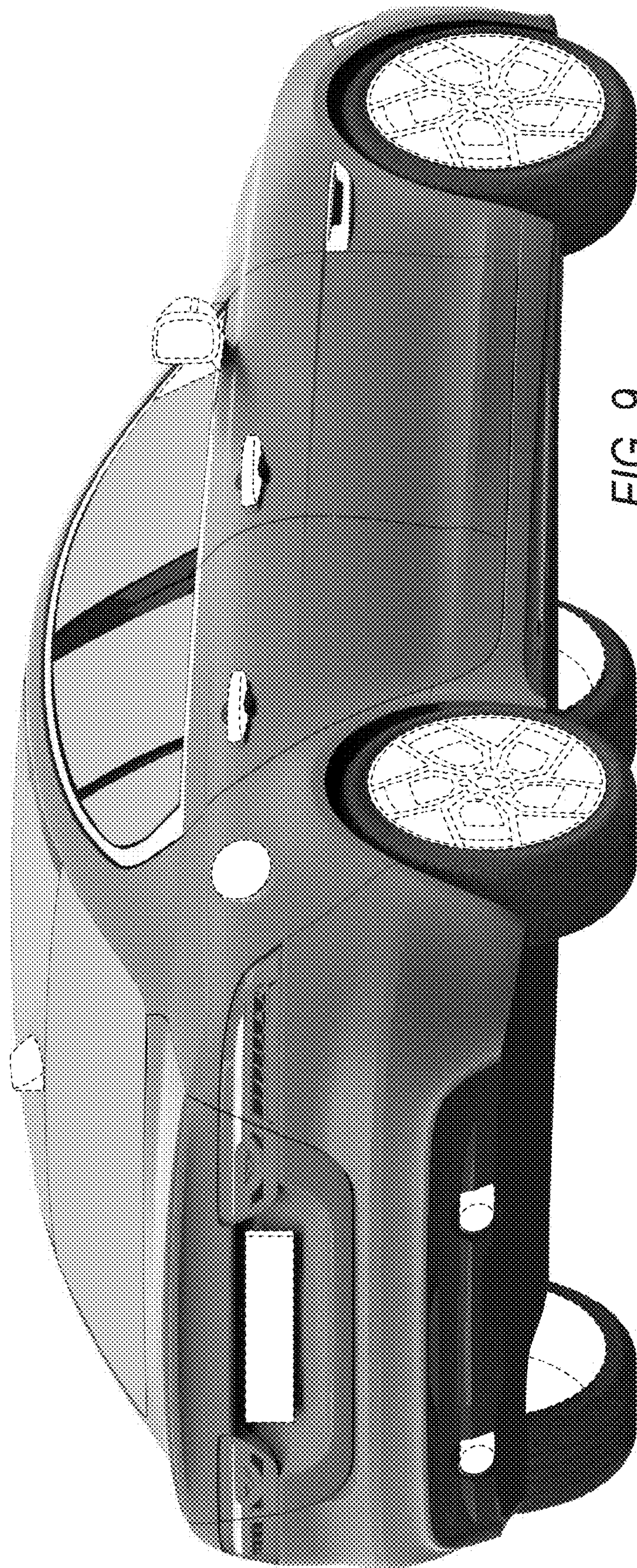

FIG. 9

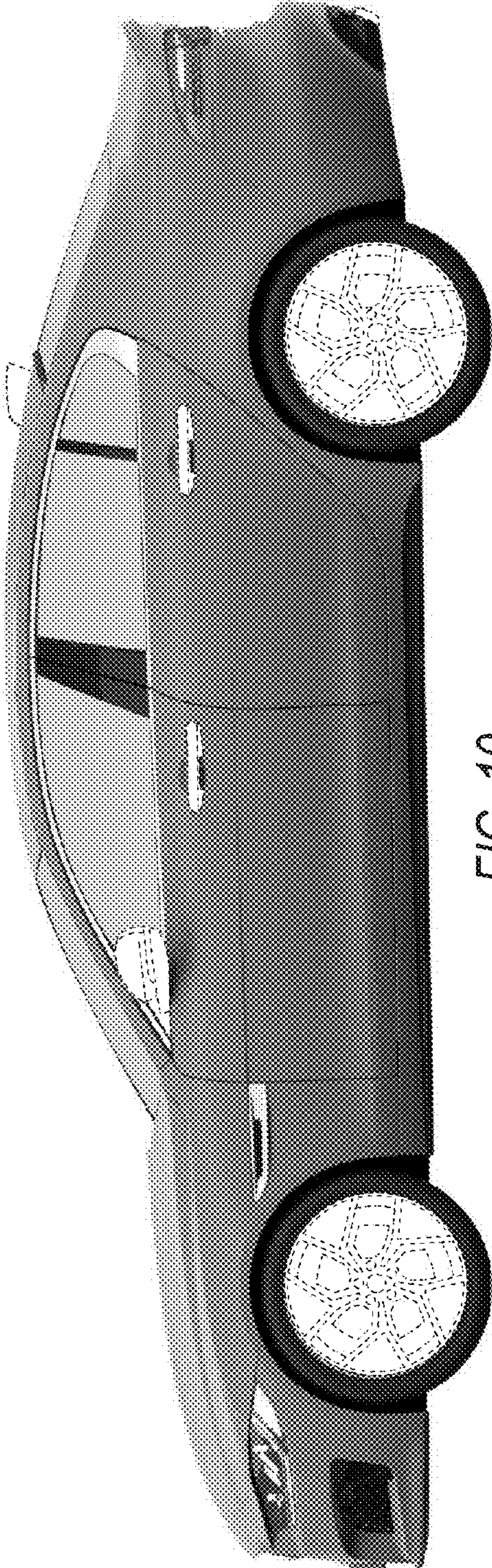

FIG. 10

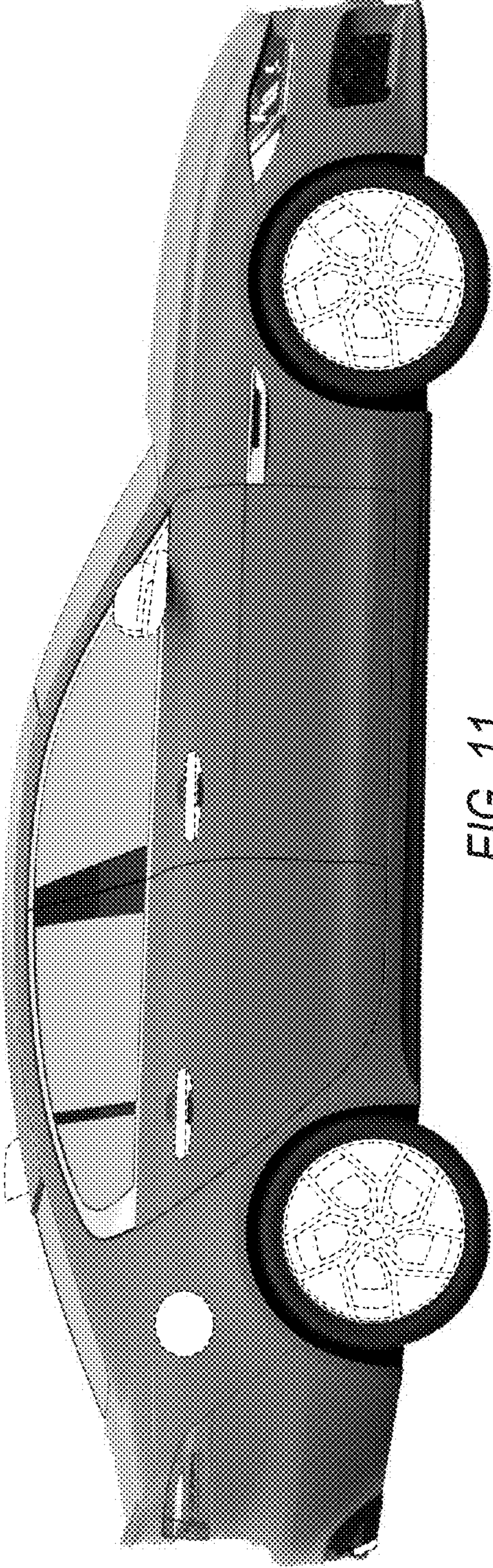

FIG. 11



FIG. 12



FIG. 13

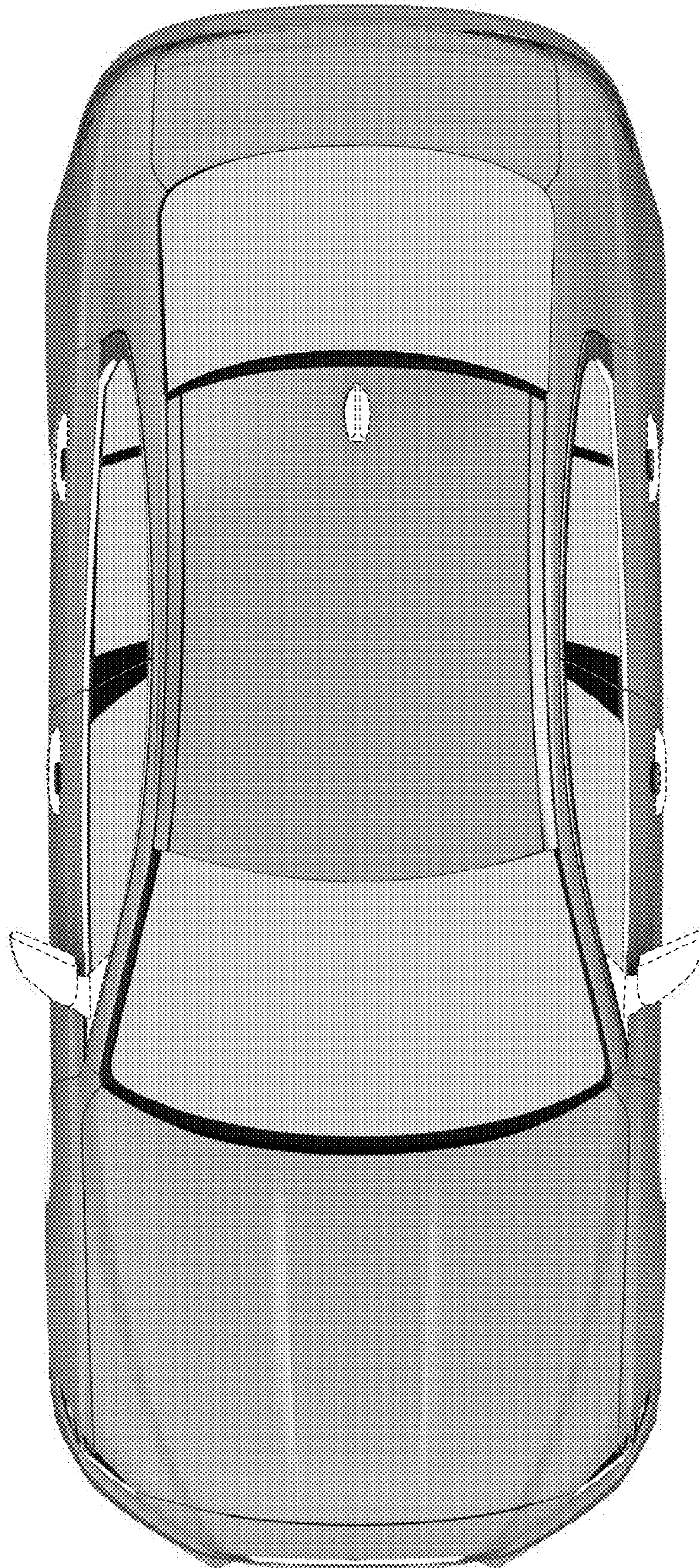

FIG. 14



FIG. 15

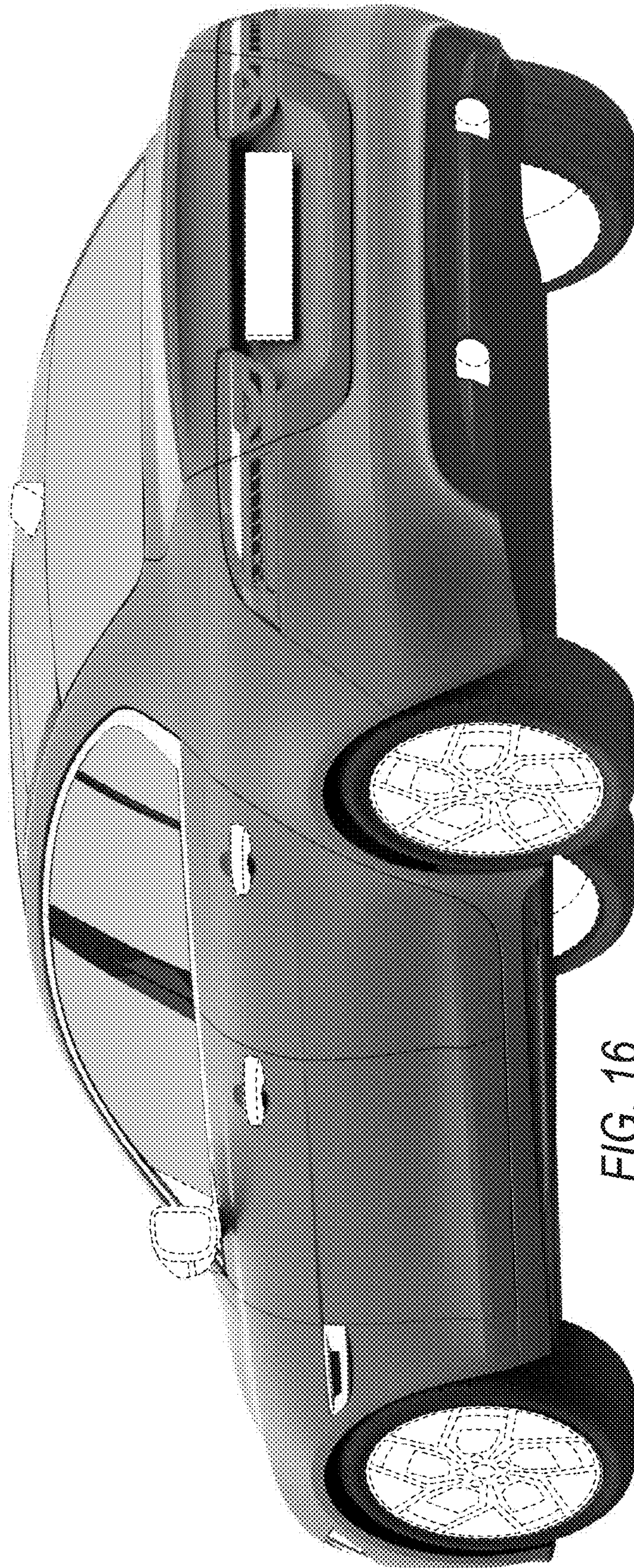

FIG. 16

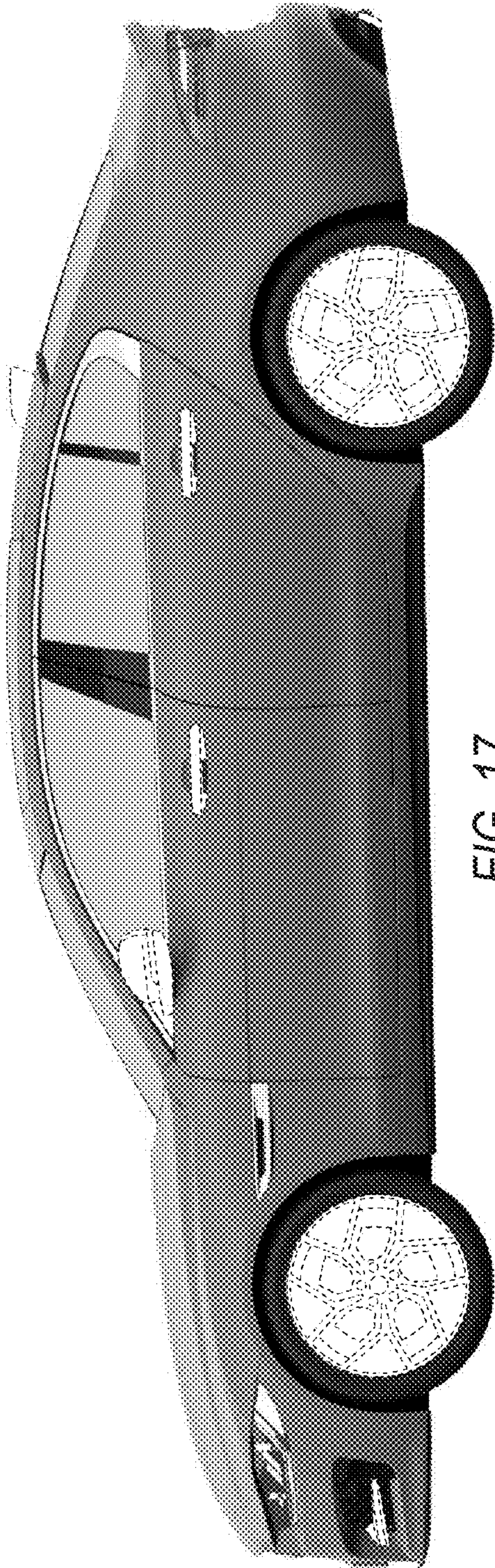

FIG. 17

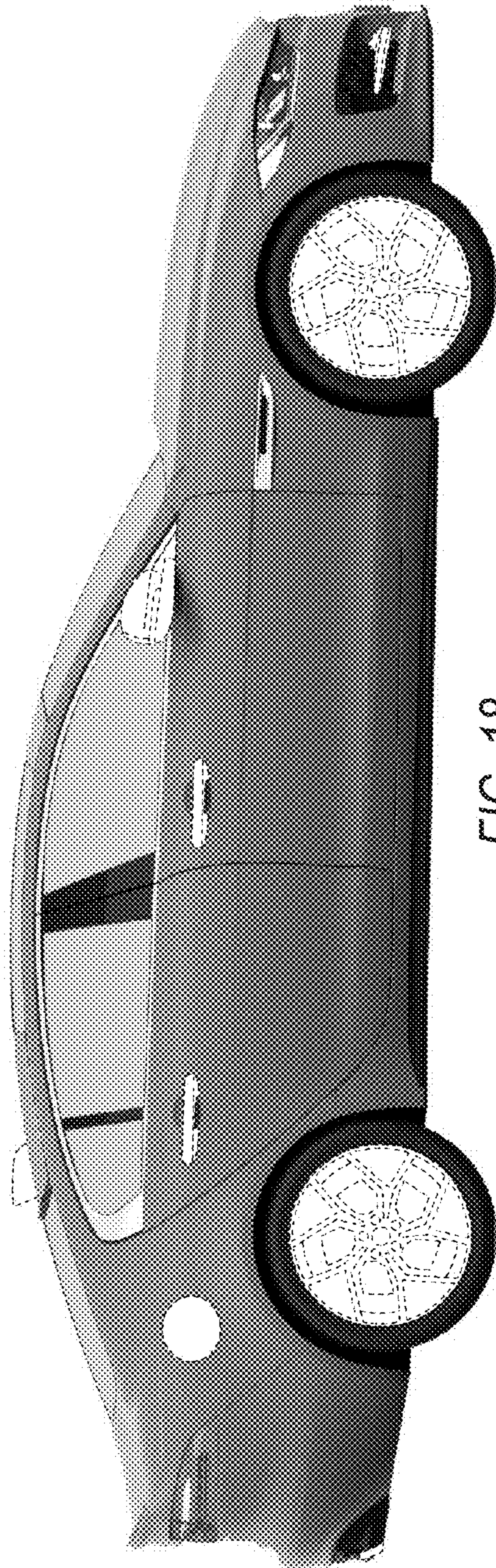

FIG. 18



FIG. 19



FIG. 20

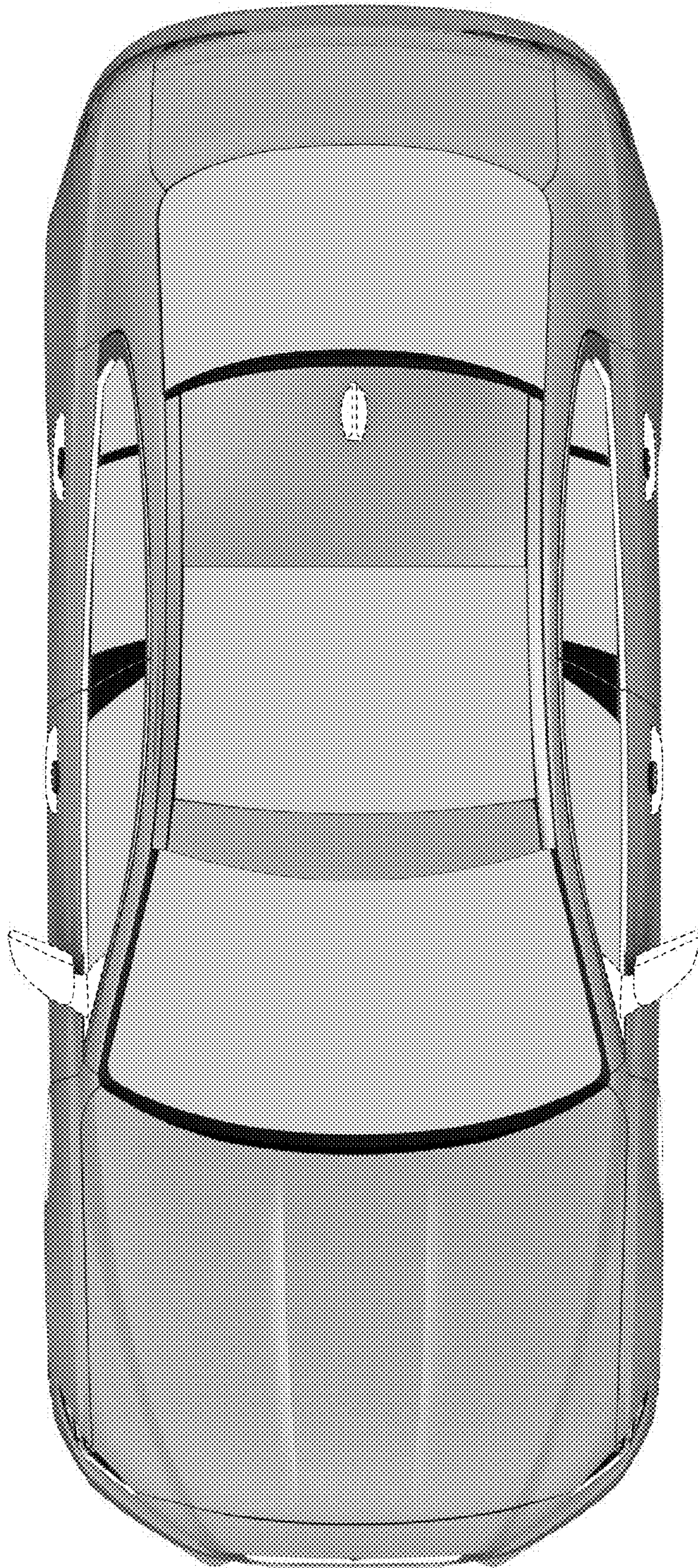

FIG. 21



FIG. 22

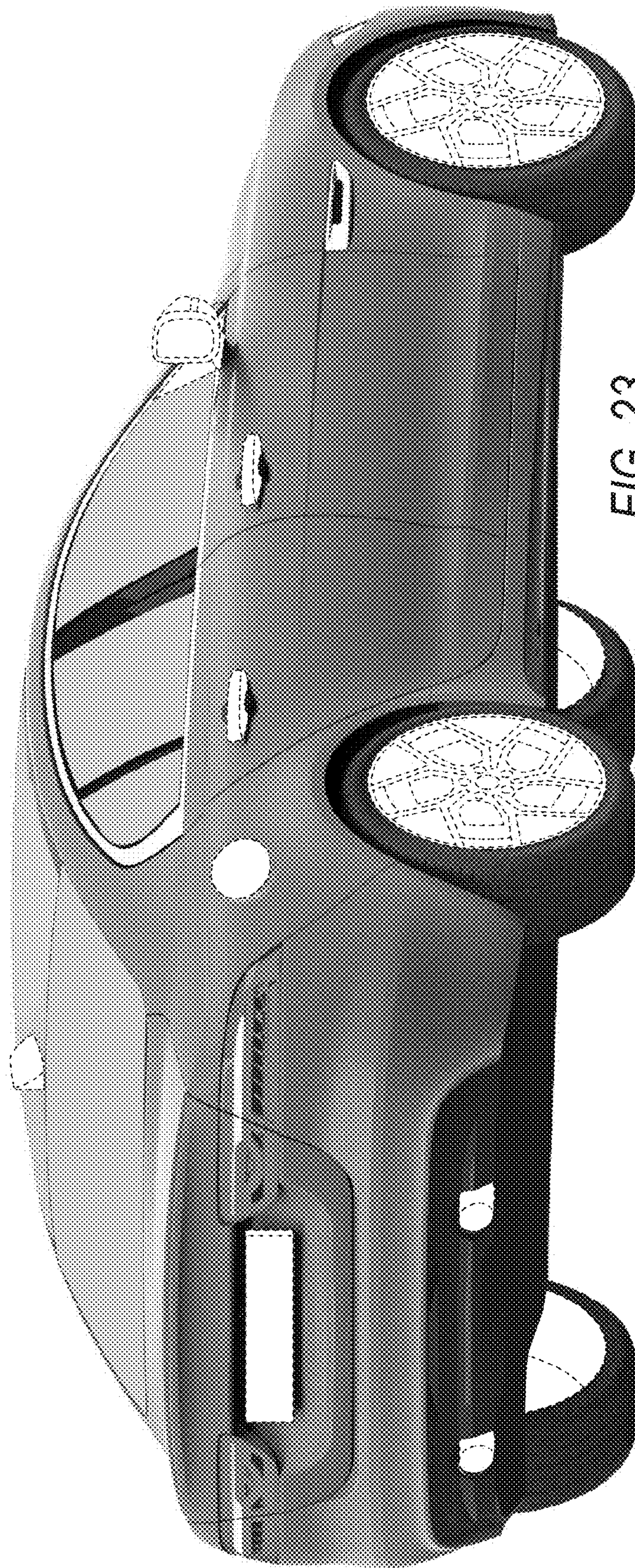

FIG. 23

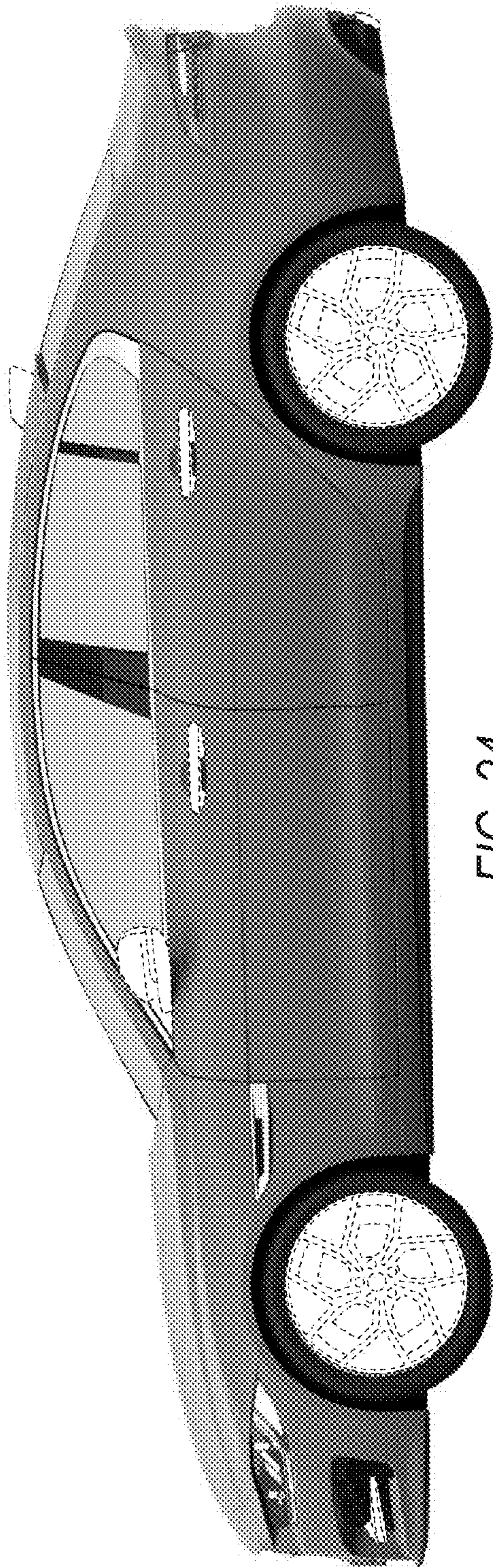

FIG. 24

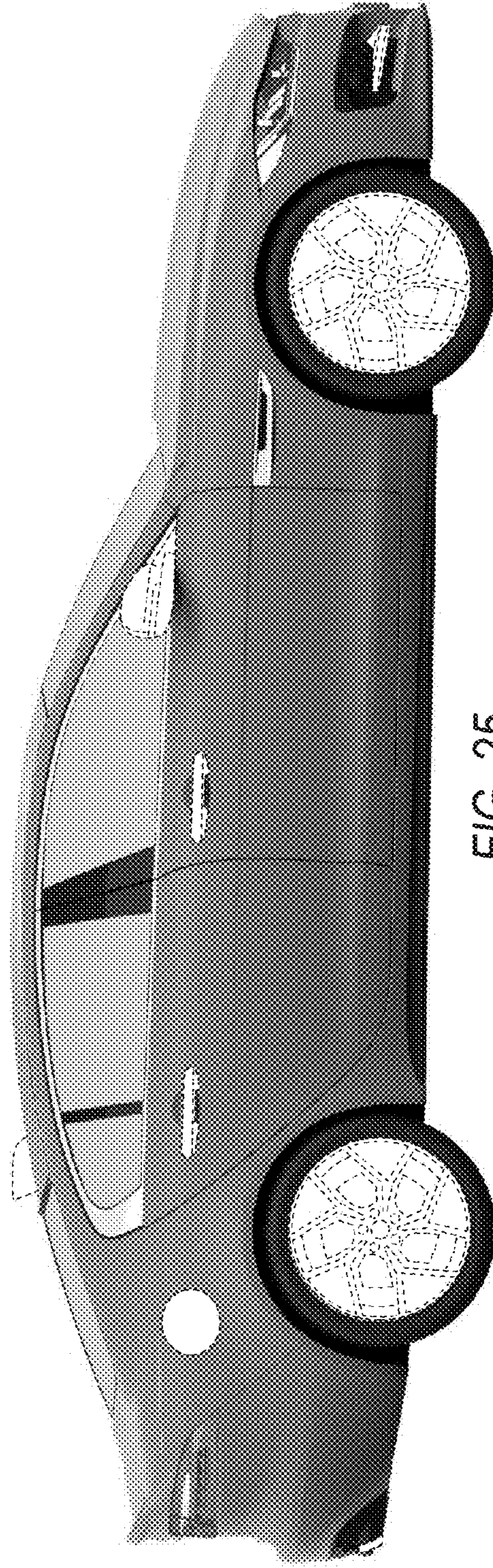

FIG. 25



FIG. 26



FIG. 27

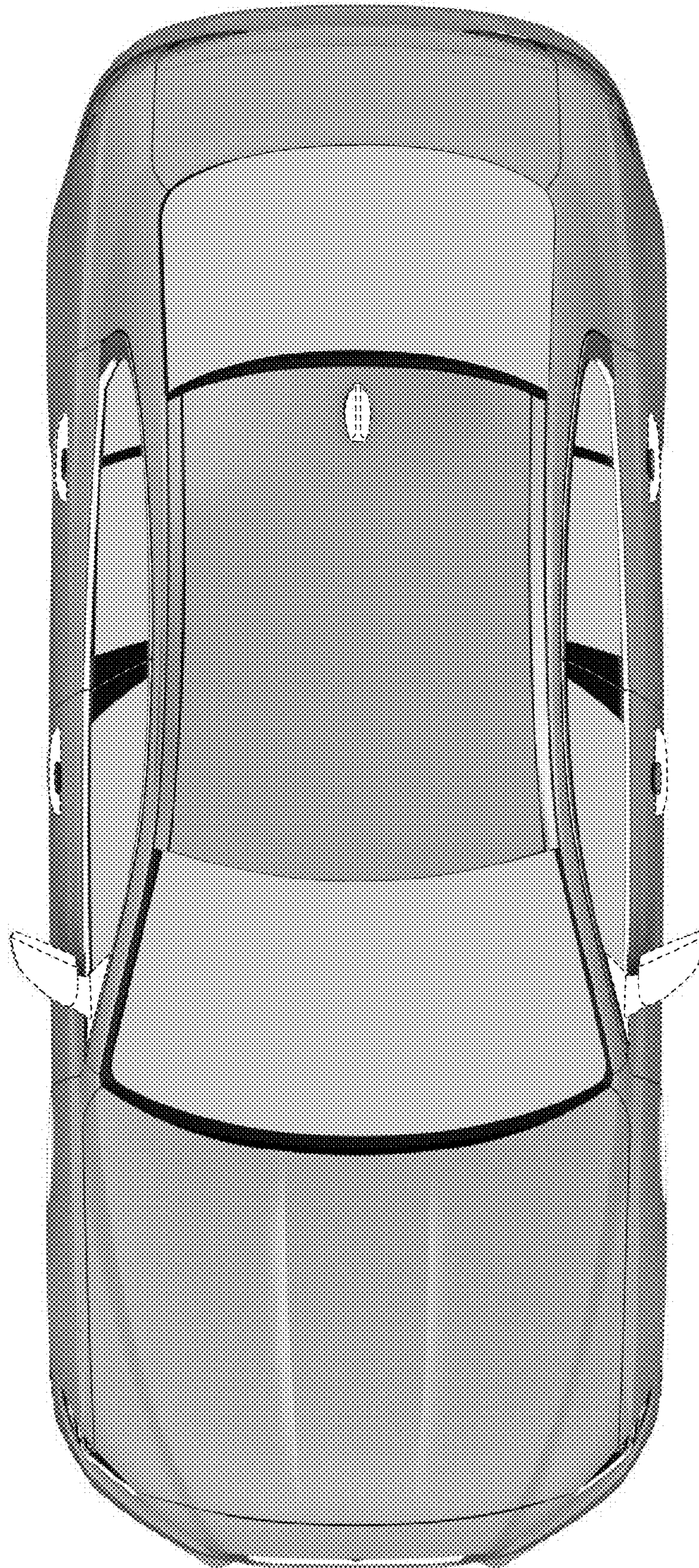

FIG. 28