

US00D758872S

(12) **United States Design Patent**  
**Blake et al.**

(10) **Patent No.:** **US D758,872 S**  
(45) **Date of Patent:** **\*\* Jun. 14, 2016**

(54) **CONTAINER**

(71) Applicant: **Conopco, Inc.**, Englewood Cliffs, NJ (US)

(72) Inventors: **Stephen John Blake**, London (GB); **Josephine Telesca Daoust**, Englewood Cliffs, NJ (US); **Nicholas Hammitt**, Englewood Cliffs, NJ (US); **Peter James Hayes**, London (GB); **Benjamin James Lambert**, London (GB); **Gareth Frederick Jones**, Trumbull, CT (US)

(73) Assignee: **Conopco, Inc.**, Englewood Cliffs, NJ (US)

(\*\*) Term: **14 Years**

(21) Appl. No.: **29/467,712**

(22) Filed: **Sep. 23, 2013**

(51) **LOC (10) Cl.** ..... **09-01**

(52) **U.S. Cl.**  
USPC ..... **D9/542**; D9/551; D9/558; D9/449

(58) **Field of Classification Search**  
USPC ..... D9/516, 529-530, 542-543, 551-552, D9/558, 571, 574, 449; 215/379, 381-382, 215/384; 220/660, 662, 669

See application file for complete search history.

(56) **References Cited**

**U.S. PATENT DOCUMENTS**

D177,570 S	5/1956	James	
D199,766 S *	12/1964	Lorenzen	D9/542
D226,174 S *	1/1973	Osborn	D9/542
D234,911 S *	4/1975	Stevens	D9/529
D235,032 S *	4/1975	Atkins	D9/529 X
D305,300 S *	1/1990	Kraft	D9/542 X
D309,714 S *	8/1990	Biesecker	D9/542
D317,121 S *	5/1991	Crawford	D9/563 X

D333,435 S	2/1993	Blair	
D343,793 S *	2/1994	Crawford	D9/558 X
D352,242 S	11/1994	Crawford	
D408,740 S *	4/1999	Jones	D9/574 X
D412,664 S *	8/1999	Hirst	D9/529 X
D413,067 S *	8/1999	Haley	D9/539
D427,913 S *	7/2000	Davies	D9/449
D446,459 S *	8/2001	Weber	D9/542 X
D480,003 S *	9/2003	Blades	D9/529
D503,889 S	4/2005	Yeung	
D529,814 S *	10/2006	Winkler	D9/563
D532,312 S *	11/2006	Conway	D9/551 X
D537,355 S *	2/2007	Brauner	D9/563 X
D540,176 S *	4/2007	Flurer	D9/447

(Continued)

**OTHER PUBLICATIONS**

Hugo Boss-SKIN packaging, far left pack (photo), May 2, 2008 (online), [retrieved on Jan. 4, 2016]. Retrieved from the Internet <http://www.packagingoftheworld.com/2008/04/hugo-boss-skin.html>.

(Continued)

*Primary Examiner* — Carol P Rademaker

(74) *Attorney, Agent, or Firm* — Karen E. Klumas

(57) **CLAIM**

The ornamental design for a container, as shown and described.

**DESCRIPTION**

FIG. 1 is a top front, right side perspective view of our container;

FIG. 2 is a front elevational view thereof;

FIG. 3 is a rear elevational view thereof;

FIG. 4 is a left side elevational view thereof;

FIG. 5 is a right side elevational view thereof;

FIG. 6 is a top plan view thereof; and,

FIG. 7 is a bottom plan view thereof.

**1 Claim, 3 Drawing Sheets**

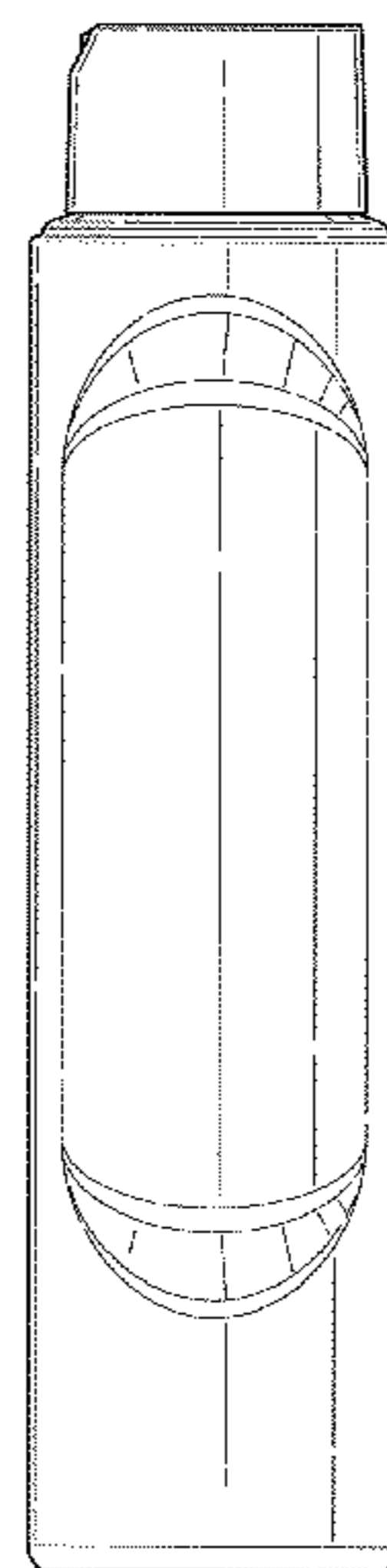
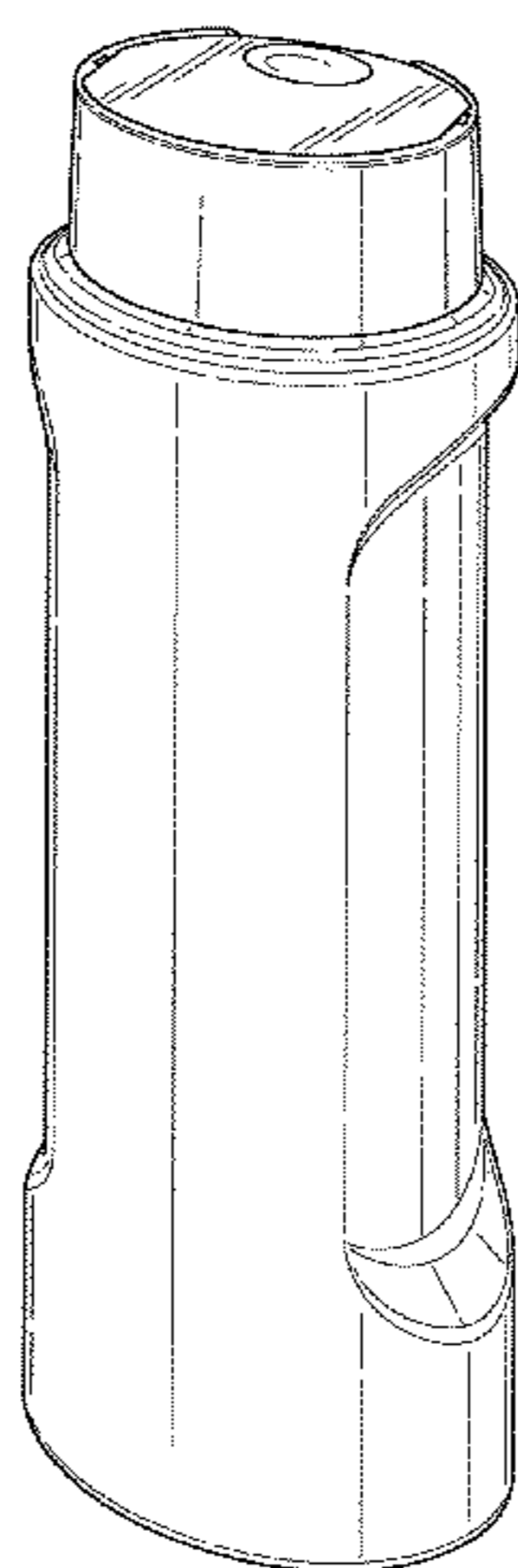

(56)

References Cited

U.S. PATENT DOCUMENTS

D546,189 S	7/2007	Costello	
D561,035 S	* 2/2008	Leslie .....	D9/537
D578,394 S	* 10/2008	Shurtleff .....	D9/516
D585,751 S	* 2/2009	Dombrowski .....	D9/529
D593,866 S	* 6/2009	Dombrowski .....	D9/542
D599,953 S	9/2009	Gibson	
D609,097 S	2/2010	Almstead, Jr.	
D641,635 S	* 7/2011	Wang Treadway .....	D9/558 X
D641,636 S	* 7/2011	Wang Treadway .....	D9/558 X
D651,519 S	1/2012	Gibson	
D662,422 S	* 6/2012	Avakian .....	D9/435
D669,782 S	10/2012	Hoffman	
D669,783 S	10/2012	Hoffman	
D692,303 S	10/2013	Rhodes	
D712,261 S	9/2014	Humm	

OTHER PUBLICATIONS

Hugo Boss-SKIN packaging, third pack from left (photo), May 2, 2008 (online), [retrieved on Jan. 4, 2016]. Retrieved from the Internet <http://www.packagingoftheworld.com/2008/04/hugo-boss-skin.html>.

Hugo Boss-SKIN packaging, second pack from right (photo), May 2, 2008 (online), [retrieved on Jan. 4, 2016]. Retrieved from the Internet <http://www.packagingoftheworld.com/2008/04/hugo-boss-skin.html>.

Hugo Boss Skin Shine Control gel moisturizer pack (photo) from Covin, Tim, "A Seismic Shift", Packaging Today, May 2, 2009 (online), [retrieved on Jan. 1, 2016]. Retrieved from the Internet <http://www.packagingtoday.co.uk/features/featurea-seismic-shift/> and [http://www.packagingtoday.co.uk/uploads/pictures/web/e/v/e/boss\\_pump\\_3q\\_300dpi.jpg](http://www.packagingtoday.co.uk/uploads/pictures/web/e/v/e/boss_pump_3q_300dpi.jpg).

\* cited by examiner

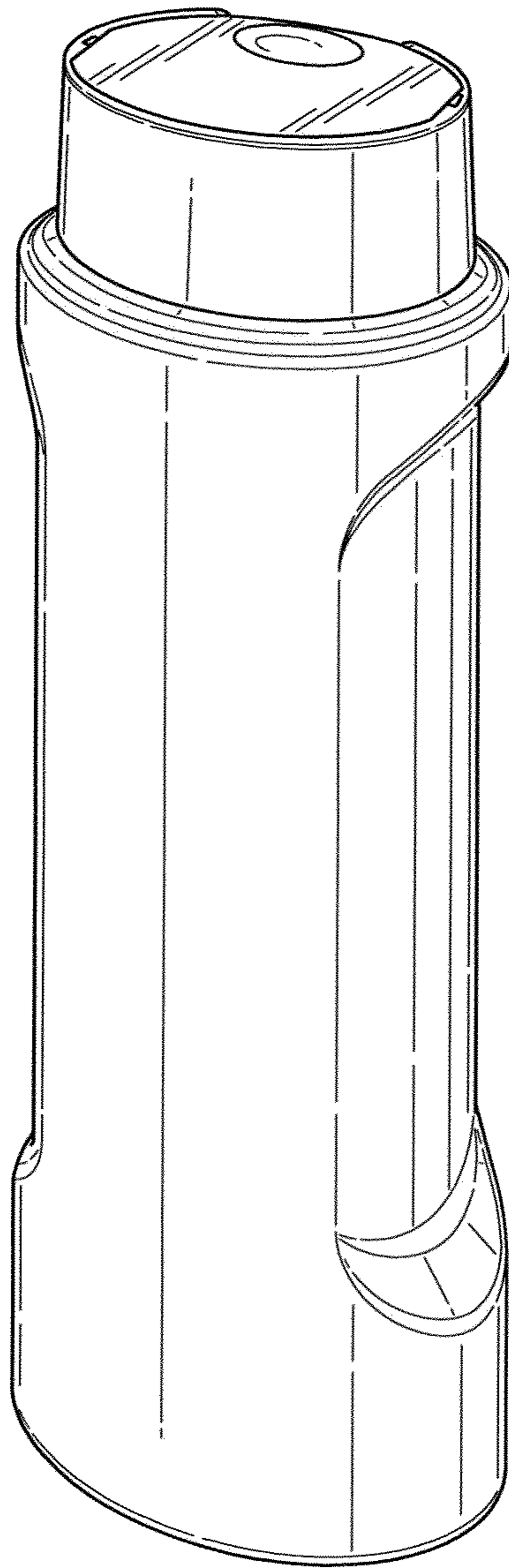

Fig. 1

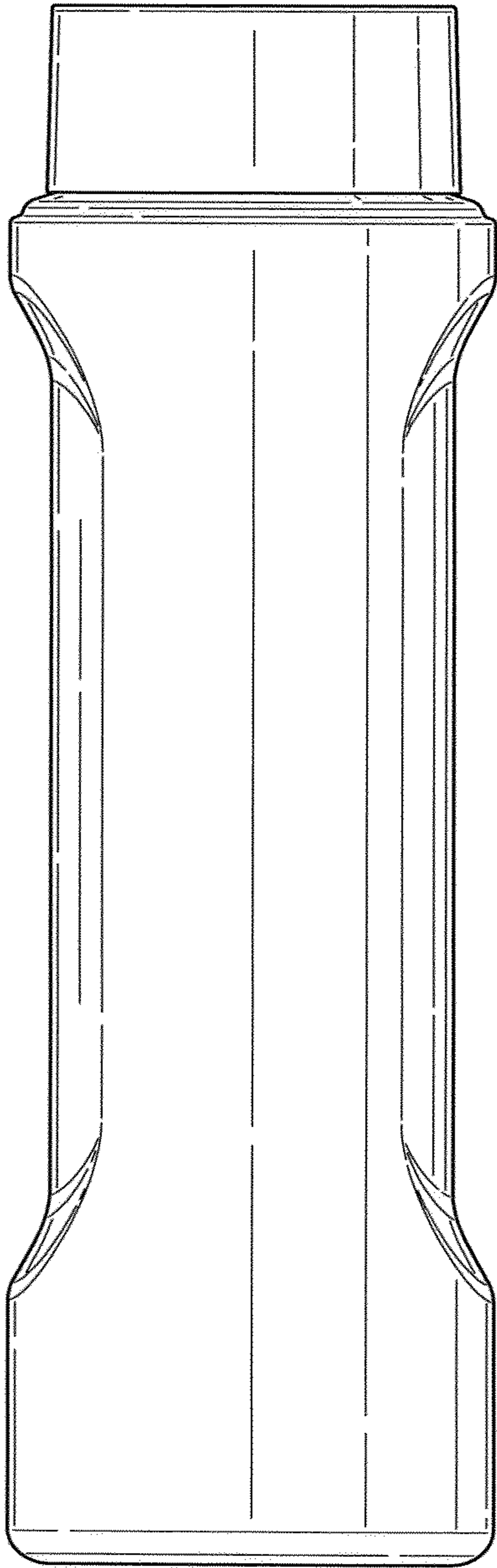

Fig. 2

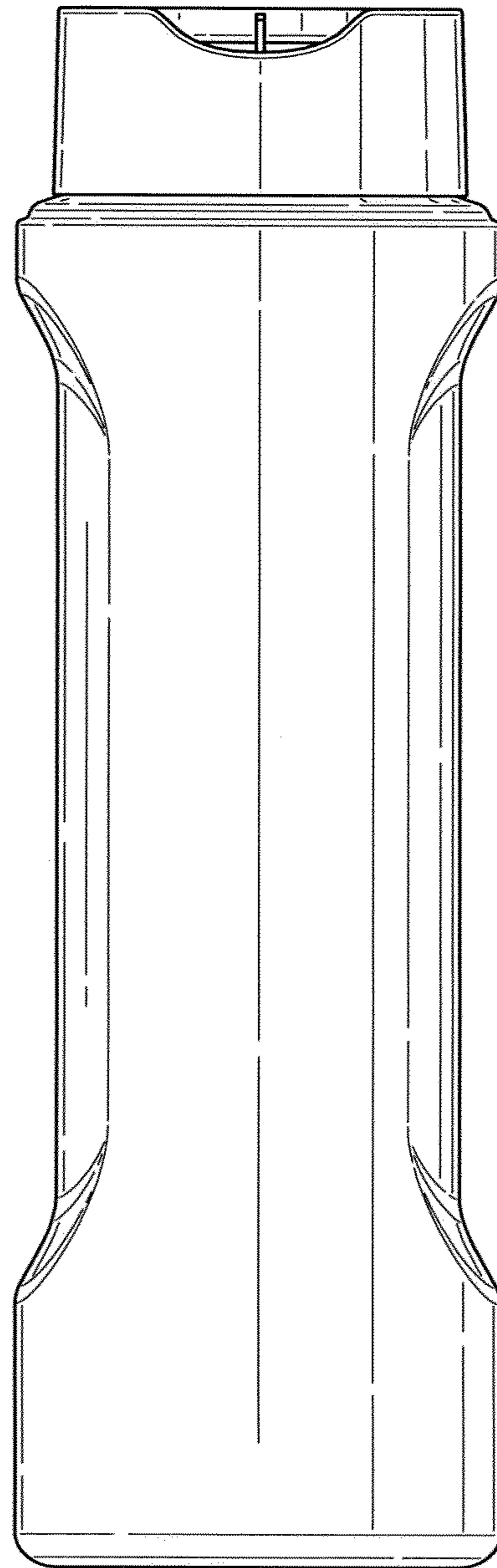

Fig. 3

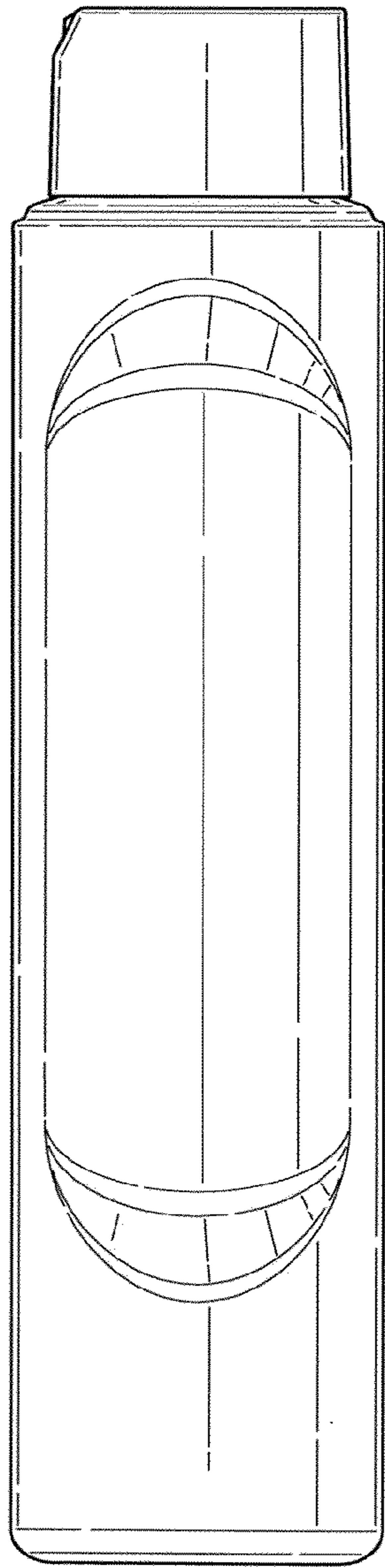

Fig. 4

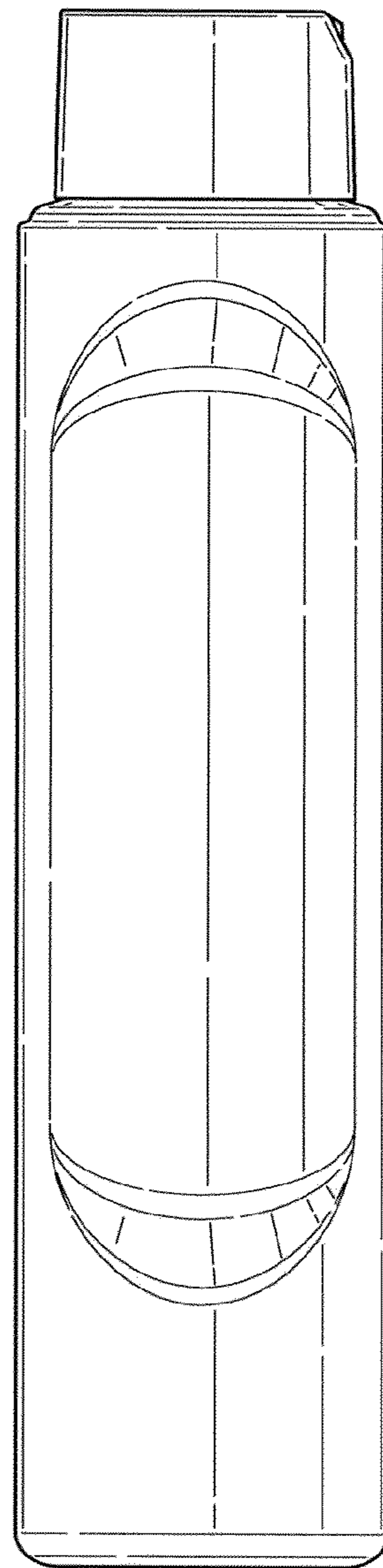

Fig. 5

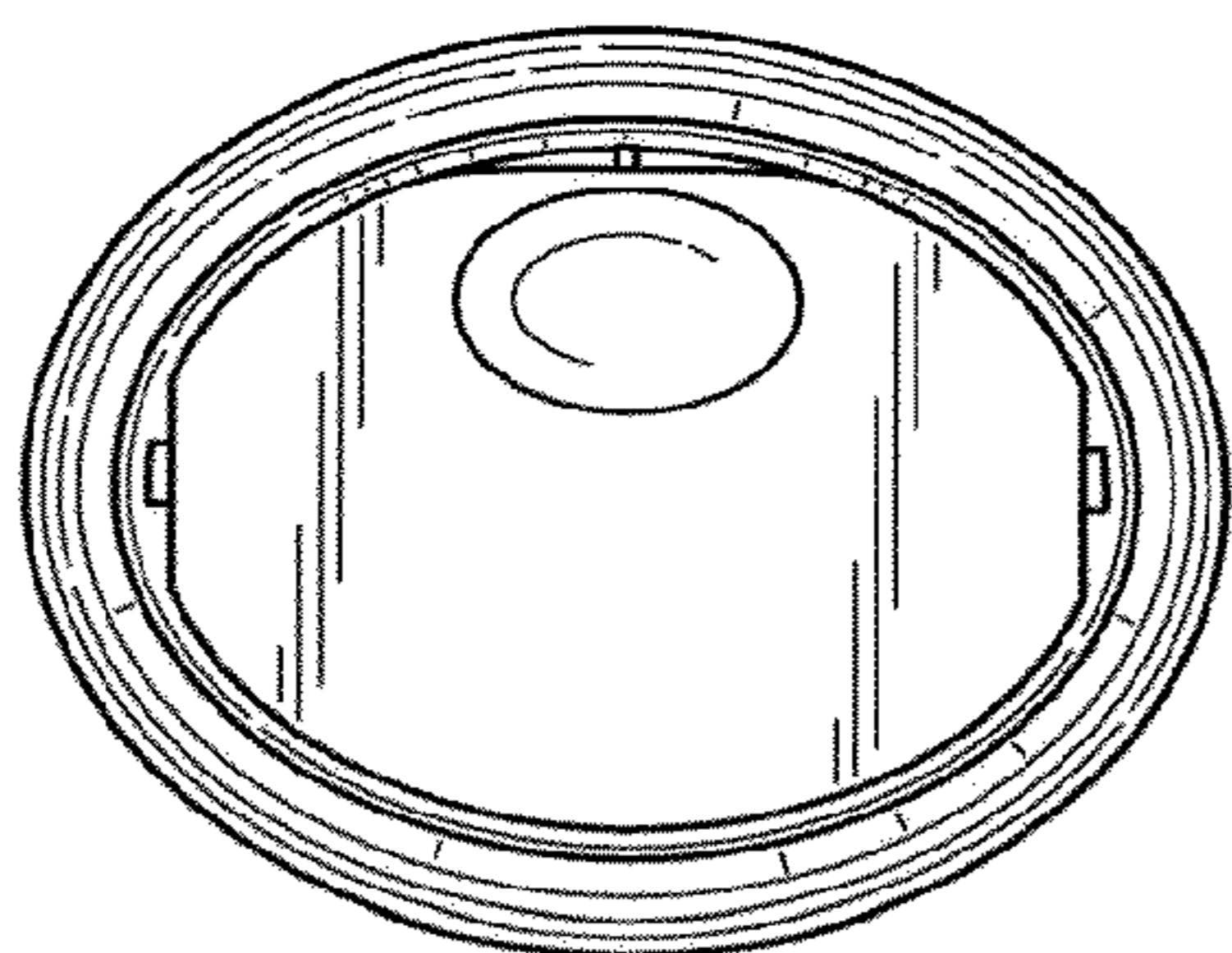

Fig. 6

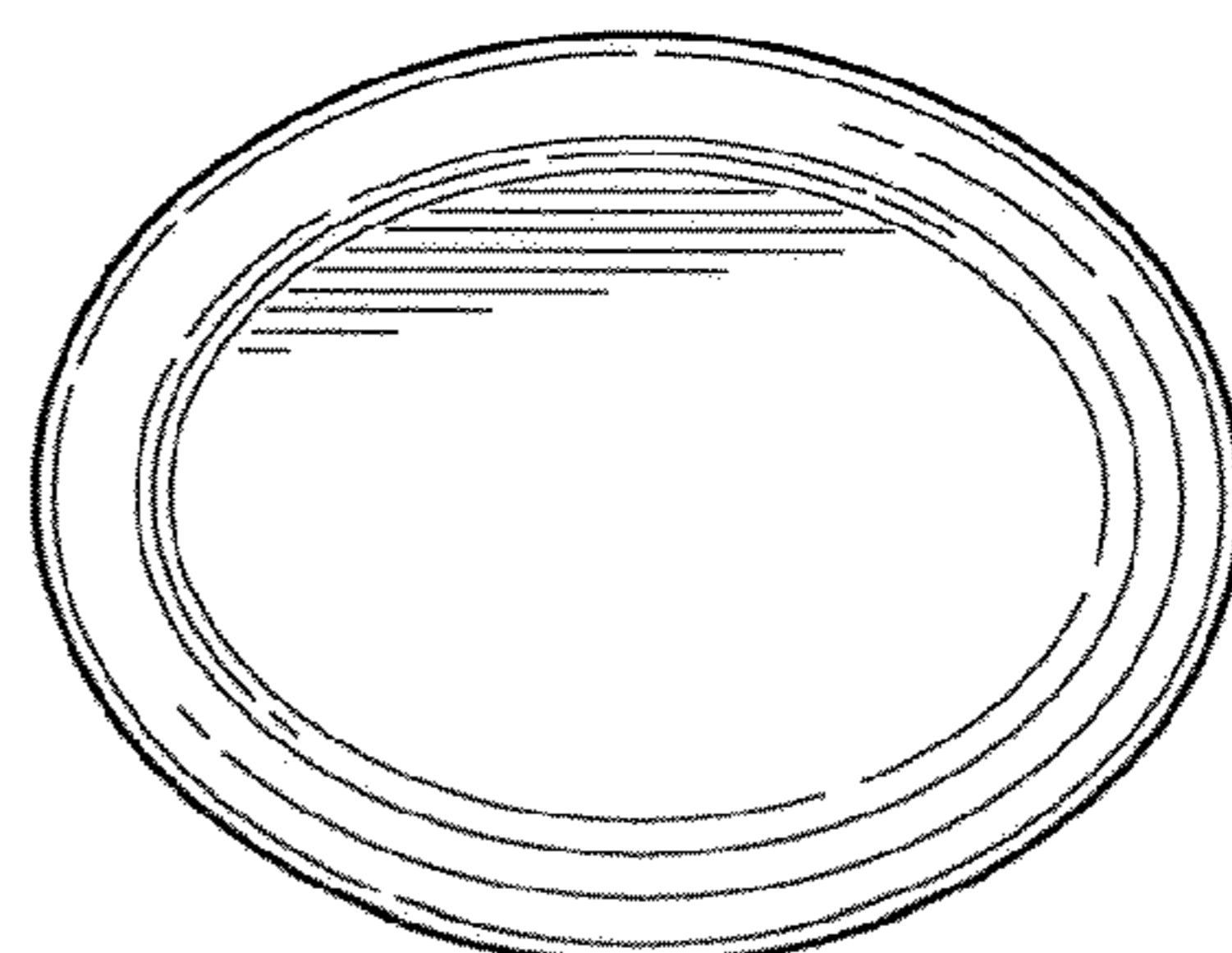

Fig. 7