

US00D758869S

(12) **United States Design Patent**
Blake et al.

(10) **Patent No.:** **US D758,869 S**

(45) **Date of Patent:** **** Jun. 14, 2016**

(54) **CONTAINER**

(71) Applicant: **Conopco, Inc.**, Englewood Cliffs, NJ
(US)

(72) Inventors: **Stephen John Blake**, London (GB);
Josephine Telesca Daoust, Englewood
Cliffs, NJ (US); **Nicholas Hammitt**,
Englewood Cliffs, NJ (US); **Peter James**
Hayes, London (GB); **Benjamin James**
Lambert, London (GB); **Gareth**
Frederick Jones, Trumbull, CT (US)

(73) Assignee: **Conopco, Inc.**, Englewood Cliffs, NJ
(US)

(**) Term: **14 Years**

(21) Appl. No.: **29/467,715**

(22) Filed: **Sep. 23, 2013**

(51) **LOC (10) Cl.** **09-01**

(52) **U.S. Cl.**
USPC **D9/529**; D9/542; D9/543; D9/551;
D9/558; D9/571; D9/549

(58) **Field of Classification Search**
USPC D9/529–530, 542–543, 551–552, 558,
D9/571, 574, 449; 215/379, 381–382, 384;
220/660, 662, 669

See application file for complete search history.

(56) **References Cited**

U.S. PATENT DOCUMENTS

D199,766 S	12/1964	Lorenzen	
D226,174 S *	1/1973	Osborn	D9/542
D234,911 S *	4/1975	Stevens, Jr.	D9/529
D235,032 S	4/1975	Atlins	
D305,300 S *	1/1990	Kraft	D9/529 X
D309,714 S *	8/1990	Biesecker	D9/542
D317,121 S *	5/1991	Crawford	D9/563 X
D333,435 S	2/1993	Blair	
D343,793 S *	2/1994	Crawford	D9/558 X
D352,242 S *	11/1994	Crawford	D9/516
D370,848 S *	6/1996	Dziersk	D9/542 X

D408,740 S *	4/1999	Jones	D9/574 X
D412,664 S *	8/1999	Hirst	D9/529 X
D413,067 S *	8/1999	Haley	D9/551 X
D427,913 S *	7/2000	Davies	D9/449
D480,003 S *	9/2003	Blades	D9/571 X
D529,814 S *	10/2006	Winkler	D9/563
D532,312 S *	11/2006	Conway	D9/551 X
D537,355 S *	2/2007	Brauner	D9/563 X
D546,189 S *	7/2007	Costello	D9/558 X
D561,035 S *	2/2008	Leslie	D9/552 X
D561,594 S *	2/2008	Condon	D9/529
D578,394 S *	10/2008	Shurtleff	D9/516
D585,751 S *	2/2009	Dombrowski	D9/529
D593,866 S	6/2009	Dombrowski	

(Continued)

OTHER PUBLICATIONS

Hugo Boss-SKIN packaging, far left pack (photo), Apr. 2, 2008 (online), [retrieved on Jan. 4, 2016]. Retrieved from the Internet <http://www.packagingoftheworld.com/2008/04/hugo-boss-skin.html>.

Hugo Boss-SKIN packaging, third pack from left (photo), Apr. 2, 2008 (online), [retrieved on Jan. 4, 2016]. Retrieved from the Internet <http://www.packagingoftheworld.com/2008/04/hugo-boss-skin.html>.

(Continued)

Primary Examiner — Carol P Rademaker

(74) *Attorney, Agent, or Firm* — Karen E. Klumas

(57) **CLAIM**

The ornamental design for a container, as shown and described.

DESCRIPTION

FIG. 1 is a top front, right side perspective view of our container;

FIG. 2 is a front elevational view thereof;

FIG. 3 is a rear elevational view thereof;

FIG. 4 is a left side elevational view thereof;

FIG. 5 is a right side elevational view thereof;

FIG. 6 is a top plan view thereof; and,

FIG. 7 is a bottom plan view thereof.

1 Claim, 4 Drawing Sheets

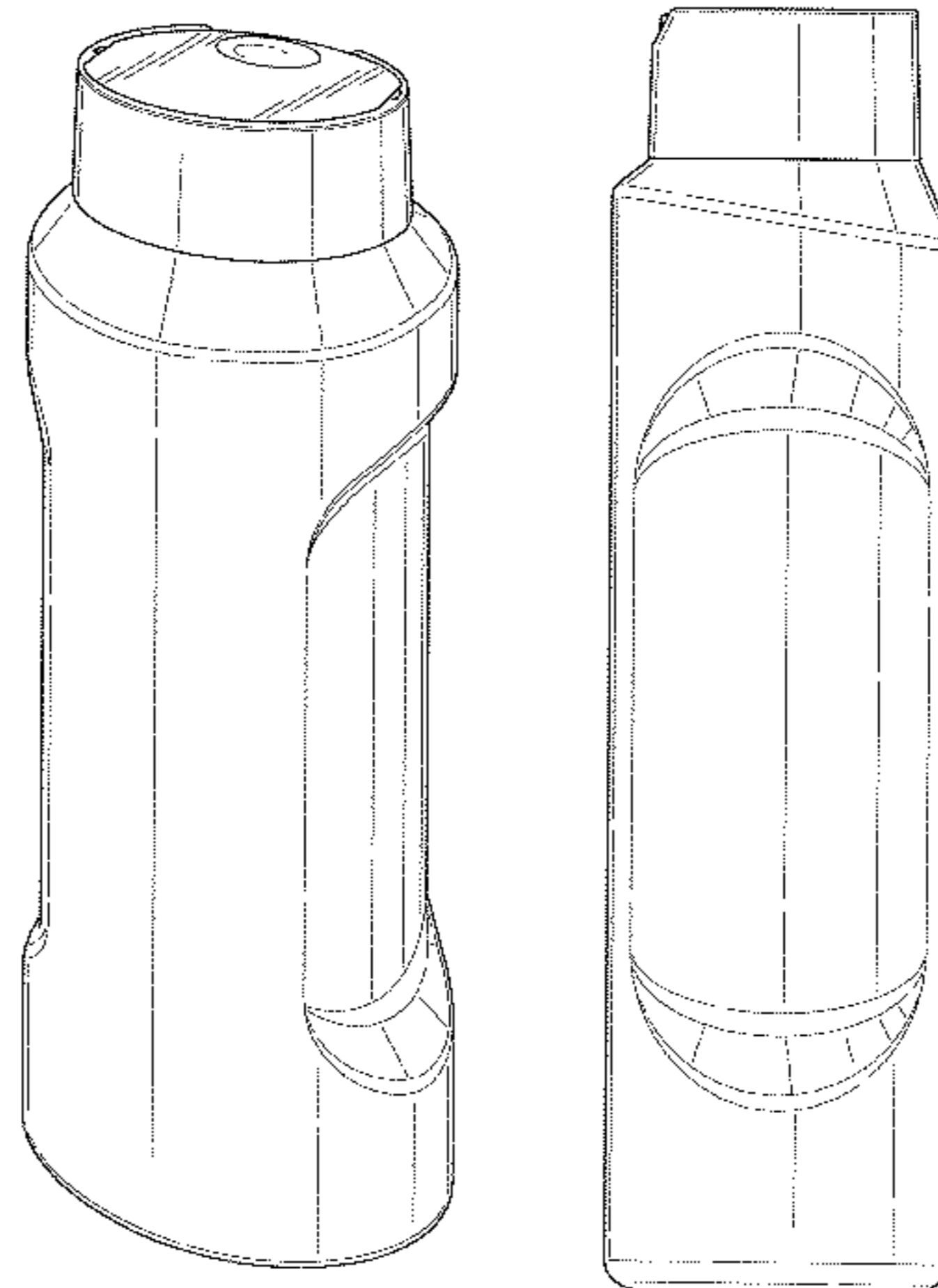

(56)

References Cited

U.S. PATENT DOCUMENTS

D609,097 S 2/2010 Almstead, Jr.
D641,635 S * 7/2011 Wang Treadway D9/571 X
D641,636 S * 7/2011 Wang Treadway D9/558 X
D651,519 S 1/2012 Gibson
D669,782 S 10/2012 Hoffman
D669,783 S 10/2012 Hoffman
D674,282 S * 1/2013 Baldrige D9/449
D692,303 S 10/2013 Rhodes
D712,261 S 9/2014 Humm
D716,147 S * 10/2014 Jordan D9/529
D739,761 S * 9/2015 Zerba D9/571 X

OTHER PUBLICATIONS

Hugo Boss-SKIN packaging, second pack from right (photo), Apr. 2, 2008 (online), [retrieved on Jan. 4, 2016]. Retrieved from the Internet <http://www.packagingoftheworld.com/2008/04/hugo-boss-skin.html>.

Hugo Boss SKIN SHINE CONTROL gel moisturizer pack (photo) from Covin, Tim, "A Seismic Shift", Packaging Today, Apr. 2, 2009 (online), [retrieved on Jan. 4, 2016]. Retrieved from the Internet <http://www.packagingtoday.co.uk/features/featurea-seismic-shift/> and http://www.packagingtoday.co.uk/uploads/pictures/web/e/v/e/boss_pump_3q_300dpi.jpg.

* cited by examiner

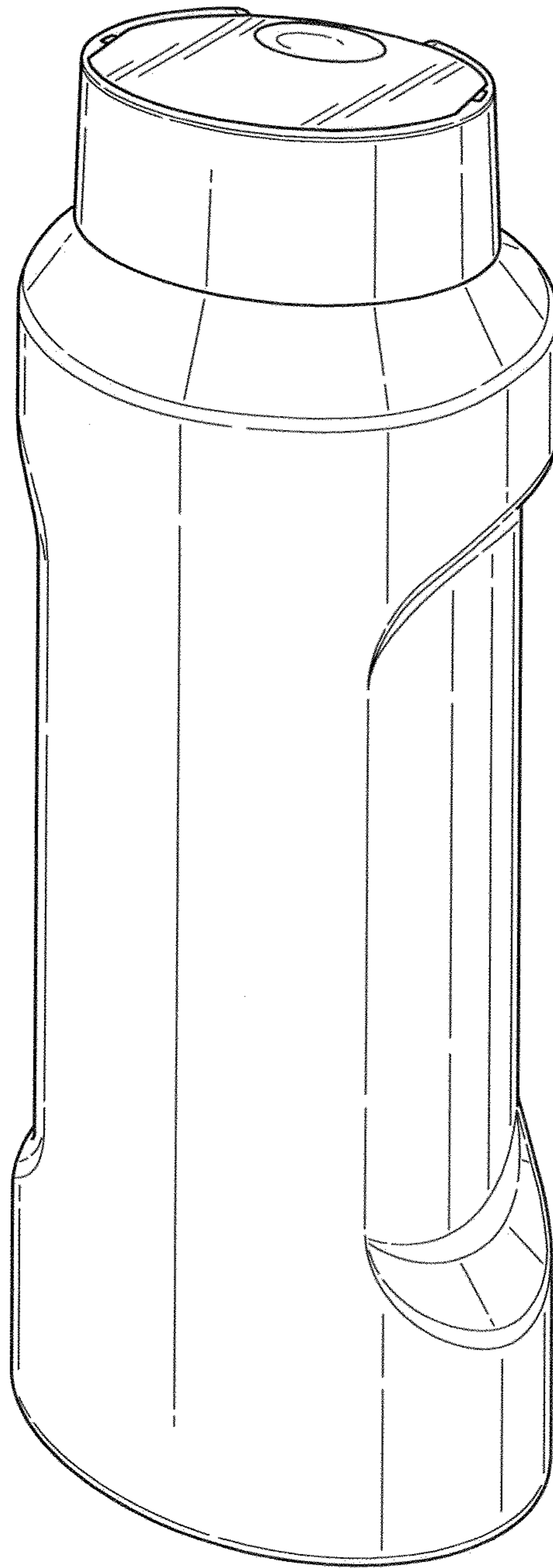

Fig. 1

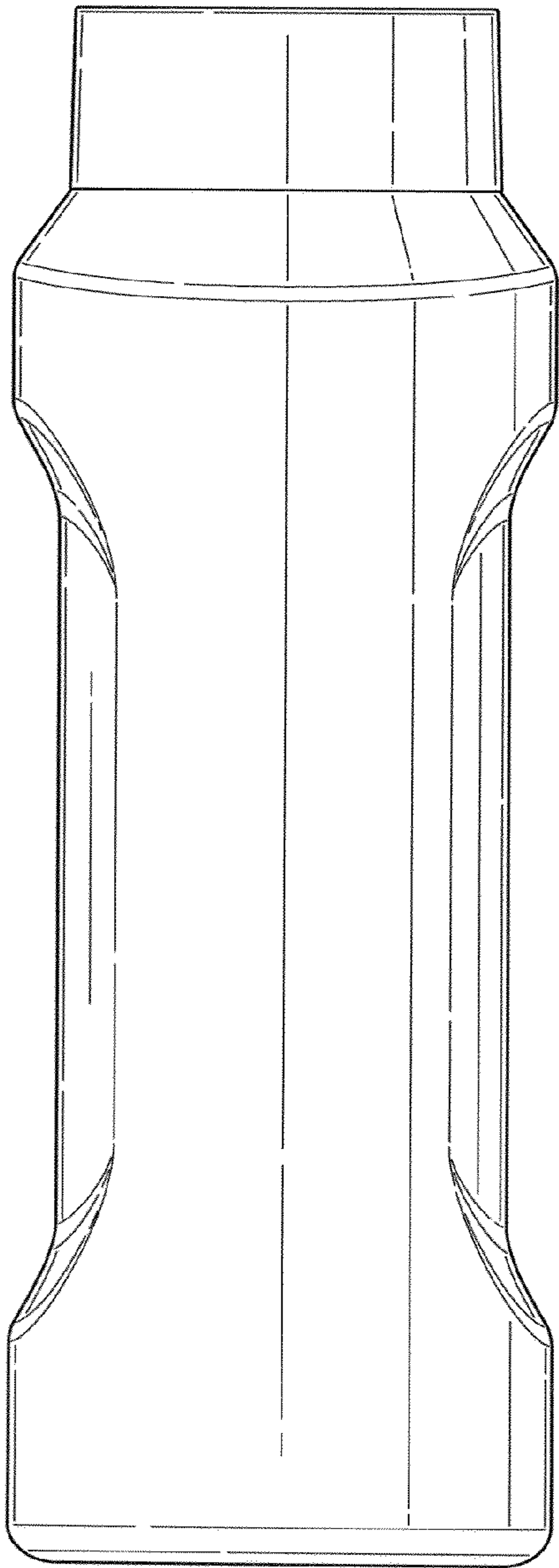

Fig. 2

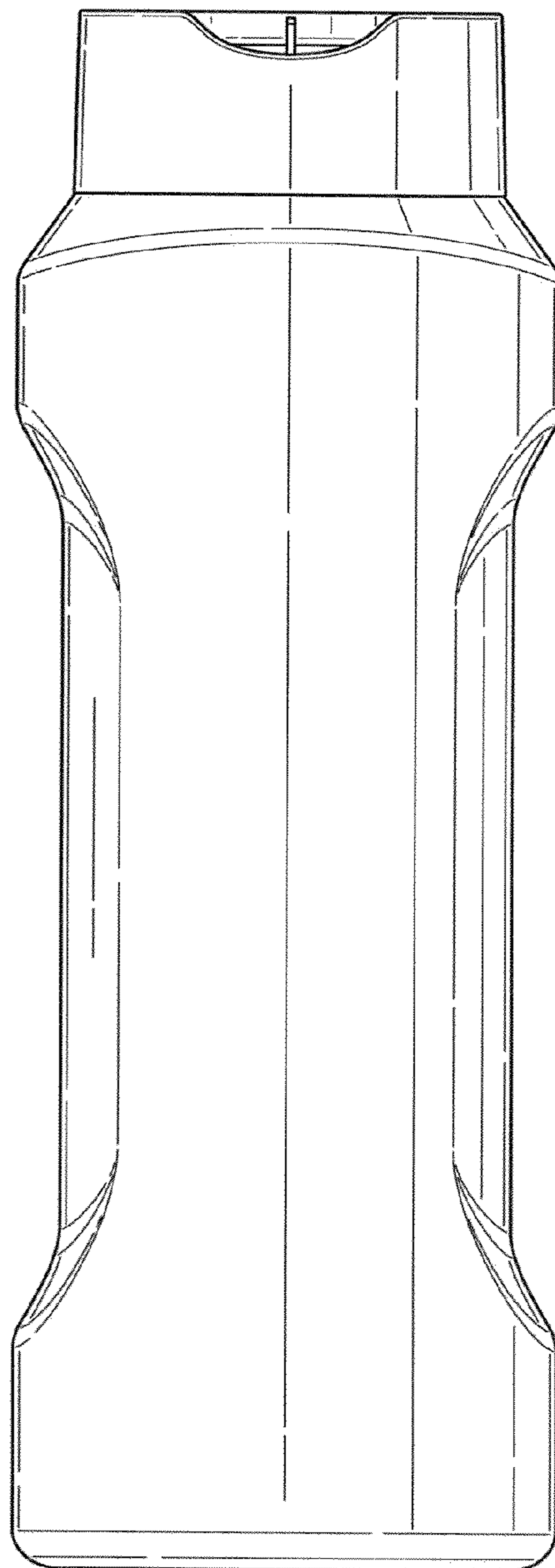

Fig. 3

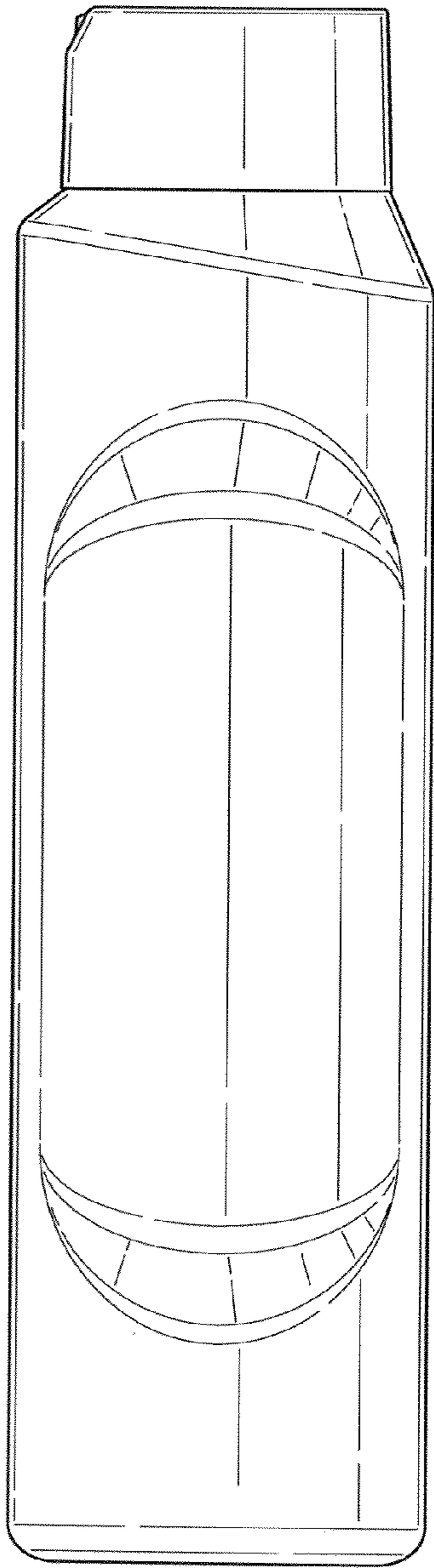

Fig. 4

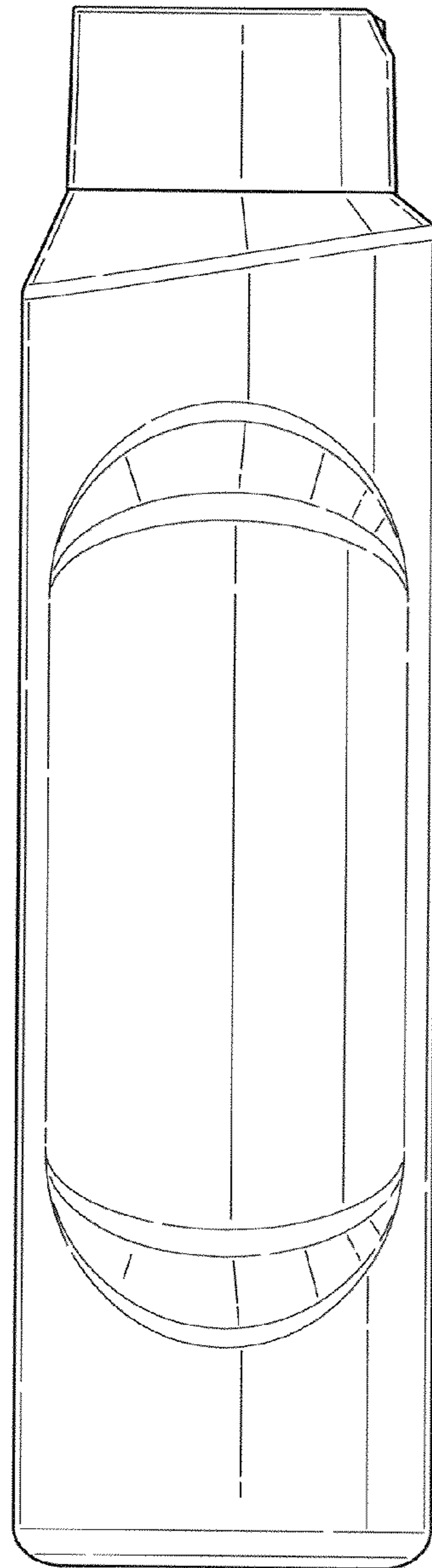

Fig. 5

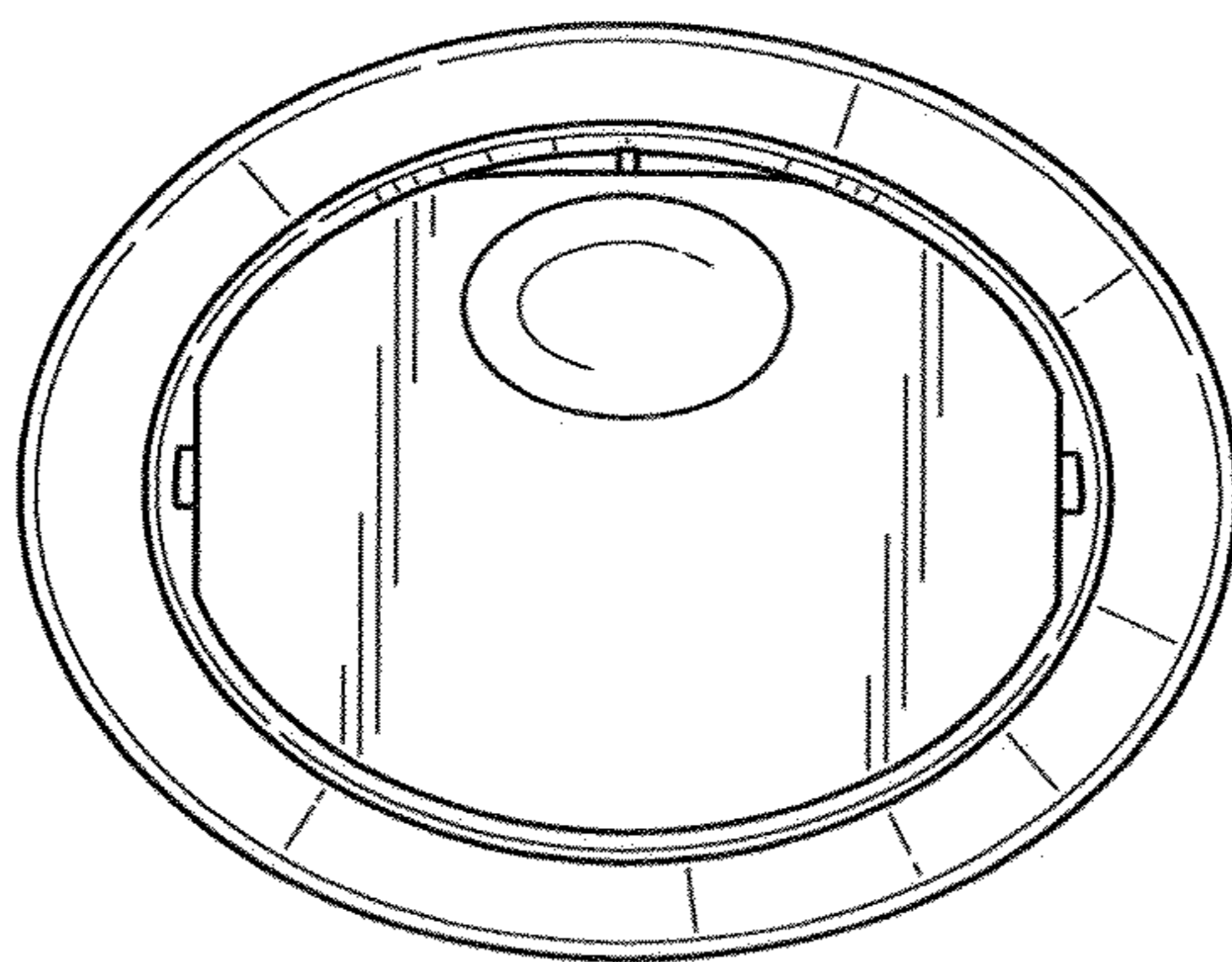

Fig. 6

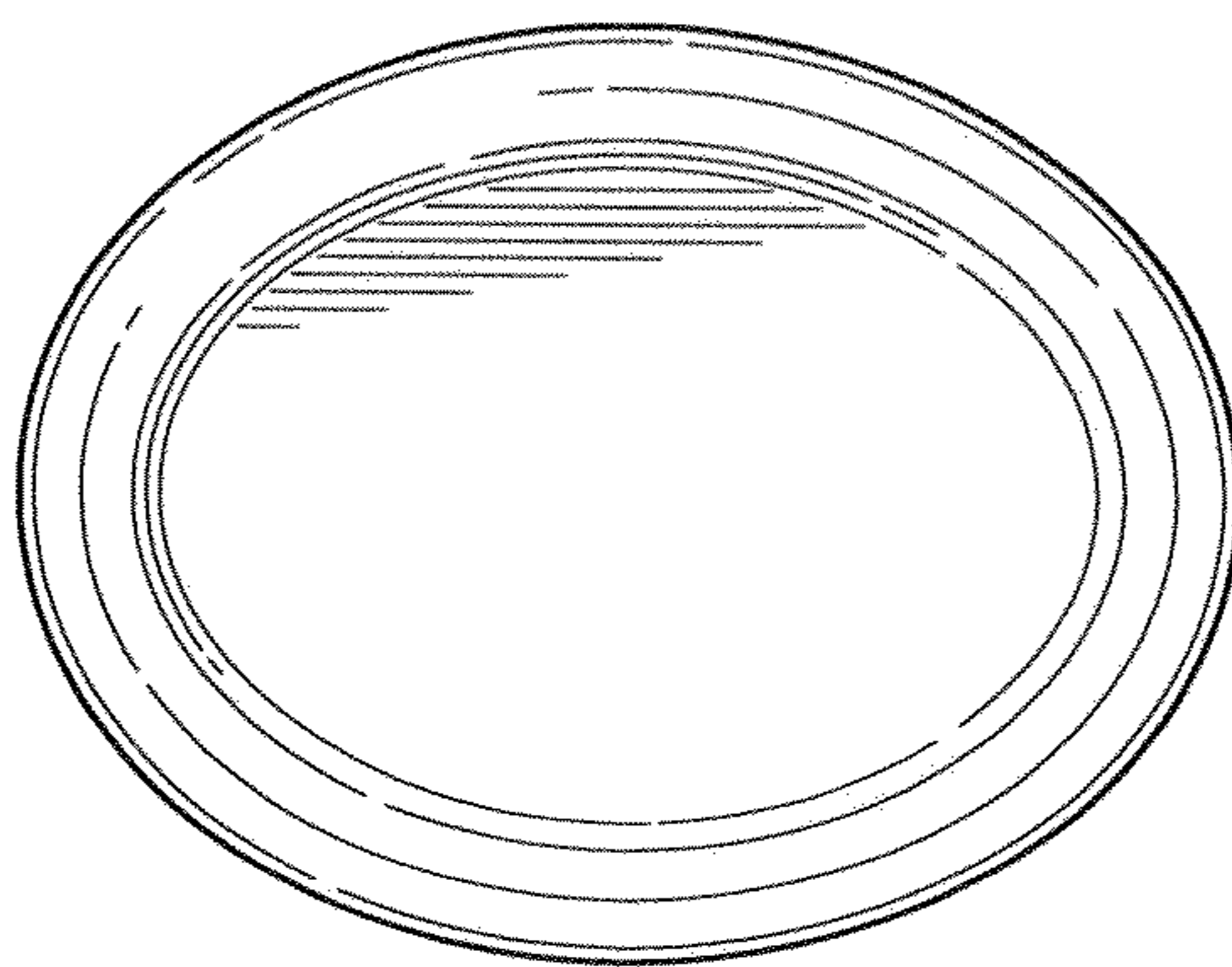

Fig. 7